

Hall Effect Micro Switch IC

Features

- **Micro Power Operation for Battery Applications**
- **Chopper Stabilized Amplifier**
- **Independent of North or South Pole Magnet, Easy for Manufacture**
- **Small Size Package**
- **Lead Free and Green Devices Available (RoHS Compliant)**

General Description

The APX9136, integrated circuit, is an ultra-sensitive, pole independent Hall-effect switch with a latched digital output. A 1.6 volt to 3.5 volt operation and an unique clocking scheme reduce the average operating power requirements, either a north or a south pole of sufficient flux will turn the output on; in the absence of a magnetic field, the output is off. The polarity independence and minimal power requirement allow this device to be easily replaced reed switch for superior for signal conditioning. Advanced CMOS processing is used to take advantage of low-voltage and low-power requirements, VTDFN1.6x1.6-6 package provides an optimized package for most applications.

Applications

- **Micro Switch**
- **Handheld Wireless Application Wake Up Switch**
- **Clamp Shell Type Application Switch**
- **Magnet Switch in Low Duty Cycle Applications**

Pin Configuration

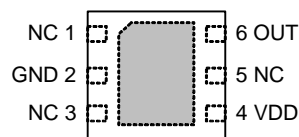

VTDFN1.6X1.6-6 (Top View)

 Exposed Pad
(Do not solder on PCB to reduce SMD stress)

Ordering and Marking Information

<p>APX9136 □□□-□□□</p> <div style="margin-left: 20px;"> <p>└─ Assembly Material</p> <p>└─ Handling Code</p> <p>└─ Temperature Range</p> <p>└─ Package Code</p> </div>	<p>Package Code QF : VTDFN1.6x1.6-6</p> <p>Temperature Range I : -40 to 85 °C</p> <p>Handling Code TR : Tape & Reel</p> <p>Assembly Material G : Halogen and Lead Free Device</p>
<p>APX9136 QF: X36 • X</p>	<p>X - Date Code</p>

Note: ANPEC lead-free products contain molding compounds/die attach materials and 100% matte tin plate termination finish; which are fully compliant with RoHS. ANPEC lead-free products meet or exceed the lead-free requirements of IPC/JEDEC J-STD-020D for MSL classification at lead-free peak reflow temperature. ANPEC defines "Green" to mean lead-free (RoHS compliant) and halogen free (Br or Cl does not exceed 900ppm by weight in homogeneous material and total of Br and Cl does not exceed 1500ppm by weight).

ANPEC reserves the right to make changes to improve reliability or manufacturability without notice, and advise customers to obtain the latest version of relevant information to verify before placing orders.

Absolute Maximum Ratings $T_A = 25^\circ\text{C}$ unless otherwise noted

Symbol	Parameter	Rating	Unit
V_{DD}	Supply Voltage	5	V
V_{OUT}	Output Voltage	5	V
I_{OUT}	Output Current	± 1	mA
T_J	Junction Temperature Range	150	°C
T_{STG}	Storage Temperature Range	-65 to +150	

Thermal Characteristics

Symbol	Parameter	Typical Value	Unit
θ_{JA}	Junction-to-Ambient Resistance in Free Air ^(Note 1) VTDFN1.6x1.6-6	167	°C /W
P_D	Power Dissipation, $T_A=25^\circ\text{C}$ VTDFN1.6x1.6-6	0.6	W

Note 1: θ_{JA} is measured with the component mounted on a high effective thermal conductivity test board in free air.

Electrical Characteristics $T_A = 25^\circ\text{C}$, $V_{DD}=3\text{V}$ unless otherwise noted

Symbol	Characteristic	Test Conditions	APX9136			Unit
			Min.	Typ.	Max.	
V_{DD}	Supply Voltage Range	Operating	1.6	-	3.5	V
I_{DD}	Supply Current	Average	-	5	10	μA
		Awake	-	1.2	2	mA
		Sleep	-	2	8	μA
I_{OFF}	Output Leakage Current	$V_{OUT}=3.5\text{V}$, $B_{RPN}<B<B_{RPS}$	-	-	1.0	μA
V_{OH}	Output High Voltage	$I_{OUT}=-1\text{mA}$	$V_{DD} - 0.4$	-	-	V
V_{OL}	Output Low Voltage	$I_{OUT}=1\text{mA}$	-	20	40	mV
t_{awake}	Wake up Time		-	180	-	μs
t_{period}	Period		-	60	-	ms
d.c.	Duty Cycle		-	0.3	-	%
f_c	Chopping Frequency		-	11	-	kHz

Magnetic Characteristics $T_A = 25^\circ\text{C}$, $V_{DD}=1.8\text{V}$ unless otherwise noted

Symbol	Characteristic	Test Conditions	APX9136			Unit
			Min.	Typ.	Max.	
B_{OPS}	Operate Points		-	30	45	G
B_{OPN}			-45	-30	-	G
B_{RPS}	Release Points		10	20	-	G
B_{RPN}			-	-20	-10	G
B_{hys}	Hysteresis		-	10	-	G

Typical Operating Characteristics

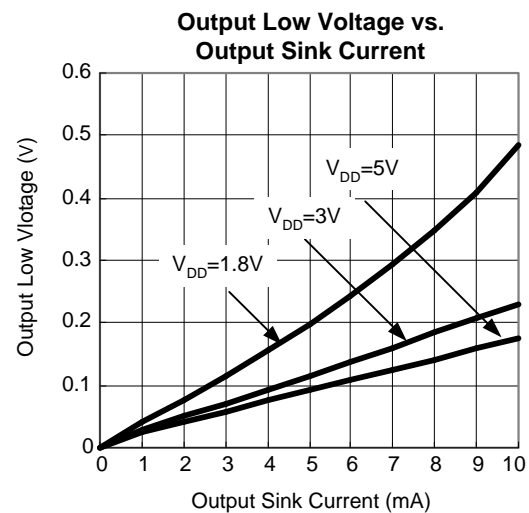
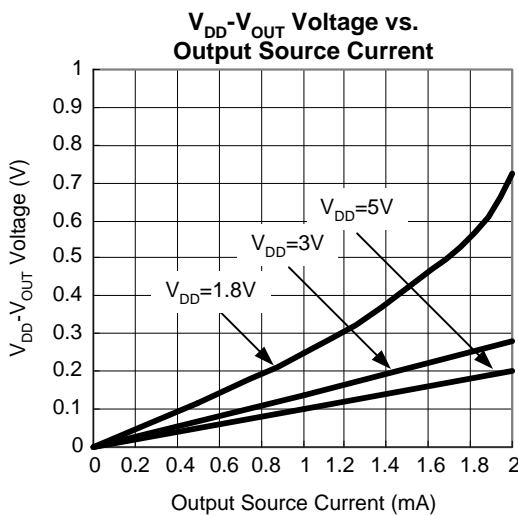
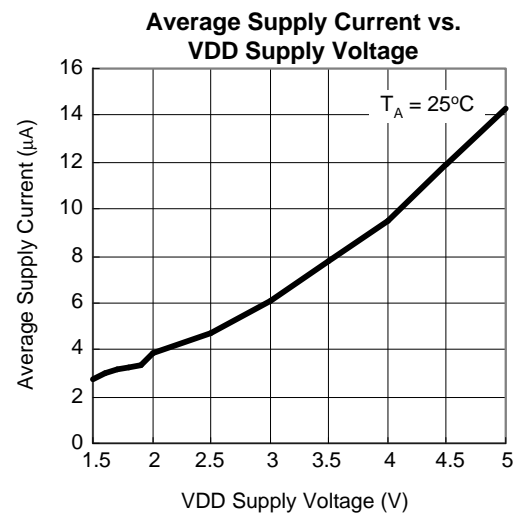
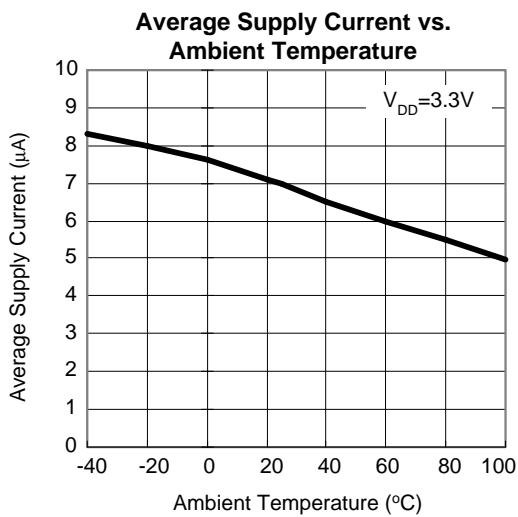
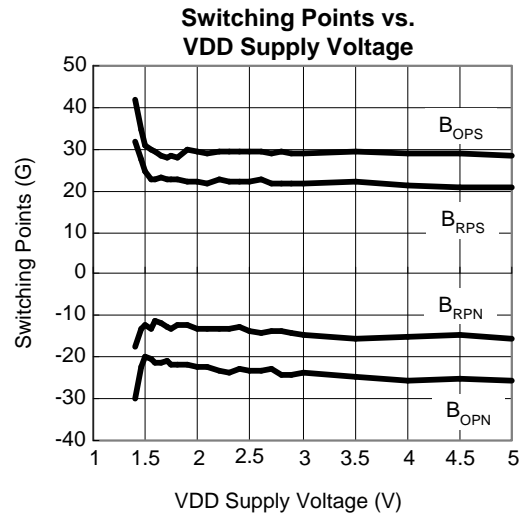
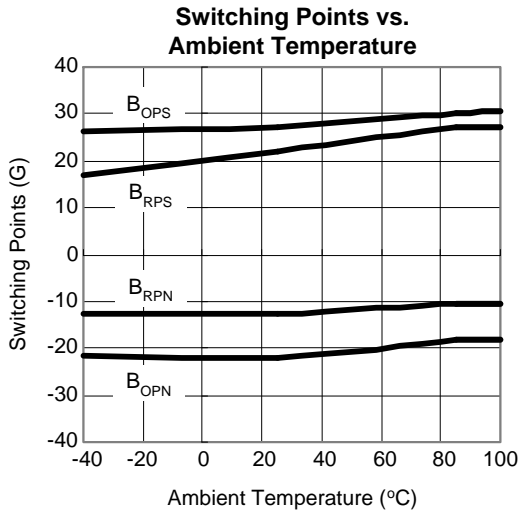

Operating Waveforms

Output Switch Waveform

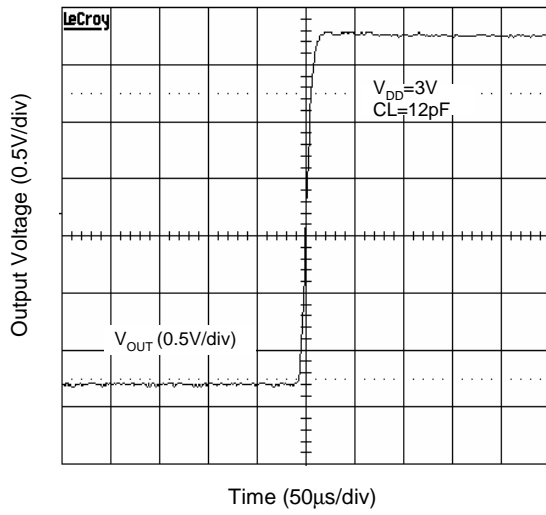

Output Switch Waveform

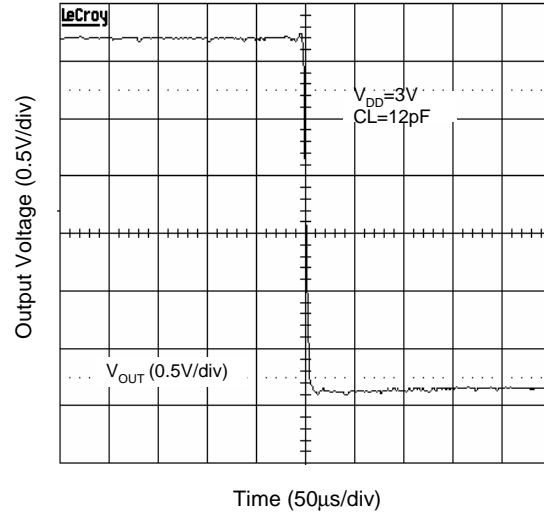

Pin Description

PIN		FUNCTION
NO.	NAME	
1, 3, 5	NC	No Connection.
2	GND	Ground Connection.
4	VDD	Power input.
6	VOUT	When a magnetic field enters the hall element and exceeds the operate point BOPS (or less than BOPN), the output turns on (output is low). When the magnetic field is below the release point BRPS (or above BRPN), the output turns off (output is high).

Block Diagram

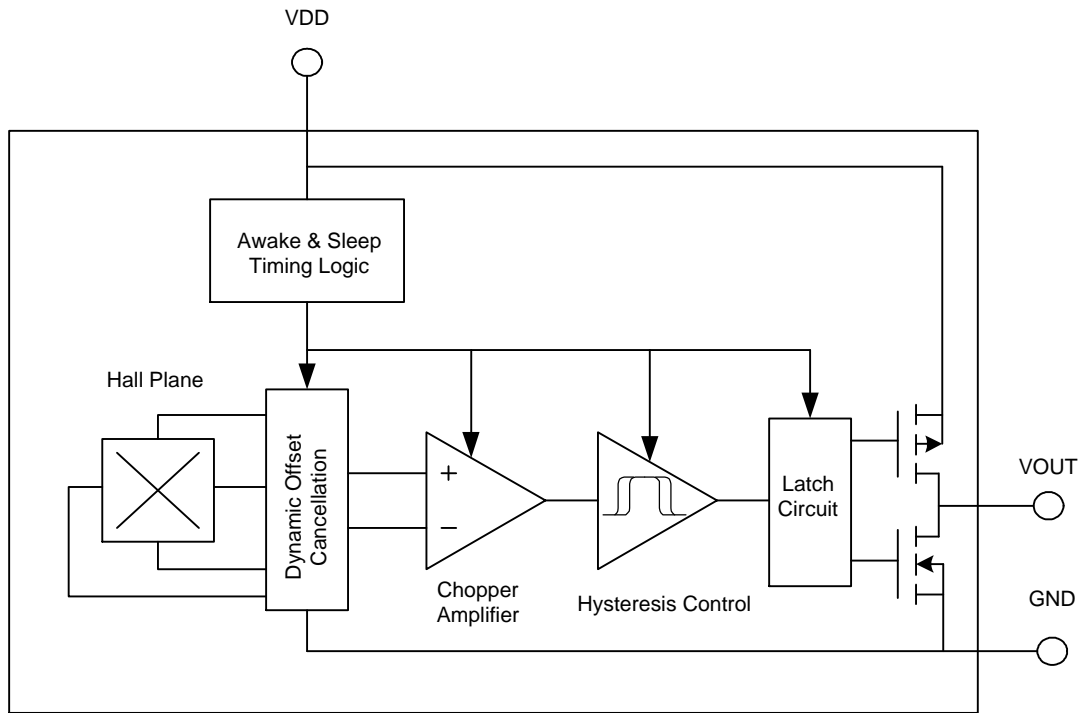

Typical Application Circuit

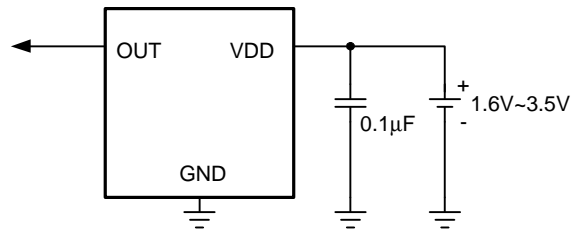

Function Description

Operation

The output of APX9136 switches low (turn-on) when in presence of strong flux density facing the marked side of package exceeds the operate point B_{OPS} (or is less than B_{OPN}). After turn-on, the output is capable of sinking up to 1mA and the output voltage is low (turn-on). In absence of flux density is below the release point B_{RPS} (or increases above B_{RPN}), the APX9136 output switches high (turns off). After turn-off, the output is capable of sourcing up to 1mA and the output voltage is high (turn-off). The difference in the magnetic operated and released point is the hysteresis (B_{hys}) of the device. This built-in hysteresis allows clean switching of the output even in the presence of external mechanical bouncing vibration and electrical noise.

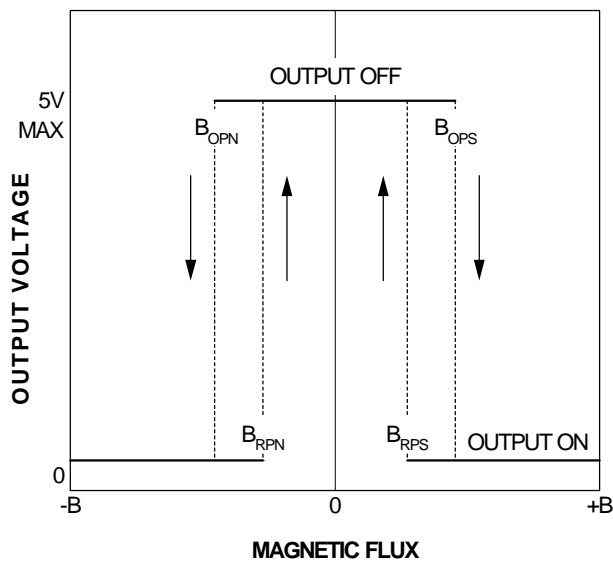

Application Information

It is strongly recommended that an external bypass capacitor can be connected (is close to the Hall sensor) between the supply and the ground of the device to reduce both external noise and noise generated by the chopper-stabilization technique. This is especially true due to the relatively high impedance of battery supplies.

Pole-independent

The pole-independent sensing technique allows for operation with either a north or a south pole magnet orientation, enhancing the manufacturability of the device. The state-of-the-art technology provides the same output polarity for either pole in presence.

Awake & Sleep

Internal awake & sleep timing block circuit activates the sensor for 180 μ s and deactivates it for the remainder of the period (60ms). A short “awake” time allows for stabilization prior to the sensor sampling and data latching on the falling edge of the timing pulse. While in sleep cycle, the output is latched in its previous state.

Chopper Stabilized Technique

The chopper stabilized technique cancels the mismatching of the hall element, the amplifier offset voltage and temperature sensitive drift by the dynamic offset cancellation and switched capacitor technique. This technique produces devices has an extremely stable Hall output voltage, therefore, the magnetic switch points are stable.

Recommended Minimum Footprint

The PCB SMD process maybe cause huger thermal stress on IC chip through exposed pad, so the recommended PCB layout footprint is without exposed pad.

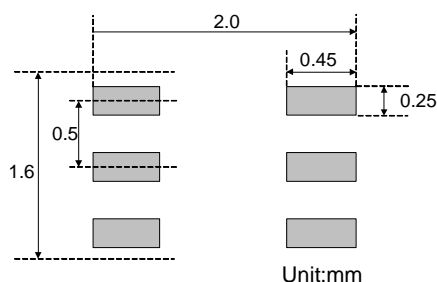

VTDFN1.6x1.6-6

Package Information

VTDFN1.6x1.6-6

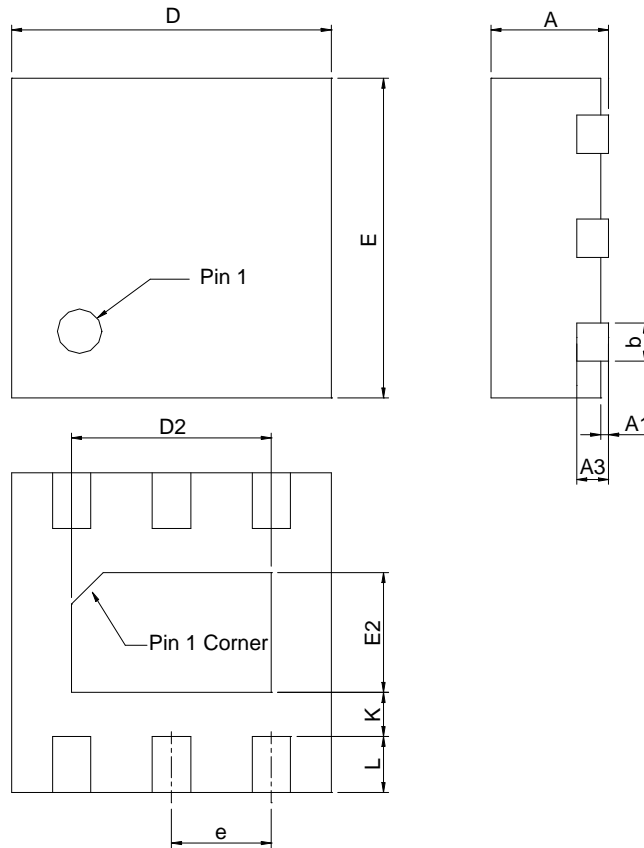

DIMENSIONS	VTDFN1.6x1.6-6			
	MILLIMETERS		INCHES	
	MIN.	MAX.	MIN.	MAX.
A	0.50	0.60	0.020	0.024
A1	0.00	0.05	0.000	0.002
A3	0.15 REF		0.006 REF	
b	0.20	0.30	0.008	0.012
D	1.55	1.65	0.061	0.065
D2	0.95	1.05	0.037	0.041
E	1.55	1.65	0.061	0.065
E2	0.55	0.65	0.022	0.026
e	0.50 BSC		0.020 BSC	
K	0.20		0.008	
L	0.19	0.29	0.007	0.011

Carrier Tape & Reel Dimensions

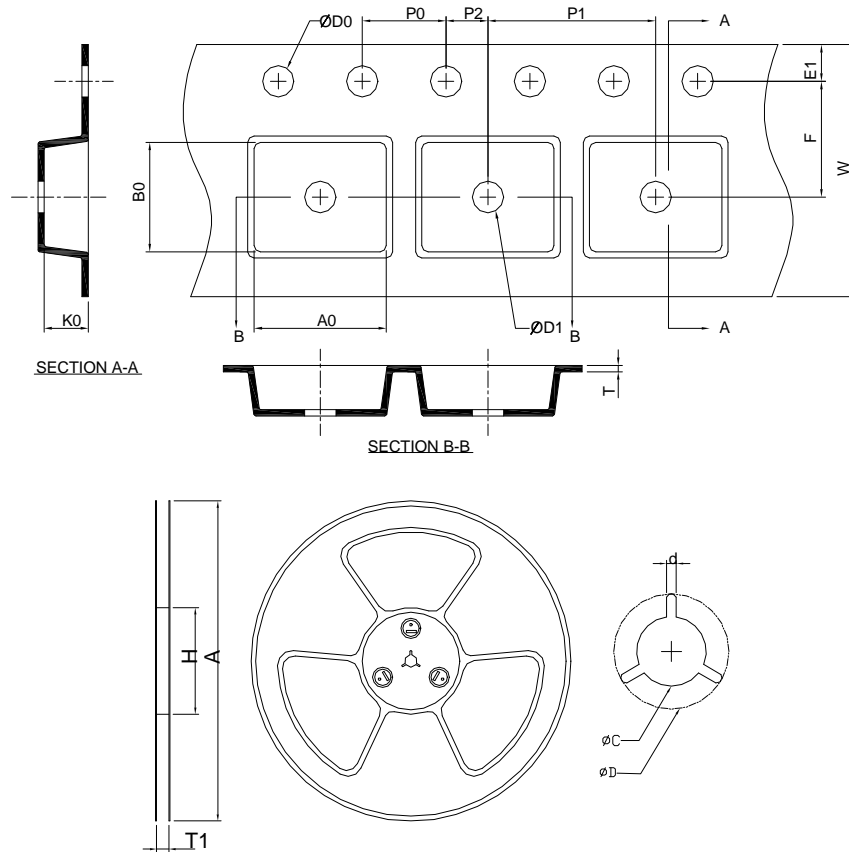

Application	A	H	T1	C	d	D	W	E1	F
VTDFN1.6x1.6-6	178.0 ±0.00	50 MIN.	8.4+2.00 -0.00	13.0+0.50 -0.20	1.5 MIN.	20.2 MIN.	8.0 ±0.20	1.75 ±0.10	3.50 ±0.05
	P0	P1	P2	D0	D1	T	A0	B0	K0
	4.0 ±0.10	4.0 ±0.10	2.0 ±0.05	1.5+0.10 -0.00	1.5 MIN.	0.6+0.00 -0.4	1.4 MIN	1.8 MIN	0.75 ±0.20

(mm)

Devices Per Unit

Package Type	Unit	Quantity
VTDFN1.6x1.6-6	Tape & Reel	3000

Taping Direction Information

VTDFN1.6x1.6-6

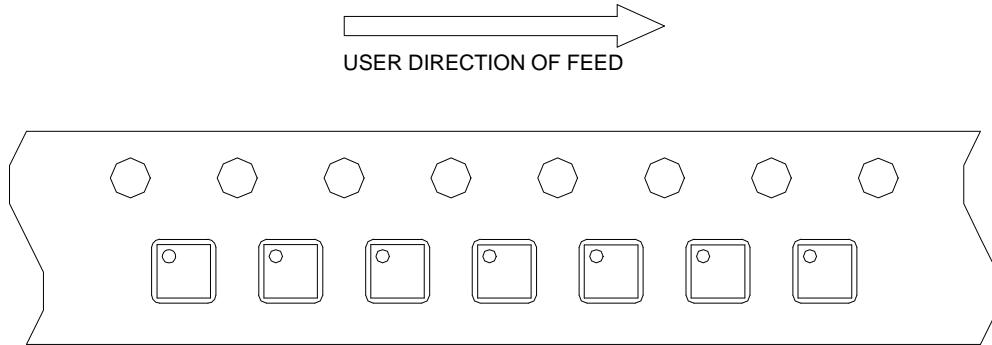

Classification Profile

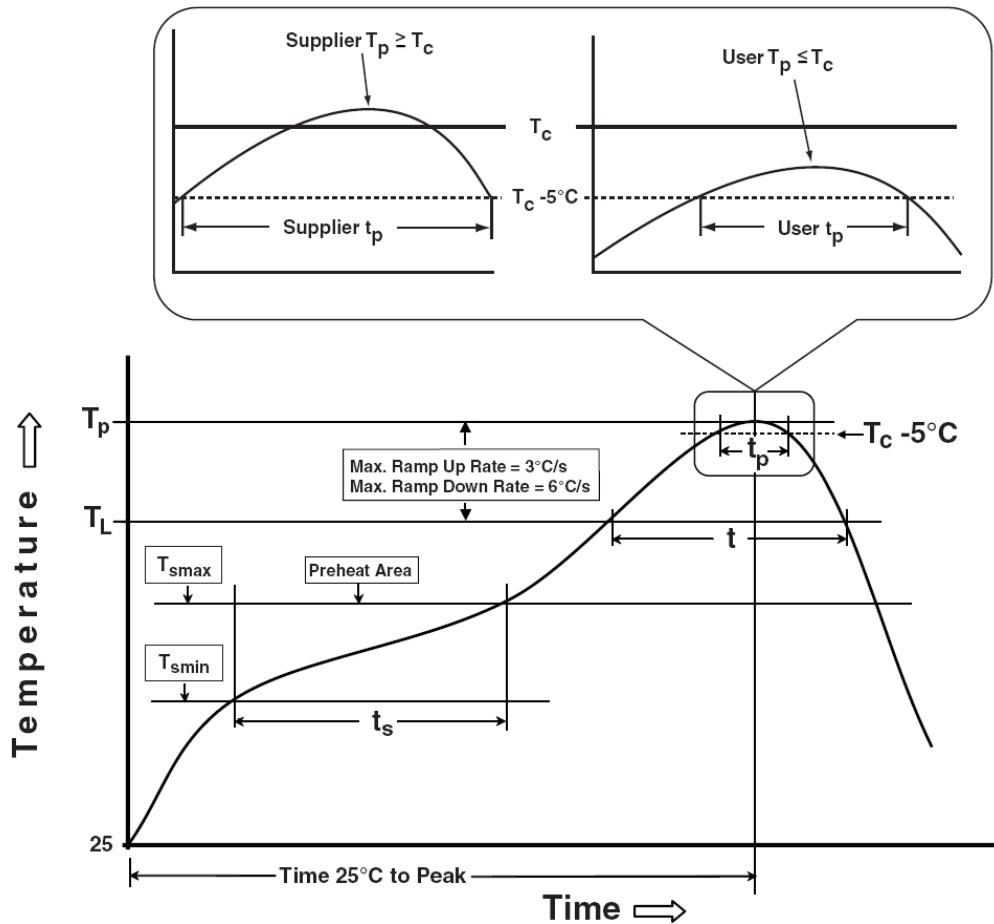

Classification Reflow Profiles

Profile Feature	Sn-Pb Eutectic Assembly	Pb-Free Assembly
Preheat & Soak Temperature min (T_{smin}) Temperature max (T_{smax}) Time (T_{smin} to T_{smax}) (t_s)	100 °C 150 °C 60-120 seconds	150 °C 200 °C 60-120 seconds
Average ramp-up rate (T_{smax} to T_p)	3 °C/second max.	3 °C/second max.
Liquidous temperature (T_L) Time at liquidous (t_L)	183 °C 60-150 seconds	217 °C 60-150 seconds
Peak package body Temperature (T_p)*	See Classification Temp in table 1	See Classification Temp in table 2
Time (t_p)** within 5°C of the specified classification temperature (T_c)	20** seconds	30** seconds
Average ramp-down rate (T_p to T_{smax})	6 °C/second max.	6 °C/second max.
Time 25°C to peak temperature	6 minutes max.	8 minutes max.
* Tolerance for peak profile Temperature (T_p) is defined as a supplier minimum and a user maximum. ** Tolerance for time at peak profile temperature (t_p) is defined as a supplier minimum and a user maximum.		

Table 1. SnPb Eutectic Process – Classification Temperatures (T_c)

Package Thickness	Volume mm ³ <350	Volume mm ³ ≥350
<2.5 mm	235 °C	220 °C
≥2.5 mm	220 °C	220 °C

Table 2. Pb-free Process – Classification Temperatures (T_c)

Package Thickness	Volume mm ³ <350	Volume mm ³ 350-2000	Volume mm ³ >2000
<1.6 mm	260 °C	260 °C	260 °C
1.6 mm – 2.5 mm	260 °C	250 °C	245 °C
≥2.5 mm	250 °C	245 °C	245 °C

Reliability Test Program

Test item	Method	Description
SOLDERABILITY	JESD-22, B102	5 Sec, 245°C
HOLT	JESD-22, A108	1000 Hrs, Bias @ $T_j=125^{\circ}\text{C}$
PCT	JESD-22, A102	168 Hrs, 100%RH, 2atm, 121°C
TCT	JESD-22, A104	500 Cycles, -65°C~150°C
HBM	MIL-STD-883-3015.7	VHBM 2KV
MM	JESD-22, A115	VMM 200V
Latch-Up	JESD 78	10ms, 1 _{tr} 100mA

Customer Service

Anpec Electronics Corp.

Head Office :

No.6, Dusing 1st Road, SBIP,
Hsin-Chu, Taiwan
Tel : 886-3-5642000
Fax : 886-3-5642050

Taipei Branch :

2F, No. 11, Lane 218, Sec 2 Jhongsing Rd.,
Sindian City, Taipei County 23146, Taiwan
Tel : 886-2-2910-3838
Fax : 886-2-2917-3838

X-ON Electronics

Largest Supplier of Electrical and Electronic Components

Click to view similar products for [Industrial Hall Effect/Magnetic Sensors](#) category:

Click to view products by [Anpec](#) manufacturer:

Other Similar products are found below :

[GT-13013](#) [GT-13040](#) [GT-14114](#) [DRR-129\(62-68\)](#) [ATS682LSHTN-T](#) [SR4P2-C7](#) [GT-12076](#) [GT-13012](#) [GT-14049](#) [GT-14067](#) [GT-14132](#)
[GT-18030](#) [103FW12-R3](#) [A1155LLHLT-T](#) [SMSA2P30CG](#) [P2D-000](#) [GN 55.2-SC-15-3](#) [GN 55.2-SC-5-3](#) [MZA70175](#) [103FW41-R1](#) [KJR-](#)
[D100AN-DNA-VE](#) [KJR-D100AN-DNIA-V2](#) [SR-10018](#) [115L 14E 502 W06017](#) [ATS128LSETN-T](#) [TLE4906LHALA1](#) [TLE49452LHALA1](#)
[BU52013HFV-TR](#) [MRMS591A](#) [103SR14A-1](#) [MZT7-03VPS-KR0](#) [MZT7-03VPS-KW0](#) [MZT8-03VPS-KW0](#) [MZT8-28VPS-KP0](#)
[A1326LLHLT-T](#) [A1156LLHLT-T](#) [ACS770LCB-100U-PFF-T](#) [ATS617LSGTN-T](#) [AH49ENTR-G1](#) [SS360PT](#) [SS311PT](#) [GN 55.2-ND-15-3](#)
[GN 55.2-ND-18-3](#) [GN 55.2-ND-8-3](#) [GN 55.2-SC-10-3](#) [GN 55.4-ND-10-7,5-2](#) [GN 55.4-ND-12-9,5-2,5](#) [GN 55.4-ND-26-20,3-5](#) [GN 55.4-ND-](#)
[7,5-4-1,5](#) [101MG7-BP](#)