

REV.	B5	EN1502130004	2015.03.09	郭本恩	GENERAL TOLERANCE	2001.02.01	2001.02.01	APPROVED BY	修正一	UNIT	mm	SCALE	SHEET	1 of 1	TITLE:	燦達電子工業股份有限公司 JOINT TECH ELECTRONIC IND. CO., LTD.
B4	EN1408180001	2014.08.15	黃培華	X.XX±0.25	ANGLE										2.50mm PITCH 180° WAFER	DRAW NO. : A2506WV-XP
B3	EN104060085	2011.04.06	陳錦展	X.XX±0.15												REV.
B2																B5

Circuit	No.	A	B	C
02P	2.50	7.50	6.12	
03P	5.00	10.00	8.62	
04P	7.50	12.50	11.12	
05P	10.00	15.00	13.62	
06P	12.50	17.50	16.12	
07P	15.00	20.00	18.62	
08P	17.50	22.50	21.12	
09P	20.00	25.00	23.62	
10P	22.50	27.50	26.12	
11P	25.00	30.00	28.62	
12P	27.50	32.50	31.12	
13P	30.00	35.00	33.62	
14P	32.50	37.50	36.12	
15P	35.00	40.00	38.62	
16P	37.50	42.50	41.12	

MATED CONDITION

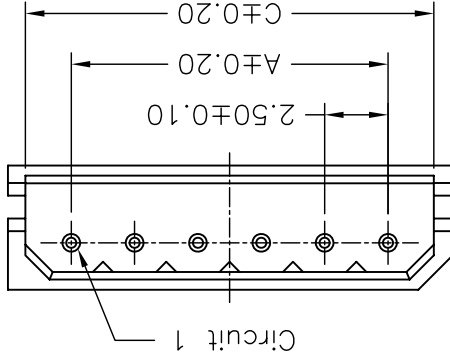
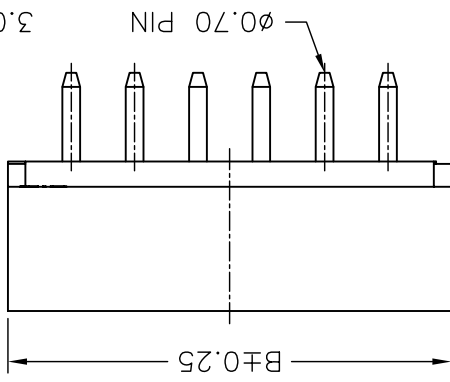
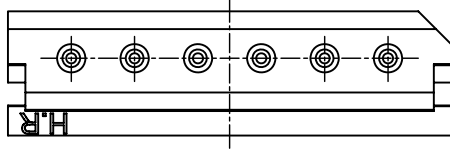
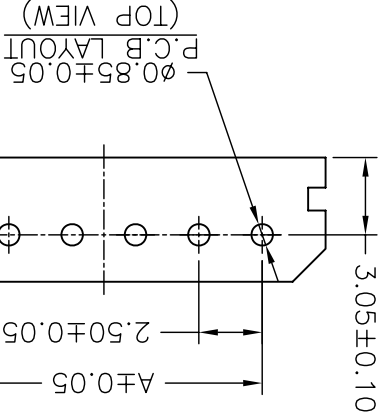
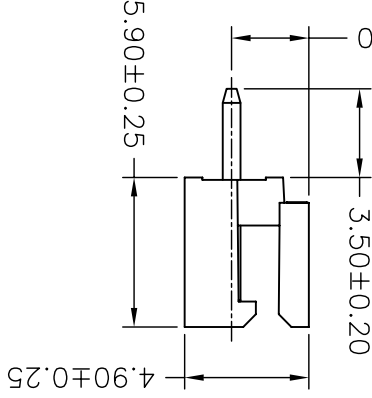
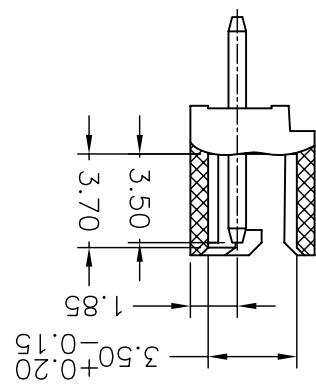
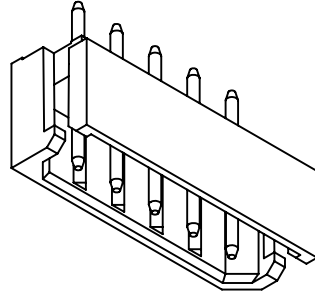
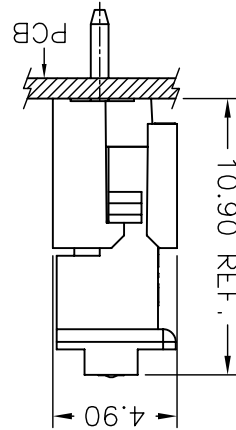

P/N LEGEND
A2506 WV-XP XXX

① Series No.
② Connector type: WV=Vertical
③ No. of circuits
④ Option code:

Blank=Nylon66-V0, Beige(7506C), Tin-plated
BE=Nylon66-V0, Beige(7506C), Tin-plated
BK=Nylon66-V0, Natural(Black), Tin-plated
6TG=Nylon66-V0, Natural(Beige), Gold-flash
NF=Nylon66-V2, NO FLAME, Natural(Beige)
Tin-plated, IEC 60335-1 rev. 4
6T=Nylon6T-V0, Natural(Beige), Tin-plated
6T=Nylon6T-V0, Natural(Beige), Tin-plated

SPECIFICATIONS
Current Rating: 3A AC,DC
Voltage Rating: 250V AC,DC
Temperature Range: -25°C ~ +85°C
Contact Resistance: 20mΩ Max
Insulation Resistance: 1000MΩ Min
Withstanding Voltage: 1000V AC/minute
Pin Material: Brass

X-ON Electronics

Largest Supplier of Electrical and Electronic Components

Click to view similar products for [Headers & Wire Housings](#) category:

Click to view products by [Joint manufacturer](#):

Other Similar products are found below :

[95000-104TRLF](#) [10135584-644402LF](#) [DF62W-EP2022PCA](#) [95000-106TRLF](#) [DF62W-2022SCA](#) [DF62W-EP2022PC](#) [2203348](#) [DF62W-2022SC](#) [1084018](#) [1029039](#) [1084017](#) [802-10-012-10-002000](#) [1112640](#) [1112639](#) [891-007-9SS-BST1T](#) [000-34000](#) [0008550134](#) [0009482033](#) [0009507031](#) [57102-F02-18ULF](#) [57102-S06-03LF](#) [57202-S52-04LF](#) [PCN6-15S-2.5E](#) [0039019024](#) [58102-G61-06LF](#) [582553-1](#) [0009485154](#) [0009508121](#) [0022285053](#) [0050291907](#) [018731A](#) [LY20-4P-DT1-P1E-BR](#) [02.125.8002.8](#) [60101931](#) [60598-1 \(Cut Strip\)](#) [M1625-3R/100](#) [61062-3](#) [61082-181009](#) [CSU011177004](#) [636-1427](#) [638009-1](#) [641938-9](#) [641991-4](#) [644168-1](#) [644827-2](#) [647662-1](#) [65039-019ELF](#) [65692-001LF](#) [65781-018](#) [65781-047](#)