

SPECIFICATION

SPEC. No. A-150°C-c

D A T E : 2016 Oct.

To

Non-Controlled Copy

CUSTOMER'S PRODUCT NAME

TDK'S PRODUCT NAME

Multilayer Ceramic Chip Capacitors
CGA Series/ Automotive grade
High Temperature Application

Please return this specification to TDK representatives with your signature.
If orders are placed without returned specification, please allow us to judge that specification is accepted by your side.

RECEIPT CONFIRMATION

DATE: _____ YEAR _____ MONTH _____ DAY _____

Test conditions in this specification based on AEC-Q200 for automotive application.

TDK Corporation

Sales

Electronic Components

Sales & Marketing Group

Engineering

Electronic Components Business Company

Ceramic Capacitors Business Group

APPROVED	Person in charge

APPROVED	CHECKED	Person in charge

1. SCOPE

This specification is applicable to chip type multilayer ceramic capacitors with a priority over the other relevant specifications.

Production places defined in this specification shall be TDK Corporation Japan, TDK(Suzhou)Co.,Ltd and TDK Components U.S.A. Inc.

EXPLANATORY NOTE:

This specification warrant the quality of the ceramic chip capacitor. The chips should be evaluated or confirmed a state of mounted on your product.

If the use of the chips go beyond the bounds of this specification, we can not afford to guarantee.

2. CODE CONSTRUCTION

(Example)

Catalog Number (Web)	<u>CGA</u> (1)	<u>2</u> (2)	<u>B</u> (3)	<u>2</u> (4)	<u>X8R</u> (5)	<u>1 E</u> (6)	<u>103</u> (7)	<u>K</u> (8)	<u>050</u> (9)	<u>B</u> (10)	<u>A</u> (11)
Item Description	<u>CGA</u> (1)	<u>2</u> (2)	<u>B</u> (3)	<u>2</u> (4)	<u>X8R</u> (5)	<u>1 E</u> (6)	<u>103</u> (7)	<u>K</u> (8)	<u>T</u> (12)	<u>OOOO</u> (13)	

(1) Series

Symbol	Series
CGA	For automotive application

(2) Case size symbol

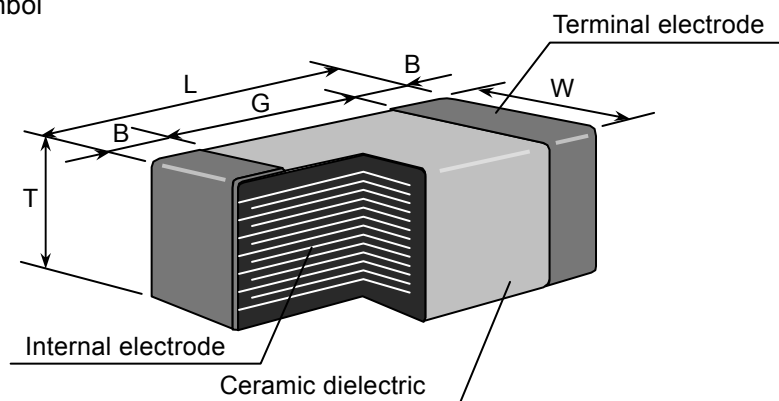

Symbol	Type (EIA style)
2	CC0402
3	CC0603
4	CC0805
5	CC1206

Symbol	Type (EIA style)
6	CC1210
8	CC1812
9	CC2220

*As for dimensions of each product, please refer to detailed information on TDK web.

(3) Thickness

Symbol	Dimension(mm)	Symbol	Dimension(mm)
B	0.50	L	1.60
C	0.60	M	2.00
E	0.80	N	2.30
F	0.85	P	2.50
H	1.15	Q	2.80
J	1.25	R	3.20

(4) Voltage condition in the life test
(Details are shown in table 1 No.16 at 8.PERFORMANCE.)

Symbol	Condition
1	Rated Voltage
2	Rated Voltage x 2
3	Rated Voltage x 1.5
4	Rated Voltage x 1.2

(5) Temperature Characteristics
(Details are shown in table 1 No.6 and No.7 at 8.PERFORMANCE.)

(6) Rated Voltage

Symbol	Rated Voltage	Symbol	Rated Voltage
2 J	DC 630 V	1 H	DC 50 V
2 W	DC 450 V	1 E	DC 25 V
2 E	DC 250 V	1 C	DC 16 V
2 A	DC 100 V		

(7) Rated Capacitance

Stated in three digits and in units of pico farads (pF).
The first and Second digits identify the first and second significant figures of the capacitance, the third digit identifies the multiplier.
R is designated for a decimal point.

Symbol	Rated Capacitance
2R2	2.2pF
105	1,000,000pF (=1μF)

(8) Capacitance tolerance

Symbol	Tolerance	Capacitance
C	± 0.25 pF	10pF and under
D	± 0.5 pF	
J	± 5 %	Over 10pF
K	± 10 %	
M	± 20 %	

(9) Thickness code (Only catalog number)

(10) Package code (Only catalog number)

(11) Special code (Only catalog number)

(12) Packaging (Only item description)
(Bulk is not applicable for CGA2(CC0402) type.)

Symbol	Packaging
B	Bulk
T	Taping

(13) TDK internal code (Only item description)

3. RATED CAPACITANCE AND TOLERANCE

3.1 Standard combination of rated capacitance and tolerances

Class	Temperature Characteristics	Capacitance tolerance		Rated capacitance
1	NP0	10pF and under	C ($\pm 0.25\text{pF}$)	1, 1.5, 2, 2.2, 3, 3.3, 4, 4.7, 5
			D ($\pm 0.5\text{pF}$)	6, 6.8, 7, 8, 9, 10
		12pF to 10,000pF	J ($\pm 5\%$)	E – 12 series
		Over 10,000pF		E – 6 series
2	X8R	K ($\pm 10\%$) M ($\pm 20\%$)		E – 6 series

3.2 Capacitance Step in E series

E series	Capacitance Step											
E-6	1.0		1.5		2.2		3.3		4.7		6.8	
E-12	1.0	1.2	1.5	1.8	2.2	2.7	3.3	3.9	4.7	5.6	6.8	8.2

4. OPERATING TEMPERATURE RANGE

T.C.	Min. operating Temperature	Max. operating Temperature	Reference Temperature
NP0,X8R	-55°C	150°C	25°C

5. STORING CONDITION AND TERM

5 to 40°C at 20 to 70%RH

6 months Max.

6. P.C. BOARD

When mounting on an aluminum substrate, large case size such as CGA6(CC1210), CGA8(CC1812) and CGA9(CC2220) types are more likely to be affected by heat stress from the substrate.

Please inquire separate specification for the large case sizes when mounted on the substrate.

7. INDUSTRIAL WASTE DISPOSAL

Dispose this product as industrial waste in accordance with the Industrial Waste Law.

8. PERFORMANCE

table 1

No.	Item	Performance	Test or inspection method																	
1	External Appearance	No defects which may affect performance.	Inspect with magnifying glass (3×)																	
2	Insulation Resistance	10,000MΩ or 500MΩ·μF min. (As for the capacitors of rated voltage 16V DC and, 10,000 MΩ or 100MΩ·μF min.,) whichever smaller.	Apply rated voltage for 60s. As for the capacitor of rated voltage 630V DC, apply 500V DC.																	
3	Voltage Proof	Withstand test voltage without insulation breakdown or other damage.	<table border="1"> <thead> <tr> <th>T.C.</th> <th>Rated voltage(RV)</th> <th>Apply voltage</th> </tr> </thead> <tbody> <tr> <td rowspan="3">NP0</td> <td>$RV \leq 100V$</td> <td>3 × rated voltage</td> </tr> <tr> <td>$100V < RV \leq 500V$</td> <td>1.5 × rated voltage</td> </tr> <tr> <td>$500V < RV$</td> <td>1.3 × rated voltage</td> </tr> <tr> <td rowspan="3">X8R</td> <td>$RV \leq 100V$</td> <td>2.5 × rated voltage</td> </tr> <tr> <td>$100V < RV \leq 500V$</td> <td>1.5 × rated voltage</td> </tr> <tr> <td>$500V < RV$</td> <td>1.3 × rated voltage</td> </tr> </tbody> </table> <p>Above DC voltage shall be applied for 1s. Charge / discharge current shall not exceed 50mA.</p>	T.C.	Rated voltage(RV)	Apply voltage	NP0	$RV \leq 100V$	3 × rated voltage	$100V < RV \leq 500V$	1.5 × rated voltage	$500V < RV$	1.3 × rated voltage	X8R	$RV \leq 100V$	2.5 × rated voltage	$100V < RV \leq 500V$	1.5 × rated voltage	$500V < RV$	1.3 × rated voltage
T.C.	Rated voltage(RV)	Apply voltage																		
NP0	$RV \leq 100V$	3 × rated voltage																		
	$100V < RV \leq 500V$	1.5 × rated voltage																		
	$500V < RV$	1.3 × rated voltage																		
X8R	$RV \leq 100V$	2.5 × rated voltage																		
	$100V < RV \leq 500V$	1.5 × rated voltage																		
	$500V < RV$	1.3 × rated voltage																		
4	Capacitance	Within the specified tolerance.	<table border="1"> <thead> <tr> <th>T.C.</th> <th>Capacitance</th> <th>Measuring frequency</th> <th>Measuring voltage</th> </tr> </thead> <tbody> <tr> <td rowspan="2">NP0</td> <td>1000pF and under</td> <td>1MHz±10%</td> <td rowspan="2">0.5-5Vrms.</td> </tr> <tr> <td>Over 1000pF</td> <td>1kHz±10%</td> </tr> <tr> <td>X8R</td> <td>All</td> <td>1kHz±10%</td> <td>1.0±0.2Vrms</td> </tr> </tbody> </table> <p>For information which product has which measuring voltage, please contact with our sales representative.</p>	T.C.	Capacitance	Measuring frequency	Measuring voltage	NP0	1000pF and under	1MHz±10%	0.5-5Vrms.	Over 1000pF	1kHz±10%	X8R	All	1kHz±10%	1.0±0.2Vrms			
T.C.	Capacitance	Measuring frequency	Measuring voltage																	
NP0	1000pF and under	1MHz±10%	0.5-5Vrms.																	
	Over 1000pF	1kHz±10%																		
X8R	All	1kHz±10%	1.0±0.2Vrms																	
5	Q (NP0) Dissipation Factor (X8R)	As for spec of each product, please refer to detailed information on TDK web.	See No.4 in this table for measuring condition.																	
6	Temperature Characteristics of Capacitance (NP0)	<hr/> <p style="text-align: center;">Temperature Coefficient</p> <hr/> <p style="text-align: center;">0 ± 30 (ppm/°C)</p> <hr/> <p>Capacitance drift within $\pm 0.2\%$ or $\pm 0.05pF$, whichever larger.</p>	<p>Temperature coefficient shall be calculated based on values at 25°C and 85°C temperature.</p> <p>Measuring temperature below 20°C shall be -10°C and -25°C.</p>																	

(continued)

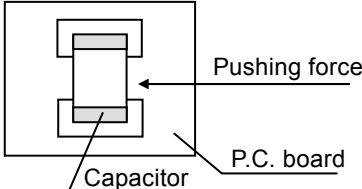
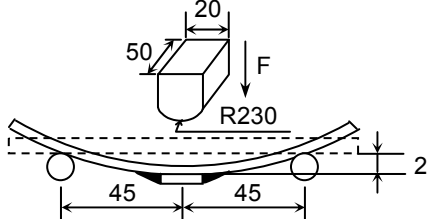
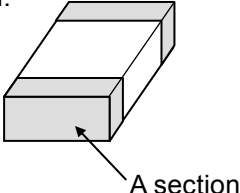
No.	Item	Performance	Test or inspection method										
7	Temperature Characteristics of Capacitance (X8R)	<p style="text-align: center;">Capacitance Change</p> <hr/> <p style="text-align: center;">No voltage applied</p> <hr/> <p style="text-align: center;">$\pm 15(\%)$</p> <hr/>	<p>Capacitance shall be measured by the steps shown in the following table after thermal equilibrium is obtained for each step. ΔC be calculated ref. STEP3 reading</p> <table border="1" data-bbox="976 385 1442 656"> <thead> <tr> <th>Step</th> <th>Temperature(°C)</th> </tr> </thead> <tbody> <tr> <td>1</td> <td>25 ± 2</td> </tr> <tr> <td>2</td> <td>-55 ± 2</td> </tr> <tr> <td>3</td> <td>25 ± 2</td> </tr> <tr> <td>4</td> <td>150 ± 2</td> </tr> </tbody> </table>	Step	Temperature(°C)	1	25 ± 2	2	-55 ± 2	3	25 ± 2	4	150 ± 2
Step	Temperature(°C)												
1	25 ± 2												
2	-55 ± 2												
3	25 ± 2												
4	150 ± 2												
8	Robustness of Terminations	No sign of termination coming off, breakage of ceramic, or other abnormal signs.	<p>Reflow solder the capacitors on a P.C. board shown in Appendix2 and apply a pushing force of 17.7N with 10±1s. (2N is applied for CGA2(CC0402) type)</p> 										
9	Bending	No mechanical damage.	<p>Reflow solder the capacitors on a P.C. board shown in Appendix1 and bend it for 2mm. (1mm is applied for 0.85mm thickness of X8R items.)</p>  <p style="text-align: right;">(Unit : mm)</p>										
10	Solderability	<p>New solder to cover over 75% of termination. 25% may have pin holes or rough spots but not concentrated in one spot. Ceramic surface of A sections shall not be exposed due to melting or shifting of termination material.</p> 	<p>Completely soak both terminations in solder at the following conditions.</p> <p>Solder : Sn-3.0Ag-0.5Cu or Sn-37Pb Temperature : 245±5°C(Sn-3.0Ag-0.5Cu) 235±5°C(Sn-37Pb) Soaking time : 3±0.3s(Sn-3.0Ag-0.5Cu) 2±0.2s(Sn-37Pb)</p> <p>Flux: Isopropyl alcohol (JIS K 8839) Rosin (JIS K 5902) 25% solid solution.</p>										

(continued)

No.	Item		Performance	Test or inspection method	
11	Resistance to solder heat	External appearance	No cracks are allowed and terminations shall be covered at least 60% with new solder.	<p>Completely soak both terminations in solder at the following conditions. 260±5°C for 10±1s.</p> <p>Preheating condition Temp.: 110 ~ 140°C Time : 30 ~ 60s.</p> <p>Solder : Sn-3.0Ag-0.5Cu or Sn-37Pb</p> <p>Flux : Isopropyl alcohol (JIS K 8839) Rosin (JIS K 5902) 25% solid solution.</p> <p>Leave the capacitors in ambient condition for 6 to 24h (NP0) or 24±2h (X8R) before measurement.</p>	
		Capacitance	Characteristics		Change from the value before test
			NP0		± 2.5% or ± 0.25pF, whichever larger.
			X8R		± 7.5 %
		Q (NP0)	Meet the initial spec.		
D.F. (X8R)	Meet the initial spec.				
Insulation Resistance	Meet the initial spec.				
Voltage proof	No insulation breakdown or other damage.				
12	Vibration	External appearance	No mechanical damage.	<p>Reflow solder the capacitors on a P.C. board shown in Appendix2 before testing.</p> <p>Vibrate the capacitors with following conditions. Applied force : 5G max. Frequency : 10-2,000Hz Duration : 20 min. Cycle : 12 cycles in each 3 mutually perpendicular directions.</p>	
		Capacitance	Characteristics		Change from the value before test
			NP0		± 2.5% or ± 0.25pF, whichever larger.
			X8R		± 7.5 %
Q (NP0)	Meet the initial spec.				
D.F. (X8R)	Meet the initial spec.				

(continued)

No.	Item		Performance	Test or inspection method																
13	Temperature cycle	External appearance	No mechanical damage.	Reflow solder the capacitors on a P.C. board shown in Appendix2 before testing. Expose the capacitors in the condition step1 through step 4 and repeat 1,000 times consecutively. Leave the capacitors in ambient condition for 6 to 24h (NP0) or 24±2h (X8R) before measurement.																
		Capacitance	Characteristics		Change from the value before test															
			NP0		± 2.5% or ± 0.25pF, whichever larger.															
			X8R		± 7.5 %															
		Q (NP0)	Meet the initial spec.		<table border="1"> <thead> <tr> <th>Step</th> <th>Temperature(°C)</th> <th>Time (min.)</th> </tr> </thead> <tbody> <tr> <td>1</td> <td>-55 ±3</td> <td>30 ± 3</td> </tr> <tr> <td>2</td> <td>25</td> <td>2 - 5</td> </tr> <tr> <td>3</td> <td>150 ±2</td> <td>30 ± 2</td> </tr> <tr> <td>4</td> <td>25</td> <td>2 - 5</td> </tr> </tbody> </table>	Step	Temperature(°C)	Time (min.)	1	-55 ±3	30 ± 3	2	25	2 - 5	3	150 ±2	30 ± 2	4	25	2 - 5
		Step	Temperature(°C)		Time (min.)															
1	-55 ±3	30 ± 3																		
2	25	2 - 5																		
3	150 ±2	30 ± 2																		
4	25	2 - 5																		
D.F. (X8R)	Meet the initial spec.																			
Insulation Resistance	Meet the initial spec.																			
Voltage proof	No insulation breakdown or other damage.																			
14	Moisture Resistance (Steady State)	External appearance	No mechanical damage.	Reflow solder the capacitors on a P.C. board shown in Appendix2 before testing. Leave at temperature 40±2°C, 90 to 95%RH for 500 +24,0h. Leave the capacitors in ambient condition for 6 to 24h (NP0) or 24±2h (X8R) before measurement.																
		Capacitance	Characteristics		Change from the value before test															
			NP0		± 5% or ± 0.5pF, whichever larger.															
			X8R		± 12.5 %															
		Q (NP0)	Capacitance		Q															
30pF and over	350 min.																			
10pF and over under 30pF	275+5/2×C min.																			
Under 10pF	200+10×C min.																			
C : Rated capacitance (pF)																				
D.F. (X8R)	200% of initial spec. max.																			
Insulation Resistance	1,000MΩ or 50MΩ·μF min. (As for the capacitors of rated voltage 16V DC, 1,000 MΩ or 10MΩ·μF min.,) whichever smaller.																			

(continued)

No.	Item		Performance		Test or inspection method	
15	Moisture Resistance	External appearance	No mechanical damage.		Reflow solder the capacitors on a P.C. board shown in Appendix2 before testing.	
		Capacitance	Characteristics	Change from the value before test		Apply the rated voltage at temperature 85°C and 85%RH for 1,000 +48,0h.
			NP0	±7.5% or ±0.75pF, whichever larger.		Charge/discharge current shall not exceed 50mA.
			X8R	± 12.5 %		Leave the capacitors in ambient condition for 6 to 24h (NP0) or 24±2h (X8R) before measurement.
		Q (NP0)	Capacitance	Q		Voltage conditioning (only for X8R)
30pF and over	200 and over		Voltage treat the capacitors under testing temperature and voltage for 1 hour.			
Under 30pF	100+10/3×C min.		Leave the capacitors in ambient condition for 24±2h before measurement.			
C : Rated capacitance (pF)		200% of initial spec. max.		Use this measurement for initial value.		
D.F. (X8R)	500MΩ or 25MΩ·μF min. (As for the capacitors of rated voltage 16V DC, 500 MΩ or 5MΩ·μF min.,) whichever smaller.					
16	Life	External appearance	No mechanical damage.		Reflow solder the capacitors on a P.C. board shown in Appendix2 before testing.	
		Capacitance	Characteristics	Change from the value before test		Below the voltage shall be applied at 150 ±2°C for 1,000 +48,0h.
			NP0	± 3% or ± 0.3pF, whichever larger.		Applied Voltage
			X8R	± 15 %		Rated voltage x2
		Q (NP0)	Capacitance	Q		Rated voltage x1.5
30pF and over	350 and over		Rated voltage x1.2			
10pF and over to under 30pF	275+5/2×C min.		Rated voltage x1			
C : Rated capacitance (pF)		200+10×C min.		As for applied voltage, please contact with our sales representative.		
D.F. (X8R)	200% of initial spec. max.		Charge/discharge current shall not exceed 50mA.			
Insulation Resistance	1,000MΩ or 50MΩ·μF min. (As for the capacitors of rated voltage 16V DC, 1,000 MΩ or 10MΩ·μF min.,) whichever smaller.		Leave the capacitors in ambient condition for 6 to 24h (NP0) or 24±2h (X8R) before measurement. Voltage conditioning (only for X8R) Voltage treat the capacitors under testing temperature and voltage for 1 hour. Leave the capacitors in ambient condition for 24±2h before measurement. Use this measurement for initial value.			

*As for the initial measurement of capacitors (X8R) on number 7,11,12,13 and 14 leave capacitors at 150 –10,0°C for 1 hour and measure the value after leaving capacitors for 24±2h in ambient condition.

Appendix1 P.C. board for bending test

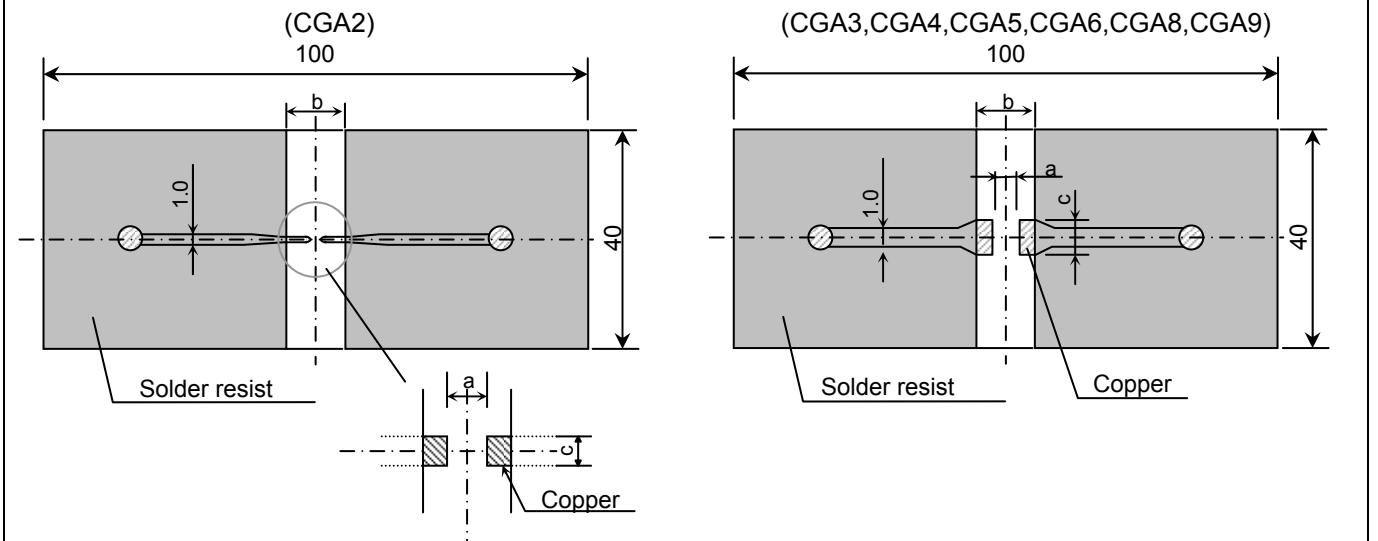

Appendix2 P.C. Board for reliability test

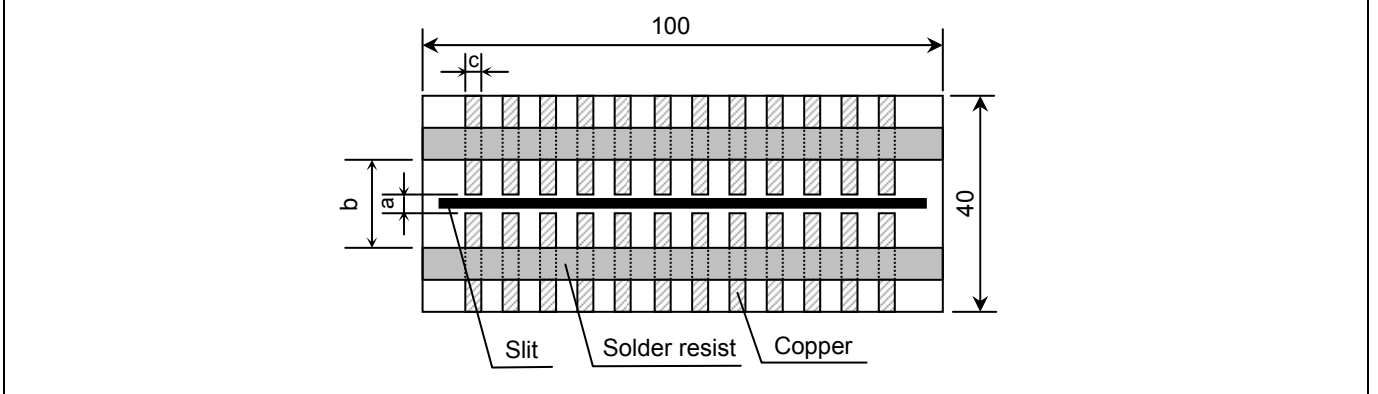

(It is recommended to provide a slit on P.C. board for CGA6,CGA8 and CGA9.)

(Unit : mm)

Type	Dimensions		
	a	b	c
TDK(EIA style)			
CGA2 (CC0402)	0.4	1.5	0.5
CGA3 (CC0603)	1.0	3.0	1.2
CGA4 (CC0805)	1.2	4.0	1.65
CGA5 (CC1206)	2.2	5.0	2.0
CGA6 (CC1210)	2.2	5.0	2.9
CGA8 (CC1812)	3.5	7.0	3.7
CGA9 (CC2220)	4.5	8.0	5.6

1. Material : Glass Epoxy(As per JIS C6484 GE4)

Copper(Thickness:0.035mm)

Solder resist

2. Thickness : Appendix 1 — 0.8mm (CGA2)

— 1.6mm (CGA3,CGA4,CGA5,CGA6,CGA8,CGA9)

: Appendix 2 — 1.6mm

9. INSIDE STRUCTURE AND MATERIAL

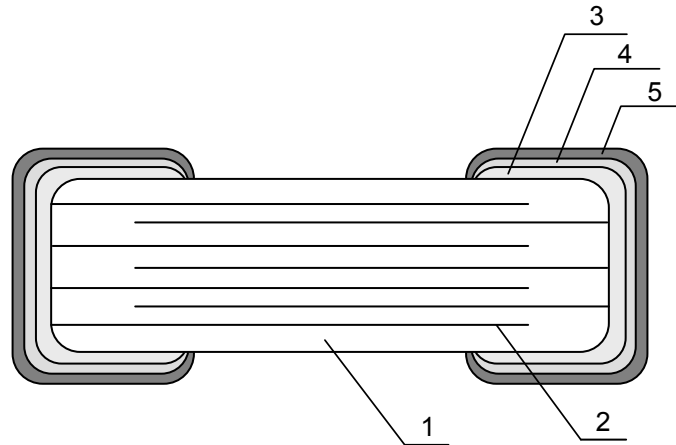

No.	NAME	MATERIAL	
		NP0	X8R
1	Dielectric	CaZrO ₃	BaTiO ₃
2	Electrode	Nickel (Ni)	
3	Termination	Copper (Cu)	
4		Nickel (Ni)	
5		Tin (Sn)	

10. PACKAGING

Packaging shall be done to protect the components from the damage during transportation and storing, and a label which has the following information shall be attached.

- 1) Total number of components in a plastic bag for bulk packaging : 1000pcs
- 2) Tape packaging is as per 14. TAPE PACKAGING SPECIFICATION.
(CGA2 [CC0402] types are applicable only to tape packaging.)

- 1) Inspection No.
- 2) TDK P/N
- 3) Customer's P/N
- 4) Quantity

*Composition of Inspection No.

Example F 6 A - 00 - 000
 (a) (b) (c) (d) (e)

- a) Line code
- b) Last digit of the year
- c) Month and A for January and B for February and so on. (Skip I)
- d) Inspection Date of the month.
- e) Serial No. of the day

11. RECOMMENDATION

As for CGA6 [CC1210] and larger, It is recommended to provide a slit (about 1mm width) in the board under the components to improve washing Flux. And please make sure to dry detergent up completely before.

12. SOLDERING CONDITION

As for CGA2 [CC0402], CGA6 [CC1210] and larger, reflow soldering only.

13. Caution

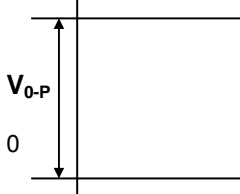
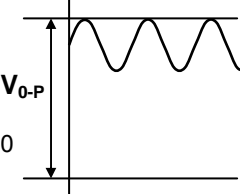
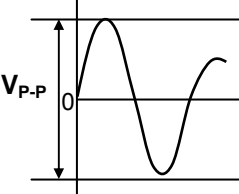
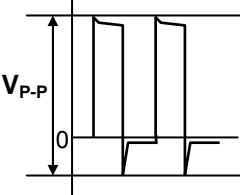
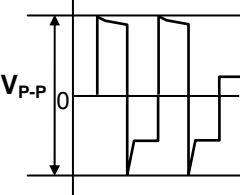
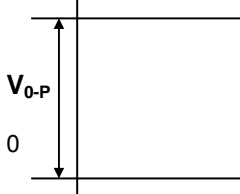
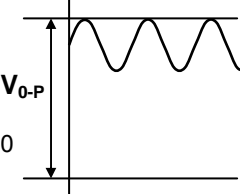
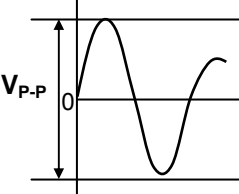
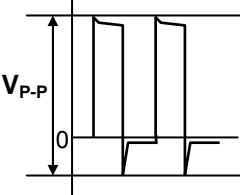
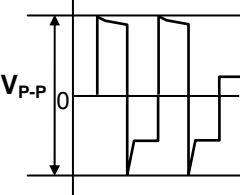
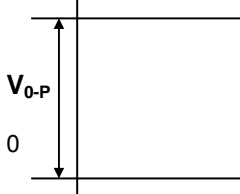
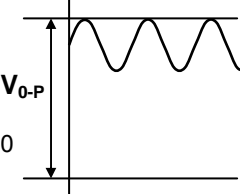
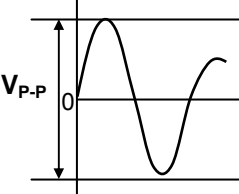
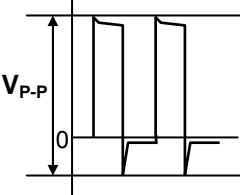
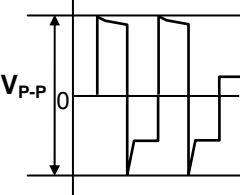
No.	Process	Condition														
1	Operating Condition (Storage, Transportation)	<p>1-1. Storage</p> <ol style="list-style-type: none"> 1) The capacitors must be stored in an ambient temperature of 5 to 40°C with a relative humidity of 20 to 70%RH. The products should be used within 6 months upon receipt. 2) The capacitors must be operated and stored in an environment free of dew condensation and these gases such as Hydrogen Sulphide, Hydrogen Sulphate, Chlorine, Ammonia and sulfur. 3) Avoid storing in sun light and falling of dew. 4) Do not use capacitors under high humidity and high and low atmospheric pressure which may affect capacitors reliability. 5) Capacitors should be tested for the solderability when they are stored for long time. <p>1-2. Handling in transportation In case of the transportation of the capacitors, the performance of the capacitors may be deteriorated depending on the transportation condition. (Refer to JEITA RCR-2335C 9.2 Handling in transportation)</p>														
2	Circuit design ⚠ Caution	<p>2-1. Operating temperature Operating temperature should be followed strictly within this specification, especially be careful with maximum temperature.</p> <ol style="list-style-type: none"> 1) Do not use capacitors above the maximum allowable operating temperature. 2) Surface temperature including self heating should be below maximum operating temperature. (Due to dielectric loss, capacitors will heat itself when AC is applied. Especially at high frequencies around its SRF, the heat might be so extreme that it may damage itself or the product mounted on. Please design the circuit so that the maximum temperature of the capacitors including the self heating to be below the maximum allowable operating temperature. Temperature rise at capacitor surface shall be below 20°C) 3) The electrical characteristics of the capacitors will vary depending on the temperature. The capacitors should be selected and designed in taking the temperature into consideration. <p>2-2. Operating voltage</p> <ol style="list-style-type: none"> 1) Operating voltage across the terminals should be below the rated voltage. When AC and DC are super imposed, V_{0-P} must be below the rated voltage. — (1) and (2) <p>AC or pulse with overshooting, V_{P-P} must be below the rated voltage. — (3), (4) and (5)</p> <p>When the voltage is started to apply to the circuit or it is stopped applying, the irregular voltage may be generated for a transit period because of resonance or switching. Be sure to use the capacitors within rated voltage containing these Irregular voltage.</p> <table border="1" data-bbox="475 1480 1445 2051"> <thead> <tr> <th data-bbox="475 1480 660 1525">Voltage</th> <th data-bbox="660 1480 922 1525">(1) DC voltage</th> <th data-bbox="922 1480 1184 1525">(2) DC+AC voltage</th> <th data-bbox="1184 1480 1445 1525">(3) AC voltage</th> </tr> </thead> <tbody> <tr> <td data-bbox="475 1525 660 1749"> Positional Measurement (Rated voltage) </td> <td data-bbox="660 1525 922 1749">  </td> <td data-bbox="922 1525 1184 1749">  </td> <td data-bbox="1184 1525 1445 1749">  </td> </tr> <tr> <th data-bbox="475 1783 660 1827">Voltage</th> <th data-bbox="660 1783 922 1827">(4) Pulse voltage (A)</th> <th data-bbox="922 1783 1184 1827">(5) Pulse voltage (B)</th> </tr> <tr> <td data-bbox="475 1827 660 2051"> Positional Measurement (Rated voltage) </td> <td data-bbox="660 1827 922 2051">  </td> <td data-bbox="922 1827 1184 2051">  </td> </tr> </tbody> </table>	Voltage	(1) DC voltage	(2) DC+AC voltage	(3) AC voltage	Positional Measurement (Rated voltage)				Voltage	(4) Pulse voltage (A)	(5) Pulse voltage (B)	Positional Measurement (Rated voltage)		
Voltage	(1) DC voltage	(2) DC+AC voltage	(3) AC voltage													
Positional Measurement (Rated voltage)																
Voltage	(4) Pulse voltage (A)	(5) Pulse voltage (B)														
Positional Measurement (Rated voltage)																

No.	Process	Condition																																																				
2	Circuit design ⚠ Caution	<p>2) Even below the rated voltage, if repetitive high frequency AC or pulse is applied, the reliability of the capacitors may be reduced.</p> <p>3) The effective capacitance will vary depending on applied DC and AC voltages. The capacitors should be selected and designed in taking the voltages into consideration.</p> <p>2-3. Frequency When the capacitors (Class 2) are used in AC and/or pulse voltages, the capacitors may vibrate themselves and generate audible sound.</p>																																																				
3	Designing P.C. board	<p>The amount of solder at the terminations has a direct effect on the reliability of the capacitors.</p> <p>1) The greater the amount of solder, the higher the stress on the chip capacitors, and the more likely that it will break. When designing a P.C. board, determine the shape and size of the solder lands to have proper amount of solder on the terminations.</p> <p>2) Avoid using common solder land for multiple terminations and provide individual solder land for each terminations.</p> <p>3) Size and recommended land dimensions.</p> <div style="text-align: center;"> </div> <table border="1" style="width: 100%; text-align: center;"> <caption>Flow soldering (mm)</caption> <thead> <tr> <th>Type</th> <th>CGA3 (CC0603)</th> <th>CGA4 (CC0805)</th> <th>CGA5 (CC1206)</th> </tr> </thead> <tbody> <tr> <td>A</td> <td>0.7 - 1.0</td> <td>1.0 - 1.3</td> <td>2.1 - 2.5</td> </tr> <tr> <td>B</td> <td>0.8 - 1.0</td> <td>1.0 - 1.2</td> <td>1.1 - 1.3</td> </tr> <tr> <td>C</td> <td>0.6 - 0.8</td> <td>0.8 - 1.1</td> <td>1.0 - 1.3</td> </tr> </tbody> </table> <table border="1" style="width: 100%; text-align: center;"> <caption>Reflow soldering (mm)</caption> <thead> <tr> <th>Type</th> <th>CGA2 (CC0402)</th> <th>CGA3 (CC0603)</th> <th>CGA4 (CC0805)</th> </tr> </thead> <tbody> <tr> <td>A</td> <td>0.3 - 0.5</td> <td>0.6 - 0.8</td> <td>0.9 - 1.2</td> </tr> <tr> <td>B</td> <td>0.35 - 0.45</td> <td>0.6 - 0.8</td> <td>0.7 - 0.9</td> </tr> <tr> <td>C</td> <td>0.4 - 0.6</td> <td>0.6 - 0.8</td> <td>0.9 - 1.2</td> </tr> </tbody> </table> <table border="1" style="width: 100%; text-align: center;"> <thead> <tr> <th>Type</th> <th>CGA5 (CC1206)</th> <th>CGA6 (CC1210)</th> <th>CGA8 (CC1812)</th> <th>CGA9 (CC2220)</th> </tr> </thead> <tbody> <tr> <td>A</td> <td>2.0 - 2.4</td> <td>2.0 - 2.4</td> <td>3.1 - 3.7</td> <td>4.1 - 4.8</td> </tr> <tr> <td>B</td> <td>1.0 - 1.2</td> <td>1.0 - 1.2</td> <td>1.2 - 1.4</td> <td>1.2 - 1.4</td> </tr> <tr> <td>C</td> <td>1.1 - 1.6</td> <td>1.9 - 2.5</td> <td>2.4 - 3.2</td> <td>4.0 - 5.0</td> </tr> </tbody> </table>	Type	CGA3 (CC0603)	CGA4 (CC0805)	CGA5 (CC1206)	A	0.7 - 1.0	1.0 - 1.3	2.1 - 2.5	B	0.8 - 1.0	1.0 - 1.2	1.1 - 1.3	C	0.6 - 0.8	0.8 - 1.1	1.0 - 1.3	Type	CGA2 (CC0402)	CGA3 (CC0603)	CGA4 (CC0805)	A	0.3 - 0.5	0.6 - 0.8	0.9 - 1.2	B	0.35 - 0.45	0.6 - 0.8	0.7 - 0.9	C	0.4 - 0.6	0.6 - 0.8	0.9 - 1.2	Type	CGA5 (CC1206)	CGA6 (CC1210)	CGA8 (CC1812)	CGA9 (CC2220)	A	2.0 - 2.4	2.0 - 2.4	3.1 - 3.7	4.1 - 4.8	B	1.0 - 1.2	1.0 - 1.2	1.2 - 1.4	1.2 - 1.4	C	1.1 - 1.6	1.9 - 2.5	2.4 - 3.2	4.0 - 5.0
Type	CGA3 (CC0603)	CGA4 (CC0805)	CGA5 (CC1206)																																																			
A	0.7 - 1.0	1.0 - 1.3	2.1 - 2.5																																																			
B	0.8 - 1.0	1.0 - 1.2	1.1 - 1.3																																																			
C	0.6 - 0.8	0.8 - 1.1	1.0 - 1.3																																																			
Type	CGA2 (CC0402)	CGA3 (CC0603)	CGA4 (CC0805)																																																			
A	0.3 - 0.5	0.6 - 0.8	0.9 - 1.2																																																			
B	0.35 - 0.45	0.6 - 0.8	0.7 - 0.9																																																			
C	0.4 - 0.6	0.6 - 0.8	0.9 - 1.2																																																			
Type	CGA5 (CC1206)	CGA6 (CC1210)	CGA8 (CC1812)	CGA9 (CC2220)																																																		
A	2.0 - 2.4	2.0 - 2.4	3.1 - 3.7	4.1 - 4.8																																																		
B	1.0 - 1.2	1.0 - 1.2	1.2 - 1.4	1.2 - 1.4																																																		
C	1.1 - 1.6	1.9 - 2.5	2.4 - 3.2	4.0 - 5.0																																																		

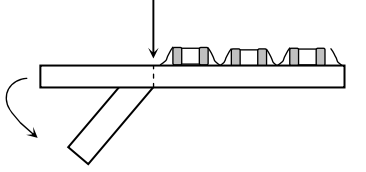
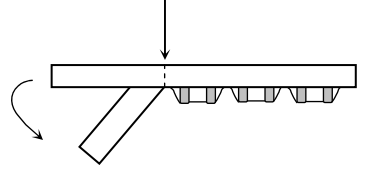
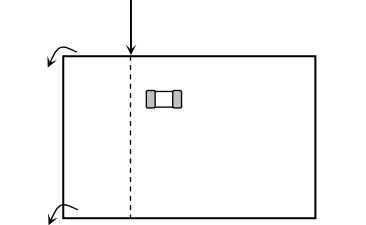
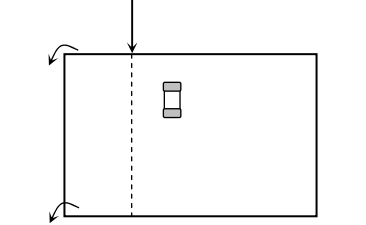
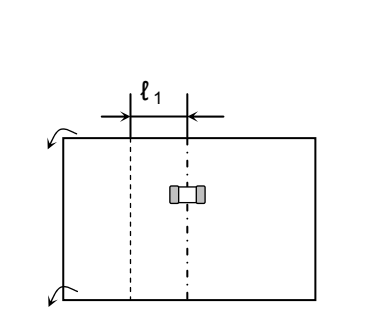
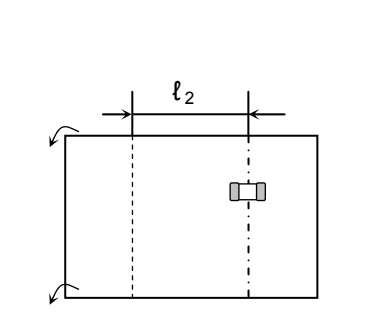
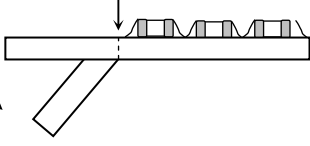
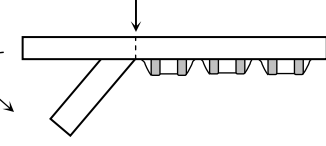
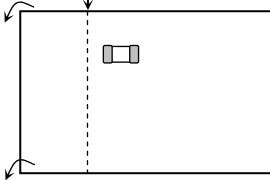
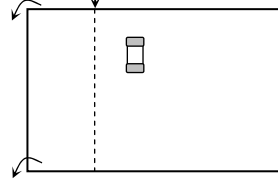
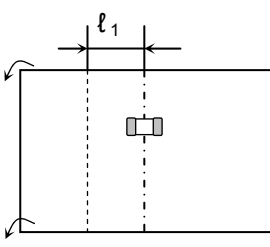
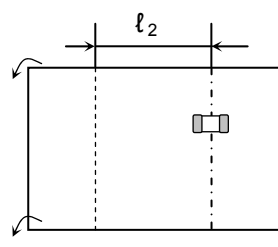
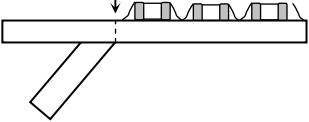
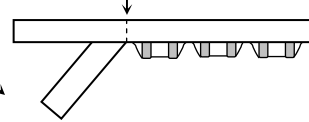
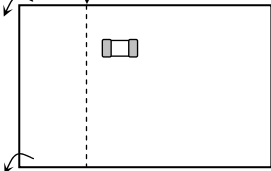
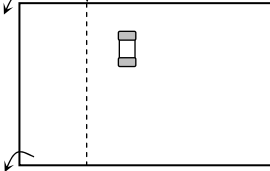
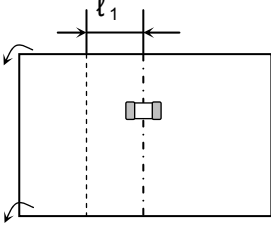
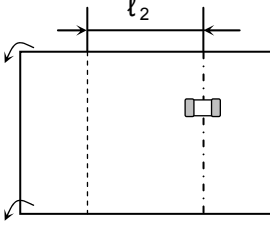
No.	Process	Condition												
3	Designing P.C. board	<p data-bbox="437 192 1098 226">4) Recommended chip capacitors layout is as following.</p> <table border="1" data-bbox="475 255 1430 1675"> <thead> <tr> <th data-bbox="475 255 660 331"></th> <th data-bbox="660 255 1043 331">Disadvantage against bending stress</th> <th data-bbox="1043 255 1430 331">Advantage against bending stress</th> </tr> </thead> <tbody> <tr> <td data-bbox="475 331 660 748">Mounting face</td> <td data-bbox="660 331 1043 748"> <p data-bbox="746 383 954 416">Perforation or slit</p>  <p data-bbox="699 645 954 712">Break P.C. board with mounted side up.</p> </td> <td data-bbox="1043 331 1430 748"> <p data-bbox="1129 383 1337 416">Perforation or slit</p>  <p data-bbox="1088 645 1343 712">Break P.C. board with mounted side down.</p> </td> </tr> <tr> <td data-bbox="475 748 660 1196">Chip arrangement (Direction)</td> <td data-bbox="660 748 1043 1196"> <p data-bbox="746 869 954 902">Perforation or slit</p>  </td> <td data-bbox="1043 748 1430 1196"> <p data-bbox="1129 869 1337 902">Perforation or slit</p>  </td> </tr> <tr> <td data-bbox="475 1196 660 1675">Distance from slit</td> <td data-bbox="660 1196 1043 1675"> <p data-bbox="673 1205 1002 1238">Closer to slit is higher stress</p>  <p data-bbox="896 1579 1008 1612">$(l_1 < l_2)$</p> </td> <td data-bbox="1043 1196 1430 1675"> <p data-bbox="1056 1205 1385 1238">Away from slit is less stress</p>  <p data-bbox="1286 1579 1398 1612">$(l_1 < l_2)$</p> </td> </tr> </tbody> </table>		Disadvantage against bending stress	Advantage against bending stress	Mounting face	<p data-bbox="746 383 954 416">Perforation or slit</p>  <p data-bbox="699 645 954 712">Break P.C. board with mounted side up.</p>	<p data-bbox="1129 383 1337 416">Perforation or slit</p>  <p data-bbox="1088 645 1343 712">Break P.C. board with mounted side down.</p>	Chip arrangement (Direction)	<p data-bbox="746 869 954 902">Perforation or slit</p> 	<p data-bbox="1129 869 1337 902">Perforation or slit</p> 	Distance from slit	<p data-bbox="673 1205 1002 1238">Closer to slit is higher stress</p>  <p data-bbox="896 1579 1008 1612">$(l_1 < l_2)$</p>	<p data-bbox="1056 1205 1385 1238">Away from slit is less stress</p>  <p data-bbox="1286 1579 1398 1612">$(l_1 < l_2)$</p>
	Disadvantage against bending stress	Advantage against bending stress												
Mounting face	<p data-bbox="746 383 954 416">Perforation or slit</p>  <p data-bbox="699 645 954 712">Break P.C. board with mounted side up.</p>	<p data-bbox="1129 383 1337 416">Perforation or slit</p>  <p data-bbox="1088 645 1343 712">Break P.C. board with mounted side down.</p>												
Chip arrangement (Direction)	<p data-bbox="746 869 954 902">Perforation or slit</p> 	<p data-bbox="1129 869 1337 902">Perforation or slit</p> 												
Distance from slit	<p data-bbox="673 1205 1002 1238">Closer to slit is higher stress</p>  <p data-bbox="896 1579 1008 1612">$(l_1 < l_2)$</p>	<p data-bbox="1056 1205 1385 1238">Away from slit is less stress</p>  <p data-bbox="1286 1579 1398 1612">$(l_1 < l_2)$</p>												

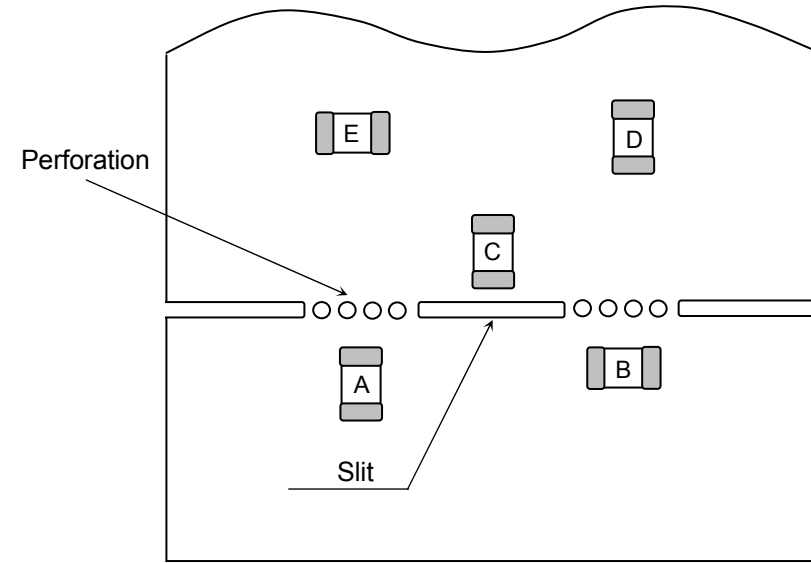
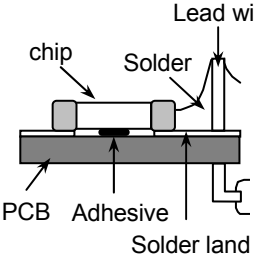
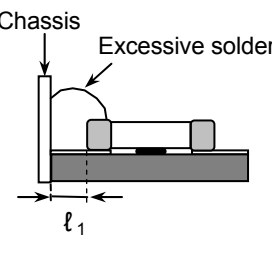
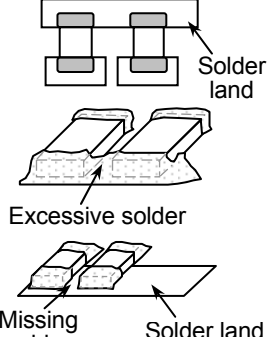
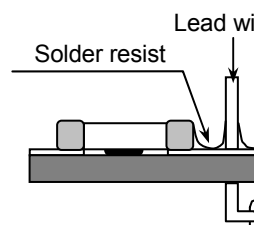
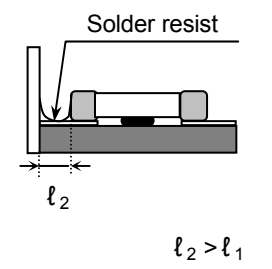
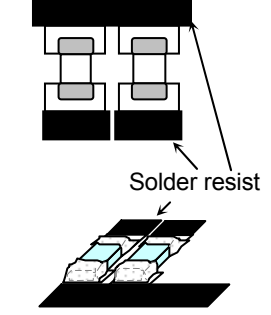
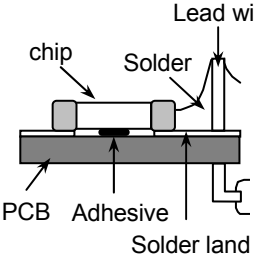
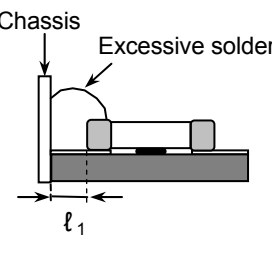
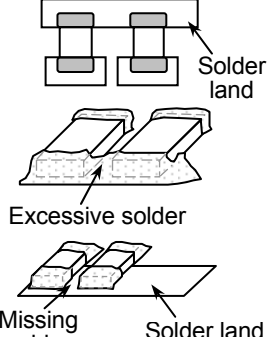
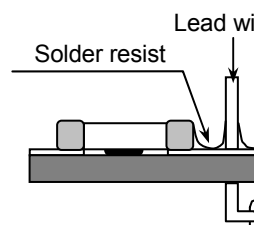
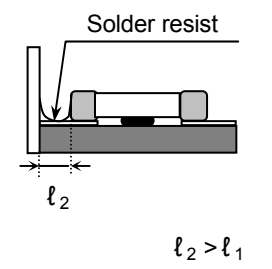
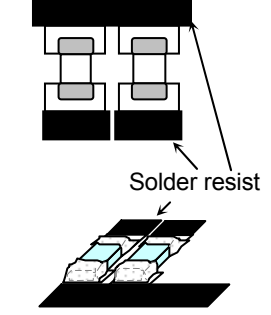
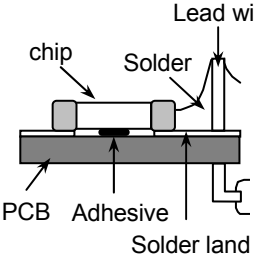
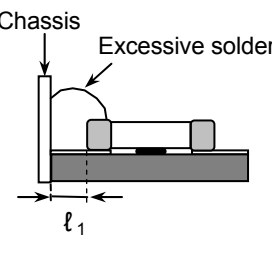
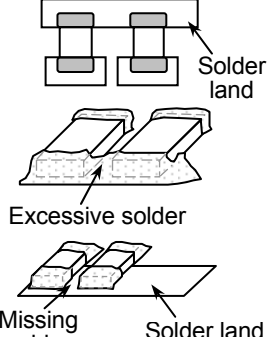
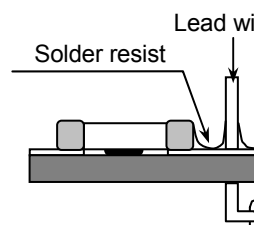
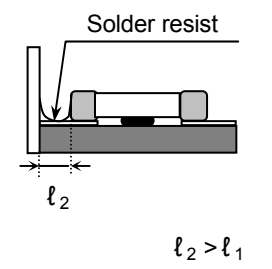
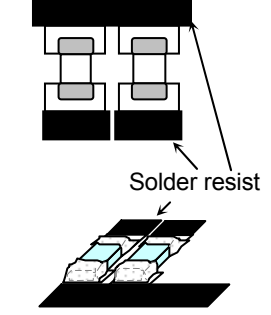
No.	Process	Condition												
3	Designing P.C. board	<p>5) Mechanical stress varies according to location of chip capacitors on the P.C. board.</p>  <p>The stress in capacitors is in the following order. $A > B = C > D > E$</p> <p>6) Layout recommendation</p> <table border="1"> <thead> <tr> <th data-bbox="379 1008 539 1120">Example</th> <th data-bbox="539 1008 842 1120">Use of common solder land</th> <th data-bbox="842 1008 1153 1120">Soldering with chassis</th> <th data-bbox="1153 1008 1489 1120">Use of common solder land with other SMD</th> </tr> </thead> <tbody> <tr> <td data-bbox="379 1120 539 1500">Need to avoid</td> <td data-bbox="539 1120 842 1500">  </td> <td data-bbox="842 1120 1153 1500">  </td> <td data-bbox="1153 1120 1489 1500">  </td> </tr> <tr> <td data-bbox="379 1500 539 1915">Recommendation</td> <td data-bbox="539 1500 842 1915">  </td> <td data-bbox="842 1500 1153 1915">  </td> <td data-bbox="1153 1500 1489 1915">  </td> </tr> </tbody> </table>	Example	Use of common solder land	Soldering with chassis	Use of common solder land with other SMD	Need to avoid				Recommendation			
Example	Use of common solder land	Soldering with chassis	Use of common solder land with other SMD											
Need to avoid														
Recommendation														

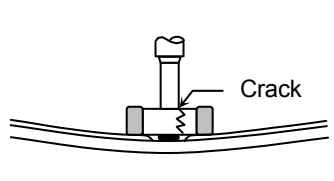
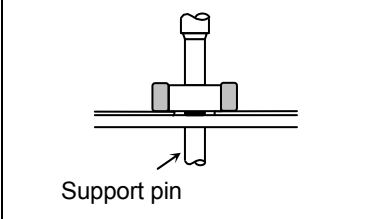
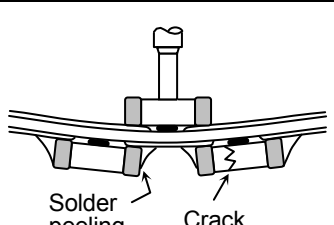
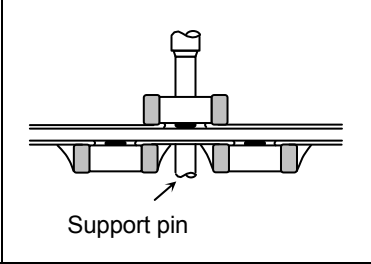
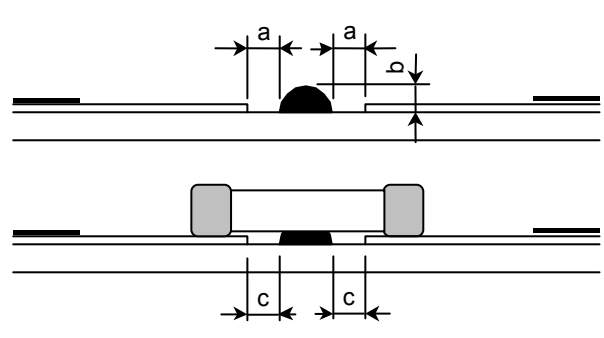
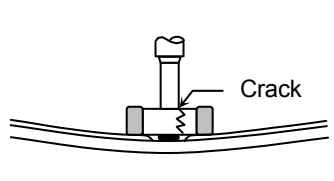
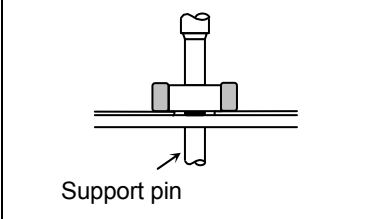
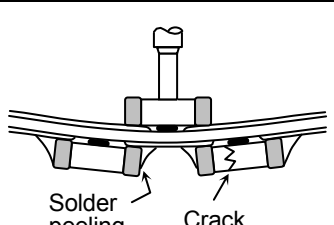
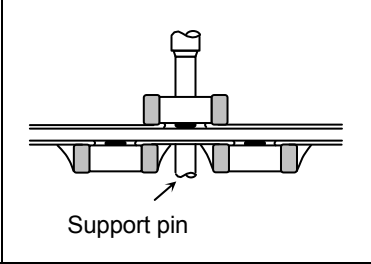
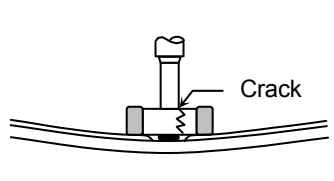
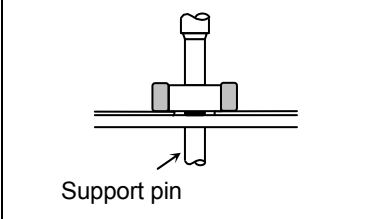
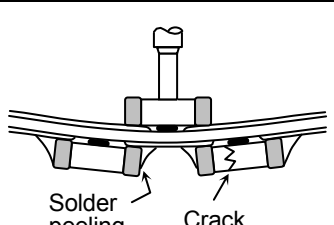
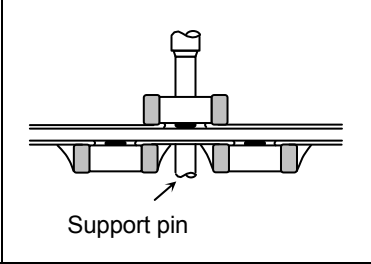
No.	Process	Condition															
4	Mounting	<p>4-1. Stress from mounting head</p> <p>If the mounting head is adjusted too low, it may induce excessive stress in the chip capacitors to result in cracking. Please take following precautions.</p> <ol style="list-style-type: none"> 1) Adjust the bottom dead center of the mounting head to reach on the P.C. board surface and not press it. 2) Adjust the mounting head pressure to be 1 to 3N of static weight. 3) To minimize the impact energy from mounting head, it is important to provide support from the bottom side of the P.C. board. See following examples. <table border="1" data-bbox="478 593 1436 1153"> <thead> <tr> <th></th> <th>Not recommended</th> <th>Recommended</th> </tr> </thead> <tbody> <tr> <td>Single sided mounting</td> <td></td> <td></td> </tr> <tr> <td>Double-sides mounting</td> <td></td> <td></td> </tr> </tbody> </table> <p>When the centering jaw is worn out, it may give mechanical impact on the capacitors to cause crack. Please control the close up dimension of the centering jaw and provide sufficient preventive maintenance and replacement of it.</p> <p>4-2. Amount of adhesive</p>  <p>Example : CGA4 (CC0805), CGA5 (CC1206)</p> <table border="1" data-bbox="654 1769 1212 1948"> <tbody> <tr> <td>a</td> <td>0.2mm min.</td> </tr> <tr> <td>b</td> <td>70 - 100μm</td> </tr> <tr> <td>c</td> <td>Do not touch the solder land</td> </tr> </tbody> </table>		Not recommended	Recommended	Single sided mounting			Double-sides mounting			a	0.2mm min.	b	70 - 100μm	c	Do not touch the solder land
	Not recommended	Recommended															
Single sided mounting																	
Double-sides mounting																	
a	0.2mm min.																
b	70 - 100μm																
c	Do not touch the solder land																

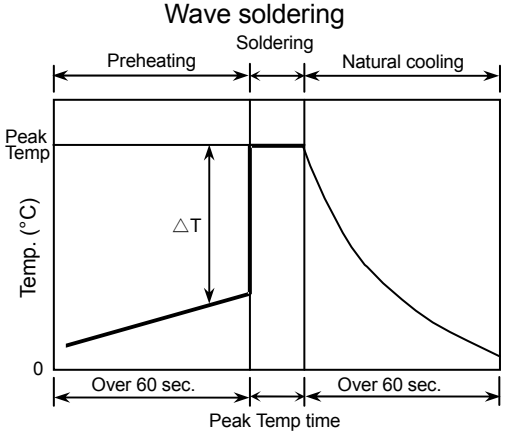
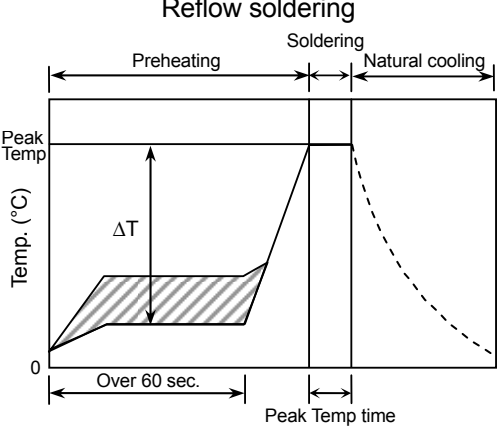
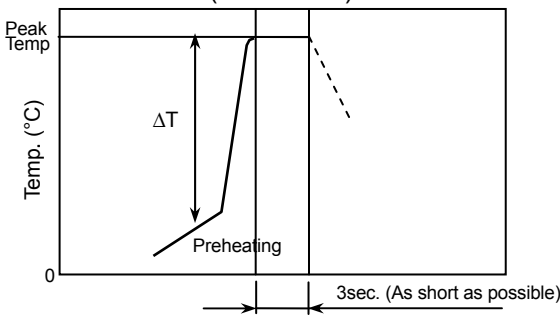
No.	Process	Condition																								
5	Soldering	<p>5-1. Flux selection</p> <p>Although highly-activated flux gives better solderability, substances which increase activity may also degrade the insulation of the chip capacitors. To avoid such degradation, it is recommended following.</p> <ol style="list-style-type: none"> 1) It is recommended to use a mildly activated rosin flux (less than 0.1wt% chlorine). Strong flux is not recommended. 2) Excessive flux must be avoided. Please provide proper amount of flux. 3) When water-soluble flux is used, enough washing is necessary. <p>5-2. Recommended soldering profile by various methods</p> <div style="display: flex; justify-content: space-around;"> <div style="text-align: center;"> <p>Wave soldering</p>  </div> <div style="text-align: center;"> <p>Reflow soldering</p>  </div> </div> <div style="text-align: center; margin-top: 20px;"> <p>Manual soldering (Solder iron)</p>  </div> <div style="margin-top: 20px;"> <p>APPLICATION</p> <p>As for CGA3 (CC0603), CGA4 (CC0805) and CGA5 (CC1206), applied to wave soldering and reflow soldering.</p> <p>As for CGA2 (CC0402), CGA6 (CC1210), CGA8 (CC1812) and CGA9 (CC2220), applied only to reflow soldering.</p> </div> <p>※ As for peak temperature of manual soldering, please refer “5-6. Solder repair by solder iron” .</p> <p>5-3. Recommended soldering peak temp and peak temp duration</p> <table border="1" style="width: 100%; border-collapse: collapse; text-align: center;"> <thead> <tr> <th rowspan="2" style="text-align: left;">Temp./Duration</th> <th colspan="2">Wave soldering</th> <th colspan="2">Reflow soldering</th> </tr> <tr> <th>Peak temp(°C)</th> <th>Duration(sec.)</th> <th>Peak temp(°C)</th> <th>Duration(sec.)</th> </tr> </thead> <tbody> <tr> <td style="text-align: left;">Solder</td> <td></td> <td></td> <td></td> <td></td> </tr> <tr> <td style="text-align: left;">Sn-Pb Solder</td> <td>250 max.</td> <td>3 max.</td> <td>230 max.</td> <td>20 max.</td> </tr> <tr> <td style="text-align: left;">Lead Free Solder</td> <td>260 max.</td> <td>5 max.</td> <td>260 max.</td> <td>10 max.</td> </tr> </tbody> </table> <p>Recommended solder compositions</p> <p>Sn-37Pb (Sn-Pb solder)</p> <p>Sn-3.0Ag-0.5Cu (Lead Free Solder)</p>	Temp./Duration	Wave soldering		Reflow soldering		Peak temp(°C)	Duration(sec.)	Peak temp(°C)	Duration(sec.)	Solder					Sn-Pb Solder	250 max.	3 max.	230 max.	20 max.	Lead Free Solder	260 max.	5 max.	260 max.	10 max.
Temp./Duration	Wave soldering			Reflow soldering																						
	Peak temp(°C)	Duration(sec.)	Peak temp(°C)	Duration(sec.)																						
Solder																										
Sn-Pb Solder	250 max.	3 max.	230 max.	20 max.																						
Lead Free Solder	260 max.	5 max.	260 max.	10 max.																						

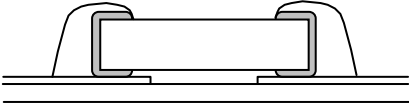
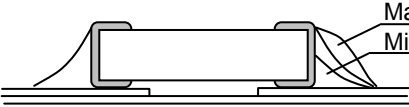
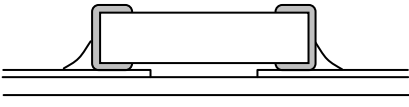
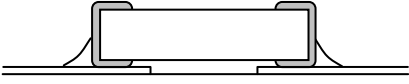
No.	Process	Condition																												
5	Soldering	<p>5-4. Avoiding thermal shock</p> <p>1) Preheating condition</p> <table border="1" data-bbox="555 255 1428 622"> <thead> <tr> <th>Soldering</th> <th>Type</th> <th>Temp. (°C)</th> </tr> </thead> <tbody> <tr> <td>Wave soldering</td> <td>CGA3(CC0603), CGA4(CC0805), CGA5(CC1206)</td> <td>$\Delta T \leq 150$</td> </tr> <tr> <td rowspan="2">Reflow soldering</td> <td>CGA2(CC0402), CGA3(CC0603), CGA4(CC0805), CGA5(CC1206)</td> <td>$\Delta T \leq 150$</td> </tr> <tr> <td>CGA6(CC1210), CGA8(CC1812), CGA9(CC2220)</td> <td>$\Delta T \leq 130$</td> </tr> <tr> <td rowspan="2">Manual soldering</td> <td>CGA2(CC0402), CGA3(CC0603), CGA4(CC0805), CGA5(CC1206)</td> <td>$\Delta T \leq 150$</td> </tr> <tr> <td>CGA6(CC1210), CGA8(CC1812), CGA9(CC2220)</td> <td>$\Delta T \leq 130$</td> </tr> </tbody> </table> <p>2) Cooling condition Natural cooling using air is recommended. If the chips are dipped into a solvent for cleaning, the temperature difference (ΔT) must be less than 100°C.</p> <p>5-5. Amount of solder Excessive solder will induce higher tensile force in chip capacitors when temperature changes and it may result in chip cracking. In sufficient solder may detach the capacitors from the P.C. board.</p> <div style="display: flex; justify-content: space-between; align-items: flex-start;"> <div style="width: 30%;"> <p>Excessive solder</p>  </div> <div style="width: 30%; text-align: center;">  </div> <div style="width: 30%;"> <p>Higher tensile force in chip capacitors to cause crack</p> </div> </div> <div style="display: flex; justify-content: space-between; align-items: flex-start; margin-top: 10px;"> <div style="width: 30%;"> <p>Adequate</p>  </div> <div style="width: 30%; text-align: center;"> <p>Maximum amount</p> <p>Minimum amount</p> </div> </div> <div style="display: flex; justify-content: space-between; align-items: flex-start; margin-top: 10px;"> <div style="width: 30%;"> <p>Insufficient solder</p>  </div> <div style="width: 30%;"> <p>Low robustness may cause contact failure or chip capacitors come off the P.C. board.</p> </div> </div> <p>5-6. Solder repair by solder iron</p> <p>1) Selection of the soldering iron tip Tip temperature of solder iron varies by its type, P.C. board material and solder land size. The higher the tip temperature, the quicker the operation. However, heat shock may cause a crack in the chip capacitors. Please make sure the tip temp. before soldering and keep the peak temp and time in accordance with following recommended condition. (Please preheat the chip capacitors with the condition in 5-4 to avoid the thermal shock.)</p> <p style="text-align: center;">Recommended solder iron condition (Sn-Pb Solder and Lead Free Solder)</p> <table border="1" data-bbox="496 1727 1445 2011"> <thead> <tr> <th>Type</th> <th>Temp. (°C)</th> <th>Duration (sec.)</th> <th>Wattage (W)</th> <th>Shape (mm)</th> </tr> </thead> <tbody> <tr> <td>CGA2(CC0402) CGA3(CC0603) CGA4(CC0805) CGA5(CC1206)</td> <td>350 max.</td> <td rowspan="2">3 max.</td> <td rowspan="2">20 max.</td> <td rowspan="2">Ø 3.0 max.</td> </tr> <tr> <td>CGA6(CC1210) CGA8(CC1812) CGA9(CC2220)</td> <td>280 max.</td> </tr> </tbody> </table>	Soldering	Type	Temp. (°C)	Wave soldering	CGA3(CC0603), CGA4(CC0805), CGA5(CC1206)	$\Delta T \leq 150$	Reflow soldering	CGA2(CC0402), CGA3(CC0603), CGA4(CC0805), CGA5(CC1206)	$\Delta T \leq 150$	CGA6(CC1210), CGA8(CC1812), CGA9(CC2220)	$\Delta T \leq 130$	Manual soldering	CGA2(CC0402), CGA3(CC0603), CGA4(CC0805), CGA5(CC1206)	$\Delta T \leq 150$	CGA6(CC1210), CGA8(CC1812), CGA9(CC2220)	$\Delta T \leq 130$	Type	Temp. (°C)	Duration (sec.)	Wattage (W)	Shape (mm)	CGA2(CC0402) CGA3(CC0603) CGA4(CC0805) CGA5(CC1206)	350 max.	3 max.	20 max.	Ø 3.0 max.	CGA6(CC1210) CGA8(CC1812) CGA9(CC2220)	280 max.
Soldering	Type	Temp. (°C)																												
Wave soldering	CGA3(CC0603), CGA4(CC0805), CGA5(CC1206)	$\Delta T \leq 150$																												
Reflow soldering	CGA2(CC0402), CGA3(CC0603), CGA4(CC0805), CGA5(CC1206)	$\Delta T \leq 150$																												
	CGA6(CC1210), CGA8(CC1812), CGA9(CC2220)	$\Delta T \leq 130$																												
Manual soldering	CGA2(CC0402), CGA3(CC0603), CGA4(CC0805), CGA5(CC1206)	$\Delta T \leq 150$																												
	CGA6(CC1210), CGA8(CC1812), CGA9(CC2220)	$\Delta T \leq 130$																												
Type	Temp. (°C)	Duration (sec.)	Wattage (W)	Shape (mm)																										
CGA2(CC0402) CGA3(CC0603) CGA4(CC0805) CGA5(CC1206)	350 max.	3 max.	20 max.	Ø 3.0 max.																										
CGA6(CC1210) CGA8(CC1812) CGA9(CC2220)	280 max.																													

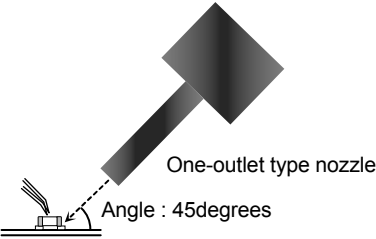
No.	Process	Condition												
5	Soldering	<p>2) Direct contact of the soldering iron with ceramic dielectric of chip capacitors may cause crack. Do not touch the ceramic dielectric and the terminations by solder iron.</p> <p>5-7.Soldering rework using spot heater Heat stress during rework may possibly be reduced by using a spot heater (also called a “blower”) rather than a soldering iron. It is applied only to adding solder in the case of insufficient solder amount.</p> <p>1) Reworking using a spot heater may suppress the occurrence of cracks in the capacitor compared to using a soldering iron. A spot heater can heat up a capacitor uniformly with a small heat gradient which leads to lower thermal stress caused by quick heating and cooling or localized heating. Moreover, where ultra-small capacitors are mounted close together on a printed circuit board, reworking with a spot heater can eliminate the risk of direct contact between the tip of a soldering iron and a capacitor.</p> <p>2) Rework condition If the blower nozzle of a spot heater is too close to a capacitor, a crack in the capacitor may occur due to heat stress. Below are recommendations for avoiding such an occurrence. Keep more than 5mm between a capacitor and a spot heater nozzle. The blower temperature of the spot heater shall be lower than 400°C. The airflow shall be set as weak as possible. The diameter of the nozzle is recommended to be 2mm(one-outlet type).The size is standard and common. Duration of blowing hot air is recommended to be 10s or less for CGA3 (CC0603), CGA4 (CC0805) and CGA5 (CC1206), and 30s or less for CGA6 (CC1210), CGA8(CC1812) and CGA9 (CC2220), considering surface area of the capacitor and melting temperature of solder. The angle between the nozzle and the capacitor is recommended to be 45degrees in order to work easily and to avoid partial area heating. As is the case when using a soldering iron, preheating reduces thermal stress on capacitors and improves operating efficiency.</p> <p>• Recommended rework condition (Consult the component manufactures for details.)</p> <table border="1" data-bbox="523 1330 1465 1680"> <tbody> <tr> <td>Distance from nozzle</td> <td>5mm and over</td> </tr> <tr> <td>Nozzle angle</td> <td>45degrees</td> </tr> <tr> <td>Nozzle temp.</td> <td>400°C and less</td> </tr> <tr> <td>Airflow</td> <td>Set as weak as possible (The airflow shall be the minimum value necessary for solder to melt in the conditions mentioned above.)</td> </tr> <tr> <td>Nozzle diameter</td> <td>φ 2mm (one-outlet type)</td> </tr> <tr> <td>Blowing duration</td> <td>10s and less (CGA3 [CC0603], CGA4 [CC0805], CGA5 [CC1206]) 30s and less (CGA6 [CC1210], CGA8 [CC1812], CGA9 [CC2220])</td> </tr> </tbody> </table> <p>• Example of recommended spot heater use</p> 	Distance from nozzle	5mm and over	Nozzle angle	45degrees	Nozzle temp.	400°C and less	Airflow	Set as weak as possible (The airflow shall be the minimum value necessary for solder to melt in the conditions mentioned above.)	Nozzle diameter	φ 2mm (one-outlet type)	Blowing duration	10s and less (CGA3 [CC0603], CGA4 [CC0805], CGA5 [CC1206]) 30s and less (CGA6 [CC1210], CGA8 [CC1812], CGA9 [CC2220])
Distance from nozzle	5mm and over													
Nozzle angle	45degrees													
Nozzle temp.	400°C and less													
Airflow	Set as weak as possible (The airflow shall be the minimum value necessary for solder to melt in the conditions mentioned above.)													
Nozzle diameter	φ 2mm (one-outlet type)													
Blowing duration	10s and less (CGA3 [CC0603], CGA4 [CC0805], CGA5 [CC1206]) 30s and less (CGA6 [CC1210], CGA8 [CC1812], CGA9 [CC2220])													

No.	Process	Condition
5	Soldering	<p>3) Amount of solder should be suitable to form a proper fillet shape. Excess solder causes mechanical and thermal stress on a capacitor and results in cracks. Insufficient solder causes weak adherence of the capacitor to the substrate and may result in detachment of a capacitor and deteriorate reliability of the printed wiring board. See the example of appropriate solder fillet shape for 5-5.Amount of solder.</p> <p>5-8. Sn-Zn solder Sn-Zn solder affects product reliability. Please contact TDK in advance when utilize Sn-Zn solder.</p> <p>5-9. Countermeasure for tombstone The misalignment between the mounted positions of the capacitors and the land patterns should be minimized. The tombstone phenomenon may occur especially the capacitors are mounted (in longitudinal direction) in the same direction of the reflow soldering. (Refer to JEITA RCR-2335C Annex A (Informative) Recommendations to prevent the tombstone phenomenon)</p>
6	Cleaning	<p>1) If an unsuitable cleaning fluid is used, flux residue or some foreign articles may stick to chip capacitors surface to deteriorate especially the insulation resistance.</p> <p>2) If cleaning condition is not suitable, it may damage the chip capacitors.</p> <p>2)-1. Insufficient washing (1) Terminal electrodes may corrode by Halogen in the flux. (2) Halogen in the flux may adhere on the surface of capacitors, and lower the insulation resistance. (3) Water soluble flux has higher tendency to have above mentioned problems (1) and (2).</p> <p>2)-2. Excessive washing When ultrasonic cleaning is used, excessively high ultrasonic energy output can affect the connection between the ceramic chip capacitor's body and the terminal electrode. To avoid this, following is the recommended condition. Power : 20 W/ℓ max. Frequency : 40 kHz max. Washing time : 5 minutes max.</p> <p>2)-3. If the cleaning fluid is contaminated, density of Halogen increases, and it may bring the same result as insufficient cleaning.</p>

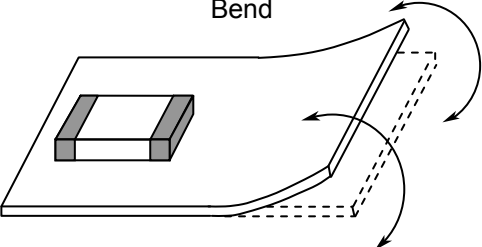
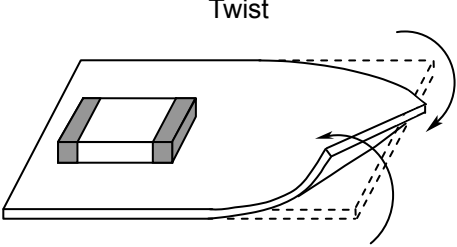
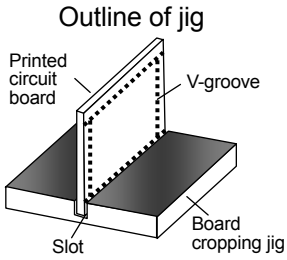
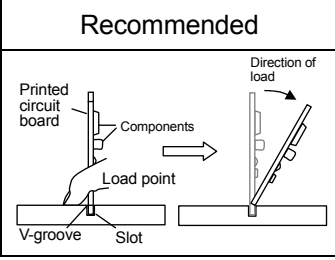
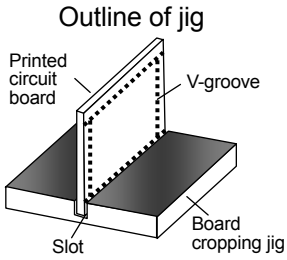
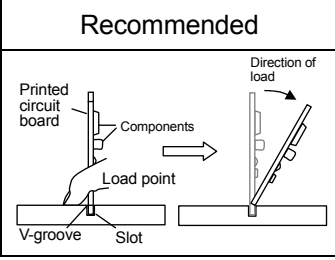
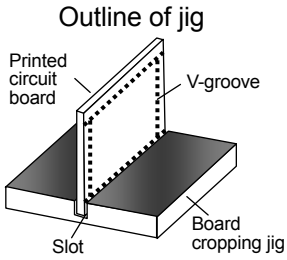
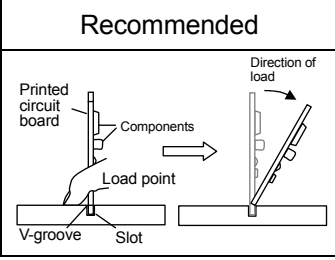
No.	Process	Condition				
7	Coating and molding of the P.C. board	1) When the P.C. board is coated, please verify the quality influence on the product. 2) Please verify carefully that there is no harmful decomposing or reaction gas emission during curing which may damage the chip capacitors. 3) Please verify the curing temperature.				
8	Handling after chip mounted ⚠ Caution	1) Please pay attention not to bend or distort the P.C. board after soldering in handling otherwise the chip capacitors may crack. <div style="text-align: center;">  </div> 2) Printed circuit board cropping should not be carried out by hand, but by using the proper tooling. Printed circuit board cropping should be carried out using a board cropping jig as shown in the following figure or a board cropping apparatus to prevent inducing mechanical stress on the board. (1) Example of a board cropping jig Recommended example: The board should be pushed from the back side, close to the cropping jig so that the board is not bent and the stress applied to the capacitor is compressive. Unrecommended example: If the pushing point is far from the cropping jig and the pushing direction is from the front side of the board, large tensile stress is applied to the capacitor, which may cause cracks. <div style="display: flex; justify-content: space-around; align-items: flex-start;"> <div data-bbox="475 1193 762 1451" style="text-align: center;">  <p>Outline of jig</p> </div> <table border="1" data-bbox="778 1187 1457 1451"> <thead> <tr> <th data-bbox="778 1187 1114 1243">Recommended</th> <th data-bbox="1114 1187 1457 1243">Unrecommended</th> </tr> </thead> <tbody> <tr> <td data-bbox="778 1243 1114 1451">  </td> <td data-bbox="1114 1243 1457 1451">  </td> </tr> </tbody> </table> </div>	Recommended	Unrecommended		
Recommended	Unrecommended					
						

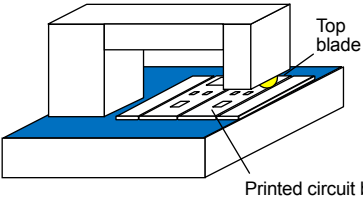
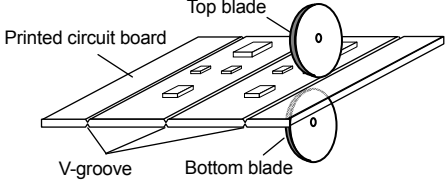
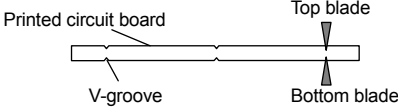
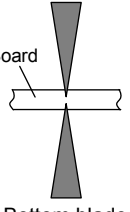
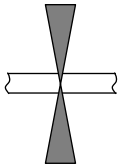
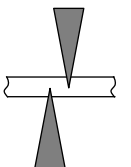
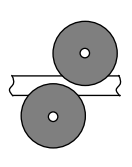
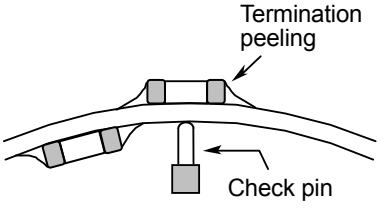
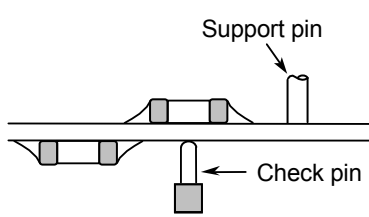
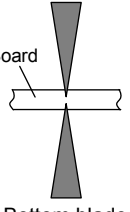
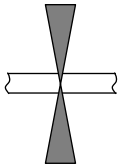
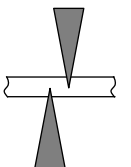
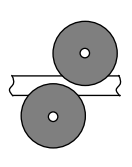
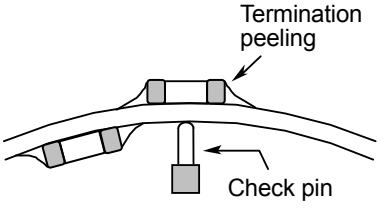
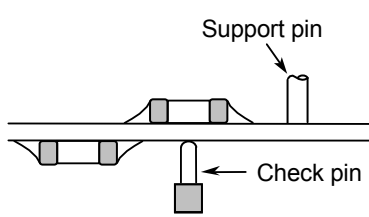
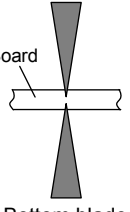
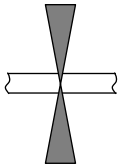
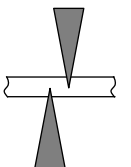
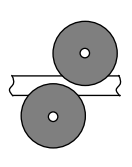
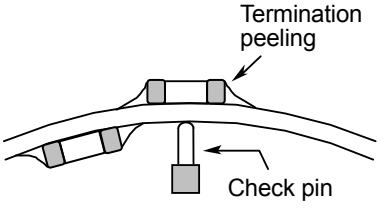
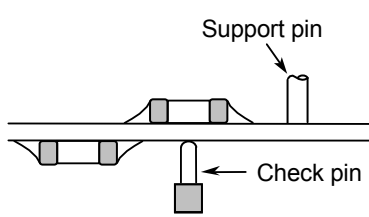
No.	Process	Condition																		
8	Handling after chip mounted ⚠ Caution	<p data-bbox="539 230 1018 259">(2) Example of a board cropping machine</p> <p data-bbox="571 268 1458 371">An outline of a printed circuit board cropping machine is shown below. The top and bottom blades are aligned with one another along the lines with the V-grooves on printed circuit board when cropping the board.</p> <p data-bbox="571 380 1474 483">Unrecommended example: Misalignment of blade position between top and bottom, right and left, or front and rear blades may cause a crack in the capacitor.</p> <div data-bbox="571 533 1442 967"> <p data-bbox="679 533 877 562">Outline of machine</p>  <p data-bbox="1104 533 1327 562">Principle of operation</p>  <p data-bbox="1139 815 1378 844">Cross-section diagram</p>  </div> <table border="1" data-bbox="657 1012 1366 1438"> <thead> <tr> <th data-bbox="657 1012 836 1093">Recommended</th> <th colspan="3" data-bbox="836 1012 1366 1093">Unrecommended</th> </tr> <tr> <th data-bbox="657 1093 836 1137"></th> <th data-bbox="836 1093 1015 1137">Top-bottom misalignment</th> <th data-bbox="1015 1093 1187 1137">Left-right misalignment</th> <th data-bbox="1187 1093 1366 1137">Front-rear misalignment</th> </tr> </thead> <tbody> <tr> <td data-bbox="657 1137 836 1438"> <p data-bbox="699 1126 798 1155">Top blade</p>  <p data-bbox="683 1375 813 1404">Bottom blade</p> </td> <td data-bbox="836 1137 1015 1438"> <p data-bbox="877 1171 976 1200">Top blade</p>  <p data-bbox="868 1375 999 1404">Bottom blade</p> </td> <td data-bbox="1015 1137 1187 1438"> <p data-bbox="1056 1171 1155 1200">Top blade</p>  <p data-bbox="1040 1375 1171 1404">Bottom blade</p> </td> <td data-bbox="1187 1137 1366 1438"> <p data-bbox="1228 1171 1327 1200">Top blade</p>  <p data-bbox="1212 1375 1343 1404">Bottom blade</p> </td> </tr> </tbody> </table> <p data-bbox="488 1482 1474 1626">3) When functional check of the P.C. board is performed, check pin pressure tends to be adjusted higher for fear of loose contact. But if the pressure is excessive and bend the P.C. board, it may crack the chip capacitors or peel the terminations off. Please adjust the check pins not to bend the P.C. board.</p> <table border="1" data-bbox="491 1680 1445 1975"> <thead> <tr> <th data-bbox="491 1680 628 1742">Item</th> <th data-bbox="628 1680 1046 1742">Not recommended</th> <th data-bbox="1046 1680 1445 1742">Recommended</th> </tr> </thead> <tbody> <tr> <td data-bbox="491 1742 628 1975">Board bending</td> <td data-bbox="628 1742 1046 1975">  <p data-bbox="877 1751 1008 1803">Termination peeling</p> <p data-bbox="868 1921 979 1951">Check pin</p> </td> <td data-bbox="1046 1742 1445 1975">  <p data-bbox="1267 1765 1398 1794">Support pin</p> <p data-bbox="1321 1906 1433 1935">Check pin</p> </td> </tr> </tbody> </table>	Recommended	Unrecommended				Top-bottom misalignment	Left-right misalignment	Front-rear misalignment	<p data-bbox="699 1126 798 1155">Top blade</p>  <p data-bbox="683 1375 813 1404">Bottom blade</p>	<p data-bbox="877 1171 976 1200">Top blade</p>  <p data-bbox="868 1375 999 1404">Bottom blade</p>	<p data-bbox="1056 1171 1155 1200">Top blade</p>  <p data-bbox="1040 1375 1171 1404">Bottom blade</p>	<p data-bbox="1228 1171 1327 1200">Top blade</p>  <p data-bbox="1212 1375 1343 1404">Bottom blade</p>	Item	Not recommended	Recommended	Board bending	 <p data-bbox="877 1751 1008 1803">Termination peeling</p> <p data-bbox="868 1921 979 1951">Check pin</p>	 <p data-bbox="1267 1765 1398 1794">Support pin</p> <p data-bbox="1321 1906 1433 1935">Check pin</p>
Recommended	Unrecommended																			
	Top-bottom misalignment	Left-right misalignment	Front-rear misalignment																	
<p data-bbox="699 1126 798 1155">Top blade</p>  <p data-bbox="683 1375 813 1404">Bottom blade</p>	<p data-bbox="877 1171 976 1200">Top blade</p>  <p data-bbox="868 1375 999 1404">Bottom blade</p>	<p data-bbox="1056 1171 1155 1200">Top blade</p>  <p data-bbox="1040 1375 1171 1404">Bottom blade</p>	<p data-bbox="1228 1171 1327 1200">Top blade</p>  <p data-bbox="1212 1375 1343 1404">Bottom blade</p>																	
Item	Not recommended	Recommended																		
Board bending	 <p data-bbox="877 1751 1008 1803">Termination peeling</p> <p data-bbox="868 1921 979 1951">Check pin</p>	 <p data-bbox="1267 1765 1398 1794">Support pin</p> <p data-bbox="1321 1906 1433 1935">Check pin</p>																		

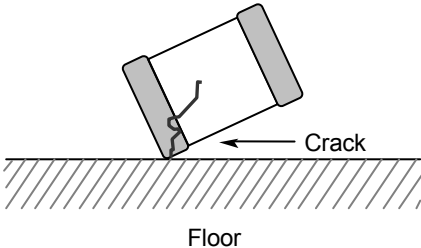
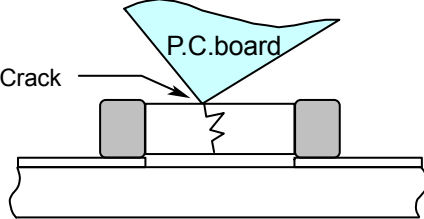
No.	Process	Condition
9	Handling of loose chip capacitors	<p>1) If dropped the chip capacitors may crack. Once dropped do not use it. Especially, the large case sized chip capacitors are tendency to have cracks easily, so please handle with care.</p>  <p>2) Piling the P.C. board after mounting for storage or handling, the corner of the P.C. board may hit the chip capacitors of another board to cause crack.</p> 
10	Capacitance aging	The capacitors (Class 2) have aging in the capacitance. They may not be used in precision time constant circuit. In case of the time constant circuit, the evaluation should be done well.
11	Estimated life and estimated failure rate of capacitors	As per the estimated life and the estimated failure rate depend on the temperature and the voltage. This can be calculated by the equation described in JEITA RCR-2335C Annex F (Informative) Calculation of the estimated lifetime and the estimated failure rate (Voltage acceleration coefficient : 3 multiplication rule, Temperature acceleration coefficient : 10°C rule) The failure rate can be decreased by reducing the temperature and the voltage but they will not be guaranteed.

No.	Process	Condition
12	Caution during operation of equipment	<p>1) A capacitor shall not be touched directly with bare hands during operation in order to avoid electric shock. Electric energy held by the capacitor may be discharged through the human body when touched with a bare hand. Even when the equipment is off, a capacitor may stay charged. The capacitor should be handled after being completely discharged using a resistor.</p> <p>2) The terminals of a capacitor shall not be short-circuited by any accidental contact with a conductive object. A capacitor shall not be exposed to a conductive liquid such as an acid or alkali solution. A conductive object or liquid, such as acid and alkali, between the terminals may lead to the breakdown of a capacitor due to short circuit</p> <p>3) Confirm that the environment to which the equipment will be exposed during transportation and operation meets the specified conditions. Do not to use the equipment in the following environments.</p> <p>(1) Environment where a capacitor is spattered with water or oil (2) Environment where a capacitor is exposed to direct sunlight (3) Environment where a capacitor is exposed to Ozone, ultraviolet rays or radiation (4) Environment where a capacitor exposed to corrosive gas(e.g. hydrogen sulfide, sulfur dioxide, chlorine. ammonia gas etc.) (5) Environment where a capacitor exposed to vibration or mechanical shock exceeding the specified limits. (6) Atmosphere change with causes condensation</p>
13	Others  Caution	<p>The products listed on this specification sheet are intended for use in general electronic equipment (AV equipment, telecommunications equipment, home appliances, amusement equipment, computer equipment, personal equipment, office equipment, measurement equipment, industrial robots) and automotive application under a normal operation and use condition.</p> <p>The products are not designed or warranted to meet the requirements of the applications listed below, whose performance and/or quality require a more stringent level of safety or reliability, or whose failure, malfunction or trouble could cause serious damage to society, person or property. Please understand that we are not responsible for any damage or liability caused by use of the products in any of the applications below or for any other use exceeding the range or conditions set forth in this specification sheet. If you intend to use the products in the applications listed below or if you have special requirements exceeding the range or conditions set forth in this specification, please contact us.</p> <p>(1) Aerospace/Aviation equipment (2) Transportation equipment (electric trains, ships, etc. except automotive application) (3) Medical equipment (Excepting Pharmaceutical Affairs Law classification Class1, 2) (4) Power-generation control equipment (5) Atomic energy-related equipment (6) Seabed equipment (7) Transportation control equipment (8) Public information-processing equipment (9) Military equipment (10) Electric heating apparatus, burning equipment (11) Disaster prevention/crime prevention equipment (12) Safety equipment (13) Other applications that are not considered general-purpose applications</p> <p>When designing your equipment even for general-purpose applications, you are kindly requested to take into consideration securing protection circuit/device or providing backup circuits in your equipment.</p>

14. TAPE PACKAGING SPECIFICATION

1. CONSTRUCTION AND DIMENSION OF TAPING

1-1. Dimensions of carrier tape

Dimensions of paper tape shall be according to Appendix 3, 4.

Dimensions of plastic tape shall be according to Appendix 5, 6.

1-2. Bulk part and leader of taping

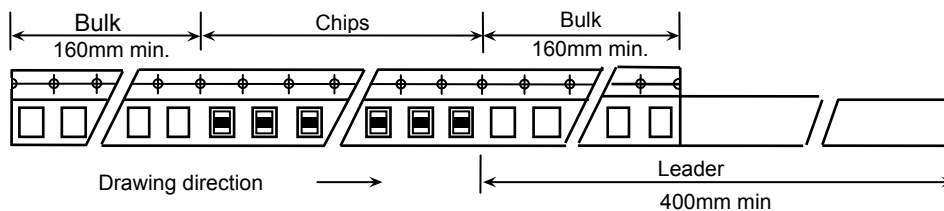

1-3. Dimensions of reel

Dimensions of Ø178 reel shall be according to Appendix 7, 8.

Dimensions of Ø330 reel shall be according to Appendix 9, 10.

1-4. Structure of taping

(a) Paper

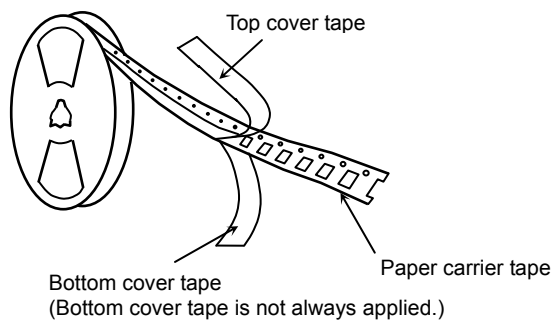

(b) Plastic

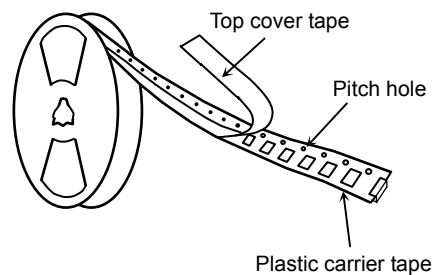

2. CHIP QUANTITY

As for chip quantity and taping material of each product, please refer to detailed information on TDK web.

3. PERFORMANCE SPECIFICATIONS

3-1. Fixing peeling strength (top tape)

0.05-0.7N. (See the following figure.)

〈Paper〉

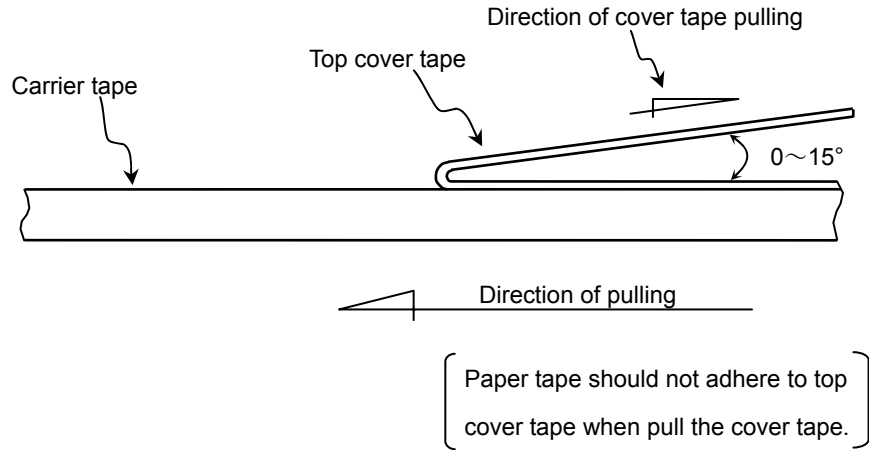

〈Plastic〉

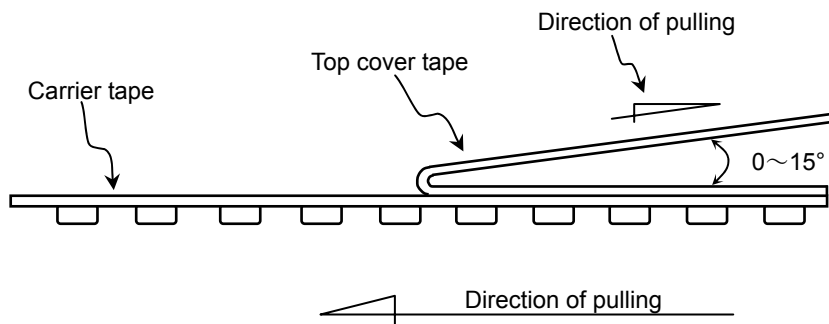

3-2. Carrier tape shall be flexible enough to be wound around a minimum radius of 30mm with components in tape.

3-3. The missing of components shall be less than 0.1%

3-4. Components shall not stick to fixing tape.

3-5. The fixing tapes shall not protrude beyond the edges of the carrier tape not shall cover the sprocket holes.

Appendix 3

Paper Tape

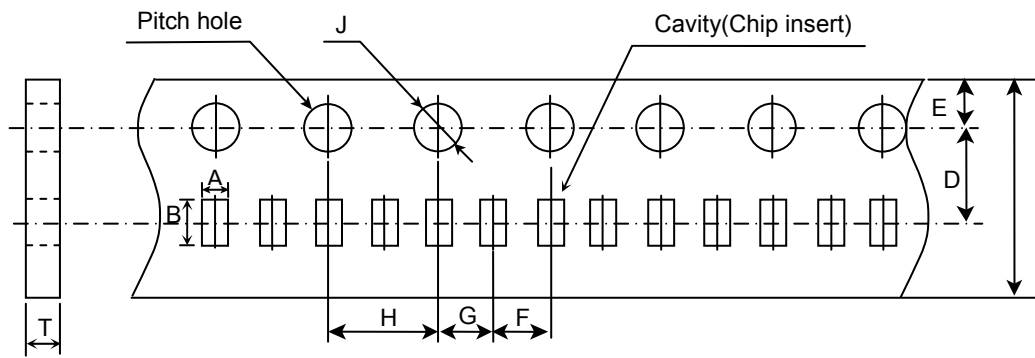

(Unit : mm)

Symbol Type	A	B	C	D	E	F
CGA2 (CC0402)	(0.65)	(1.15)	8.00 ± 0.30	3.50 ± 0.05	1.75 ± 0.10	2.00 ± 0.05
Symbol Type	G	H	J	T		
CGA2 (CC0402)	2.00 ± 0.05	4.00 ± 0.10	∅ 1.50 ^{+0.10} ₀	0.60 ± 0.15		

() Reference value.

Appendix 4

Paper Tape

(Paper tape shall be used for parts having a thickness of less than 1.0mm)

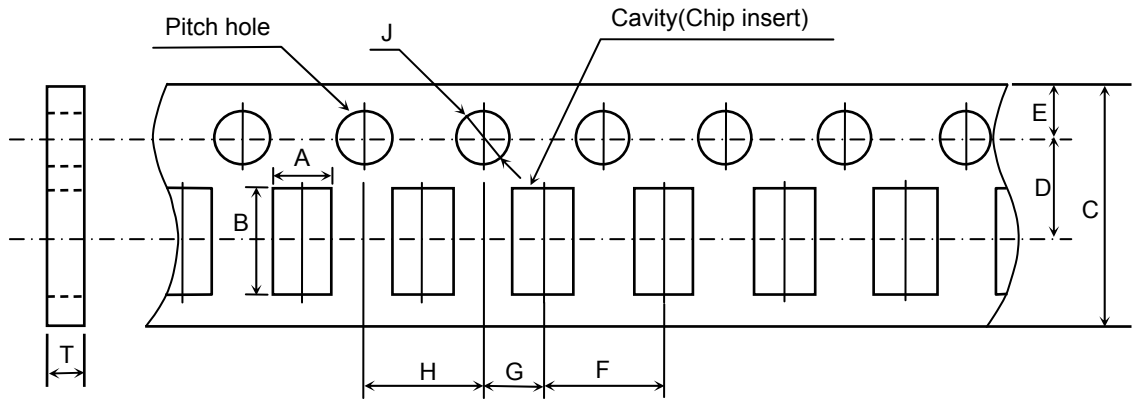

(Unit : mm)

Symbol Type	A	B	C	D	E	F
CGA3 (CC0603)	(1.10)	(1.90)	8.00 ± 0.30	3.50 ± 0.05	1.75 ± 0.10	4.00 ± 0.10
CGA4 (CC0805)	(1.50)	(2.30)				
CGA5 (CC1206)	(1.90)	(3.50)				

Symbol Type	G	H	J	T
CGA3 (CC0603)	2.00 ± 0.05	4.00 ± 0.10	∅ 1.50 $\begin{matrix} +0.10 \\ 0 \end{matrix}$	1.20 max.
CGA4 (CC0805)				
CGA5 (CC1206)				

() Reference value.

Appendix 5

Plastic Tape

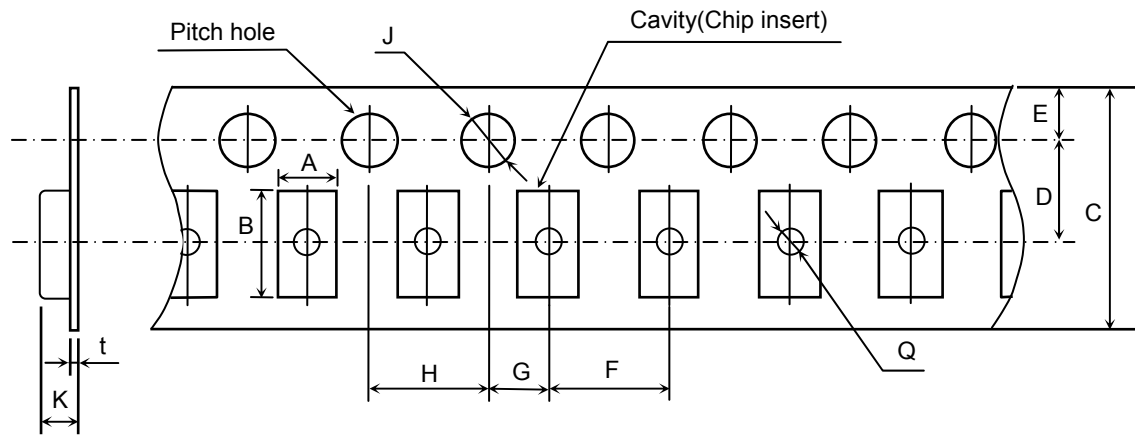

(Unit : mm)

Symbol Type	A	B	C	D	E	F
CGA4 (CC0805)	(1.50)	(2.30)	8.00 ± 0.30	3.50 ± 0.05	1.75 ± 0.10	4.00 ± 0.10
CGA5 (CC1206)	(1.90)	(3.50)				
CGA6 (CC1210)	(2.90)	(3.60)				
			* 12.00 ± 0.30	* 5.50 ± 0.05		

Symbol Type	G	H	J	K	t	Q
CGA4 (CC0805)	2.00 ± 0.05	4.00 ± 0.10	∅ 1.50 ^{+0.10} ₀	2.50 max.	0.60 max.	∅ 0.50 min.
CGA5 (CC1206)				3.40 max.		
CGA6 (CC1210)						

() Reference value.

Exceptionally no hole in the cavity is applied. Please inquire if hole in cavity is mandatory.

* Applied to thickness, 2.5mm products.

Appendix 6

Plastic Tape

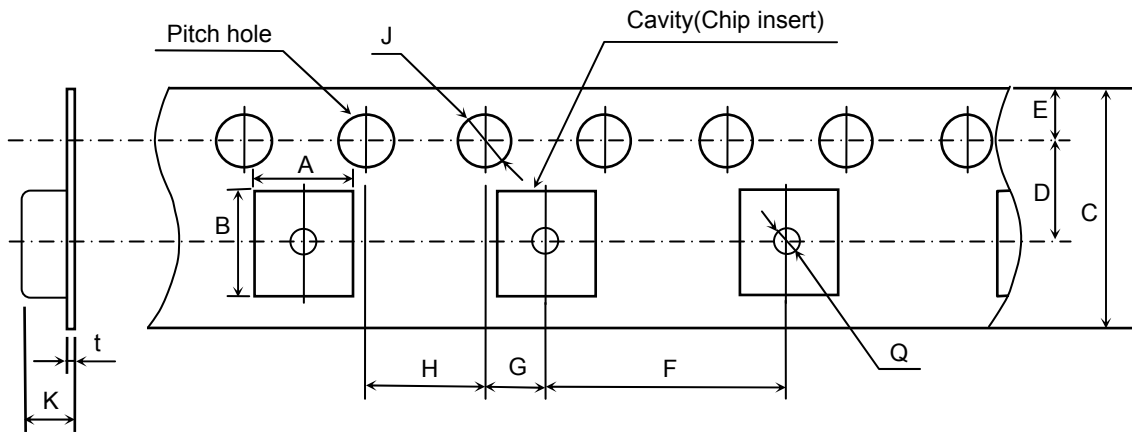

(Unit : mm)

Symbol Type	A	B	C	D	E	F
CGA8 (CC1812)	(3.60)	(4.90)	12.00 ± 0.30	5.50 ± 0.05	1.75 ± 0.10	8.00 ± 0.10
CGA9 (CC2220)	(5.40)	(6.10)				
Symbol Type	G	H	J	K	t	Q
CGA8 (CC1812)	2.00 ± 0.05	4.00 ± 0.10	∅ 1.50 $\begin{smallmatrix} +0.10 \\ 0 \end{smallmatrix}$	6.50 max.	0.60 max.	∅ 1.50 min.
CGA9 (CC2220)						

() Reference value.

Appendix 7

CGA2, CGA3, CGA4, CGA5, CGA6
 (As for CGA6 type, any thickness of the item except 2.5mm)
 (Material : Polystyrene)

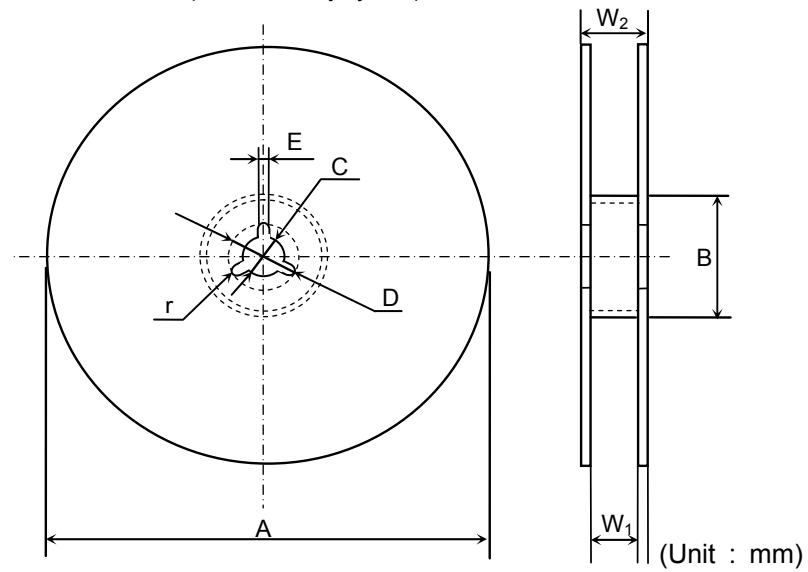

Symbol	A	B	C	D	E	W ₁
Dimension	Ø178 ± 2.0	Ø60 ± 2.0	Ø13 ± 0.5	Ø21 ± 0.8	2.0 ± 0.5	9.0 ± 0.3
Symbol	W ₂	r				
Dimension	13.0 ± 1.4	1.0				

Appendix 8

CGA6, CGA8, CGA9 (As for CGA6 type, applied to 2.5mm thickness products)
 (Material : Polystyrene)

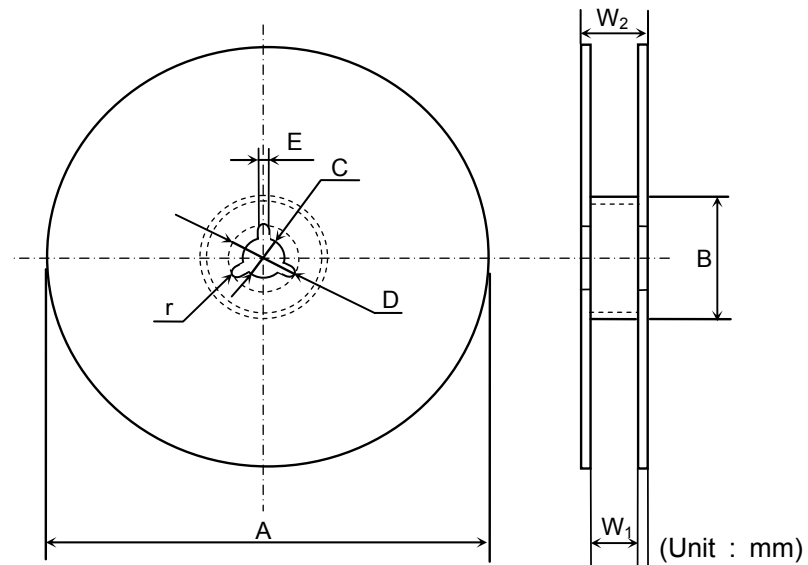

Symbol	A	B	C	D	E	W ₁
Dimension	Ø178 ± 2.0	Ø60 ± 2.0	Ø13 ± 0.5	Ø21 ± 0.8	2.0 ± 0.5	13.0 ± 0.3
Symbol	W ₂	r				
Dimension	17.0 ± 1.4	1.0				

Appendix 9

CGA2, CGA3, CGA4, CGA5, CGA6
 (As for CGA6 type, any thickness of the item except 2.5mm)
 (Material : Polystyrene)

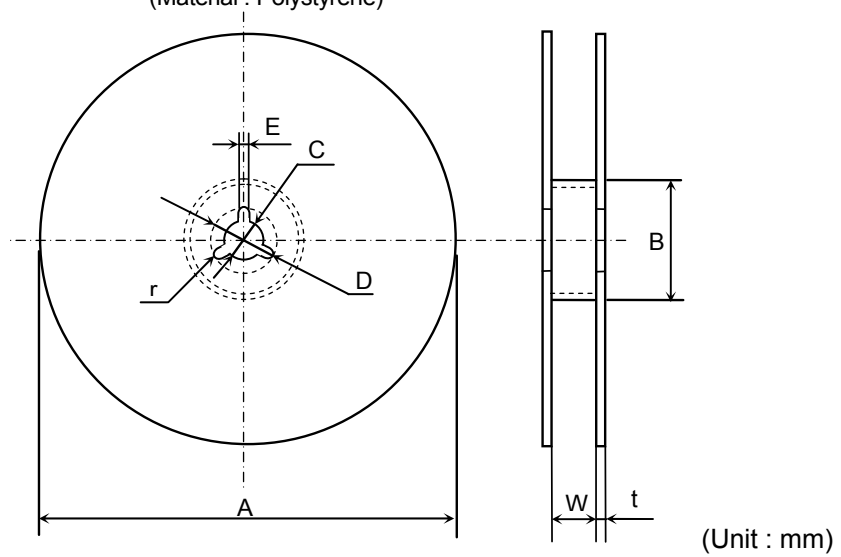

Symbol	A	B	C	D	E	W
Dimension	Ø382 max. (Nominal Ø330)	Ø50 min.	Ø13 ± 0.5	Ø21 ± 0.8	2.0 ± 0.5	10.0 ± 1.5

Symbol	t	r
Dimension	2.0 ± 0.5	1.0

Appendix 10

CGA6, CGA8, CGA9 (As for CGA6 type, applied to 2.5mm thickness products)
 (Material : Polystyrene)

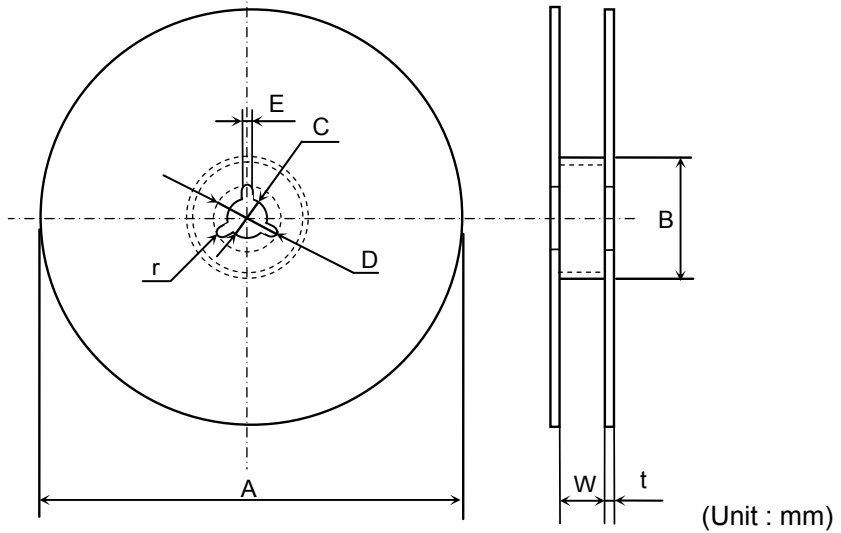

Symbol	A	B	C	D	E	W
Dimension	Ø382 max. (Nominal Ø330)	Ø50 min.	Ø13 ± 0.5	Ø21 ± 0.8	2.0 ± 0.5	14.0 ± 1.5

Symbol	t	r
Dimension	2.0 ± 0.5	1.0

X-ON Electronics

Largest Supplier of Electrical and Electronic Components

Click to view similar products for [Multilayer Ceramic Capacitors MLCC - SMD/SMT category](#):

Click to view products by [TDK manufacturer](#):

Other Similar products are found below :

[M39014/01-1467](#) [M39014/02-1218V](#) [M39014/02-1225V](#) [M39014/02-1262V](#) [M39014/02-1301](#) [M39014/22-0631](#) [1210J5000102JCT](#)
[1210J2K00102KXT](#) [1210J5000103KXT](#) [1210J5000223KXT](#) [D55342E07B379BR-TR](#) [D55342E07B523DR-T/R](#) [1812J1K00103KXT](#)
[1812J1K00473KXT](#) [1812J2K00680JCT](#) [1812J4K00102MXT](#) [1812J5000102JCT](#) [1812J5000103JCT](#) [1812J5000682JCT](#) [NIN-FB391JTRF](#)
[NIN-FC2R7JTRF](#) [NPIS27H102MTRF](#) [C1206C101J1GAC](#) [C1608C0G1E472JT000N](#) [C2012C0G2A472J](#) [2220J2K00101JCT](#)
[KHC201E225M76N0T00](#) [LRC-LRF1206LF-01R025FTR1K](#) [1812J1K00222JCT](#) [1812J2K00102KXT](#) [1812J2K00222KXT](#)
[1812J2K00472KXT](#) [2-1622820-7-CUT-TAPE](#) [2220J3K00102KXT](#) [2225J2500824KXT](#) [CCR07CG103KM](#) [CGA2B2C0G1H010C](#)
[CGA2B2C0G1H040C](#) [CGA2B2C0G1H050C](#) [CGA2B2C0G1H060D](#) [CGA2B2C0G1H070D](#) [CGA2B2C0G1H151J](#) [CGA2B2C0G1H1R5C](#)
[CGA2B2C0G1H2R2C](#) [CGA2B2C0G1H3R3C](#) [CGA2B2C0G1H680J](#) [CGA2B2C0G1H6R8D](#) [CGA2B2X8R1H221K](#) [CGA2B2X8R1H472K](#)
[CGA3E1X7R1C474K](#)