

- SPECIFICATIONS:
- INSULATION RESISTANCE: VOLTAGE OF 500V D.C. SHALL BE APPLIED TO THE TERMINALS. AFTER WHICH MEASUREMENT SHALL BE MADE A GAUGE FOR THE MEASUREMENT SHALL BE USED THE INSULATION GAUGE.
 - CONTACT RESISTANCE: 30mΩ OR LESS
 - VOLTAGE PROOF: 500V AC FOR ONE MINUTE
 - DURABILITY: 5,000 INSERTION/REMOVAL CYCLES (MINIMUM)
 - INSERTION FORCE: 0.6KGF~2.0KGF
 - WITHDRAWAL FORCE: 0.6KGF~2.0KGF
 - WATER PROOFNESS: This product is based on IPX5/7 of the JIS Standard
 - USING PLUG: 43.5MM, 4-POLE STEREO EARPHONE (LCH/RCH/GND/MIC) PROVIDED THAT THEY CONFORM TO JIS C6560
 - HOUSING STRENGTH IS 50N MAX

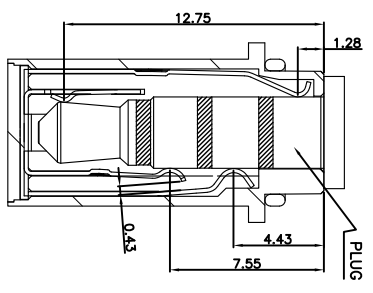
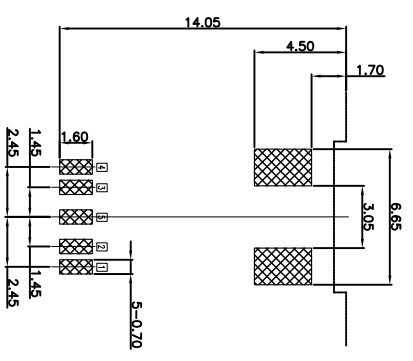
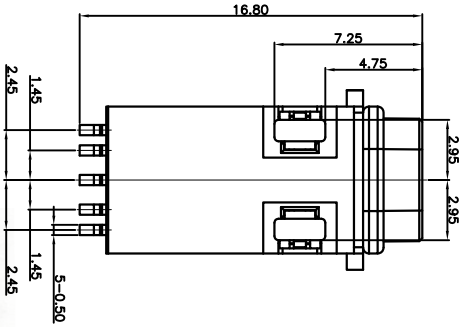
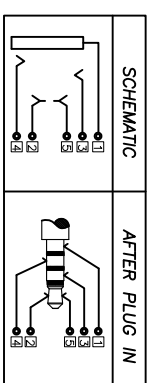
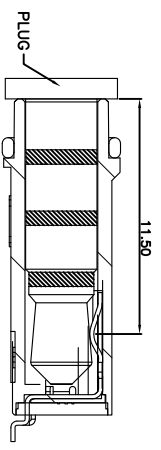
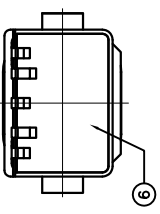
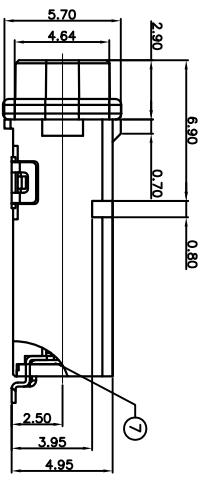
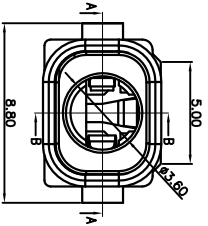

SECA-A
Image of plug match with contact point

Recommended PCB Layout

For and on behalf of
XKB INDUSTRIAL PRECISION CO., LIMITED
香港星坤工業精密有限公司

MARK	DESCRIPTION	DATE	REVISED	APPROVED	UNSPECIFIED TOLERANCES
△X					ANGULAR ±5°
△X					L ≤ 4 ±0.2
△X					4 < L ≤ 16 ±0.3
△X					16 < L ≤ 63 ±0.4
					L > 63 ±0.5

DSND	DATE	SCALE:	MODEL TYPE:
DWN	DATE	N/A	3.5 PHONE JACK
CHKD	DATE		
APPD	DATE		

NO.	DESCRIPTION	TEMP	PLATING
10	Oval ring		
9	BOND		
8	TERMINAL		AU PLATED
7	COVER	HIGH TEMP	UL 94V-0
6	HOUSING	HIGH TEMP	UL 94V-0
5	TERMINAL 5	COPPER ALLOY	AU PLATED
4	TERMINAL 4	COPPER ALLOY	AU PLATED
3	TERMINAL 3	COPPER ALLOY	AU PLATED
2	TERMINAL 2	COPPER ALLOY	AU PLATED
1	TERMINAL 1	COPPER ALLOY	AU PLATED

THIS DOCUMENT IS THE PROPERTY OF CHUNSHENG ELECTRONICS CO., LTD. NO PART THEREOF MAY BE REPRODUCED AND USED WITHOUT THE PRIOR WRITTEN CONSENT OF THE OWNER

REVISIONS
Revised Signature(s)

NO.	DESCRIPTION	DATE	REVISED	APPROVED	UNSPECIFIED TOLERANCES
1					

XKB INDUSTRIAL PRECISION CO., LIMITED

DSND	DATE	SCALE:	MODEL TYPE:
DWN	DATE	N/A	3.5 PHONE JACK
CHKD	DATE		
APPD	DATE		

PART NO.: P.J-3255
 DWG NO.: P.J-3255
 WEIGHT: 1.0g
 SHEET: 1/1
 REVISION: A0

X-ON Electronics

Largest Supplier of Electrical and Electronic Components

Click to view similar products for [DIN Connectors](#) category:

Click to view products by [XKB](#) manufacturer:

Other Similar products are found below :

[60KD4M](#) [12DL6MX](#) [12JL6M](#) [164-183](#) [17DN100-EX](#) [17DN101-EX](#) [SMD7FRA011](#) [16PJ224-E](#) [171-0278](#) [17PP048-EX](#) [M55116/1-2](#)
[KQLAX-8P](#) [M55116/10-0](#) [SMD5FRA021](#) [15AN84X](#) [13AL6FX](#) [61GA5F](#) [152-002-2-4](#) [0134 05](#) [MDC-004](#) [MDC-104](#) [MDC-204](#) [MDC-208](#)
[12BPKG](#) [DC-001](#) [DC-007](#) [591-0400](#) [591-0500](#) [DS1093-01-BN40](#) [593-0700](#) [MJ-372-4](#) [MJ-372-6](#) [MJ-372-8](#) [57PC5M](#) [592-0301](#) [592-0511](#)
[164-377](#) [610-0520](#) [0105 05](#) [0105 08](#) [0107 08-1](#) [690-0300](#) [0132 05](#) [930009200 MAB 4](#) [930071200 MAB 5 S](#) [930303517 MAB 3100 S](#)
[GRAU](#) [930345200 MAB 8 S](#) [930356517 MAS 70 S GRAU](#) [930952517 MAB 5100](#) [930954517 MAB 6100 GRAU](#)