

SESOTXXC
Dual Transient Voltage Suppressors Array for ESD Protection

Revision:C

General Description

The SESOTXXC is a dual monolithic voltage suppressor designed to protect components which are connected to data and transmission lines against ESD. It clamps the voltage just above the logic level supply for positive transients and to a diode drop below ground for negative transients. It can also work as bidirectional suppressor by connecting only pin1 and 2.

Applications

- Computers
- Printers
- Communication systems

Features

- 2 Unidirectional Transil functions
- Low leakage current: $I_R \max < 20 \mu A$ at V_{RM}
- 300W peak pulse power(8/20 μs)
- Transient protection for data lines as per

Complies with the following standards

IEC61000-4-2

Level 4 15 kV (air discharge)

8 kV(contact discharge)

MIL STD 883E - Method 3015-7 Class 3

25 kV HBM (Human Body Model)

Functional diagram

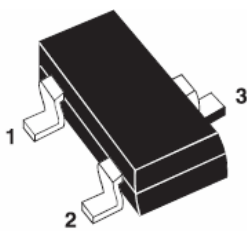

SOT-23

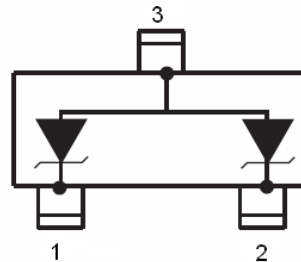

Absolute Ratings ($T_{amb}=25^{\circ}C$)

Symbol	Parameter	Value	Units
P_{PP}	Peak Pulse Power ($t_p = 8/20\mu s$)	350	W
T_L	Maximum lead temperature for soldering during 10s	260	$^{\circ}C$
T_{stg}	Storage Temperature Range	-55 to +155	$^{\circ}C$
T_{op}	Operating Temperature Range	-40 to +125	$^{\circ}C$
T_j	Maximum junction temperature	150	$^{\circ}C$
V_{PP}	Electrostatic discharge		
	IEC61000-4-2 air discharge	15	kV
	IEC61000-4-2 contact discharge	8	

Electrical Parameter

Symbol	Parameter
I_{PP}	Maximum Reverse Peak Pulse Current
V_C	Clamping Voltage @ I_{PP}
V_{RWM}	Working Peak Reverse Voltage
I_R	Maximum Reverse Leakage Current @ V_{RWM}
I_T	Test Current
V_{BR}	Breakdown Voltage @ I_T

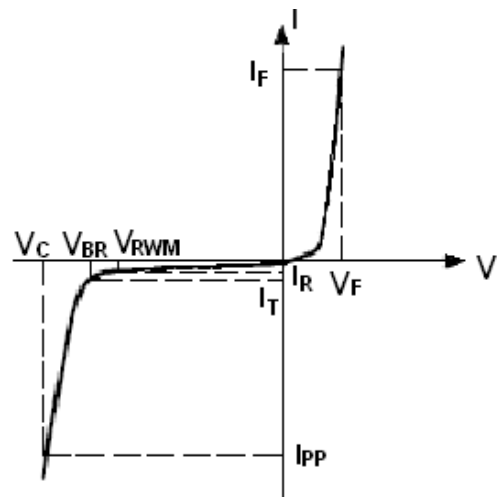

Electrical Characteristics

Part Numbers	V_{BR}			I_T	V_{RWM}	I_R	C
	Min.	Typ.	Max.				Typ. 0v bias
	V	V	V				pF
SESOT04C	5.0	5.6	6.2	1	4.0	1	30
SESOT05C	6.0	6.7	7.4	1	5.0	1	30
SESOT12C	13.3	14.0	14.7	1	12.0	1	25
SESOT15C	16.7	17.4	18.1	1	15.0	1	25
SESOT24C	26.7	28.2	29.6	1	24.0	1	20

1). 8/20 waveform used. (see fig2.)

Typical Characteristics

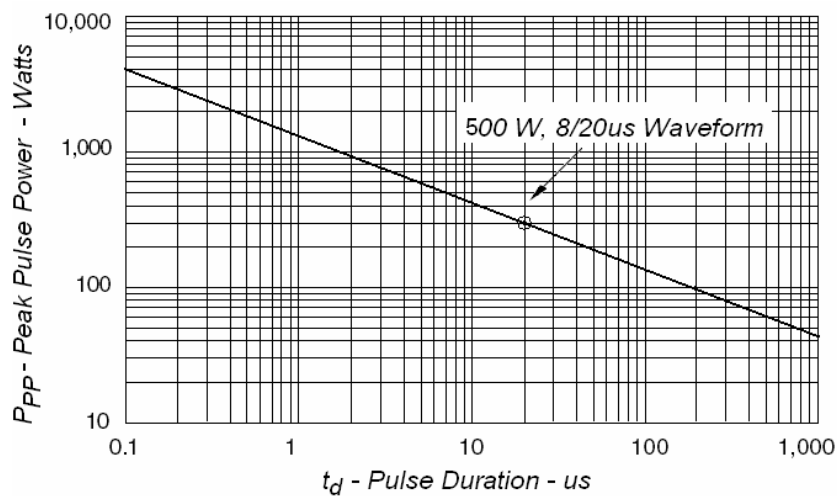

Fig1. Peak Pulse Power VS Pulse Time

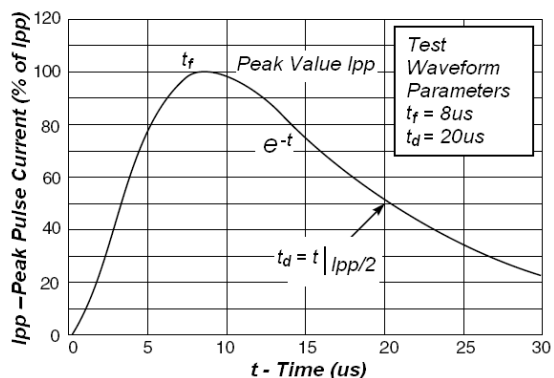

Fig2. Pulse Waveform

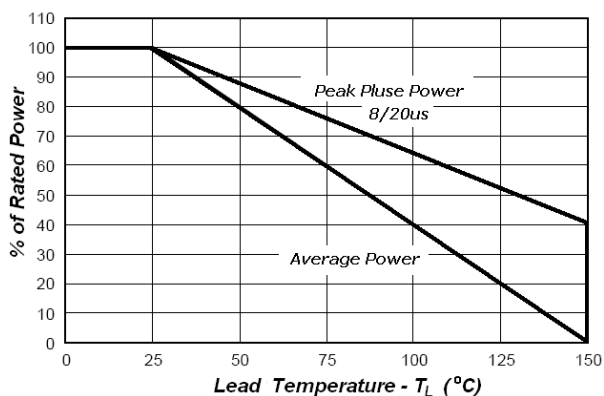

Fig3. Power Derating Curve

Application Note

Electrostatic discharge (ESD) is a major cause of failure in electronic systems. Transient Voltage Suppressors (TVS) are an ideal choice for ESD protection. They are capable of clamping the incoming transient to a low enough level such that damage to the protected semiconductor is prevented.

Surface mount TVS arrays offer the best choice for minimal lead inductance. They serve as parallel protection elements, connected between the signal line to ground. As the transient rises above the operating voltage of the device, the TVS array becomes a low impedance path diverting the transient current to ground. The SESOTxxC array is the ideal board level protection of ESD sensitive semiconductor components.

The tiny SOT-23 package allows design flexibility in the design of high density boards where the space saving is at a premium. This enables to shorten the routing and contributes to hardening against ESD.

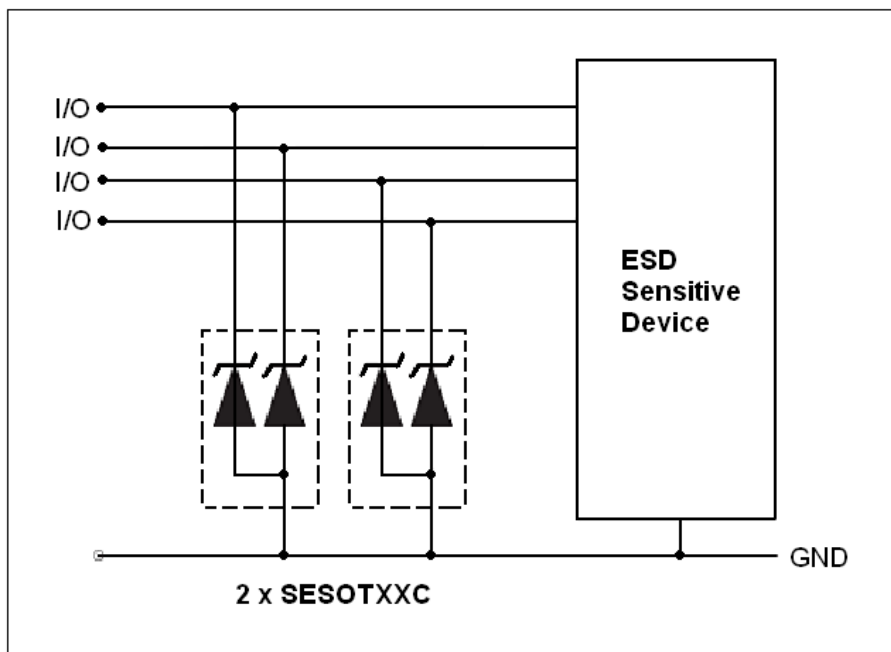

SOT-23 mechanical data

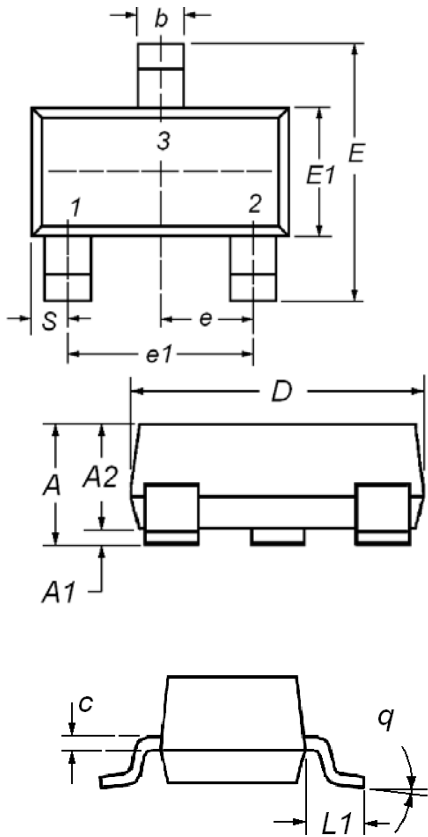

Dim	Millimeters		
	Min	TYP	Max
A	1.00	1.20	1.40
A1	0	0.05	0.10
A2	1.00	1.15	1.30
b	0.35	0.40	0.50
c	0.10	0.15	0.20
D	2.70	2.90	3.10
E	2.40	2.60	2.80
E1	1.40	1.50	1.60
e	0.85	1.00	1.15
e1	1.80	1.90	2.00
L1	0.40	.	
q	0°	5°	10°
S	0.45	0.50	0.55

The SINO-IC logo is a registered trademark of ShangHai Sino-IC Microelectronics Co., Ltd.

© 2005 SINO-IC – Printed in China – All rights reserved.

SHANGHAI SINO-IC MICROELECTRONICS CO., LTD

Add: Building 3, Room 3401-03, No.200 Zhangheng Road, ZhangJiang Hi-Tech Park, Pudong, Shanghai 201203, China

Phone: +86-21-33932402 33932403 33932405 33933508 33933608

Fax: +86-21-33932401

Email: webmaster@sino-ic.com

Website: <http://www.sino-ic.com>

X-ON Electronics

Largest Supplier of Electrical and Electronic Components

Click to view similar products for [ESD Suppressors / TVS Diodes category](#):

Click to view products by [SINO-IC manufacturer](#):

Other Similar products are found below :

[NTE4902](#) [P4SMAJ15A](#) [P4SMAJ26A](#) [SMAJ400CA-TP](#) [TGL34-47CA](#) [ESDAULC45-1BF4](#) [SM1605E3/TR13](#) [SMF20A-TP](#) [P4SMAJ12A](#)
[CPDUR24V-HF](#) [CPDQC5V0USP-HF](#) [CPDQC5V0-HF](#) [MPLAD30KP45CAE3](#) [MMBZ27VCLQ-7-F](#) [MMAD1108/TR13](#) [MPLAD30KP24A](#)
[ACPDQC5V0R-HF](#) [DFLT170A-7](#) [NTE4900](#) [NTE4926](#) [NTE4938](#) [SMF22A-TP](#) [SMF12A-TP](#) [SLVU2.8-TP](#) [SMLJ6.5CA-TP](#) [SMAJ6.5CA-](#)
[TP](#) [MMAD1108E3/TR13](#) [D5V0M1U2LP3-7](#) [SMAJ400A-TP](#) [AOZ8811DT-03](#) [AOZ8831DI-05](#) [AOZ8831DT-03](#) [SMAJ188CA](#) [3SMC33CA](#)
[BK](#) [CPDQC3V3C-HF](#) [CPDQC12VE-HF](#) [MPLAD30KP170CA](#) [82357120100](#) [5.0SMLJ15CA-TP](#) [5KP18A-TP](#) [P6KE8.2A-TP](#)
[MPLAD30KP43CAE3](#) [SMAJ43A-TP](#) [D5V0F6U8LP33-7](#) [TVS5501V10MUT5G](#) [5.0SMLJ24CA-TP](#) [SMAJ110CA-TP](#) [MPLAD15KP75CAE3](#)
[MMAD1103e3/TR13](#) [DFLT40AQ-7](#)