

LW10252-\*\*\*  
 NO OF CKT (产品PIN数)  
 0: 端子全零锡  
 1: 端子全金 (G/F OVERALL)  
 2: 端子半金锡  
 R: TAPE & REEL 卷装  
 T: TUBE 管装  
 Packing (包装方式)

6. 产品料号:  
 5. 绝缘电阻:  $\geq 500M\Omega$   
 4. 接触电阻:  $\leq 0.03\Omega$   
 3. 额定电压: 50V, AC/DC (等效).  
 2. 温度范围:  $-25^{\circ}C \sim 85^{\circ}C$ .  
 1. 塑料表面应光洁、无毛边、无明显收缩、缺陷、裂纹等现象。

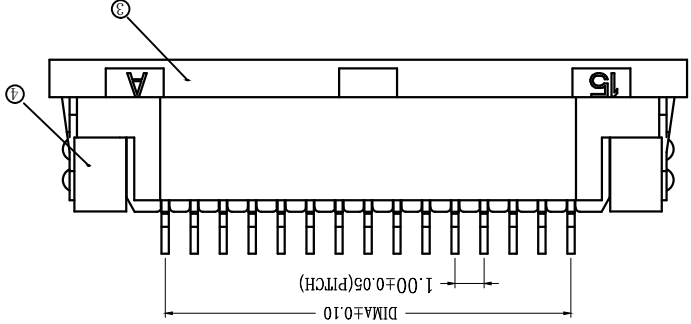

通用扁平线

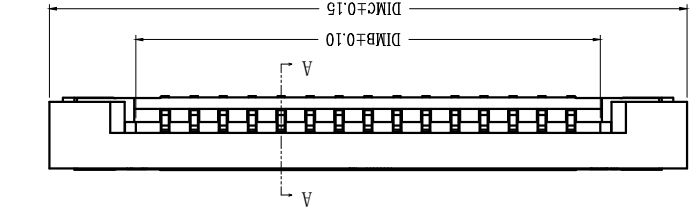
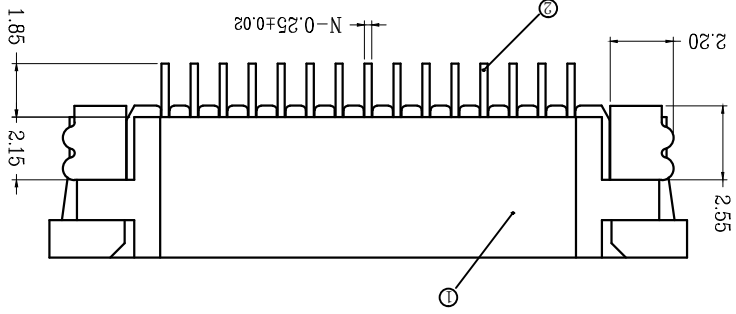
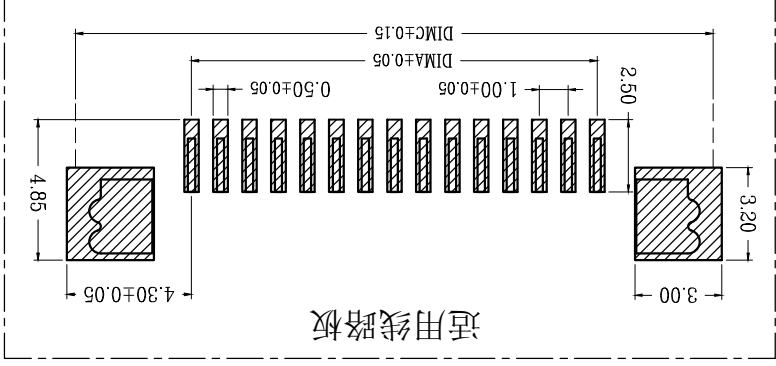
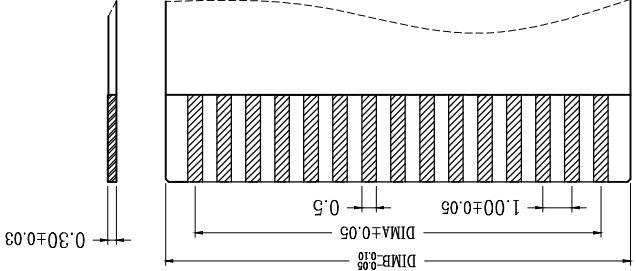

适用线路板

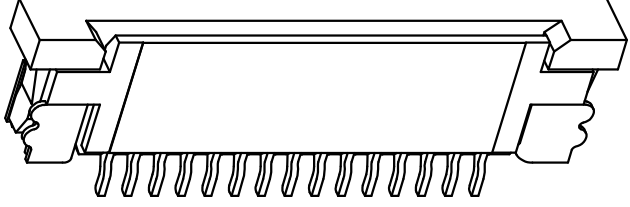
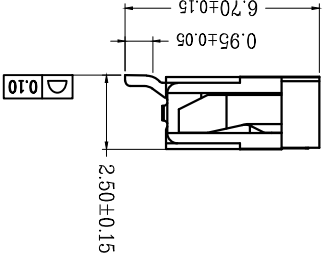
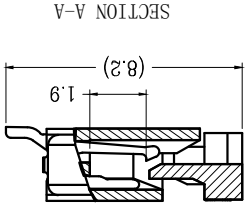

比例 (SCALE)	1:1	单位 (UNITS)	mm
料号 (DRAW.NO)	LW10252-***		
品名 (ITEM)	1.0 Pitch K型卧式下接(H=2.5)		
制图 (DR)	TONY	校对 (CHKD)	SUNNY
审核 (APP)	JTM	张数 (SHEET)	1 OF 1
尺寸 (SIZE)	A4	REV	A

MINTRON TECHNOLOGY CO., LTD.

CKT	DIM A	DIM B	DIM C
40	39.00	41.03	47.00
39	38.00	40.03	46.00
38	37.00	39.03	45.00
37	36.00	38.03	44.00
36	35.00	37.03	43.00
35	34.00	36.03	42.00
34	33.00	35.03	41.00
33	32.00	34.03	40.00
32	31.00	33.03	39.00
31	30.00	32.03	38.00
30	29.00	31.03	37.00
29	28.00	30.03	36.00
28	27.00	29.03	35.00
27	26.00	28.03	34.00
26	25.00	27.03	33.00
25	24.00	26.03	32.00
24	23.00	25.03	31.00
23	22.00	24.03	30.00
22	21.00	23.03	29.00
21	20.00	22.03	28.00
20	19.00	21.03	27.00
19	18.00	20.03	26.00
18	17.00	19.03	25.00
17	16.00	18.03	24.00
16	15.00	17.03	23.00
15	14.00	16.03	22.00
14	13.00	15.03	21.00
13	12.00	14.03	20.00
12	11.00	13.03	19.00
11	10.00	12.03	18.00
10	9.00	11.03	17.00
9	8.00	10.03	16.00
8	7.00	9.03	15.00
7	6.00	8.03	14.00
6	5.00	7.03	13.00
5	4.00	6.03	12.00
4	3.00	5.03	11.00

序号	品名	材质
①	1.0K型胶芯	LCP UL94V-0 本色
②	1.0K型下接端子	磷青铜/表面镀锡
③	1.0K型卧式后盖	LCP UL94V-0 黑色
④	1.0K型卧式薄片	黄铜/表面镀锡

版次	1
变更摘要	增加料号说明
日期	2018/1/28

## X-ON Electronics

Largest Supplier of Electrical and Electronic Components

*Click to view similar products for [FFC & FPC Connectors](#) category:*

*Click to view products by [MINTRON](#) manufacturer:*

Other Similar products are found below :

[HFW11R-1STE1H1LF](#) [FH29B-100S-0.2SHW\(99\)](#) [FA5S008HP1](#) [FH29B-120S-0.2SHW\(99\)](#) [FH29B-80S-0.2SHW\(99\)](#) [FHS-16](#) [FPH-2022G](#)  
[52610-1075](#) [52610-1275](#) [52610-1934](#) [XF3M\(1\)-1415-1B-R100](#) [501864-3091-TR225](#) [0525594033](#) [086210010340800](#) [086222026001800](#)  
[52271-2869-CUT-TAPE](#) [62674-201121DLF](#) [62684-36210E9ALF](#) [52610-1675](#) [52746-1671-TR250](#) [10051922-2810EHLF](#) [6-520415-9](#)  
[BD021-09A-A1-0350-0200-0550-LD](#) [SFV6R-1STE9HLF](#) [XF3M-2915-1B-R100](#) [1658549-1](#) [62674-221121ALF](#) [46214008010800](#)  
[046298003000883](#) [151660622](#) [842-816-2630-035](#) [AYF530665TA](#) [AYF351525](#) [046296011930846+](#) [AYF352325A](#) [046254020000800+](#)  
[FH19C-13S-0.5SH\(99\)](#) [FH39J-51S-0.3SHW\(99\)](#) [AYF355125A](#) [AYF530365TA](#) [FH29B-44S-0.2SHW\(99\)](#) [SFW5R-2STAE9LF](#) [AYF351125A](#)  
[AYF350725A](#) [62684-502100AHLF](#) [FH39-61S-0.3SHW\(99\)](#) [AYF414035A](#) [10064555-172520HLF](#) [AYF212335A](#) [504754-2500](#)