

技术指标:

1. 塑件表面应光洁、无毛边、无明显收缩、缺陷、裂纹等现象。
2. 温度范围: -25°C~85°C。
3. 额定电压: 50V, AC/DC(等效)。
4. 接触电阻:  $\leq 0.03\Omega$ 。
5. 绝缘电阻:  $\geq 500M\Omega$ 。
6. 产品料号:

NO OF CKT (产品PIN数)  
 XW05200-\*\*\*  
 0: 端子全雾锡  
 1: 端子全金(G/F OVERALL)  
 2: 端子半金锡  
 R: TAPE & REEL 卷装  
 T: TUBE管装  
 Packing (包装方式)

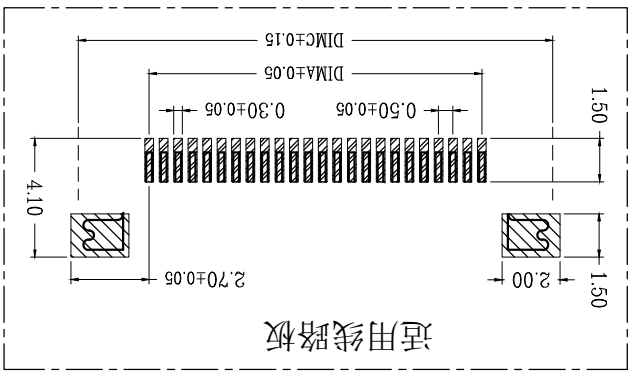
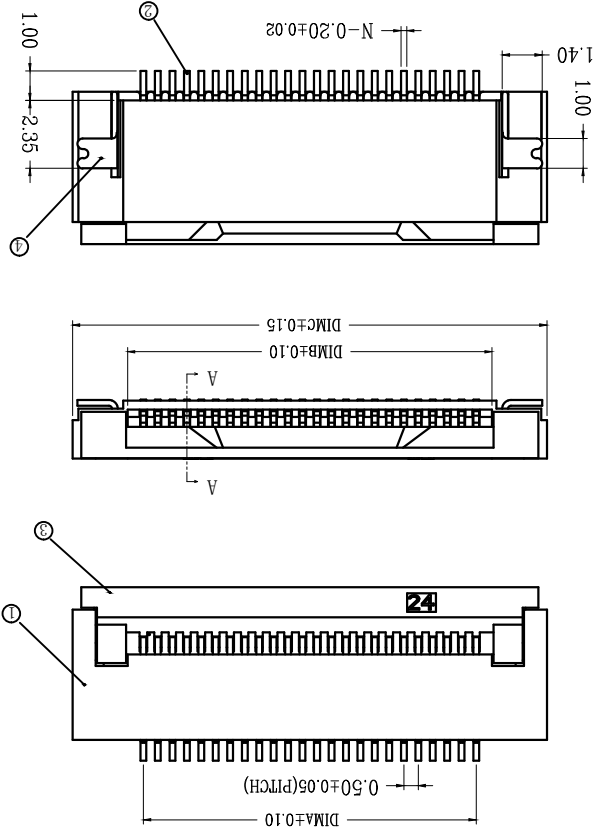

通用扁平线

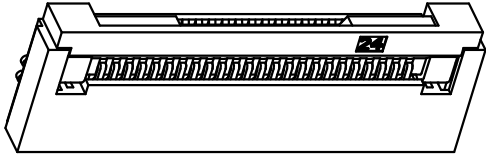
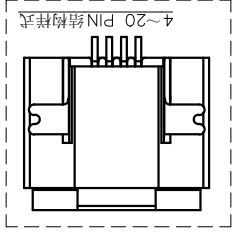
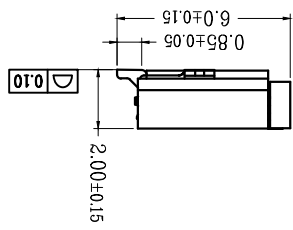
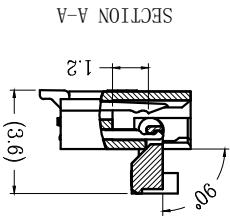
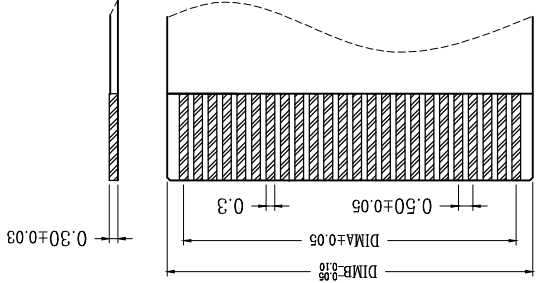

1 版次

变更摘要

2015/1/28 日期

序号

品名

材质

①	0.5 掀盖胶芯 (H2.0)	LCP UL94V-0 本色
②	0.5 掀盖端子 (H2.0)	磷青铜/表面镀锡
③	0.5 掀盖后盖 (H2.0)	LCP UL94V-0 黑色
④	0.5 掀盖焊片 (H2.0)	黄铜/表面镀锡

CKT	DIMA	DIMB	DIMC
4	1.50	2.60	6.40
5	2.00	3.10	6.90
6	2.50	3.60	7.40
7	3.00	4.10	7.90
8	3.50	4.60	8.40
9	4.00	5.10	8.90
10	4.50	5.60	9.40
11	5.00	6.10	9.90
12	5.50	6.60	10.40
13	6.00	7.10	10.90
14	6.50	7.60	11.40
15	7.00	8.10	11.90
16	7.50	8.60	12.40
17	8.00	9.10	12.90
18	8.50	9.60	13.40
19	9.00	10.10	13.90
20	9.50	10.60	14.40
21	10.00	11.10	14.90
22	10.50	11.60	15.40
23	11.00	12.10	15.90
24	11.50	12.60	16.40
25	12.00	13.10	16.90
26	12.50	13.60	17.40
27	13.00	14.10	17.90
28	13.50	14.60	18.40
29	14.00	15.10	18.90
30	14.50	15.60	19.40
31	15.00	16.10	19.90
32	15.50	16.60	20.40

CKT	DIMA	DIMB	DIMC
33	16.00	17.10	20.90
34	16.50	17.60	21.40
35	17.00	18.10	21.90
36	17.50	18.60	22.40
37	18.00	19.10	22.90
38	18.50	19.60	23.40
39	19.00	20.10	23.90
40	19.50	20.60	24.40
41	20.00	21.10	24.90
42	20.50	21.60	25.40
43	21.00	22.10	25.90
44	21.50	22.60	26.40
45	22.00	23.10	26.90
46	22.50	23.60	27.40
47	23.00	24.10	27.90
48	23.50	24.60	28.40
49	24.00	25.10	28.90
50	24.50	25.60	29.40
51	25.00	26.10	29.90
52	25.50	26.60	30.40
53	26.00	27.10	30.90
54	26.50	27.60	31.40
55	27.00	28.10	31.90
56	27.50	28.60	32.40
57	28.00	29.10	32.90
58	28.50	29.60	33.40
59	29.00	30.10	33.90
60	29.50	30.60	34.40

制图 (DR)	TONY
校对 (CHKD)	SUNNY
审核 (APP)	JTM
料号 (DWG.NO)	XW05200-***
品名 (TITLE)	0.5 Pitch掀盖卧式下接(H=2.0)
比例 (SCALE)	1:1
单位 (UNITS)	mm
张数 (SHEET)	1 OF 1
尺寸 (SIZE)	A4
图例 (REV)	A

MINTRON TECHNOLOGY CO., LTD.

一般公差 (TOLERANCE)  
 X ± 0.10  
 XX ± 0.05  
 XXX ± 0.02  
 ANGLES 31°

## X-ON Electronics

Largest Supplier of Electrical and Electronic Components

*Click to view similar products for [FFC & FPC Connectors](#) category:*

*Click to view products by [MINTRON](#) manufacturer:*

Other Similar products are found below :

[HFW11R-1STE1H1LF](#) [FH29B-100S-0.2SHW\(99\)](#) [FA5S008HP1](#) [FH29B-120S-0.2SHW\(99\)](#) [FH29B-80S-0.2SHW\(99\)](#) [FHS-16](#) [FPH-2022G](#)  
[52610-1075](#) [52610-1275](#) [52610-1934](#) [XF3M\(1\)-1415-1B-R100](#) [501864-3091-TR225](#) [0525594033](#) [086210010340800](#) [086222026001800](#)  
[52271-2869-CUT-TAPE](#) [62674-201121DLF](#) [62684-36210E9ALF](#) [52610-1675](#) [52746-1671-TR250](#) [10051922-2810EHLF](#) [6-520415-9](#)  
[BD021-09A-A1-0350-0200-0550-LD](#) [SFV6R-1STE9HLF](#) [XF3M-2915-1B-R100](#) [1658549-1](#) [62674-221121ALF](#) [46214008010800](#)  
[046298003000883](#) [151660622](#) [842-816-2630-035](#) [AYF530665TA](#) [AYF351525](#) [046296011930846+](#) [AYF352325A](#) [046254020000800+](#)  
[FH19C-13S-0.5SH\(99\)](#) [FH39J-51S-0.3SHW\(99\)](#) [AYF355125A](#) [AYF530365TA](#) [FH29B-44S-0.2SHW\(99\)](#) [SFW5R-2STAE9LF](#) [AYF351125A](#)  
[AYF350725A](#) [62684-502100AHLF](#) [FH39-61S-0.3SHW\(99\)](#) [AYF414035A](#) [10064555-172520HLF](#) [AYF212335A](#) [504754-2500](#)