

技术指标:

1. 塑件表面应光洁、无毛边、无明显收缩、缺陷、裂纹等现象。
2. 温度范围: -25°C~85°C。
3. 额定电压: 50V, AC/DC(等效)。
4. 接触电阻: $\leq 0.03\Omega$ 。
5. 绝缘电阻: $\geq 500M\Omega$ 。
6. 产品料号:

NO OF CKT (产品PIN数)
 XW05200-***
 0: 端子全雾锡
 1: 端子全金(G/F OVERALL)
 2: 端子半金锡
 R: TAPE & REEL 卷装
 T: TUBE管装
 Packing (包装方式)

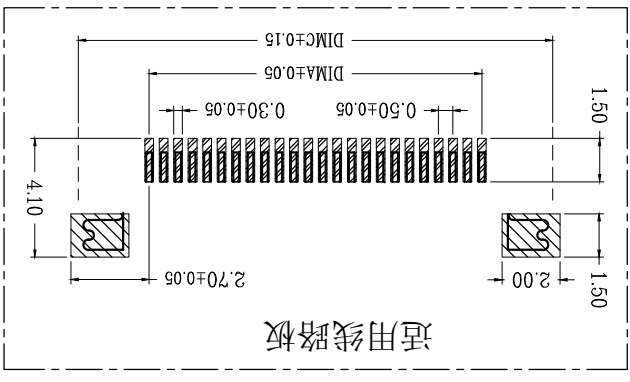
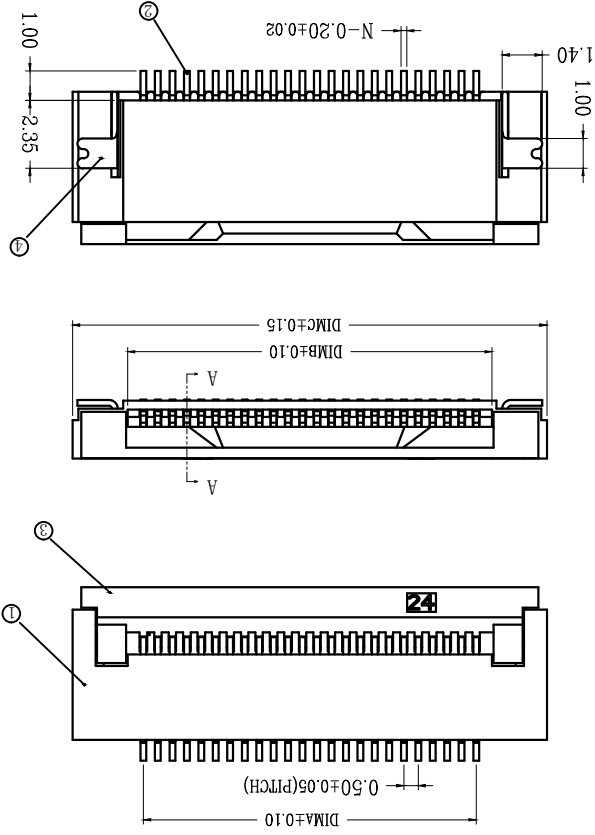

通用扁平线

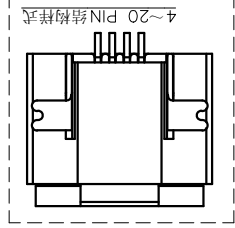
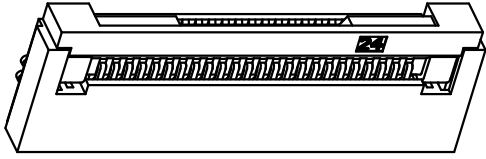
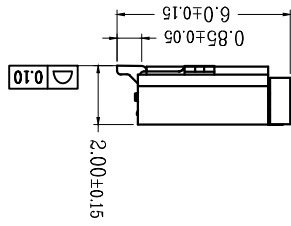
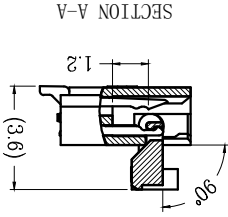
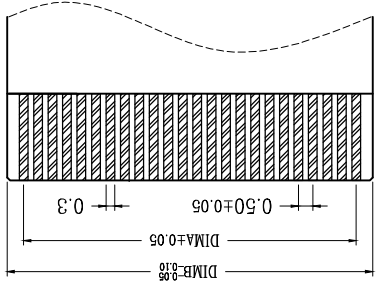

比例 (SCALE)	1:1	单位 (UNITS)	mm
料号 (DWG.NO)	XW05200-***		
校对 (CHKD)	SUNNY		
制图 (DR)	TONY		
品名 (TITLE)	0.5 Pitch 掀盖卧式下接(H=2.0)		
料号 (DWG.NO)	XW05200-***		
审核 (APP)	JTM		
张数 (SHEET)	1 OF 1		
尺寸 (SIZE)	A4		
版本 (REV)	A		

32	15.50	16.60	20.40
31	15.00	16.10	19.90
30	14.50	15.60	19.40
29	14.00	15.10	18.90
28	13.50	14.60	18.40
27	13.00	14.10	17.90
26	12.50	13.60	17.40
25	12.00	13.10	16.90
24	11.50	12.60	16.40
23	11.00	12.10	15.90
22	10.50	11.60	15.40
21	10.00	11.10	14.90
20	9.50	10.60	14.40
19	9.00	10.10	13.90
18	8.50	9.60	13.40
17	8.00	9.10	12.90
16	7.50	8.60	12.40
15	7.00	8.10	11.90
14	6.50	7.60	11.40
13	6.00	7.10	10.90
12	5.50	6.60	10.40
11	5.00	6.10	9.90
10	4.50	5.60	9.40
9	4.00	5.10	8.90
8	3.50	4.60	8.40
7	3.00	4.10	7.90
6	2.50	3.60	7.40
5	2.00	3.10	6.90
4	1.50	2.60	6.40
3	1.00	2.10	5.90
2	0.50	1.60	5.40
1	0.00	1.10	4.90
0	0.00	0.60	4.40
39	19.00	20.10	23.90
38	18.50	19.60	23.40
37	18.00	19.10	22.90
36	17.50	18.60	22.40
35	17.00	18.10	21.90
34	16.50	17.60	21.40
33	16.00	17.10	20.90
32	15.50	16.60	20.40
31	15.00	16.10	19.90
30	14.50	15.60	19.40
29	14.00	15.10	18.90
28	13.50	14.60	18.40
27	13.00	14.10	17.90
26	12.50	13.60	17.40
25	12.00	13.10	16.90
24	11.50	12.60	16.40
23	11.00	12.10	15.90
22	10.50	11.60	15.40
21	10.00	11.10	14.90
20	9.50	10.60	14.40
19	9.00	10.10	13.90
18	8.50	9.60	13.40
17	8.00	9.10	12.90
16	7.50	8.60	12.40
15	7.00	8.10	11.90
14	6.50	7.60	11.40
13	6.00	7.10	10.90
12	5.50	6.60	10.40
11	5.00	6.10	9.90
10	4.50	5.60	9.40
9	4.00	5.10	8.90
8	3.50	4.60	8.40
7	3.00	4.10	7.90
6	2.50	3.60	7.40
5	2.00	3.10	6.90
4	1.50	2.60	6.40
3	1.00	2.10	5.90
2	0.50	1.60	5.40
1	0.00	1.10	4.90
0	0.00	0.60	4.40

1	变更摘要	2015/1/28	序号	品名	材质
①	增加料号说明		1	0.5掀盖胶芯	LCP UL94V-0 本色
②			2	0.5掀盖端子	磷青铜/表面镀锡
③			3	0.5掀盖后盖	LCP UL94V-0 黑色
④			4	0.5掀盖焊片	黄铜/表面镀锡

X-ON Electronics

Largest Supplier of Electrical and Electronic Components

Click to view similar products for [FFC & FPC Connectors](#) category:

Click to view products by [MINTRON](#) manufacturer:

Other Similar products are found below :

[HFW11R-1STE1H1LF](#) [FH29B-100S-0.2SHW\(99\)](#) [FA5S008HP1](#) [FH29B-120S-0.2SHW\(99\)](#) [FH29B-80S-0.2SHW\(99\)](#) [FHS-16](#) [FPH-2022G](#)
[52610-1075](#) [52610-1275](#) [52610-1934](#) [XF3M\(1\)-1415-1B-R100](#) [501864-3091-TR225](#) [0525594033](#) [086210010340800](#) [086222026001800](#)
[52271-2869-CUT-TAPE](#) [62674-201121DLF](#) [62684-36210E9ALF](#) [52610-1675](#) [52746-1671-TR250](#) [10051922-2810EHLF](#) [6-520415-9](#)
[BD021-09A-A1-0350-0200-0550-LD](#) [SFV6R-1STE9HLF](#) [XF3M-2915-1B-R100](#) [1658549-1](#) [62674-221121ALF](#) [46214008010800](#)
[046298003000883](#) [151660622](#) [842-816-2630-035](#) [AYF530665TA](#) [AYF351525](#) [046296011930846+](#) [AYF352325A](#) [046254020000800+](#)
[FH19C-13S-0.5SH\(99\)](#) [FH39J-51S-0.3SHW\(99\)](#) [AYF355125A](#) [AYF530365TA](#) [FH29B-44S-0.2SHW\(99\)](#) [SFW5R-2STAE9LF](#) [AYF351125A](#)
[AYF350725A](#) [62684-502100AHLF](#) [FH39-61S-0.3SHW\(99\)](#) [AYF414035A](#) [10064555-172520HLF](#) [AYF212335A](#) [504754-2500](#)