



TSP5N65M/TSF5N65M

650V N-Channel MOSFET

General Description

This Power MOSFET is produced using Truesemi's advanced planar stripe DMOS technology. This advanced technology has been especially tailored to minimize on-state resistance, provide superior switching performance, and withstand high energy pulse in the avalanche and commutation mode. These devices are well suited for high efficiency switched mode power supplies, active power factor correction based on half bridge topology.

Features

- 4.5A,650V,Max. $R_{DS(on)}=3.0\ \Omega$ @ $V_{GS}=10V$
- Low gate charge(typical 16nC)
- High ruggedness
- Fast switching
- 100% avalanche tested
- Improved dv/dt capability

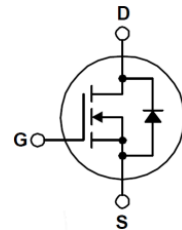
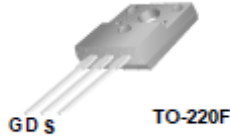
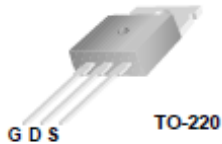

Absolute Maximum Ratings $T_C=25^\circ\text{C}$ unless otherwise specified

| Symbol | Parameter | TSP5N65M | TSF5N65M | Units |
|----------------|--|---------------------------|----------|---------------------|
| V_{DSS} | Drain-Source Voltage | 650 | | V |
| V_{GS} | Gate-Source Voltage | ± 30 | | V |
| I_D | Drain Current | $T_C = 25^\circ\text{C}$ | 4.5 | 4.5* |
| | | $T_C = 100^\circ\text{C}$ | 2.7 | 2.7* |
| I_{DM} | Pulsed Drain Current (Note 1) | 18 | 18* | A |
| E_{AS} | Single Pulsed Avalanche Energy (Note 2) | 180 | | mJ |
| E_{AR} | Repetitive Avalanche Energy (Note 1) | 10.4 | | mJ |
| dv/dt | Peak Diode Recovery dv/dt (Note 3) | 4.5 | | V/ns |
| P_D | Power Dissipation ($T_C = 25^\circ\text{C}$) -Derate above 25°C | 104 | 34 | W |
| | | 0.83 | 0.27 | W/ $^\circ\text{C}$ |
| T_J, T_{STG} | Operating and Storage Temperature Range | -55 to +150 | | $^\circ\text{C}$ |
| T_L | Maximum lead temperature for soldering purposes, 1/8" from case for 5 seconds | 300 | | $^\circ\text{C}$ |

* Drain current limited by maximum junction temperature.

Thermal Resistance Characteristics

| Symbol | Parameter | TSP5N65M | TSF5N65M | Units |
|-----------------|--|----------|----------|---------------------------|
| $R_{\theta JC}$ | Thermal Resistance,Junction-to-Case | 1.2 | 3.65 | $^\circ\text{C}/\text{W}$ |
| $R_{\theta CS}$ | Thermal Resistance,Case-to-Sink Typ. | 0.5 | -- | $^\circ\text{C}/\text{W}$ |
| $R_{\theta JA}$ | Thermal Resistance,Junction-to-Ambient | 62.5 | 62.5 | $^\circ\text{C}/\text{W}$ |

Electrical Characteristics $T_C=25\text{ }^\circ\text{C}$ unless otherwise specified

| Symbol | Parameter | Test Conditions | Min | Typ | Max | Units |
|--------|-----------|-----------------|-----|-----|-----|-------|
|--------|-----------|-----------------|-----|-----|-----|-------|

On Characteristics

| | | | | | | |
|--------------|-----------------------------------|---|-----|-----|-----|----------|
| V_{GS} | Gate Threshold Voltage | $V_{DS} = V_{GS}, I_D = 250\text{ }\mu\text{A}$ | 3.0 | -- | 5.0 | V |
| $R_{DS(ON)}$ | Static Drain-Source On-Resistance | $V_{GS} = 10\text{ V}, I_D = 2.25\text{ A}$ | -- | 2.5 | 3.0 | Ω |
| g_{FS} | Forward Transconductance | $V_{DS}=20\text{ V}, I_D=2.25\text{ A}$ | -- | 4.5 | -- | S |

Off Characteristics

| | | | | | | |
|--------------------------------|---|---|-----|-----|------|---------------------------|
| BV_{DSS} | Drain-Source Breakdown Voltage | $V_{GS} = 0\text{ V}, I_D = 250\text{ }\mu\text{A}$ | 650 | -- | -- | V |
| $\Delta BV_{DSS} / \Delta T_J$ | Breakdown Voltage Temperature Coefficient | $I_D = 250\text{ }\mu\text{A}$, Referenced to $25\text{ }^\circ\text{C}$ | -- | 0.6 | -- | $\text{V}/^\circ\text{C}$ |
| I_{DSS} | Zero Gate Voltage Drain Current | $V_{DS} = 650\text{ V}, V_{GS} = 0\text{ V}$ | -- | -- | 1 | μA |
| | | $V_{DS} = 520\text{ V}, T_J = 125\text{ }^\circ\text{C}$ | -- | -- | 10 | μA |
| I_{GSSF} | Gate-Body Leakage Current, Forward | $V_{GS} = 30\text{ V}, V_{DS} = 0\text{ V}$ | -- | -- | 100 | nA |
| I_{GSSR} | Gate-Body Leakage Current, Reverse | $V_{GS} = -30\text{ V}, V_{DS} = 0\text{ V}$ | -- | -- | -100 | nA |

Dynamic Characteristics

| | | | | | | |
|------------|------------------------------|--|----|-----|----|----|
| C_{iss} | Input Capacitance | $V_{DS} = 25\text{ V}, V_{GS} = 0\text{ V},$ $f = 1.0\text{ MHz}$ | -- | 720 | -- | pF |
| C_{oss} | Output Capacitance | | -- | 55 | -- | pF |
| C_{riss} | Reverse Transfer Capacitance | | -- | 7 | -- | pF |

Switching Characteristics

| | | | | | | |
|--------------|---------------------|--|----|-----|----|----|
| $t_{d(on)}$ | Turn-On Time | $V_{DS} = 325\text{ V}, I_D = 4.5\text{ A},$ $R_G = 25\text{ }\Omega$ (Note 4,5) | -- | 10 | -- | ns |
| t_r | Turn-On Rise Time | | -- | 40 | -- | ns |
| $t_{d(off)}$ | Turn-Off Delay Time | | -- | 40 | -- | ns |
| t_f | Turn-Off Fall Time | | -- | 50 | -- | ns |
| Q_g | Total Gate Charge | $V_{DS} = 520\text{ V}, I_D = 4.5\text{ A},$ $V_{GS} = 10\text{ V}$ (Note 4,5) | -- | 16 | -- | nC |
| Q_{gs} | Gate-Source Charge | | -- | 2.5 | -- | nC |
| Q_{gd} | Gate-Drain Charge | | -- | 6.5 | -- | nC |

Source-Drain Diode Maximum Ratings and Characteristics

| | | | | | | |
|----------|---|---|----|------|-----|---------------|
| I_S | Continuous Source-Drain Diode Forward Current | -- | -- | 4.5 | A | |
| I_{SM} | Pulsed Source-Drain Diode Forward Current | -- | -- | 18.0 | | |
| V_{SD} | Source-Drain Diode Forward Voltage | $I_S = 4.5\text{ A}, V_{GS} = 0\text{ V}$ | -- | -- | 1.4 | V |
| t_{rr} | Reverse Recovery Time | $I_S = 4.5\text{ A}, V_{GS} = 0\text{ V}$ | -- | 300 | -- | ns |
| Q_{rr} | Reverse Recovery Charge | $di_F/dt = 100\text{ A}/\mu\text{s}$ (Note 4) | -- | 2.0 | -- | μC |

NOTES:

1. Repetitive Rating: Pulse width limited by maximum junction temperature
2. $L=17\text{ mH}, I_{AS}=4.5\text{ A}, V_{DD}=50\text{ V}, R_G=25\text{ }\Omega$, Starting $T_J=25\text{ }^\circ\text{C}$
3. $I_{SD}\leq 4.5\text{ A}, di/dt \leq 200\text{ A}/\mu\text{s}, V_{DD} \leq BV_{DSS}$, Starting $T_J = 25\text{ }^\circ\text{C}$
4. Pulse Test: Pulse width $\leq 300\mu\text{s}$, Duty Cycle $\leq 2\%$
5. Essentially Independent of Operating Temperature Typical Characteristics

Typical Characteristics

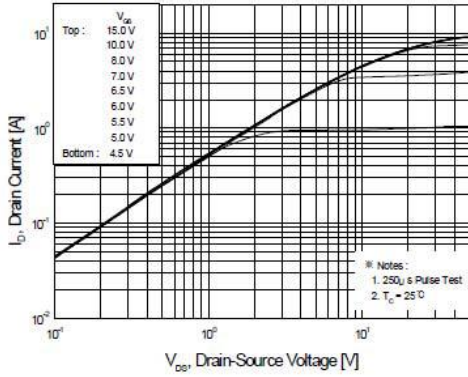

Figure 1. On-Region Characteristics

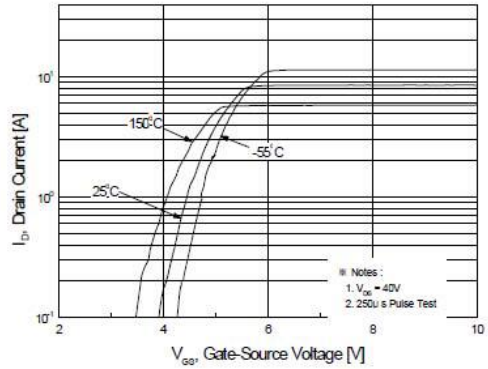

Figure 2. Transfer Characteristics

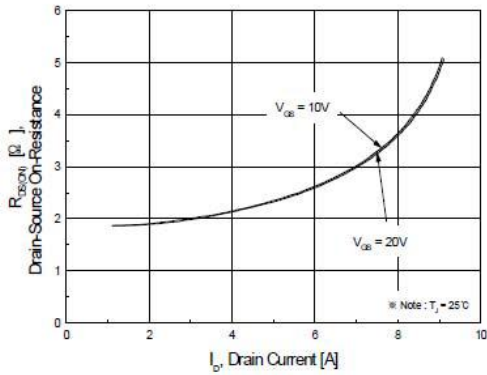

Figure 3. On-Resistance Variation vs. Drain Current and Gate Voltage

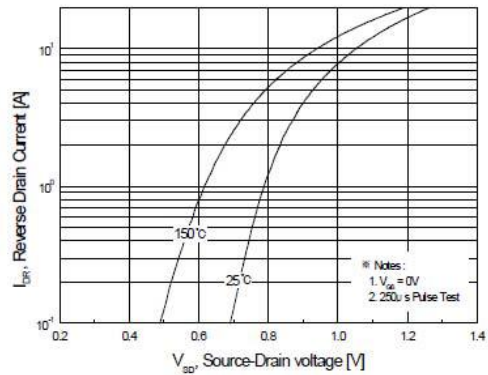

Figure 4. Body Diode Forward Voltage Variation with Source Current and Temperature

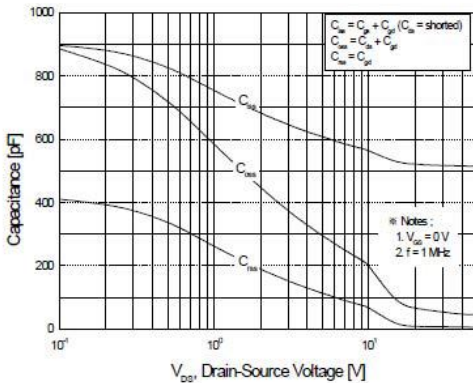

Figure 5. Capacitance Characteristics

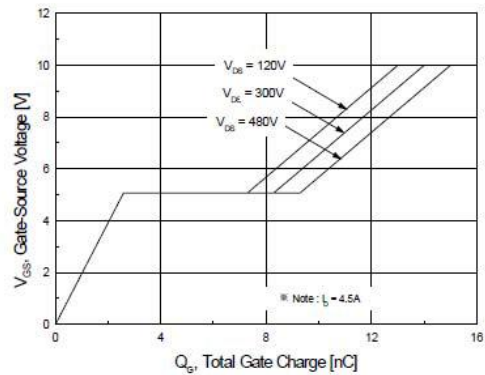

Figure 6. Gate Charge Characteristics

Typical Characteristics

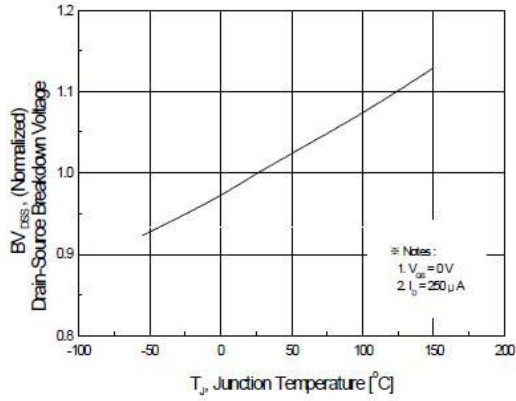

Figure 7. Breakdown Voltage Variation vs Temperature

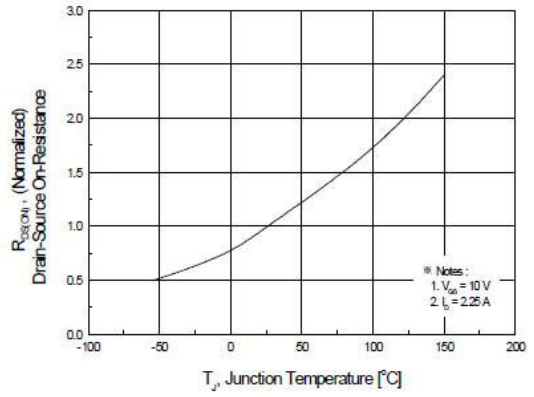

Figure 8. On-Resistance Variation vs Temperature

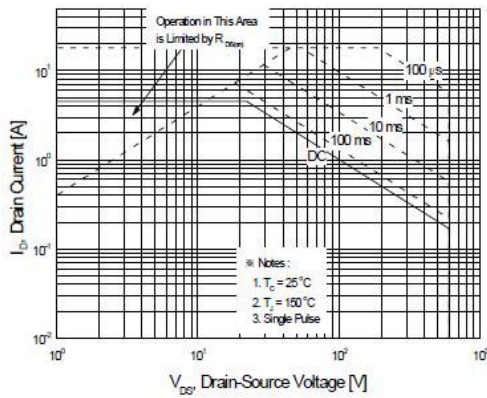

Figure 9-1. Maximum Safe Operating Area for TSP5N65M

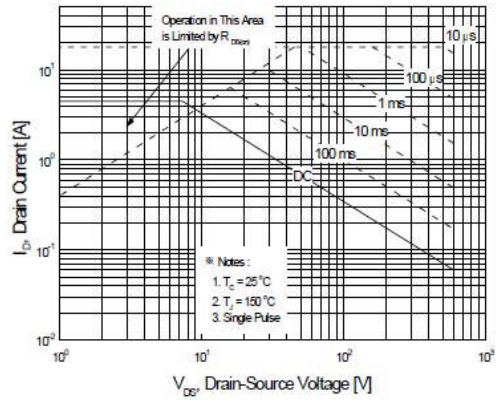

Figure 9-2. Maximum Safe Operating Area for TSP5N65M

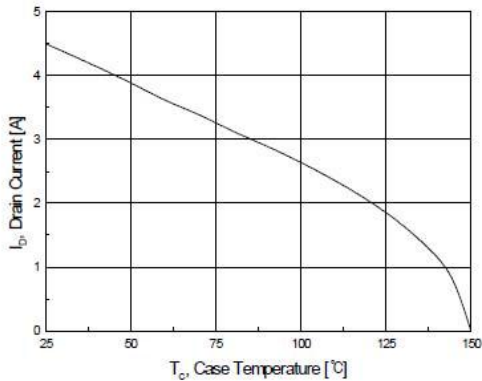

Figure 10. Maximum Drain Current vs Case Temperature

Typical Characteristics

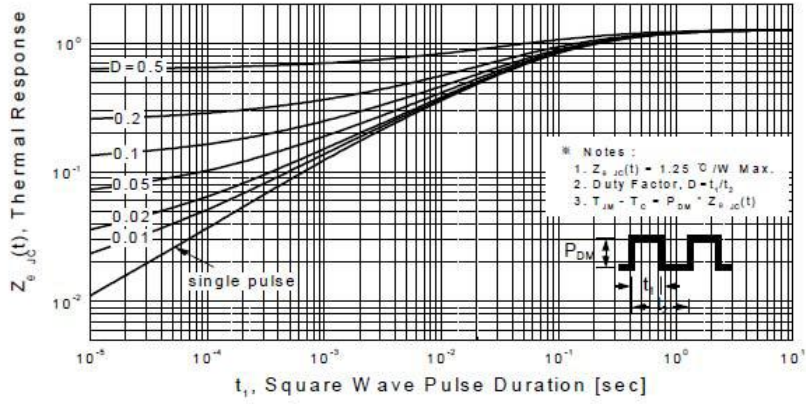

Figure 11-1. Transient Thermal Response Curve for TSP5N65M

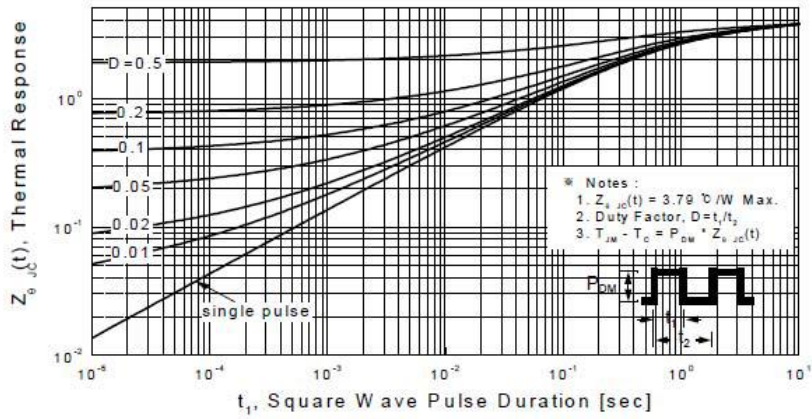

Figure 11-2. Transient Thermal Response Curve for TSP5N65M

Fig 12. Gate Charge Test Circuit & Waveform

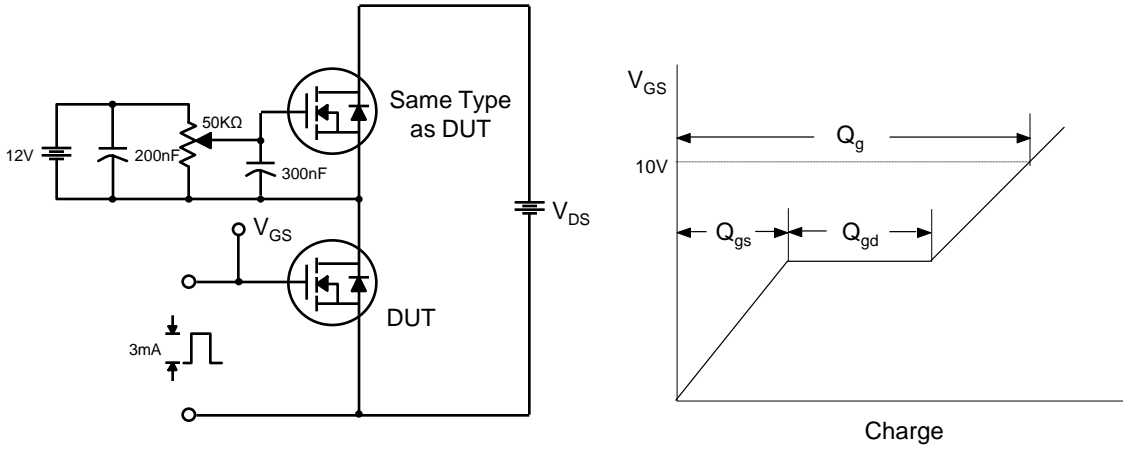

Fig 13. Resistive Switching Test Circuit & Waveforms

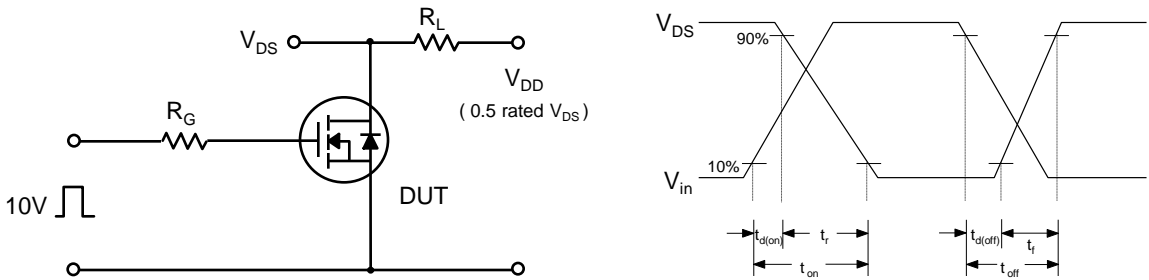

Fig 14. Unclamped Inductive Switching Test Circuit & Waveforms

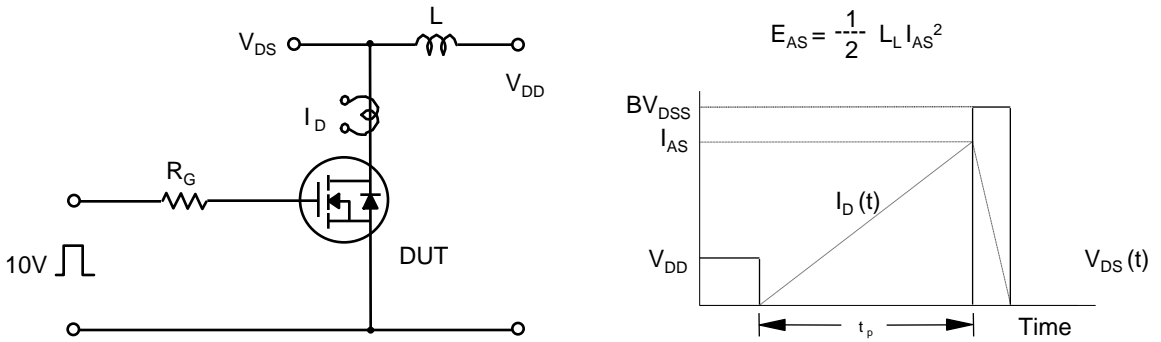
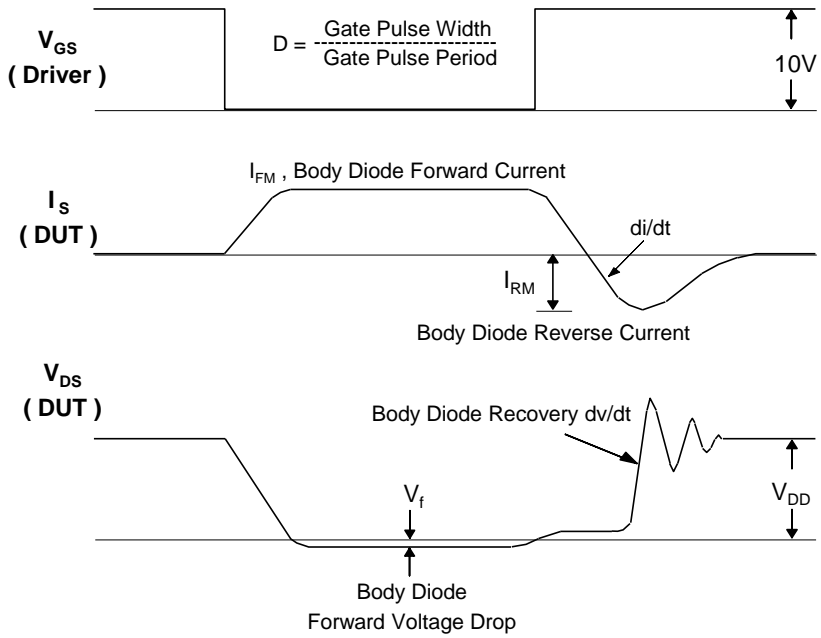
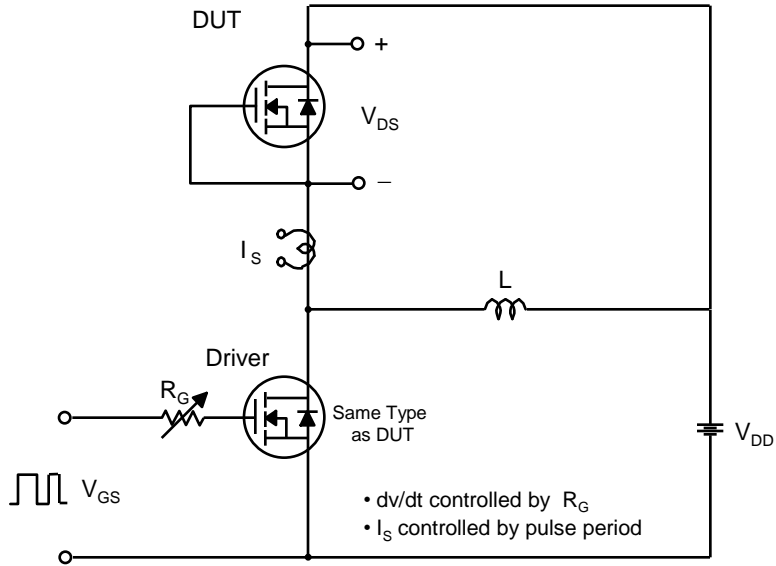
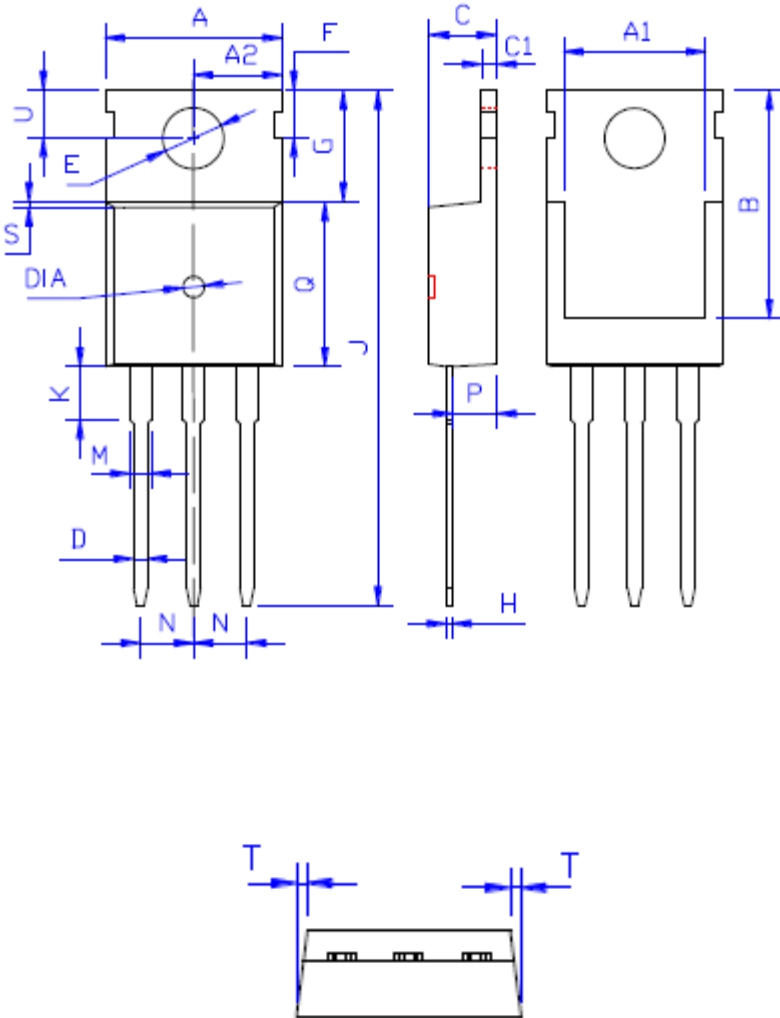

Fig 15. Peak Diode Recovery dv/dt Test Circuit & Waveforms



Package Dimension

TO-220



| DIM | MILLIMETERS |
|-----|---------------------------|
| A | 10.00±0.30 |
| A1 | 8.00±0.30 |
| A2 | 5.00±0.30 |
| B | 13.20±0.40 |
| C | 4.50±0.20 |
| C1 | 1.30±0.20 |
| D | 0.80±0.20 |
| E | 3.60±0.20 |
| F | 3.00±0.30 |
| G | 6.60±0.40 |
| H | 0.50±0.20 |
| J | 28.88±0.50 |
| K | 3.00±0.30 |
| M | 1.30±0.30 |
| N | Typical 2.54 |
| P | 2.40±0.40 |
| Q | 9.20±0.40 |
| S | 0.25±0.15 |
| T | 0.25±0.15 |
| U | 2.80±0.30 |
| DIA | 寬 1.50±0.10 深 0.50 MAX |

Package Dimension

TO-220F

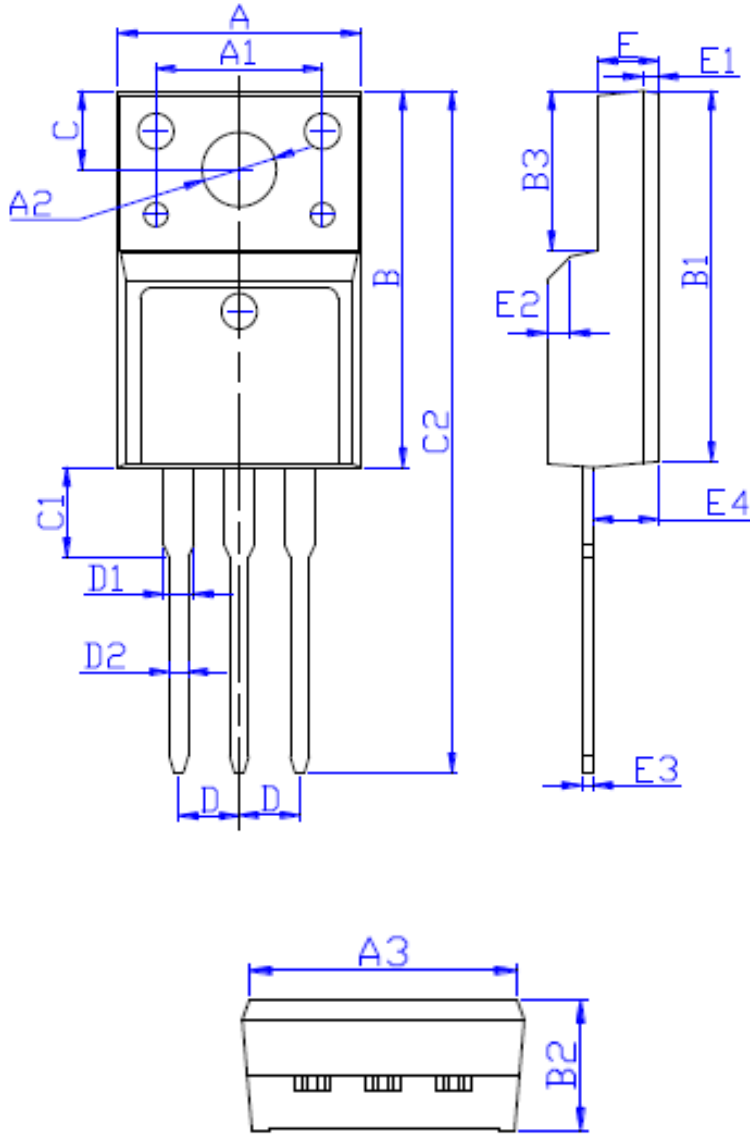

| DIM | MILLIMETERS |
|-----|--------------|
| A | 10.16 ± 0.30 |
| A1 | 7.00 ± 0.20 |
| A2 | 3.12 ± 0.20 |
| A3 | 9.70 ± 0.30 |
| B | 15.90 ± 0.50 |
| B1 | 15.60 ± 0.50 |
| B2 | 4.70 ± 0.30 |
| B3 | 6.70 ± 0.30 |
| C | 3.30 ± 0.25 |
| C1 | 3.25 ± 0.30 |
| C2 | 28.70 ± 0.50 |
| D | Typical 2.54 |
| D1 | 1.47 (MAX) |
| D2 | 0.80 ± 0.20 |
| E | 2.55 ± 0.25 |
| E1 | 0.70 ± 0.25 |
| E2 | 1.0 × 45° |
| E3 | 0.50 ± 0.20 |
| E4 | 2.75 ± 0.30 |

X-ON Electronics

Largest Supplier of Electrical and Electronic Components

Click to view similar products for [MOSFET](#) category:

Click to view products by [Truesemi](#) manufacturer:

Other Similar products are found below :

[614233C](#) [648584F](#) [MCH3443-TL-E](#) [MCH6422-TL-E](#) [FDPF9N50NZ](#) [FW216A-TL-2W](#) [FW231A-TL-E](#) [APT5010JVR](#) [NTNS3A92PZT5G](#)
[IRF100S201](#) [JANTX2N5237](#) [2SK2464-TL-E](#) [2SK3818-DL-E](#) [FCA20N60_F109](#) [FDZ595PZ](#) [STD6600NT4G](#) [FSS804-TL-E](#) [2SJ277-DL-E](#)
[2SK1691-DL-E](#) [2SK2545\(Q,T\)](#) [D2294UK](#) [405094E](#) [423220D](#) [MCH6646-TL-E](#) [TPCC8103,L1Q\(CM](#) [367-8430-0972-503](#) [VN1206L](#)
[424134F](#) [026935X](#) [051075F](#) [SBVS138LT1G](#) [614234A](#) [715780A](#) [NTNS3166NZT5G](#) [751625C](#) [873612G](#) [IRF7380TRHR](#)
[IPS70R2K0CEAKMA1](#) [RJK60S3DPP-E0#T2](#) [RJK60S5DPK-M0#T0](#) [APT5010JVFR](#) [APT12031JFLL](#) [APT12040JVR](#) [DMN3404LQ-7](#)
[NTE6400](#) [JANTX2N6796U](#) [JANTX2N6784U](#) [JANTXV2N5416U4](#) [SQM110N05-06L-GE3](#) [SIHF35N60E-GE3](#)