

LM2576 Series SIMPLE SWITCHER 3A Step-Down Voltage Regulator

General Description

The LM2576 series of regulators are monolithic integrated circuits that provide all the active functions for a step-down (buck) switching regulator, capable of driving 3A load with excellent line and load regulation. These devices are available in fixed output voltages of 3.3V, 5V, 12V, and an adjustable output version.

Requiring a minimum number of external components, these regulators are simple to use and include internal frequency compensation and a fixed-frequency oscillator.

The LM2576 series offers a high-efficiency replacement for popular three-terminal linear regulators. It substantially reduces the size of the heat sink, and in some cases no heat sink is required.

A standard series of inductors optimized for use with the LM2576 are available from several different manufacturers. This feature greatly simplifies the design of switch-mode power supplies.

Other features include a guaranteed $\pm 4\%$ tolerance on output voltage within specified input voltages and output load conditions, and $\pm 10\%$ on the oscillator frequency. External shutdown is included, featuring 50 μA (typical) standby current. The output switch includes cycle-by-cycle current limiting, as well as thermal shutdown for full protection under fault conditions.

Features

- 3.3V, 5V, 12V, and adjustable output versions
- Adjustable version output voltage range, 1.23V to 37V $\pm 4\%$ max over line and load conditions
- Guaranteed 3A output current
- Wide input voltage range, 40V
- Requires only 4 external components
- 52 kHz fixed frequency internal oscillator
- TTL shutdown capability, low power standby mode
- High efficiency
- Uses readily available standard inductors
- Thermal shutdown and current limit protection
- P+ Product Enhancement tested

Applications

- Simple high-efficiency step-down (buck) regulator
- Efficient pre-regulator for linear regulators
- On-card switching regulators
- Positive to negative converter (Buck-Boost)

Typical Application (Fixed Output Voltage Versions)

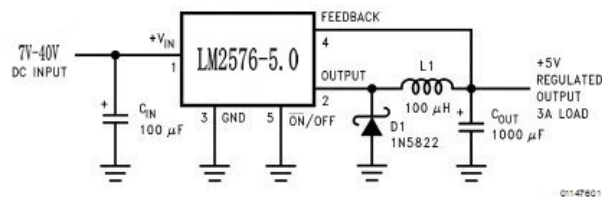
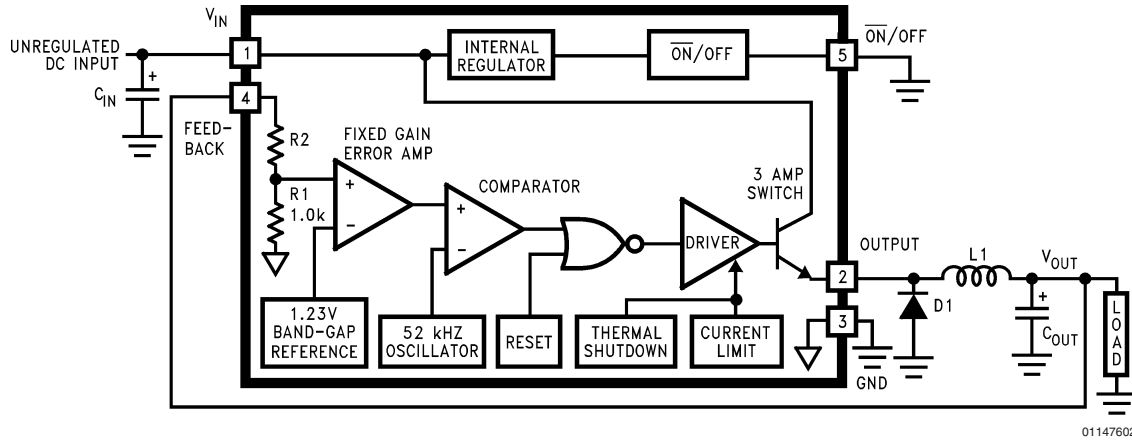

FIGURE 1.

FIGURE 1.

Block Diagram



3.3V R2 = 1.7k
5V, R2 = 3.1k
12V, R2 = 8.84k
15V, R2 = 11.3k

For ADJ. Version
R1 = Open, R2 = 0Ω
Patent Pending

Absolute Maximum Ratings (Note 1)

If Military/Aerospace specified devices are required, please contact the National Semiconductor Sales Office/Distributors for availability and specifications.

Maximum Supply Voltage

LM2576	45V
$\overline{\text{ON}}/\text{OFF}$ Pin Input Voltage	$-0.3\text{V} \leq V \leq +V_{\text{IN}}$
Output Voltage to Ground (Steady State)	-1V
Power Dissipation	Internally Limited
Storage Temperature Range	-65°C to $+150^{\circ}\text{C}$
Maximum Junction Temperature	150°C

Minimum ESD Rating

(C = 100 pF, R = 1.5 kΩ) 2 kV

Lead Temperature

(Soldering, 10 Seconds) 260°C

Operating Ratings

Temperature Range

LM2576 $-40^{\circ}\text{C} \leq T_{\text{J}} \leq +125^{\circ}\text{C}$

Supply Voltage

LM2576 40V

LM2576-3.3 Electrical Characteristics

Specifications with standard type face are for $T_J = 25^\circ\text{C}$, and those with **boldface type** apply over full Operating Temperature Range.

Symbol	Parameter	Conditions	LM2576-3.3		Units (Limits)
			Typ	Limit (Note 2)	
SYSTEM PARAMETERS (Note 3) Test Circuit Figure 2					
V_{OUT}	Output Voltage	$V_{IN} = 12\text{V}$, $I_{LOAD} = 0.5\text{A}$ Circuit of <i>Figure 2</i>	3.3	3.234 3.366	V V(Min) V(Max)
V_{OUT}	Output Voltage LM2576	$6\text{V} \leq V_{IN} \leq 40\text{V}$, $0.5\text{A} \leq I_{LOAD} \leq 3\text{A}$ Circuit of <i>Figure 2</i>	3.3	3.168/ 3.135 3.432/ 3.465	V V(Min) V(Max)
η	Efficiency	$V_{IN} = 12\text{V}$, $I_{LOAD} = 3\text{A}$	75		%

LM2576-5.0 Electrical Characteristics

Specifications with standard type face are for $T_J = 25^\circ\text{C}$, and those with *Figure 2* **boldface type** apply over full Operating Temperature Range.

Symbol	Parameter	Conditions	LM2576-5.0		Units (Limits)
			Typ	Limit (Note 2)	
SYSTEM PARAMETERS (Note 3) Test Circuit Figure 2					
V_{OUT}	Output Voltage	$V_{IN} = 12\text{V}$, $I_{LOAD} = 0.5\text{A}$ Circuit of <i>Figure 2</i>	5.0	4.900 5.100	V V(Min) V(Max)
V_{OUT}	Output Voltage LM2576	$0.5\text{A} \leq I_{LOAD} \leq 3\text{A}$, $8\text{V} \leq V_{IN} \leq 40\text{V}$ Circuit of <i>Figure 2</i>	5.0	4.800/ 4.750 5.200/ 5.250	V V(Min) V(Max)

LM2576-5.0 Electrical Characteristics

Specifications with standard type face are for $T_J = 25^\circ\text{C}$, and those with *Figure 2 boldface type* apply over full Operating Temperature Range.

Symbol	Parameter	Conditions	LM2576-5.0		Units (Limits)
			Typ	Limit (Note 2)	
SYSTEM PARAMETERS (Note 3) Test Circuit Figure 2					
η	Efficiency	$V_{IN} = 12\text{V}$, $I_{LOAD} = 3\text{A}$	77		%

LM2576-12 Electrical Characteristics

Specifications with standard type face are for $T_J = 25^\circ\text{C}$, and those with **boldface type** apply over full Operating Temperature Range.

Symbol	Parameter	Conditions	LM2576-12		Units (Limits)
			Typ	Limit (Note 2)	
SYSTEM PARAMETERS (Note 3) Test Circuit Figure 2					
V_{OUT}	Output Voltage	$V_{IN} = 25\text{V}$, $I_{LOAD} = 0.5\text{A}$ Circuit of <i>Figure 2</i>	12	11.76 12.24	V V(Min) V(Max)
V_{OUT}	Output Voltage LM2576	$0.5\text{A} \leq I_{LOAD} \leq 3\text{A}$, $15\text{V} \leq V_{IN} \leq 40\text{V}$ Circuit of <i>Figure 2</i>	12	11.52/ 11.40 12.48/ 12.60	V V(Min) V(Max)
η	Efficiency	$V_{IN} = 15\text{V}$, $I_{LOAD} = 3\text{A}$	88		%

Specifications with standard type face are for $T_J = 25^\circ\text{C}$, and those with **boldface type** apply over full Operating Temperature Range.

Symbol	Parameter	Conditions	LM2576-ADJ		Units (Limits)
			Typ	Limit (Note 2)	
SYSTEM PARAMETERS (Note 3) Test Circuit Figure 2					
V_{OUT}	Feedback Voltage	$V_{IN} = 12\text{V}$, $I_{LOAD} = 0.5\text{A}$ $V_{OUT} = 5\text{V}$, Circuit of Figure 2	1.230	1.217 1.243	V V(Min) V(Max)
V_{OUT}	Feedback Voltage LM2576	$0.5\text{A} \leq I_{LOAD} \leq 3\text{A}$, $8\text{V} \leq V_{IN} \leq 40\text{V}$ $V_{OUT} = 5\text{V}$, Circuit of Figure 2	1.230	1.193/ 1.180 1.267/ 1.280	V V(Min) V(Max)
η	Efficiency	$V_{IN} = 12\text{V}$, $I_{LOAD} = 3\text{A}$, $V_{OUT} = 5\text{V}$	77		%

All Output Voltage Versions Electrical Characteristics

Specifications with standard type face are for $T_J = 25^\circ\text{C}$, and those with **boldface type** apply over full Operating Temperature Range. Unless otherwise specified, $V_{IN} = 12\text{V}$ for the 3.3V, 5V, and Adjustable version, $V_{IN} = 25\text{V}$ for the 12V version, and $V_{IN} = 30\text{V}$ for the 15V version. $I_{LOAD} = 500\text{mA}$.

Symbol	Parameter	Conditions	LM2576-XX		Units (Limits)
			Typ	Limit (Note 2)	
DEVICE PARAMETERS					
I_b	Feedback Bias Current	$V_{OUT} = 5\text{V}$ (Adjustable Version Only)	50	100/ 500	nA
f_O	Oscillator Frequency	(Note 11)	52	47/ 42 58/ 63	kHz kHz (Min) kHz (Max)
V_{SAT}	Saturation Voltage	$I_{OUT} = 3\text{A}$ (Note 4)	1.4	1.8/ 2.0	V V(Max)
DC	Max Duty Cycle (ON)	(Note 5)	98	93	% %(Min)
I_{CL}	Current Limit	(Notes 4, 11)	5.8	4.2/ 3.5 6.9/ 7.5	A A(Min) A(Max)
I_L	Output Leakage Current	(Notes 6, 7): Output = 0V Output = -1V Output = -1V	7.5	2 30	mA(Max) mA mA(Max)
I_Q	Quiescent Current	(Note 6)	5	10	mA mA(Max)
I_{STBY}	Standby Quiescent Current	$\overline{\text{ON}} / \text{OFF Pin} = 5\text{V}$ (OFF)	50	200	μA $\mu\text{A}(\text{Max})$

Specifications with standard type face are for $T_J = 25^\circ\text{C}$, and those with **boldface type** apply over full Operating Temperature Range. Unless otherwise specified, $V_{IN} = 12\text{V}$ for the 3.3V, 5V, and Adjustable version, $V_{IN} = 25\text{V}$ for the 12V version, and $V_{IN} = 30\text{V}$ for the 15V version. $I_{LOAD} = 500\text{ mA}$.

Symbol	Parameter	Conditions	LM2576-XX		Units (Limits)
			Typ	Limit (Note 2)	

DEVICE PARAMETERS

θ_{JA}	Thermal Resistance	T Package, Junction to Ambient (Note 8)	65		$^\circ\text{C/W}$
θ_{JA}		T Package, Junction to Ambient (Note 9)	45		
θ_{JC}		T Package, Junction to Case	2		
θ_{JA}		S Package, Junction to Ambient (Note 10)	50		

ON /OFF CONTROL Test Circuit Figure 2

V_{IH}	$\overline{\text{ON}}$ /OFF Pin	$V_{OUT} = 0\text{V}$	1.4	2.2/2.4	V(Min)
V_{IL}	Logic Input Level	$V_{OUT} = \text{Nominal Output Voltage}$	1.2	1.0/0.8	V(Max)
I_{IH}	$\overline{\text{ON}}$ /OFF Pin Input Current	$\overline{\text{ON}}$ /OFF Pin = 5V (OFF)	12	30	μA $\mu\text{A(Max)}$
I_{IL}		$\overline{\text{ON}}$ /OFF Pin = 0V (ON)	0	10	μA $\mu\text{A(Max)}$

Note 1: Absolute Maximum Ratings indicate limits beyond which damage to the device may occur. Operating Ratings indicate conditions for which the device is intended to be functional, but do not guarantee specific performance limits. For guaranteed specifications and test conditions, see the Electrical Characteristics.

Note 2: All limits guaranteed at room temperature (standard type face) and at temperature extremes (bold type face). All room temperature limits are 100% production tested. All limits at temperature extremes are guaranteed via correlation using standard Statistical Quality Control (SQC) methods.

Note 3: External components such as the catch diode, inductor, input and output capacitors can affect switching regulator system performance. When the LM2576 is used as shown in the Figure 2 test circuit, system performance will be as shown in system parameters section of Electrical Characteristics.

Note 4: Output pin sourcing current. No diode, inductor or capacitor connected to output.

Note 5: Feedback pin removed from output and connected to 0V.

Note 6: Feedback pin removed from output and connected to +12V for the Adjustable, 3.3V, and 5V versions, and +25V for the 12V and 15V versions, to force the output transistor OFF.

Note 7: $V_{IN} = 40\text{V}$ (60V for high voltage version).

Note 8: Junction to ambient thermal resistance (no external heat sink) for the 5 lead TO-220 package mounted vertically, with 1/2 inch leads in a socket, or on a PC board with minimum copper area.

Note 9: Junction to ambient thermal resistance (no external heat sink) for the 5 lead TO-220 package mounted vertically, with 1/4 inch leads soldered to a PC board containing approximately 4 square inches of copper area surrounding the leads.

Note 10: If the TO-263 package is used, the thermal resistance can be reduced by increasing the PC board copper area thermally connected to the package. Using 0.5 square inches of copper area, θ_{JA} is 50 $^\circ\text{C/W}$, with 1 square inch of copper area, θ_{JA} is 37 $^\circ\text{C/W}$, and with 1.6 or more square inches of copper area, θ_{JA} is 32 $^\circ\text{C/W}$.

Note 11: The oscillator frequency reduces to approximately 11 kHz in the event of an output short or an overload which causes the regulated output voltage to drop approximately 40% from the nominal output voltage. This self protection feature lowers the average power dissipation of the IC by lowering the minimum duty cycle from 5% down to approximately 2%.

Typical Performance Characteristics

(Circuit of Figure 2)

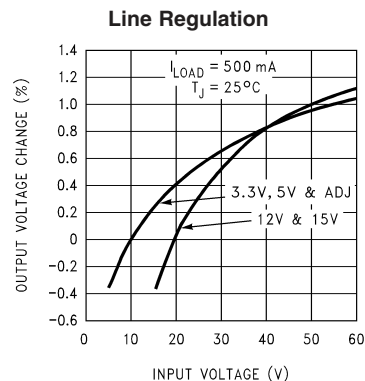
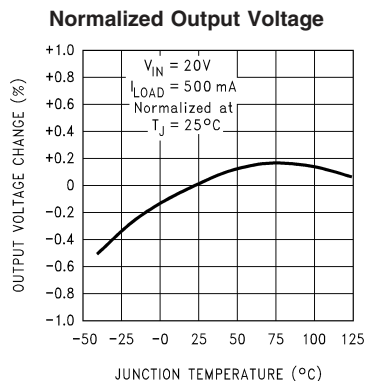

Typical Performance Characteristics (Circuit of Figure 2) (Continued)

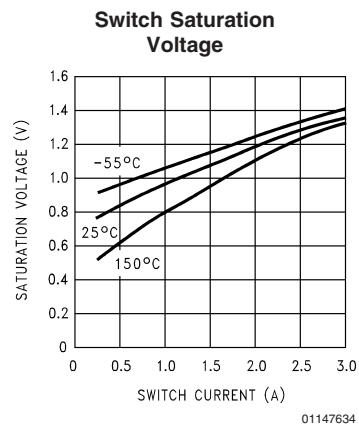
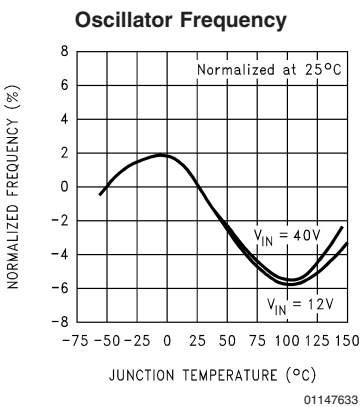
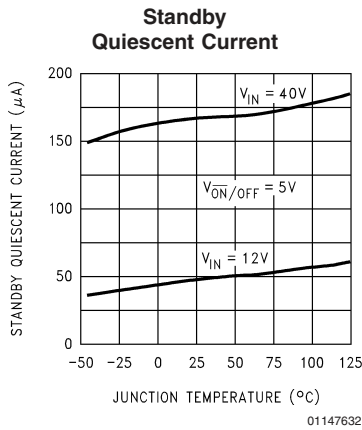
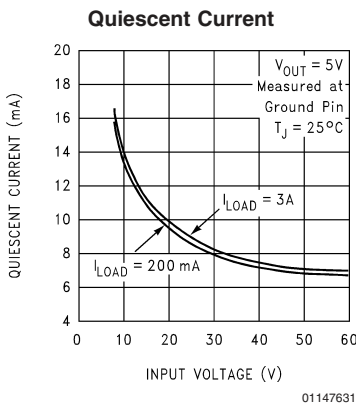
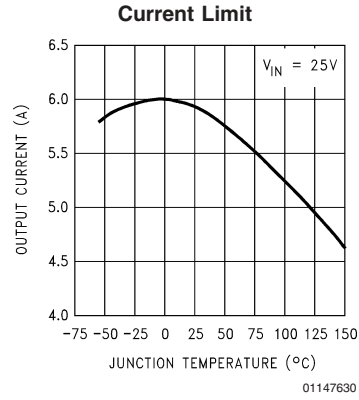
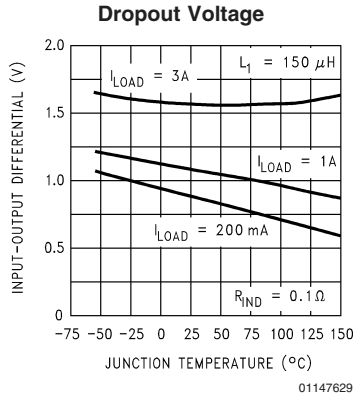

Typical Performance Characteristics (Circuit of Figure 2) (Continued)

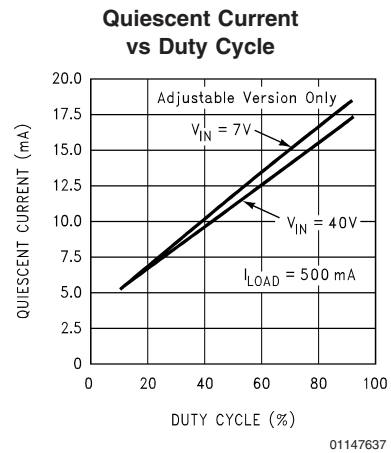
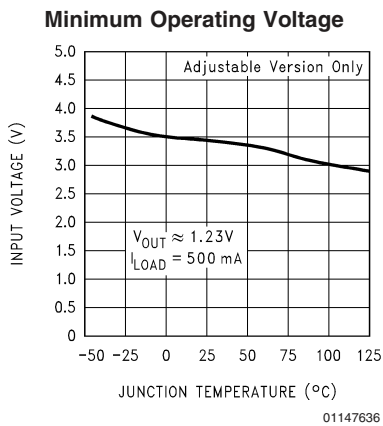
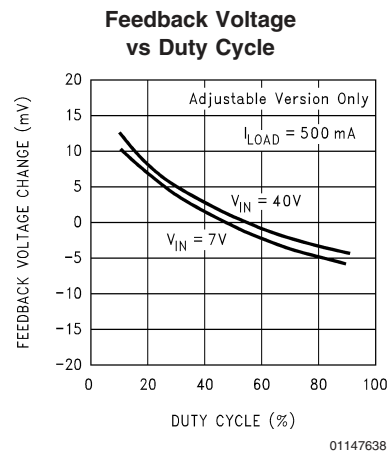
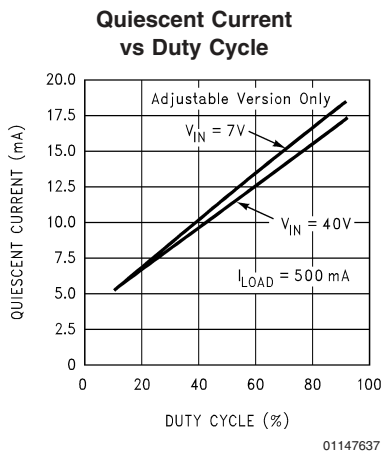
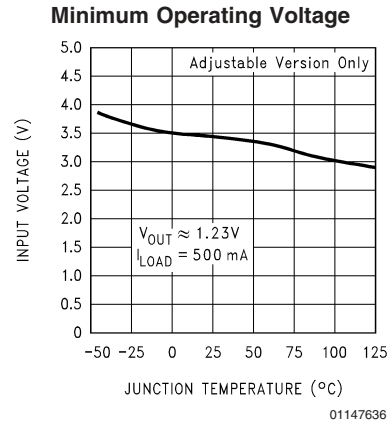
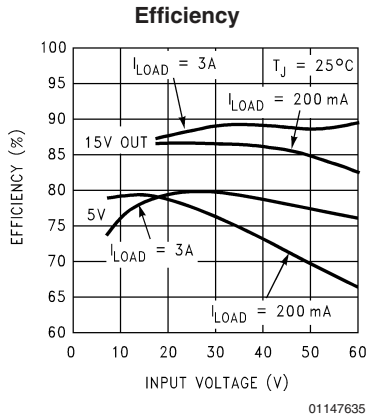

LM2576 Series Buck Regulator Design Procedure (Continued)

INDUCTOR VALUE SELECTION GUIDES (For Continuous Mode Operation)

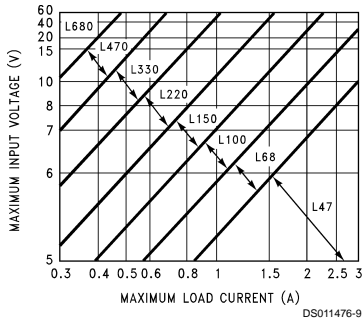

FIGURE 3. LM2576(HV)-3.3

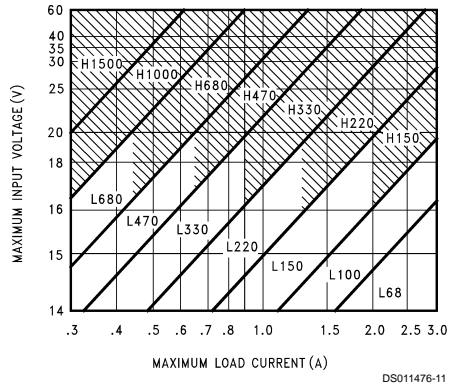

FIGURE 5. LM2576(HV)-12

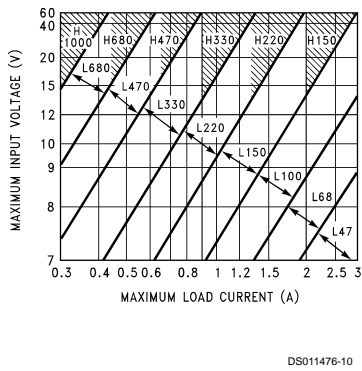

FIGURE 4. LM2576(HV)-5.0

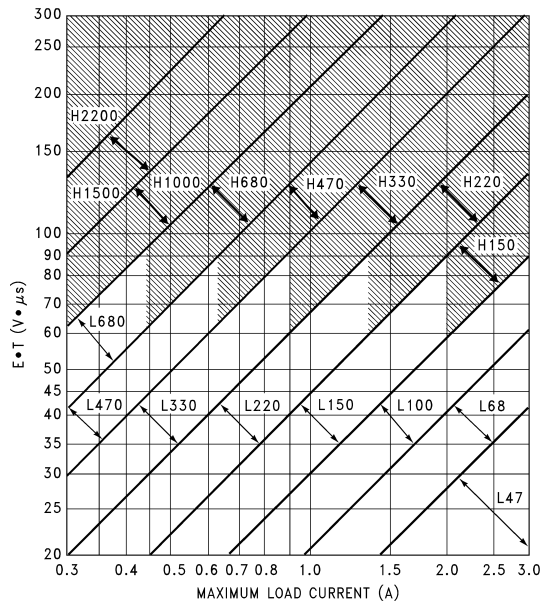
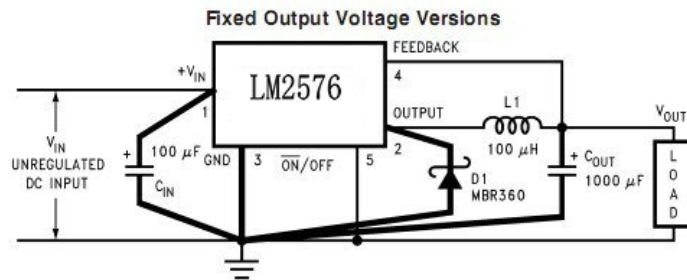

FIGURE 7. LM2576(HV)-ADJ

Test Circuit and Layout Guidelines

As in any switching regulator, layout is very important. Rapidly switching currents associated with wiring inductance generate voltage transients which can cause problems. For minimal inductance and ground loops, the length of the leads indicated by heavy lines should be kept as short as possible.

Single-point grounding (as indicated) or ground plane construction should be used for best results. When using the Adjustable version, physically locate the programming resistors near the regulator, to keep the sensitive feedback wiring short.



01147607

- C_{IN} — 100 µF, 75V, Aluminum Electrolytic
- C_{OUT} — 1000 µF, 25V, Aluminum Electrolytic
- D₁ — Schottky, MBR360
- L₁ — 100 µH, Pulse Eng. PE-92108
- R₁ — 2k, 0.1%
- R₂ — 6.12k, 0.1%

Adjustable Output Voltage Version

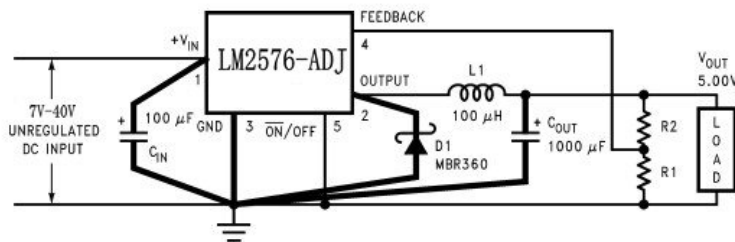

01147608

$$V_{OUT} = V_{REF} \left(1 + \frac{R_2}{R_1} \right)$$

$$R_2 = R_1 \left(\frac{V_{OUT}}{V_{REF}} - 1 \right)$$

where $V_{REF} = 1.23V$, R_1 between 1k and 5k.

FIGURE 2.

LM2576 Series Buck Regulator Design Procedure

PROCEDURE (Adjustable Output Voltage Versions)

2. Inductor Selection (L1) A. Calculate the inductor Volt • microsecond constant, E • T (V • μs), from the following formula:

$$E \cdot T = (V_{IN} - V_{OUT}) \frac{V_{OUT}}{V_{IN}} \cdot \frac{1000}{F \text{ (in kHz)}} \text{ (V} \cdot \mu\text{s)}$$

B. Use the E • T value from the previous formula and match it with the E • T number on the vertical axis of the **Inductor Value Selection Guide** shown in *Figure 7*. C. On the horizontal axis, select the maximum load current. D. Identify the inductance region intersected by the E • T value and the maximum load current value, and note the inductor code for that region. E. Identify the inductor value from the inductor code, and select an appropriate inductor from the table shown in *Figure 9*. Part numbers are listed for three inductor manufacturers. The inductor chosen must be rated for operation at the LM2576 switching frequency (52 kHz) and for a current rating of 1.15 x I_{LOAD}. For additional inductor information, see the inductor section in the application hints section of this data sheet.

3. Output Capacitor Selection (C_{OUT}) A. The value of the output capacitor together with the inductor defines the dominate pole-pair of the switching regulator loop. For stable operation, the capacitor must satisfy the following requirement:

$$C_{OUT} \geq 13,300 \frac{V_{IN}(\text{Max})}{V_{OUT} \cdot L(\mu\text{H})} \text{ (}\mu\text{F)}$$

The above formula yields capacitor values between 10 μF and 2200 μF that will satisfy the loop requirements for stable operation. But to achieve an acceptable output ripple voltage, (approximately 1% of the output voltage) and transient response, the output capacitor may need to be several times larger than the above formula yields. B. The capacitor's voltage rating should be at least 1.5 times greater than the output voltage. For a 10V regulator, a rating of at least 15V or more is recommended. Higher voltage electrolytic capacitors generally have lower ESR numbers, and for this reason it may be necessary to select a capacitor rate for a higher voltage than would normally be needed.

4. Catch Diode Selection (D1) A. The catch-diode current rating must be at least 1.2 times greater than the maximum load current. Also, if the power supply design must withstand a continuous output short, the diode should have a current rating equal to the maximum current limit of the LM2576. The most stressful condition for this diode is an overload or shorted output. See diode selection guide in *Figure 8*. B. The reverse voltage rating of the diode should be at least 1.25 times the maximum input voltage.

5. Input Capacitor (C_{IN}) An aluminum or tantalum electrolytic bypass capacitor located close to the regulator is needed for stable operation.

To further simplify the buck regulator design procedure, National Semiconductor is making available computer design software to be used with the SIMPLE SWITCHER line of

EXAMPLE (Adjustable Output Voltage Versions)

2. Inductor Selection (L1) A. Calculate E • T (V • μs)

$$E \cdot T = (25 - 10) \cdot \frac{10}{25} \cdot \frac{1000}{52} = 115 \text{ V} \cdot \mu\text{s}$$

B. E • T = 115 V • μs C. I_{LOAD}(Max) = 3A D. Inductance Region = H150 E. Inductor Value = 150 μH Choose from **AIE part #415-0936 Pulse Engineering part #PE-531115**, or **Renco part #RL2445**.

3. Output Capacitor Selection (C_{OUT})

$$C_{OUT} > 13,300 \frac{25}{10 \cdot 150} = 22.2 \mu\text{F}$$

However, for acceptable output ripple voltage select C_{OUT} ≥ 680 μF C_{OUT} = 680 μF electrolytic capacitor

4. Catch Diode Selection (D1) A. For this example, a 3.3A current rating is adequate. B. Use a 30V 31DQ03 Schottky diode, or any of the suggested fast-recovery diodes in *Figure 8*.

5. Input Capacitor (C_{IN}) A 100 μF aluminum electrolytic capacitor located near the input and ground pins provides sufficient bypassing.

switching regulators. **Switchers Made Simple** (Version 3.3) is available on a (3½") diskette for IBM compatible computers from a National Semiconductor sales office in your area.

Additional Applications

The switch currents in this buck-boost configuration are higher than in the standard buck-mode design, thus lowering the available output current. Also, the start-up input current of the buck-boost converter is higher than the standard buck-mode regulator, and this may overload an input power source with a current limit less than 5A. Using a delayed turn-on or an undervoltage lockout circuit (described in the next section) would allow the input voltage to rise to a high enough level before the switcher would be allowed to turn on.

Because of the structural differences between the buck and the buck-boost regulator topologies, the buck regulator design procedure section can not be used to select the inductor or the output capacitor. The recommended range of inductor values for the buck-boost design is between 68 μ H and 220 μ H, and the output capacitor values must be larger than what is normally required for buck designs. Low input voltages or high output currents require a large value output capacitor (in the thousands of micro Farads).

The peak inductor current, which is the same as the peak switch current, can be calculated from the following formula:

$$I_p \approx \frac{I_{LOAD}(V_{IN} + |V_O|)}{V_{IN}} + \frac{V_{IN}|V_O|}{V_{IN} + |V_O|} \times \frac{1}{2L_1 f_{osc}}$$

Where $f_{osc} = 52$ kHz. Under normal continuous inductor current operating conditions, the minimum V_{IN} represents the worst case. Select an inductor that is rated for the peak current anticipated.

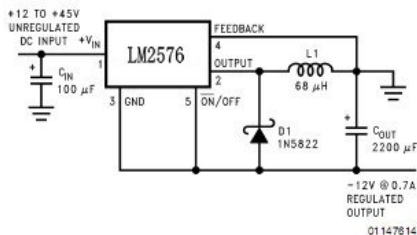

FIGURE 10. Inverting Buck-Boost Develops -12V

Also, the maximum voltage appearing across the regulator is the absolute sum of the input and output voltage. For a -12V output, the maximum input voltage for the LM2576 is +28V, or +48V for the LM2576HV.

The *Switchers Made Simple* (version 3.0) design software can be used to determine the feasibility of regulator designs using different topologies, different input-output parameters, different components, etc.

NEGATIVE BOOST REGULATOR

Another variation on the buck-boost topology is the negative boost configuration. The circuit in Figure 11 accepts an input voltage ranging from -5V to -12V and provides a regulated -12V output. Input voltages greater than -12V will cause the output to rise above -12V, but will not damage the regulator.

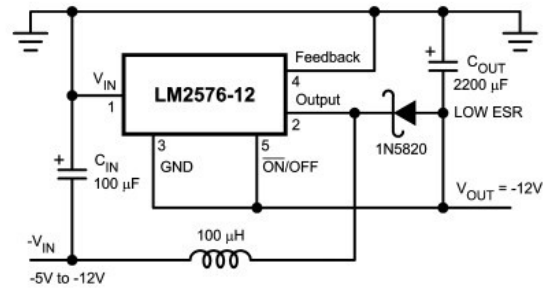

Typical Load Current

400 mA for $V_{IN} = -5.2V$

750 mA for $V_{IN} = -7V$

Note: Heat sink may be required.

01147615

FIGURE 11. Negative Boost

Because of the boosting function of this type of regulator, the switch current is relatively high, especially at low input voltages. Output load current limitations are a result of the maximum current rating of the switch. Also, boost regulators can not provide current limiting load protection in the event of a shorted load, so some other means (such as a fuse) may be necessary.

UNDERVOLTAGE LOCKOUT

In some applications it is desirable to keep the regulator off until the input voltage reaches a certain threshold. An undervoltage lockout circuit which accomplishes this task is shown in Figure 12, while Figure 13 shows the same circuit applied to a buck-boost configuration. These circuits keep the regulator off until the input voltage reaches a predetermined level.

$$V_{TH} \approx V_{Z1} + 2V_{BE}(Q1)$$

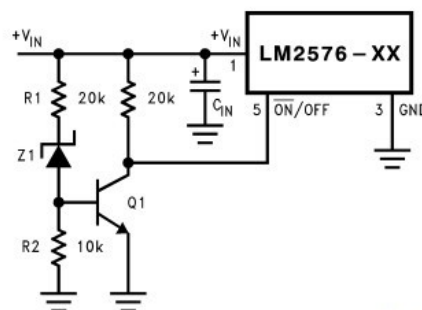

Note: Complete circuit not shown.

01147618

FIGURE 12. Undervoltage Lockout for Buck Circuit

Additional Applications

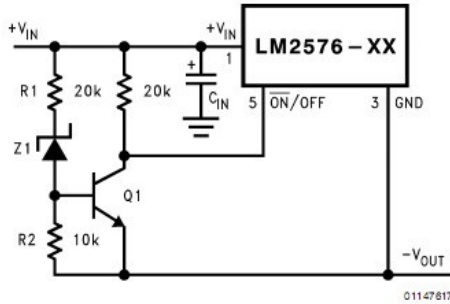

Note: Complete circuit not shown (see Figure 10).

FIGURE 13. Undervoltage Lockout for Buck-Boost Circuit

DELAYED STARTUP

The $\overline{\text{ON}}/\text{OFF}$ pin can be used to provide a delayed startup feature as shown in Figure 14. With an input voltage of 20V and for the part values shown, the circuit provides approximately 10 ms of delay time before the circuit begins switch-

ing. Increasing the RC time constant can provide longer delay times. But excessively large RC time constants can cause problems with input voltages that are high in 60 Hz or 120 Hz ripple, by coupling the ripple into the $\overline{\text{ON}}/\text{OFF}$ pin.

ADJUSTABLE OUTPUT, LOW-RIPPLE POWER SUPPLY

A 3A power supply that features an adjustable output voltage is shown in Figure 15. An additional L-C filter that reduces the output ripple by a factor of 10 or more is included in this circuit.

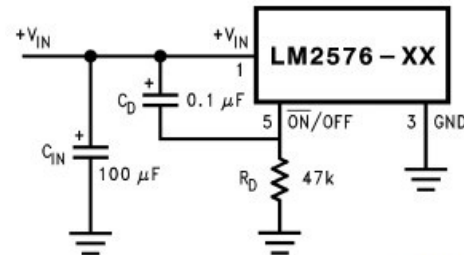

Note: Complete circuit not shown.

FIGURE 14. Delayed Startup

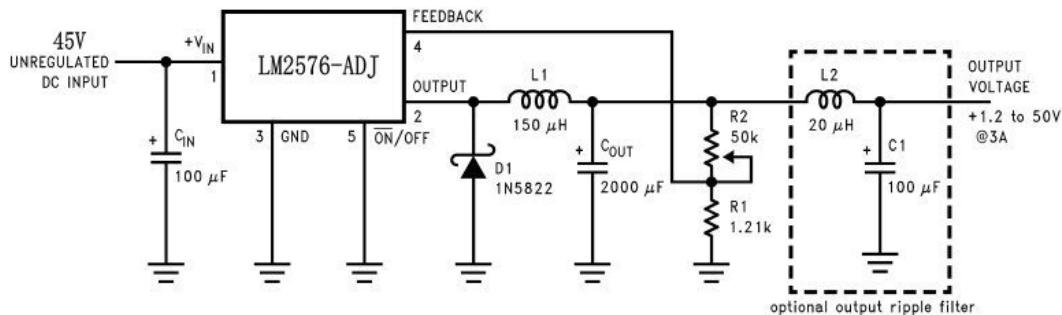

FIGURE 15. 1.2V to 37V Adjustable 3A Power Supply with Low Output Ripple

Definition of Terms

BUCK REGULATOR

A switching regulator topology in which a higher voltage is converted to a lower voltage. Also known as a step-down switching regulator.

BUCK-BOOST REGULATOR

A switching regulator topology in which a positive voltage is converted to a negative voltage without a transformer.

DUTY CYCLE (D)

Ratio of the output switch's on-time to the oscillator period.

$$\text{for buck regulator} \quad D = \frac{t_{\text{ON}}}{T} = \frac{V_{\text{OUT}}}{V_{\text{IN}}}$$

$$\text{for buck-boost regulator} \quad D = \frac{t_{\text{ON}}}{T} = \frac{|V_{\text{O}}|}{|V_{\text{O}}| + V_{\text{IN}}}$$

CATCH DIODE OR CURRENT STEERING DIODE

The diode which provides a return path for the load current when the LM2576 switch is OFF.

EFFICIENCY (η)

The proportion of input power actually delivered to the load.

$$\eta = \frac{P_{\text{OUT}}}{P_{\text{IN}}} = \frac{P_{\text{OUT}}}{P_{\text{OUT}} + P_{\text{LOSS}}}$$

Definition of Terms

CAPACITOR EQUIVALENT SERIES RESISTANCE (ESR)

The purely resistive component of a real capacitor's impedance (see *Figure 16*). It causes power loss resulting in capacitor heating, which directly affects the capacitor's operating lifetime. When used as a switching regulator output filter, higher ESR values result in higher output ripple voltages.

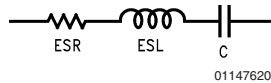

FIGURE 16. Simple Model of a Real Capacitor

Most standard aluminum electrolytic capacitors in the 100 μF –1000 μF range have 0.5 Ω to 0.1 Ω ESR. Higher-grade capacitors (“low-ESR”, “high-frequency”, or “low-inductance”) in the 100 μF –1000 μF range generally have ESR of less than 0.15 Ω .

EQUIVALENT SERIES INDUCTANCE (ESL)

The pure inductance component of a capacitor (see *Figure 16*). The amount of inductance is determined to a large extent on the capacitor's construction. In a buck regulator, this unwanted inductance causes voltage spikes to appear on the output.

OUTPUT RIPPLE VOLTAGE

The AC component of the switching regulator's output voltage. It is usually dominated by the output capacitor's ESR multiplied by the inductor's ripple current (ΔI_{IND}). The peak-to-peak value of this sawtooth ripple current can be determined by reading the Inductor Ripple Current section of the Application hints.

CAPACITOR RIPPLE CURRENT

RMS value of the maximum allowable alternating current at which a capacitor can be operated continuously at a specified temperature.

STANDBY QUIESCENT CURRENT (I_{STBY})

Supply current required by the LM2576 when in the standby mode ($\overline{\text{ON}}$ /OFF pin is driven to TTL-high voltage, thus turning the output switch OFF).

INDUCTOR RIPPLE CURRENT (ΔI_{IND})

The peak-to-peak value of the inductor current waveform, typically a sawtooth waveform when the regulator is operating in the continuous mode (vs. discontinuous mode).

OPERATING VOLT MICROSECOND CONSTANT ($E \cdot T_{\text{op}}$)

The product (in Volt $\cdot\mu\text{s}$) of the voltage applied to the inductor and the time the voltage is applied. This $E \cdot T_{\text{op}}$ constant is a measure of the energy handling capability of an inductor and is dependent upon the type of core, the core area, the number of turns, and the duty cycle.

Connection Diagrams

Straight Leads 5-Lead TO-220 (T) Top View

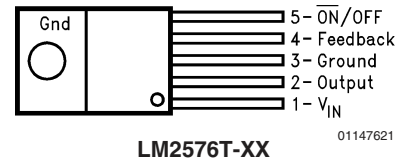

LM2576T-XX
NS Package Number T05A

TO-263 (S) 5-Lead Surface-Mount Package Top View

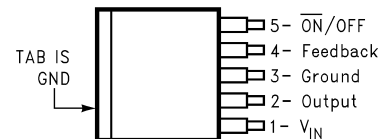

Side View



LM2576S-XX
NS Package Number TS5B
LM2576SX-XX
NS Package Number TS5B, Tape and Reel

Bent, Staggered Leads 5-Lead TO-220 (T) Top View

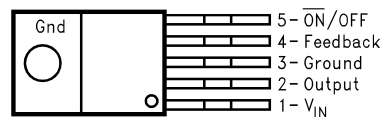

Side View

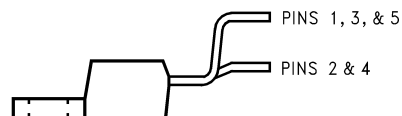

LM2576T-XX Flow LB03
NS Package Number T05D

X-ON Electronics

Largest Supplier of Electrical and Electronic Components

Click to view similar products for [Linear Voltage Regulators](#) category:

Click to view products by [HGSEMI](#) manufacturer:

Other Similar products are found below :

[LV56831P-E](#) [LV5684PVD-XH](#) [MAX202ECWE-LF](#) [MCDTSA6-2R](#) [L4953G](#) [L7815ACV-DG](#) [PQ3DZ53U](#) [LV56801P-E](#)
[TCR3DF13,LM\(CT](#) [TCR3DF39,LM\(CT](#) [TLE42794G](#) [L78L05CZ/1SX](#) [L78LR05DL-MA-E](#) [L78MR05-E](#) [033150D](#) [033151B](#) [090756R](#)
[636416C](#) [NCV78M15BDTG](#) [702482B](#) [714954EB](#) [TLE42794GM](#) [TLE42994GM](#) [ZMR500QFTA](#) [BA033LBSG2-TR](#)
[NCV78M05ABDTRKG](#) [NCV78M08BDTRKG](#) [NCP7808TG](#) [NCV571SN12T1G](#) [LV5680P-E](#) [CAJ24C256YI-GT3](#) [L78M15CV-DG](#) [L9474N](#)
[TLS202B1MBV33HTSA1](#) [L79M05T-E](#) [NCP571SN09T1G](#) [MAX15006AASA/V+](#) [MIC5283-5.0YML-T5](#) [L4969URTR-E](#) [L78LR05D-MA-E](#)
[NCV7808BDTRKG](#) [L9466N](#) [NCP7805ETG](#) [SC7812CTG](#) [NCV7809BTG](#) [NCV571SN09T1G](#) [NCV317MBTG](#) [MC78M15CDTT5G](#)
[MC78M12CDTT5G](#) [L9468N](#)