

2018

产品说明书

PRODUCT MANUAL

深圳市叁叶源主要生产被动元器件 SMD R-Chip 电阻，产品尺寸：0402-1206，阻值范围：1-22 兆欧姆，产品具有高可靠性电极设计、兼容所有焊接制程等特点。

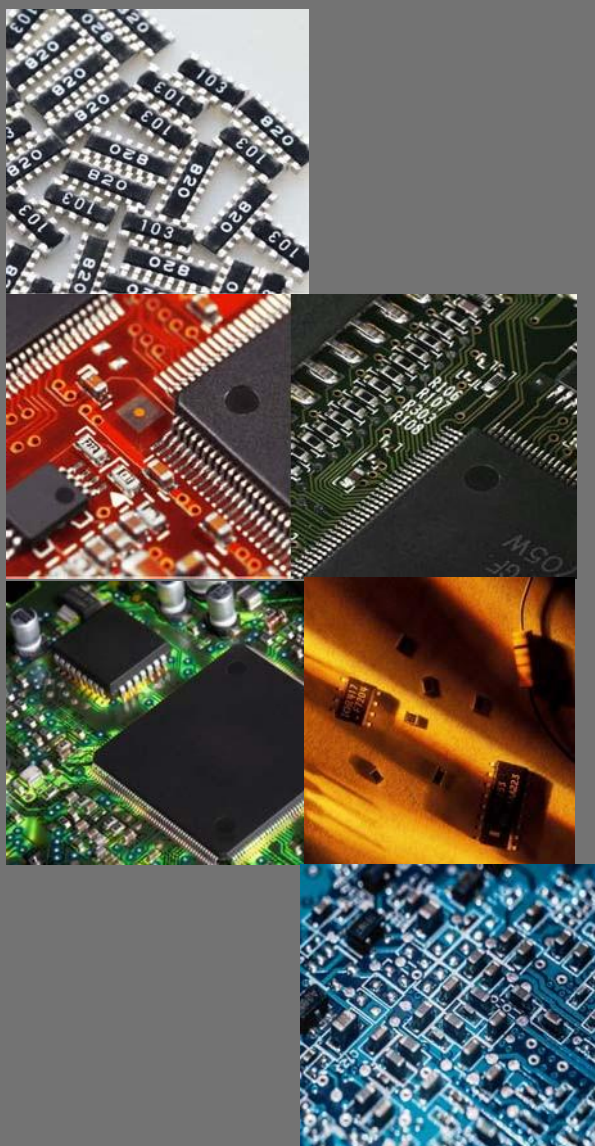

Administrator
深圳市叁叶源电子有限公司
2018/6/1

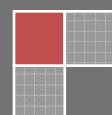

目录

Contents

● 特点 Features	3
● 品名构成 Type Designation	3
● 结构 Construction	4
● 规格尺寸 Dimensions	4
● 负荷下降曲线 Derating Curve	4
● 额定值 Ratings	5
● 常规 TCR 值	5
● 高精度 TCR \pm 50 额定值	6
● 特性 Characteristics	6
● 推荐焊盘尺寸 Recommend Solder Pad Size	9
● 包装 Packaging	9
● IEC E-24、E-96 系列电阻值代码对照表	12
● 厚膜电阻阻值代码及标记规则	14
● 片式电阻器使用说明	16
● 焊接 Soldering	17

■ 常规厚膜片式固定电阻器

General Thick Film Chip Fixed Resistor

● 特点 Features

体积小、重量轻

Miniature and light weight

适应再流焊与波峰焊

Suit for reflow and wave flow solder

电性能稳定，可靠性高

Stable electrical capability, high reliability

装配成本低，并与自动贴装设备匹配

Low assembly cost, suit for automatic SMT equipment

机械强度高，高频特性优越

Superior mechanical and frequency characteristics

符合 RoHS 指令要求

Compliant with RoHS directive

符合无卤素

Halogen free requirement



● 品名构成 Type Designation

Single Chip Resistor

SY **0402** **J** **N** **100R** **P**
(1) **(2)** **(3)** **(4)** **(5)** **(6)**

(1)	(2)	(3)	(4)	(5)	(6)
Series	Size	Resistance Tolerance	TCR	Resistance	Packing style
SY Thinck Film	0402	B=±0.1%	N=Base on Spc	1K	P=Pager Tape
ST Thinck Film	0603	D=±0.5%	E=±50ppm/°C	100K	B=Embossed Plastic
SA Atuomotive Garde	0805	F=±1%	D=±25ppm/°C	10R	
	1206	J=±5%	F=±100ppm/°C	4K7	
			G=±200ppm/°C	1M	

常规厚膜片式固定电阻

GENERAL THICK FILM CHIP FIXED RESISTOR

● 结构 Construction

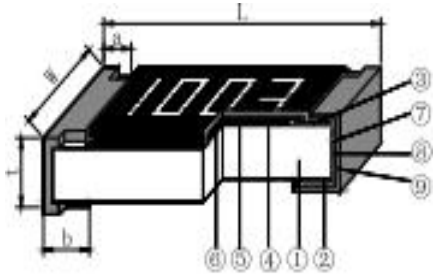

- ①陶瓷基板Ceramic Substrate
- ②背电极Bottom Electrode
- ③面电极Top Electrode
- ④电阻体Resistor Layer
- ⑤一次保护Primary Overcoat
- ⑥二次保护 Secondary Overcoat
- ⑦端电极Edge Electrode
- ⑧中间电极 Barrier Layer
- ⑨外部电极External Electrode

● 规格尺寸Dimensions

型号 Type	尺寸 Dimensions(mm)				
	L	W	t	a	b
0402	1.00±0.10	0.50±0.05	0.35±0.05	0.20±0.10	0.25±0.10
0603	1.60±0.10	0.80±0.10	0.45±0.10	0.30±0.20	0.30±0.20
0805	2.00±0.15	1.25 ^{+0.15} _{-0.10}	0.55±0.10	0.40±0.20	0.40±0.20
1206	3.10±0.15	1.55 ^{+0.15} _{-0.10}	0.55±0.10	0.45±0.20	0.45±0.20

● 负荷下降曲线 Derating Curve

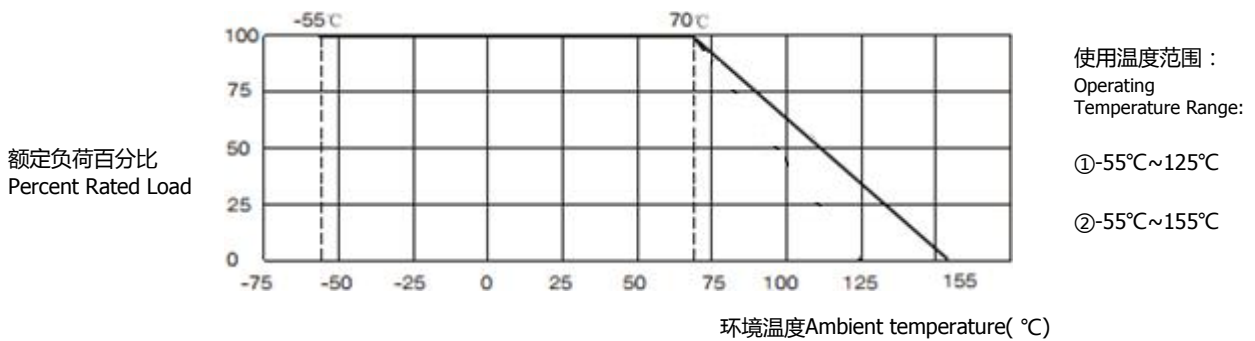

注 1：图中曲线适用于适用于 0402、0603、0805、1206。

Note 1: 0402、0603、0805、1206 be the same with curve .

注 2：当电阻使用的环境温度超过 70°C 时，其额定负荷（额定功率）按上述曲线下降。

Note 2：For resistors operated in ambient over 70°C ,rated load (rated power) shall be derated in accordance with the above figure.

常规厚膜片式固定电阻

GENERAL THICK FILM CHIP FIXED RESISTOR

● 额定值 Ratings

型号 Type	70°C下额定功率 Rated Power at 70°C (W)		组件极限电压 Limiting Element Voltage (V)		最大过负荷电压 Max. Overload Voltage (V)	
	常规功率系列 Normal Power Series	提升功率系列 Upgraded Power Series	常规功率系列 Normal Power Series	提升功率系列 Upgraded Power Series	常规功率系列 Normal Power Series	提升功率系列 Upgraded Power Series
0402	1/16	/	50	/	100	/
0603	1/16	1/10	50	50	100	100
0805	1/10	1/8	100	150	200	300
1206	1/8	1/4	200	200	400	400
注 Note	1、电压为直流或交流有效值 Voltage of DC or AC RMS value 2、 $E = \sqrt{P \times R}$ 或元件极限电压两者中的较小值 $E = \sqrt{P \times R}$ or Limiting element voltage whichever is lower. E: 额定电压 Rated voltage(V) P: 额定功率 Rated power(W) R: 标称阻值 Normal resistance(Ω)					

● 常规TCR值

型号 Type	阻值范围 Resistance Range	电阻温度系数 T.C.R(ppm/ °C)			
		标称阻值允许偏差 Resistance Tolerance			
		±0.5%	±1%	±2%	±5%
0402	$1\Omega < R < 10\Omega$	/	±400	±400	±400
	$10\Omega < R$	±100	±100	±100	±100
0603	$1\Omega < R < 10\Omega$	±400	±400	±400	±400
	$10\Omega < R < 100\Omega$	±200	±200	±200	±200
	$100\Omega < R$	±100	±100	±100	±100
0805	$1\Omega < R < 10\Omega$	±400	±400	±400	±400
1206	$10\Omega < R$	±100	±100	±100	±100

常规厚膜片式固定电阻

GENERAL THICK FILM CHIP FIXED RESISTOR

● 高精度 TCR \pm 50 额定值

型号 Type	阻值范围 Resistance Range	电阻温度系数 T.C.R(ppm/ °C)			
		标称阻值允许偏差 Resistance Tolerance			
		$\pm 0.1\%$	$\pm 0.25\%$	$\pm 0.5\%$	$\pm 1\%$
0402	$100\Omega < R < 1M\Omega$	/	/	± 50	± 50
0603 0805	$10\Omega < R < 1M\Omega$	± 50	± 50	± 50	± 50
1206	$1M\Omega < R < 10M\Omega$	/	± 50	± 50	± 50

● 特性 Characteristics

项目 Item	标准 Specifications	测试方法(IEC 60115-1) Test Methods (IEC 60115-1)
可焊性 Solderability	可焊面积 $\geq 95\%$ 95% Cover Min	IEC 60115-1 4.17 245°C \pm 5°C 锡槽, 保持 2~3s. Lead-free solder bath at 245°C \pm 5°C for 2~3s.
耐焊接热 Resistance to Soldering Heat	无可见损伤 No mechanical damage $\Delta R \leq \pm (1.0\%R + 0.05 \Omega)$	IEC 60115-1 4.18 260°C \pm 5°C 锡槽, 保持 10s \pm 1s. Lead-free solder bath at 260°C \pm 5°C for 10s \pm 1s.
基板弯曲试验 Substrate Bending Test	无可见损伤 No mechanical damage $\Delta R \leq \pm (1.0\%R + 0.05 \Omega)$	IEC 60115-1 4.33 弯曲距离 (Bending distance) : 0402、0603、0805、1206 : 5mm ; 保持时间(Duration): 60s \pm 5s.
电阻温度系数 T.C.R	在规定值内 Within specified T.C.R	IEC 60115-1 4.8 +20°C/-55°C/+20°C/+125°C/+20°C

常规厚膜片式固定电阻

GENERAL THICK FILM CHIP FIXED RESISTOR

● 特性 Characteristics

接上页Continue

项目 Item	标准 Specifications	测试方法(IEC 60115-1) Test Methods (IEC 60115-1)
温度循环 Temperature cycling	无可见损伤 No mechanical damage 0.5%、1% $\Delta R \leq \pm (0.5\%R + 0.05 \Omega)$ 2%、5% $\Delta R \leq \pm (1.0\%R + 0.05 \Omega)$	IEC 60115-1 4.19 0402、0603、0805、1206 : -55±3°C(30 分钟)--常温(10~15 分钟)--155±2°C(30 分钟)--常温(10~15 分钟),1000 个循环. 0402、0603、0805、1206: -55±3°C(30min)--normal temperature(10~15min)--155±2°C(30min)--normal temperature(10~15min),1000 cycles.
短时间过负载 Short Time Overload	无可见损伤 No mechanical damage 0.5%、1% $\Delta R \leq \pm (1.0\%R + 0.1\Omega)$ 2%、5% $\Delta R \leq \pm (2.0\%R + 0.1 \Omega)$	IEC 60115-1 4.13 2.5 倍额定电压或最大过负荷电压(取较小值), 保持 5 秒 2.5 times rated voltage or max. overload voltage whichever is lower for 5 s.
断续过负载 Intermittent Overload	无可见损伤 No mechanical damage $\Delta R \leq \pm (5.0\%R + 0.05 \Omega)$	IEC 60115-1 4.39 2.5 倍额定电压或最大过负荷电压(取较小值), 通 1 秒/断 25 秒, 10000 个循环. 2.5 times rated voltage or max. overload voltage whichever is lower for 1s ON/ 25s OFF ,10000 cycles.
湿度寿命 Load life in humidity	无可见损伤 No mechanical damage 0.5%、1% $\Delta R \leq \pm (0.5\%R + 0.1 \Omega)$ 2%、5% $\Delta R \leq \pm (3.0\%R + 0.1 \Omega)$	IEC 60115-1 4.24 40°C±2°C, 90~95%RH, 1000 小时, 额定电压或元件极限电压(取较小值), 通 1.5 小时/断 0.5 小时. 40°C±2°C,90~95%RH,1000h, rated voltage or limiting element voltage whichever is lower for 1.5h ON/0.5h OFF.
耐溶剂 Component Solvent Resistance	无可见损伤 No mechanical damage $\Delta R \leq \pm (1.0\%R + 0.05 \Omega)$	IEC 60115-1 4.29 浸入异丙醇(IPA),超声波清洗 3 分钟 Specimens shall be immersed in a bath of alcohol completely for a 3 minutes using ultrasonic test equipment

常规厚膜片式固定电阻

GENERAL THICK FILM CHIP FIXED RESISTOR

● 特性 Characteristics

项目 Item	标准 Specifications	测试方法(IEC 60115-1) Test Methods (IEC 60115-1)
负载寿命 Load life	无可见损伤 No mechanical damage 0.5%、1% $\Delta R \leq \pm (1.0\%R + 0.1 \Omega)$ 2%、5% $\Delta R \leq \pm (3.0\%R + 0.1 \Omega)$	IEC 60115-1 4.25.1 70°C±2°C, 1000 小时, 额定电压或元件极限电压(取较小值), 通 1.5 小时/断 0.5 小时. 70°C±2°C, 1000h, rated voltage or limiting element voltage whichever is lower for 1.5h ON/0.5h OFF.
绝缘电阻 Insulation Resistance	$\geq 1000M\Omega$ Min	IEC 60115-1 4.6 在电极与基片间施加 100V 直流电压, 保持 60~70s, 然后测绝缘电 阻值。 Apply DC 100V between substrate and terminations for 1min, then check insulation resistance
耐电压 Voltage Proof	无击穿或飞弧 No breakdown or flashover	IEC 60115-1 4.7 电阻固定在90°C的V型槽中, 根据不同产品规定交流电压, 持续 60~70秒 Resistor shall be clamped in the trough of 90°C metallic V - block and shall be tested at AC potential respectively specified in the given list of each product type for 60-70 seconds. For Cement Fixed Resistors 0402、0603、0805、1206 : 125°C, 1000h.

■ 推荐焊盘尺寸 Recommend Solder Pad Size

- 片式固定电阻器 Chip fixed resistor

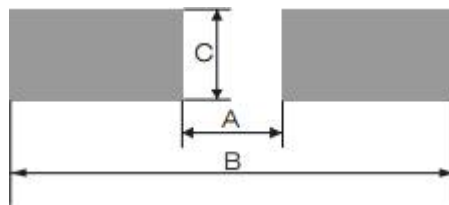

单位unit: mm

厚膜电阻及薄膜电阻
Thick Film Resistor and
Thin Film Resistor

常规厚膜片式固定电阻

GENERAL THICK FILM CHIP FIXED RESISTOR

型号 Type	A	B	C
0402	0.45	1.45	0.60
0603	0.80	2.50	0.95
0805	1.05	3.25	1.40
1206	1.90	4.50	1.75

■ 包装 Packaging

● 纸带编带-1 Paper Taping-1

适用于 0402、

For 0402

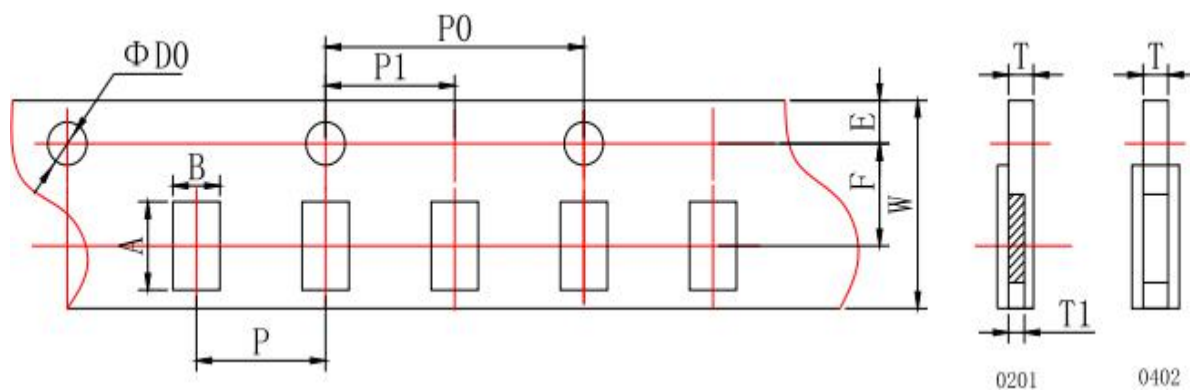

单位unit: mm

型号 Type	A±0.2	B±0.2	W±0.2	F±0.05	E±0.1
0402	1.15	0.65	8.00	3.50	1.75

单位 unit: mm

型号 Type	P±0.05	P0±0.1	P1±0.05	ΦD0+0.1	T1	T±0.1
0402	2.00	4.00	2.00	1.50	/	0.45

● 纸带编带-2 Paper Taping-2

适用于 0603、0805、1206:

For 0603、0805、1206:

常规厚膜片式固定电阻

GENERAL THICK FILM CHIP FIXED RESISTOR

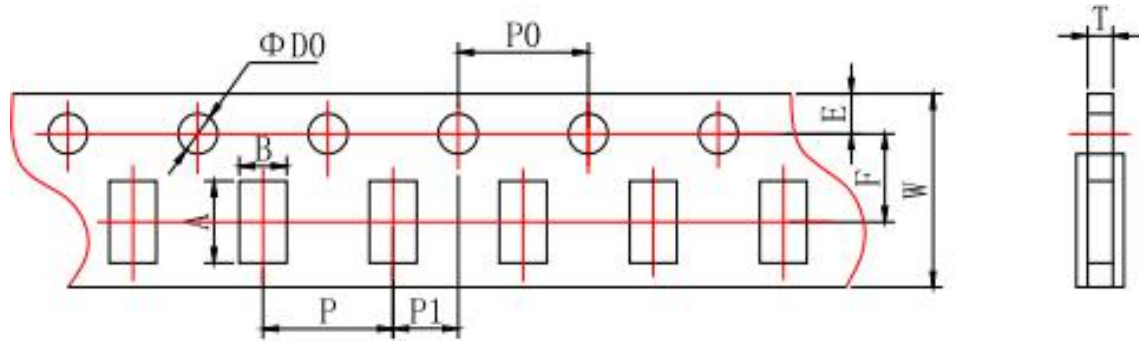

单位unit: mm

型号 Type	$A \pm 0.2$	$B \pm 0.2$	$W \pm 0.2$	$F \pm 0.05$	$E \pm 0.1$
0603	1.90	1.10	8.00	3.50	1.75
0805	2.40	1.65	8.00	3.50	1.75
1206	3.60	2.00	8.00	3.50	1.75

单位unit: mm

型号 Type	$P \pm 0.05$	$P0 \pm 0.1$	$P1 \pm 0.05$	$\Phi D0 \pm 0.1$	$T \pm 0.1$
					厚膜电阻及薄膜电阻 Thick Film Resistor and Thin Film Resistor
0603	2.00	4.00	2.00	1.50	0.67
0805	2.00	4.00	2.00	1.50	0.81
1206	2.00	4.00	2.00	1.50	0.81

常规厚膜片式固定电阻

GENERAL THICK FILM CHIP FIXED RESISTOR

- 卷盘 Reel

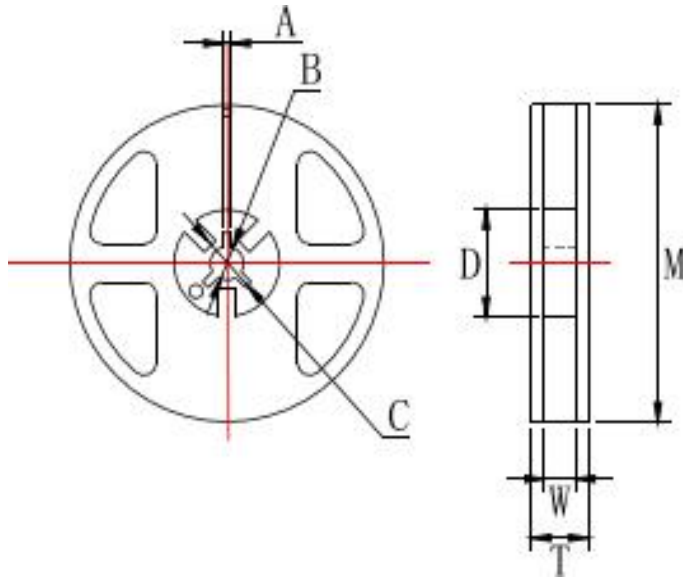

单位unit: mm

型号 Type	M	W	T	A	B	C	D
01005、0201	178±2.0	10±1.0	12.5±1.5	2.0±0.5	13.0±0.5	21.0±0.5	58.0±2.0
0402、0603							
0805、1206							

- 包装数量 Packaging Quantity

包装方法 Packaging style	编带 Tape & reel	
型号 Type	0402	0603、0805、1206
数量 Quantity(pcs)	10000	5000

常规厚膜片式固定电阻

GENERAL THICK FILM CHIP FIXED RESISTOR

■ IEC E-24、E-96 系列电阻值代码对照表

IEC E-24、E-96 Series Resistance Cross-reference List

- E-24 系列 E-24 series($\times 10^n \Omega$)

(单位 unit : 0.001 Ω 、0.01 Ω 、0.1 Ω 、1 Ω 、10 Ω 、100 Ω 、1k Ω 、10k Ω 、100k Ω 、1M Ω 、10M Ω 、100M Ω 、1000M Ω)

1.0	1.5	2.2	3.3	4.7	6.8
1.1	1.6	2.4	3.6	5.1	7.5
1.2	1.8	2.7	3.9	5.6	8.2
1.3	2.0	3.0	4.3	6.2	9.1

- E-96 系列 E-96 series($\times 10^n \Omega$)

(单位 unit : 0.001 Ω 、0.01 Ω 、0.1 Ω 、1 Ω 、10 Ω 、100 Ω 、1k Ω 、10k Ω 、100k Ω 、1M Ω 、10M Ω 、100M Ω 、1000M Ω)

1.00	1.33	1.78	2.37	3.16	4.22	5.62	7.50
1.02	1.37	1.82	2.43	3.24	4.32	5.76	7.68
1.05	1.40	1.87	2.49	3.32	4.42	5.90	7.87
1.07	1.43	1.91	2.55	3.40	4.53	6.04	8.06
1.10	1.47	1.96	2.61	3.48	4.64	6.19	8.25
1.13	1.50	2.00	2.67	3.57	4.75	6.34	8.45
1.15	1.54	2.05	2.74	3.65	4.87	6.49	8.66
1.18	1.58	2.10	2.80	3.74	4.99	6.65	8.87
1.21	1.62	2.15	2.87	3.83	5.11	6.81	9.09
1.24	1.65	2.21	2.94	3.92	5.23	6.98	9.31
1.27	1.69	2.26	3.01	4.02	5.36	7.15	9.53
1.30	1.74	2.32	3.09	4.12	5.49	7.32	9.76

- E-96 系列 0603 型号《乘数代码对照表》

E-96 series(0603) 《multiplied Cross-reference List》

乘数 multiplied	$\times 10^0$	$\times 10^1$	$\times 10^2$	$\times 10^3$	$\times 10^4$	$\times 10^5$	$\times 10^6$	$\times 10^7$	$\times 10^{-1}$	$\times 10^{-2}$	$\times 10^{-3}$
代码 code	A	B	C	D	E	F	G	H	X	Y	Z

常规厚膜片式固定电阻

GENERAL THICK FILM CHIP FIXED RESISTOR

- E-96 系列 0603 型号《电阻值代码对照表》

E-96 series(0603) 《Resistance Cross-reference List》

代号 Code	E-96 系列电阻 E-96 resistance	代号 Code	E-96 系列电阻 E-96 resistance	代号 Code	E-96 系列电阻 E-96 resistance	代号 Code	E-96 系列电阻 E-96 resistance
01	100	25	178	49	316	73	562
02	102	26	182	50	324	74	576
03	105	27	187	51	332	75	590
04	107	28	191	52	340	76	604
05	110	29	196	53	348	77	619
06	113	30	200	54	357	78	634
07	115	31	205	55	365	79	649
08	118	32	210	56	374	80	665
09	121	33	215	57	383	81	681
10	124	34	221	58	392	82	698
11	127	35	226	59	402	83	715
12	130	36	232	60	412	84	732
13	133	37	237	61	422	85	750
14	137	38	243	62	432	86	768
15	140	39	249	63	442	87	787
16	143	40	255	64	453	88	806
17	147	41	261	65	464	89	825
18	150	42	267	66	475	90	845
19	154	43	274	67	487	91	866
20	158	44	280	68	499	92	887
21	162	45	287	69	511	93	909
22	165	46	294	70	523	94	931
23	169	47	301	71	536	95	953
24	174	48	309	72	549	96	976

■ 厚膜电阻阻值代码及标记规则

Description for Resistance Value Code and Marking of Thick Film Chip Resistor

● 阻值代码 Resistance Value Code

所有厚膜电阻的阻值代码与其标记是相对应的

All the resistance value code of thick film chip resistor is corresponding with the marking .

● 标记 Marking

- E-24 系列 (0603、 $\pm 5\%$) : 采用三位数表示, 前二位表示电阻值有效数字, 第三位表示乘以 10 的次方数。

E-24 series: Express resistance value on the glass side with three digits, the first tow digits should be significant and the third one denote number of zeros.

例 For example:  

- E-24 系列 (0603、 $\pm 1\% \& \pm 0.5\%$) : 在三位数字标记下方增加下划线识别

E-24 series(0603 、 $\pm 1\% \& \pm 0.5\%$): One short bar under marking letter.



例 For example:



- E-96 系列和 E24 系列 ($\pm 1\% \& \pm 0.5\%$) :

△ 0805、1206 采用四位数字表示, 前三位表示电阻值有效数字, 第四位表示乘以 10 的次方数。

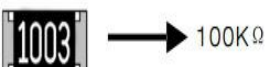
E-96 series & E-24 series: For the dimension type of 0805、1206、1210、2010、2512、4R02 、4R03 express the resistance value with four digits, the first three digits are significant figures and the fourth denotes the number of zeros.

例 For example:  

常规厚膜片式固定电阻

GENERAL THICK FILM CHIP FIXED RESISTOR

- E-96 系列

△ 0603 用三位代码表示，前二位表示 E-96 系列阻值代码，后一位字母表示乘数代码。

For the dimension type of 0603, express the resistance value with three code, the first two digit code denote the resistance of E-96 series, and the third code of letter denote the multiplier.

例 For example:  → 2MΩ

- 小数点以 “R” 表示 The decimal point should be expressed by “R” .

例 For example:  → 5.6Ω  → 1Ω

- 跨接电阻以 “0” 表示 The jumper should be expressed by “0” .

例 For example:  → 0Ω  → 0Ω

- 0402 不作标记

For the dimension type of 0201、0402 there is no mark on the glass side.

例 For example: 

- 非 IEC 标准系列的电阻值标记表示方法：一般以最接近 IEC E24 系列标称阻值的标记表示方法。

For the resistance which don't belong to IEC serial, use the resistance of IEC serial which is most close to the required resistance of non-IEC serial for replacement.

- 客户对标记有特殊要求时，则按照协商的结果印刷标记。

To get agreement by both party if there special requirement for the marking.

■ 片式电阻器使用说明 Chip Resistor Instructions for Use

- 本产品以下特殊环境下应用，性能可能会受到影响：
 - 1、在各种类型的液体，包括水、油、化学品、有机溶剂的使用。
 - 2、在户外直接暴露在阳光的地方，或在灰尘多的地方使用。
 - 3、在产品暴露的地方，有海风或腐蚀性气体，包括氯气、硫化氢、氨气、二氧化硫、二氧化氮等。
 - 4、在产品暴露于静电或电磁波的地方使用。
 - 5、在产生热量的部件、塑料线或其它易燃物品附近使用。
 - 6、在用树脂或其他涂层材料密封产品的情况下使用。
 - 7、焊接后使用不洁焊料或使用水或水溶性清洗剂清洗产品。
- Application of the products in a special environment can deteriorate product performance:
 - 1、 Use in various types of liquid, including water, oils, chemicals, and organic solvents.
 - 2、 Use outdoors where the products are exposed to direct sunlight, or in dusty places.
 - 3、 Use in places where the products are exposed to sea winds or corrosive gases, including Cl₂, H₂S, NH₃, SO₂, and NO₂ etc.
 - 4、 Use in places where the products are exposed to static electricity or electromagnetic waves.
 - 5、 Use in proximity to heat-producing components, plastic cords, or other flammable items.
 - 6、 Use involving sealing or coating the products with resin or other coating materials.
 - 7、 Use involving unclean solder or use of water or water-soluble cleaning agents for cleaning after soldering.
- 产品使用注意事项
 - 1、避免采用超过正常额定功率的功率，超过额定功率的稳能负载条件下可能会对产品性能和可靠性产生负面影响。
 - 2、用镊子拿起产品时要小心，有可能会将保护或电阻体夹碎。
 - 3、手动安装产品时，烙铁头勿触碰产品。
 - 4、储存条件：温度 5°C~30°C，相对湿度 30%~70%。

● Precautions on use of products

- 1、 Avoid applying power exceeding normal rated power, exceeding the power rating under steady-state loading condition may negatively affect product performance and reliability.
- 2、 Be careful when pick up the products with tweezers. There may be a care that the overcoat or the body can be chipped.
- 3、 Soldering tip shall not touch the product when install product manually.
- 4、 Storage conditions: T : 5°C~30°C , RH : 30% ~70%.

■ 焊接 Soldering

- 推荐的回流焊曲线 Recommended reflow profile

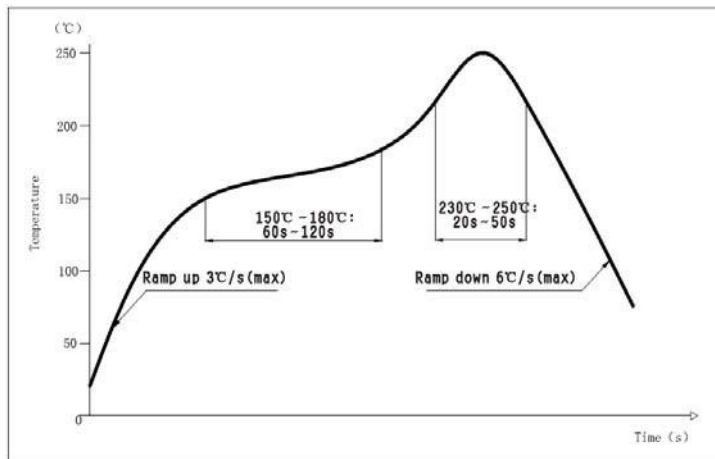

- 推荐的波峰焊曲线 Recommended wave solder profile

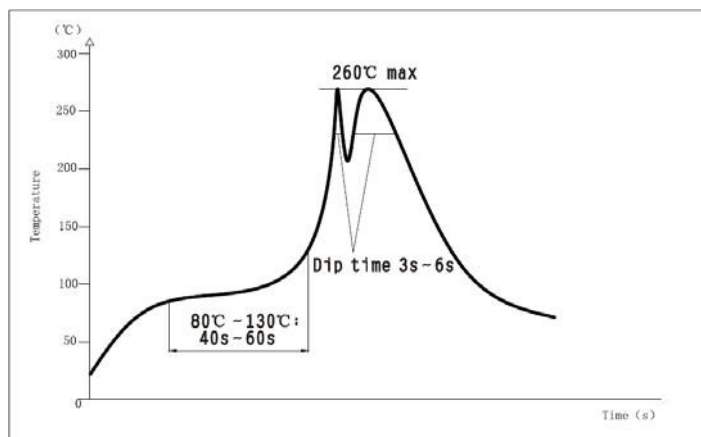

- 推荐的焊膏类型 Recommended solder alloy : 96.5 Sn/3.0 Ag/0.5Cu

X-ON Electronics

Largest Supplier of Electrical and Electronic Components

Click to view similar products for [Thick Film Resistors](#) category:

Click to view products by [SANYEAR](#) manufacturer:

Other Similar products are found below :

[MCR03EZPFX3162](#) [MCR004YZPJ332](#) [201007J022KT4E](#) [201007F1653T4E](#) [201007F6652T4E](#) [0603WAF137KT5E](#) [RTT204702FTE](#)
[RTT203000FTE](#) [RTT2056R0FTE](#) [CR2010F470KE04Z](#) [RTT018451FTH](#) [RTT021802DTH](#) [0402WGF510LTCE](#) [0201WMJ0200TEE](#)
[TR0603B26K7P0550Z](#) [0201WMF5102TEE](#) [1210W2J047KT5E](#) [YLR12-2-4F-W](#) [HOT\(0.25x1.3\)-3.2-0R-I](#) [HOT\(0.4x1.5\)-5.2-0R-I](#)
[HoT\(0.45x1.5\)-8.2-0R-I](#) [0201WMF1103TEE](#) [0201WMF7152TEE](#) [1210W2J0124T5E](#) [201007J010LT4E](#) [201007J0360T4E](#) [201007J0430T4E](#)
[0805W8F931KT5E](#) [1206W4F5231T5E](#) [1210W2J0620T5E](#) [201007J0822T4E](#) [0201WMF1005TCE](#) [0201WMF1212TCE](#) [0201WMF1373TCE](#)
[0201WMF1400TCE](#) [0201WMF2000TEE](#) [0201WMF2001TCE](#) [0201WMF226JTCE](#) [0201WMF2672TCE](#) [0201WMF2803TCE](#)
[0201WMF357JTCE](#) [0201WMF3743TCE](#) [0201WMF430JTCE](#) [0201WMF4990TCE](#) [0201WMF5104TCE](#) [0201WMF510JTEE](#)
[0201WMF5110TCE](#) [0201WMF6652TEE](#) [0201WMF6812TCE](#) [0201WMF8200TCE](#)