

2018

产品说明书

PRODUCT MANUAL

THICK FILM CHIP RESISTOR FOR LED

Resistance range: $1\Omega\sim 10M\Omega$

CL series

5% 1%

Sizes 0805/1206

深圳市叁叶源电子主要生产被动元器件 SMD R-Chip 电阻,产品具有高可靠性电极设计、兼容所有焊接制程等特点。



目录

Contents

● 特点 Features	3
● 品名构成 Type Designation	3
● 结构 Construction	4
● 规格尺寸 Dimensions	4
● 负荷下降曲线 Derating Curve	4
● 额定值 Ratings	5
● TCR 值	5
● 特性 Characteristics	5
● 推荐焊盘尺寸 Recommend Solder Pad Size	8
● 包装 Packaging	8
● IEC E-24、E-96 系列电阻值代码对照表	9
● 厚膜电阻阻值代码及标记规则	10
● 片式电阻器使用说明	11
● 焊接 Soldering	13

■ LED 软灯带厚膜片式电阻

Thick Film Chip Resistor For LED

● 特点 Features

体积小、重量轻

Miniature and light weight

适应再流焊与波峰焊

Suitable for reflow and wave flow solder

电性能稳定，可靠性高

Stable electrical capability, high reliability

装配成本低，并与自动贴装设备匹配

Low assembly cost, suitable for automatic SMT equipment

机械强度高，高频特性优越

Superior mechanical and frequency characteristics

符合RoHS 指令要求

Compliant with RoHS directive

符合无卤素

Halogen free compliant

● 品名构成 Type Designation

Single Chip Resistor

SY LE08 J N 100R P XX
 05



(1)	(2)	(3)	(4)	(5)	(6)	(7)
Series Name	Size	Resistance Tolerance	T C R	Resistance	Packing style	Special
SY Thick Film	LE0805	F=±1%	N=Base on Spc	E-24 Series	P=Paper Tape	
ST Thin Film	LE1206	J=±5%	E=±50ppm/'c	E-48 Series	B=Embossed Plastic	
SA Automotive Grade			D=±25ppm/'c	E-96 Series		
SF Low Ohmic			F=±100ppm/'c			
			G=±200ppm/'c			
			H=±600ppm/'c			

LED 软灯带厚膜片式电阻

THICK FILM CHIP RESISTOR FOR LED

● 结构 Construction

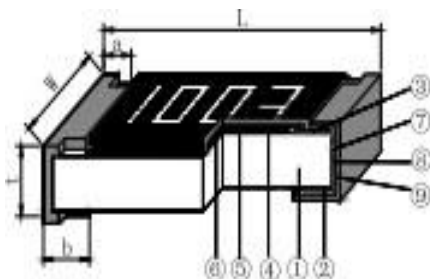

- ①陶瓷基板 Ceramic Substrate
- ②背电极 Bottom Electrode
- ③面电极 Top Electrode
- ④电阻体 Resistor Layer
- ⑤一次保护 Primary Overcoat
- ⑥二次保护 Secondary Overcoat
- ⑦端电极 Edge Electrode
- ⑧中间电极 Barrier Layer
- ⑨外部电极 External Electrode

● 规格尺寸 Dimensions

型号 Type	尺寸 Dimensions(mm)				
	L	W	t	a	b
LE0805	2.00±0.20	1.25±0.15	0.50±0.10	0.30±0.20	0.40±0.20
LE1206	3.20±0.20	1.60±0.15	0.55±0.10	0.50±0.20	0.50±0.20

● 负荷下降曲线 Derating Curve

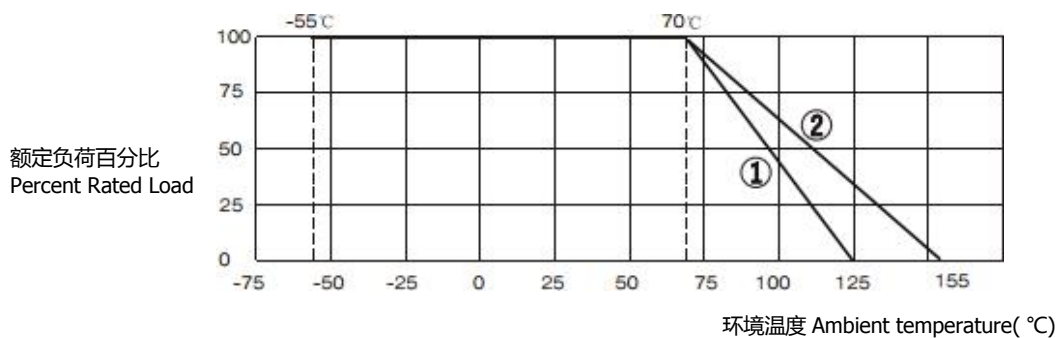

注 1:曲线②适用于 LE0805、LE1206产品。 Note 1:

LE0805、LE1206 be the same with curve② .

注 2：当电阻使用的环境温度超过 70°C时，其额定负荷（额定功率）按上述曲线下降。

Note 2 : For resistors operated in ambient over 70°C ,rated load (rated power) shall be derated in accordance with the above derating curve.

LED 软灯带厚膜片式电阻

THICK FILM CHIP RESISTOR FOR LED

● 额定值 Ratings

型式 Type	定格功率 Rated power	最高使用电压 Maximum working voltage	最高过负荷电压 Maximum overload voltage	耐电压 Dielectric Withstanding Voltage	阻值范围 (Ω) Resistance Range (Ω)		
					±0.1%	±0.25%	±0.5%
LE0805	1/8W	150V	300V	300V	±1%	±2%	±5%, ±10%
LE1206	1/4W	200V	400V	500V	1Ω~1MΩ		

备注：①以上表格中最高使用电压：按照公式 $E=\sqrt{(P \times R)}$ 计算出最高工作电压；当计算的电压小于表-1 中最高使用电压时，以计算的电压为准；当计算的电压大于表-1 中最高使用电压时，以表-1 中最高使用电压为准。

①Note: In the above table top use voltage: according to the formula $E = \sqrt{(P \times R)}$ calculated the highest working voltage, When calculating the voltage is less than form -1 in the highest use voltage, standard as the voltage calculated, When calculating the voltage is greater than the highest voltage of form - 1, standard as highest voltage of form -1 .

②超出表格规定阻值 10MΩ 以上，如客户有需求时必须提供相关参数参考，以利测试。

② Beyond the form specified value 10M Ω above, such as customer demand to provide related reference, in order to test.

● TCR 值

型号 Type	阻值范围 Resistance Range	电阻温度系数 T.C.R(ppm/ °C)					
		标称阻值允许偏差 Resistance Tolerance					
		±0.1%	±0.25%	±0.5%	±1%	±5%	±10%
LE0805 LE1206	1Ω~10Ω	/	/	/	±200		
	10Ω~1MΩ	±100					
	1MΩ~10MΩ	/	±100				

● 特性 Characteristics

项目 Item	标准 Specifications	测试方法(IEC 60115-1) Test Methods (IEC 60115-1)
可焊性 Solderability	可焊面积≥95% 95% Cover Min	IEC 60115-1 4.17 245°C±5°C 锡槽，保持 3s±0.3s. Lead-free solder bath at 245°C±5°C for 3s±0.3s.

LED 软灯带厚膜片式电阻

THICK FILM CHIP RESISTOR FOR LED

耐焊接热 Resistance to Soldering Heat	无可见损伤 No mechanical damage $\Delta R \leq \pm (1.0\%R + 0.05 \Omega)$	IEC 60115-1 4.18 270°C±5°C 锡槽, 保持 10s±1s. Lead-free solder bath at 270°C±5°C for 10s±1s.
基板弯曲试验 Substrate Bending Test	无可见损伤 No mechanical damage $\Delta R \leq \pm (1.0\%R + 0.05 \Omega)$	IEC 60115-1 4.33 弯曲距离(Bending distance): LE0805: 5mm; LE1206: 4mm; 保持时间(Duration):60s±5s.
剪切力试验 Shear Test	外观无可见损伤 No mechanical damage	IEC 60115-1 4.32 施加力(Applying force): LE0805: 9N; LE1206: 25N; 保持时间(Duration):10s±1s.
电阻温度系数 T.C.R	在规定值内 Within specified T.C.R	IEC 60115-1 4.8 +20°C/-55°C/+20°C/+125°C/+20°C

● 特性 Characteristics

接上页 Continue

项目 Item	标准 Specifications	测试方法(IEC 60115-1) Test Methods (IEC 60115-1)
温度快速变化 Rapid Change of Temperature	0.1%、0.25%、0.5%、1% $\Delta R \leq \pm (0.5\%R + 0.05 \Omega)$ 5%、10% $\Delta R \leq \pm (1.0\%R + 0.05 \Omega)$	LE0805、LE1206:-55°C(30分钟)--常温(5分钟)--155°C(30分钟),300个循环。 LE0805、LE1206: -55°C(30min)--normal temperature(5min)-- 155°C(30min),300 cycles.
短时间过负载 Short Time Overload	0.1%、0.25%、0.5%、1% $\Delta R \leq \pm (1.0\%R + 0.05 \Omega)$ 5%、10% $\Delta R \leq \pm (2.0\%R + 0.05 \Omega)$	IEC 60115-1 4.13 2.5 倍额定电压或最大过负荷电压(取较小值), 保持 5 秒 2.5 times rated voltage or max. overload voltage whichever is lower for 5 s.
断续过负载 Intermittent Overload	无可见损伤 No mechanical damage $\Delta R \leq \pm (5.0\%R + 0.05 \Omega)$	IEC 60115-1 4.39 2.5 倍额定电压或最大过负荷电压(取较小值), 通 1 秒/断 25 秒, 10000 个循环。 2.5 times rated voltage or max. overload voltage whichever is lower for 1s ON/ 25s OFF ,10000 cycles.
稳能湿热 Damp Heat, Steady State	0.1%、0.25%、0.5%、1% $\Delta R \leq \pm (1.0\%R + 0.05 \Omega)$ 5%、10% $\Delta R \leq \pm (2.0\%R + 0.05 \Omega)$	IEC 60115-1 4.24 40°C±2°C, 93%±3%RH, 1000 小时, 额定电压或元件极限电压(取较小值), 通 1.5 小时 / 断 0.5 小时。 40°C±2°C,93%±3%RH,1000h, rated voltage or limiting element voltage whichever is lower for 1.5h ON/0.5h OFF.

LED 软灯带厚膜片式电阻

THICK FILM CHIP RESISTOR FOR LED

耐溶剂 Component Solvent Resistance	无可见损伤 No mechanical damage $\Delta R \leq \pm (1.0\%R + 0.05 \Omega)$	IEC 60115-1 4.29 异丙醇(IPA), 23°C±5°C, 浸 10 小时 Iso-propyl alcohol (IPA), 23°C±5°C, 10h.
---	---	---

● 特性 Characteristics

接上页 Continue

项目 Item	标准 Specifications	测试方法(IEC 60115-1) Test Methods (IEC 60115-1)
70°C耐久性 Endurance at 70°C	0.1%、0.25%、0.5%、1% $\Delta R \leq \pm (1.0\%R + 0.05 \Omega)$ 5%、10% $\Delta R \leq \pm (2.0\%R + 0.05 \Omega)$	IEC 60115-1 4.25.1 70°C±2°C, 1000 小时, 额定电压或元件极限电压(取较小值), 通 1.5 小时/断 0.5 小时. 70°C±2°C, 1000h, rated voltage or limiting element voltage whichever is lower for 1.5h ON/0.5h OFF.
上限类别温度 耐久性 Endurance at Upper Category Temperature	0.1%、0.25%、0.5%、1% $\Delta R \leq \pm (1.0\%R + 0.05 \Omega)$ 5%、10% $\Delta R \leq \pm (2.0\%R + 0.05 \Omega)$	IEC 60115-1 4.25.3 LE0805、LE1206 : 155°C±2°C, 1000h.
低温负载 Operation at Low Temperature	0.1%、0.25%、0.5%、1% $\Delta R \leq \pm (1.0\%R + 0.05 \Omega)$ 5%、10% $\Delta R \leq \pm (2.0\%R + 0.05 \Omega)$	IEC 60115-1 4.36 -55°C±5°C, 无负载 1 小时, 额定电压或元件极限电压(取较小值)45 分钟, 无负载 15 分钟 -55°C±5°C, 1h without load rated voltage or limiting element voltage whichever is lower for 45min, 15min without load.
绝缘电阻 Insulation Resistance	1000MΩ Min	IEC 60115-1 4.6 在电极与基片间施加 100V±15V 直流电压, 保持 1 分钟, 然后测绝 缘电阻值。 Apply DC 100V 15V between substrate and terminations for 1min, then check insulation resistance
耐电压 Voltage Proof	无击穿或飞弧 No breakdown or flashover	IEC 60115-1 4.7 在电极与基片间以大约 100V/s 的速率施加有效值为最大过负荷电压 的交流电压, 保持 60s±5s Apply max. overload voltage of AC RMS at a rate of approximately 100V/s between substrate and terminations for 60s±5s.

LED 软灯带厚膜片式电阻

THICK FILM CHIP RESISTOR FOR LED

■ 推荐焊盘尺寸 Recommend Solder Pad Size

- 片式固定电阻器 Chip fixed resistor

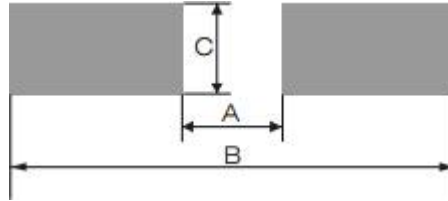

单位 unit: mm

低阻厚膜电阻 LOW OHMIC			
型号 Type	A	B	C
LE0805	1.05	3.25	1.40
LE1206	1.90	4.50	1.75

■ 包装 Packaging

● 纸带尺寸 Tape Specification

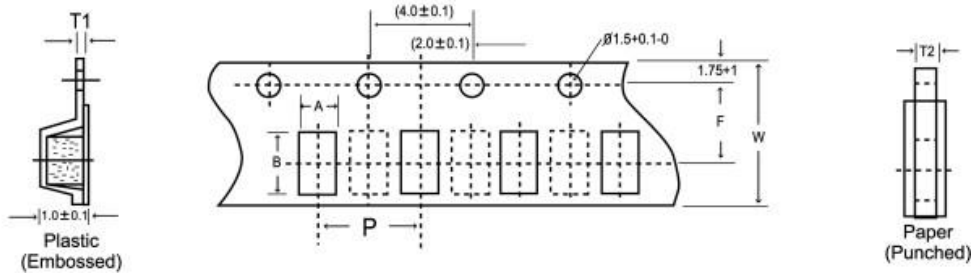

Size Code	A	B	W	F	T1	T2	P
LE0805	1.65±0.2	2.40±0.2	8.0±0.2	3.5±0.05	/	0.75±0.1	4.0±0.05
LE1206	2.00±0.2	3.60±0.2	8.0±0.2	3.5±0.05	/	0.75±0.1	4.0±0.05

LED 软灯带厚膜片式电阻

THICK FILM CHIP RESISTOR FOR LED

- 卷盘 Reel

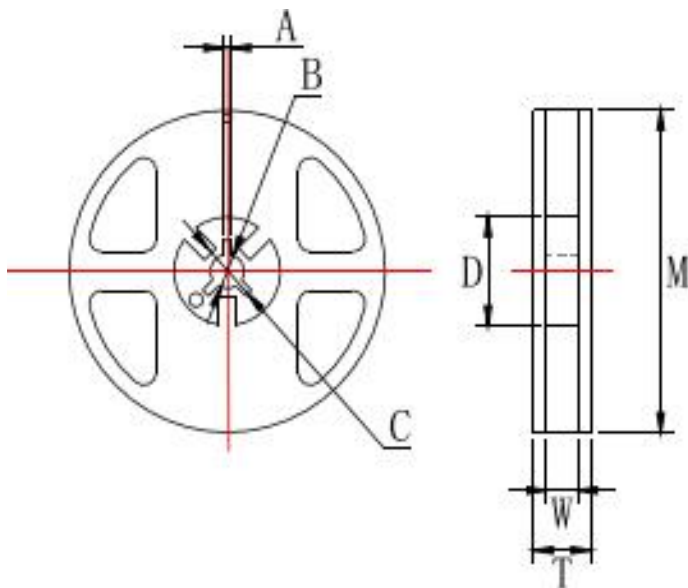

单位 unit: mm

型号 Type	M	W	T	A	B	C	D
LE0805、LE1206	178±2.0	9.5±1.0	12.5±1.5	2.0±0.5	13.0±0.5	21.0±0.5	58.0±2.0

- 包装数量 Packaging Quantity

包装方法 Packaging style	编带 Tape & reel	塑料袋散装 Case
型号 Type	LE0805 LE1206	LE0805 LE1206
数量 Quantity(pcs)	5000	≤10000

■ IEC E-24、E-96 系列电阻值代码对照表

IEC E-24、E-96 Series Resistance Cross-reference List

- E-24 系列 E-24 series($\times 10^n \Omega$)

(单位 unit : 0.001 Ω 、0.01 Ω 、0.1 Ω 、1 Ω 、10 Ω 、100 Ω 、1k Ω 、10k Ω 、100k Ω 、1M Ω 、10M Ω 、100M Ω 、1000M Ω)

1.0	1.5	2.2	3.3	4.7	6.8
1.1	1.6	2.4	3.6	5.1	7.5
1.2	1.8	2.7	3.9	5.6	8.2
1.3	2.0	3.0	4.3	6.2	9.1

LED 软灯带厚膜片式电阻

THICK FILM CHIP RESISTOR FOR LED

- E-96 系列 E-96 series($\times 10^n \Omega$)

(单位 unit : 0.001 Ω 、0.01 Ω 、0.1 Ω 、1 Ω 、10 Ω 、100 Ω 、1k Ω 、10k Ω 、100k Ω 、1M Ω 、10M Ω 、100M Ω 、1000M Ω)

1.00	1.33	1.78	2.37	3.16	4.22	5.62	7.50
1.02	1.37	1.82	2.43	3.24	4.32	5.76	7.68
1.05	1.40	1.87	2.49	3.32	4.42	5.90	7.87
1.07	1.43	1.91	2.55	3.40	4.53	6.04	8.06
1.10	1.47	1.96	2.61	3.48	4.64	6.19	8.25
1.13	1.50	2.00	2.67	3.57	4.75	6.34	8.45
1.15	1.54	2.05	2.74	3.65	4.87	6.49	8.66
1.18	1.58	2.10	2.80	3.74	4.99	6.65	8.87
1.21	1.62	2.15	2.87	3.83	5.11	6.81	9.09
1.24	1.65	2.21	2.94	3.92	5.23	6.98	9.31
1.27	1.69	2.26	3.01	4.02	5.36	7.15	9.53
1.30	1.74	2.32	3.09	4.12	5.49	7.32	9.76

■ 厚膜电阻阻值代码及标记规则

Description for Resistance Value Code and Marking of Thick Film Chip Resistor

- 阻值代码 Resistance Value Code

所有厚膜电阻的阻值代码与其标记是相对应的

All the resistance value code of thick film chip resistor is corresponding with the marking .

- 标记 Marking

- E-24 系列 (LE0805/LE1206、 $\pm 5\%$) : 用三位数表示, 前二位表示阻值有效数字, 第三位表示乘以 10 的次方数。

E-24 series: Express resistance value on the glass side with three digits, the first tow digits should be significant and the third one denote number of zeros.

例 For example:

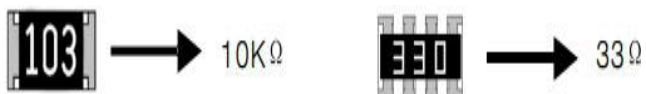

LED 软灯带厚膜片式电阻

THICK FILM CHIP RESISTOR FOR LED

- E-96 系列和 E24 系列 ($\pm 1\%$ & $\pm 0.5\%$) :

△ LE0805、LE1206 采用四位数字表示，前三位表示电阻值有效数字，第四位表示乘以 10 的次方数。E-96 series & E-24 series: For the dimension type of LE0805、LE1206 express the resistance value with four digits, the first three digits are significant figures and the fourth denotes the number of zeros.

例 For example:



- 非 IEC 标准系列的电阻值标记表示方法：一般以最接近 IEC E24 系列标称阻值的标记表示方法。

For the resistance which don't belong to IEC serial, use the resistance of IEC serial which is most close to the required resistance of non-IEC serial for replacement.

- 客户对标记有特殊要求时，则按照协商的结果印刷标记。

To get agreement by both party if there special requirement for the marking.

■ 片式电阻器使用说明 Chip Resistor Instructions for Use

- 本产品在以下特殊环境下应用，性能可能会受到影响：

- 1、在各种类型的液体，包括水、油、化学品、有机溶剂的使用。
- 2、在户外直接暴露在阳光的地方，或在灰尘多的地方使用。
- 3、在产品暴露的地方，有海风或腐蚀性气体，包括氯气、硫化氢、氨气、二氧化硫、二氧化氮等。
- 4、在产品暴露于静电或电磁波的地方使用。
- 5、在产生热量的部件、塑料线或其它易燃物品附近使用。
- 6、在用树脂或其他涂层材料密封产品的情况下使用。
- 7、焊接后使用不洁焊料或使用水或水溶性清洗剂清洗产品。

- Application of the products in a special environment can deteriorate product performance:
 - 1、 Use in various types of liquid, including water, oils, chemicals, and organic solvents.
 - 2、 Use outdoors where the products are exposed to direct sunlight, or in dusty places.
 - 3、 Use in places where the products are exposed to sea winds or corrosive gases, including Cl₂, H₂S, NH₃, SO₂, and NO₂ etc.
 - 4、 Use in places where the products are exposed to static electricity or electromagnetic waves.
 - 5、 Use in proximity to heat-producing components, plastic cords, or other flammable items.
 - 6、 Use involving sealing or coating the products with resin or other coating materials.
 - 7、 Use involving unclean solder or use of water or water-soluble cleaning agents for cleaning after soldering.
- 产品使用注意事项
 - 1、 避免采用超过正常额定功率的功率，超过额定功率的稳态负载条件下可能会对产品性能和可靠性产生负面影响。
 - 2、 用镊子拿起产品时要小心，有可能会将保护或电阻体夹碎。
 - 3、 手动安装产品时，烙铁头勿触碰产品。
 - 4、 储存条件：温度 5°C~30°C，相对湿度 30%~70%。
- Precautions on use of products
 - 1、 Avoid applying power exceeding normal rated power, exceeding the power rating under steady-state loading condition may negatively affect product performance and reliability.
 - 2、 Be careful when pick up the products with tweezers. There may be a care that the overcoat or the body can be chipped.
 - 3、 Soldering tip shall not touch the product when install product manually.
 - 4、 Storage conditions: T : 5°C~30°C , RH : 30% ~70%.

■ 焊接 Soldering

- 推荐的回流焊曲线 Recommended reflow profile

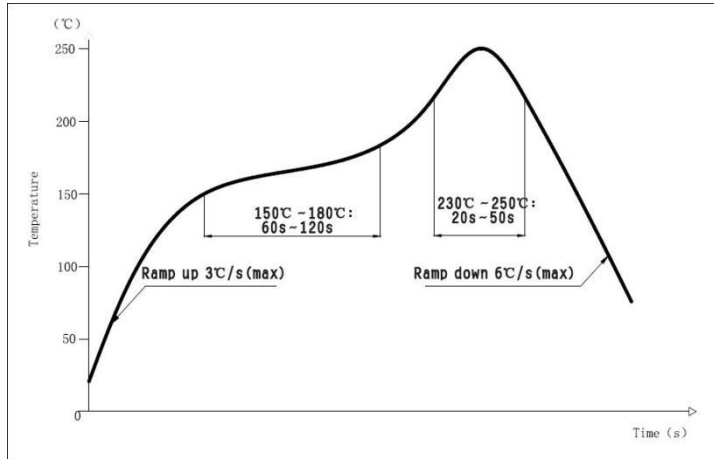

- 推荐的波峰焊曲线 Recommended wave solder profile

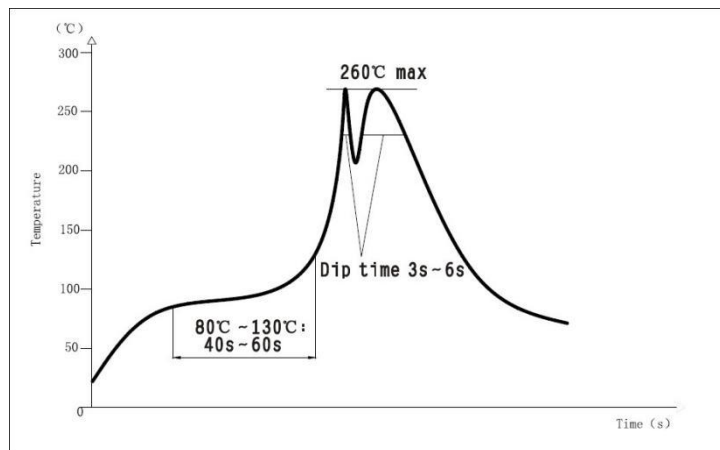

- 推荐的焊膏类型 Recommended solder alloy : 96.5 Sn/3.0 Ag/0.5Cu

X-ON Electronics

Largest Supplier of Electrical and Electronic Components

Click to view similar products for [Thick Film Resistors](#) category:

Click to view products by [SANYEAR](#) manufacturer:

Other Similar products are found below :

[MCR03EZPFX3162](#) [MCR004YZPJ332](#) [201007J022KT4E](#) [201007F1653T4E](#) [201007F6652T4E](#) [0603WAF137KT5E](#) [RTT204702FTE](#)
[RTT203000FTE](#) [RTT2056R0FTE](#) [CR2010F470KE04Z](#) [RTT018451FTH](#) [RTT021802DTH](#) [0402WGF510LTCE](#) [0201WMJ0200TEE](#)
[TR0603B26K7P0550Z](#) [0201WMF5102TEE](#) [1210W2J047KT5E](#) [YLR12-2-4F-W](#) [HOT\(0.25x1.3\)-3.2-0R-I](#) [HOT\(0.4x1.5\)-5.2-0R-I](#)
[HoT\(0.45x1.5\)-8.2-0R-I](#) [0201WMF1103TEE](#) [0201WMF7152TEE](#) [1210W2J0124T5E](#) [201007J010LT4E](#) [201007J0360T4E](#) [201007J0430T4E](#)
[0805W8F931KT5E](#) [1206W4F5231T5E](#) [1210W2J0620T5E](#) [201007J0822T4E](#) [0201WMF1005TCE](#) [0201WMF1212TCE](#) [0201WMF1373TCE](#)
[0201WMF1400TCE](#) [0201WMF2000TEE](#) [0201WMF2001TCE](#) [0201WMF226JTCE](#) [0201WMF2672TCE](#) [0201WMF2803TCE](#)
[0201WMF357JTCE](#) [0201WMF3743TCE](#) [0201WMF430JTCE](#) [0201WMF4990TCE](#) [0201WMF5104TCE](#) [0201WMF510JTEE](#)
[0201WMF5110TCE](#) [0201WMF6652TEE](#) [0201WMF6812TCE](#) [0201WMF8200TCE](#)