

GENERAL DESCRIPTION

The PT4119E is a continuous conduction mode inductive step-down converter, designed for driving single or multiple series connected LED efficiently from a voltage source higher than the total LED chain voltage. The device operates from an input supply between 6V and 50V and provides an externally adjustable output current of up to 1A.

The PT4119E includes the power switch and a high-side output current sensing circuit, which uses an external resistor to set the nominal average output current, and a dedicated DIM input accepts either a DC voltage or a wide range of pulsed dimming. Applying a voltage of 0.3V or lower to the DIM pin turns the output off and switches the device into a low current standby state.

The PT4119E is available in SOT89-5 package.

FEATURES

- Simple low parts count
- Wide input voltage range: 6V to 50V
- High efficiency (up to 97%)
- Up to 1A output current
- Single pin on/off and brightness control using DC voltage or PWM
- Up to 1MHz switching frequency
- Typical 3% output current accuracy
- Inherent open-circuit LED protection
- Inherent Rcs open protection
- High-Side Current Sense
- Hysteretic Control: No need compensation
- Adjustable Constant LED Current
- Thermal shutdown

APPLICATIONS

- Low voltage halogen replacement LEDs
- Automotive lighting
- Low voltage industrial lighting
- LED back-up lighting
- Illuminated signs
- SELV lighting
- LCD TV backlighting

ORDERING INFORMATION

PACKAGE	TEMPERATURE RANGE	ORDERING PART NUMBER	TRANSPORT MEDIA	MARKING
SOT89-5	-40 °C to 85 °C	PT4119EE89E	Tape and Reel 1000 units	 PT4119E xxxxxX

Note:



TYPICAL APPLICATION CIRCUIT

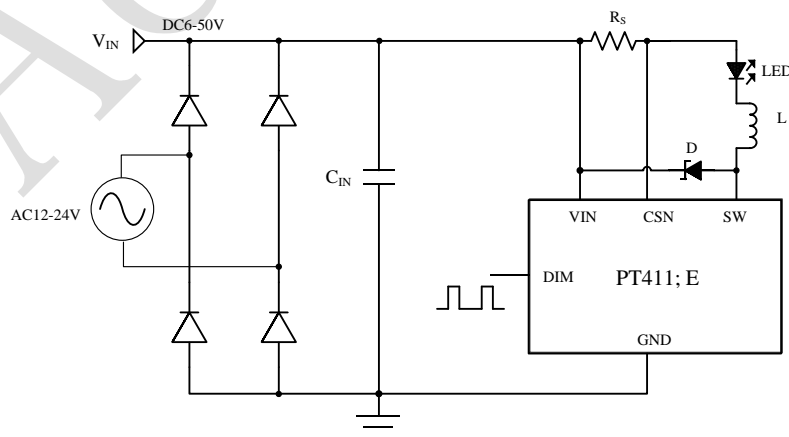

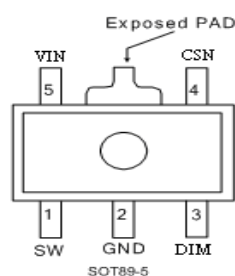
PIN ASSIGNMENT

PIN DESCRIPTIONS

SOT89-5 PIN No.	PIN NAMES	DESCRIPTION
1	SW	Switch Output. SW is the drain of the internal N-Ch MOSFET switch.
2	GND	Signal and power ground. Connect directly to ground plane.
3	DIM	Logic level dimming input. Drive DIM low to turn off the current regulator. Drive DIM high to enable the current regulator.
4	CSN	Current sense input
5	VIN	Input Supply Pin. Must be locally bypassed.
	Exposed PAD	Internally connected to GND. Mount on board for lower thermal resistance.

ABSOLUTE MAXIMUM RATINGS (note1)

SYMBOL	ITEMS	VALUE	UNIT
V_{IN}	Supply Voltage	-0.3~55	V
SW	Drain of the internal power switch	-0.3~55	V
CSN	Current sense input (Respect to VIN)	+0.3~(-6.0)	V
DIM	Logic level dimming input	-0.3~6	V
I_{SW}	Switch output current	1	A
P_{DMAX}	Power Dissipation (Note 2)	1.5	W
P_{TR}	Thermal Resistance, SOT89-5 θ_{JA}	45	°C /W
T_J	Operation Junction Temperature Range	-40 to 150	°C
T_{STG}	Storage Temperature	-55 to 150	°C
	ESD Susceptibility (Note 3)	2	kV

RECOMMENDED OPERATING RANGE

SYMBOL	ITEMS	VALUE	UNIT
V _{IN}	V _{DD} Supply Voltage	6 ~ 50	V
T _{OPT}	Operating Temperature	-40 to +85	°C

Note 1: Absolute Maximum Ratings indicate limits beyond which damage to the device may occur. Recommended Operating Range indicates conditions for which the device is functional, but do not guarantee specific performance limits. Electrical Characteristics state DC and AC electrical specifications under particular test conditions which guarantee specific performance limits. This assumes that the device is within the Operating Range. Specifications are not guaranteed for parameters where no limit is given, however, the typical value is a good indication of device performance.

Note 2: The maximum power dissipation must be derated at elevated temperatures and is dictated by T_{JMAX}, θ_{JA}, and the ambient temperature T_A. The maximum allowable power dissipation is P_{DMAX} = (T_{JMAX} - T_A) / θ_{JA} or the number given in Absolute Maximum Ratings, whichever is lower.

Note 3: Human body model, 100pF discharged through a 1.5kΩ resistor.

Advanced

ELECTRICAL CHARACTERISTICS (Note 4, 5)

 The following specifications apply for $V_{IN}=24V$, $T_A=25^\circ C$, unless specified otherwise.

SYMBOL	ITEMS	CONDITIONS	Min.	Typ.	Max.	UNIT
V_{IN}	Input Voltage		6		50	V
V_{UVLO}	Under voltage lock out	V_{IN} rising		4.5		V
V_{UVLO_HYS}	UVLO hysteresis	V_{IN} falling		0.3		V
F_{SW}	Max. Switching Frequency				1	MHz
Current Sense						
V_{CSN}	Mean current sense threshold voltage	$V_{IN}-V_{CSN}$	194	200	206	mV
V_{CSN_hys}	Sense threshold hysteresis			+15		%
I_{CSN}	CSN Pin Input Current	$V_{IN}-V_{CSN}=50mV$		8		μA
Operating Current						
I_{SD}	Shutdown supply current			60	100	μA
I_{OFF}	Quiescent supply current with output off	No Switching		0.16	0.3	mA
DIM Input						
V_{DIM}	Internal supply voltage	DIM floating		4.2		V
V_{DIM_H}	DIM input voltage High			0.3	0.35	V
V_{DIM_HYS}	DIM input voltage hysteresis		20	50	80	mV
V_{DIM_DC}	DC brightness control		0.5		2.5	V
F_{DIM_MIN}	Min. DIM Frequency			0.1		kHz
F_{DIM_MAX}	Max. DIM Frequency			20		kHz
R_{DIM}	DIM pull up resistor to Internal supply voltage			200		K Ω
I_{DIM_H}	DIM input leakage high	$V_{DIM} = 5.0V$		2.8		μA
I_{DIM_L}	DIM input leakage low	$V_{DIM} = 0$		22		μA
Output Switch						
R_{SW}	SW On Resistance	$V_{IN}=6V\sim 50V$		0.6		Ω
$I_{SW\text{mean}}$	Continuous SW Current				1	A
I_{LEAK}	SW Leakage Current			0.5	5	μA
Thermal Shutdown						
T_{SD}	Thermal Shutdown Threshold			155		$^\circ C$
T_{SD_HYS}	Thermal Shutdown hysteresis			20		$^\circ C$

Note 4: Typical parameters are measured at $25^\circ C$ and represent the parametric norm.

Note 5: Datasheet min/max specification limits are guaranteed by design, test, or statistical analysis.

SIMPLIFIED BLOCK DIAGRAM

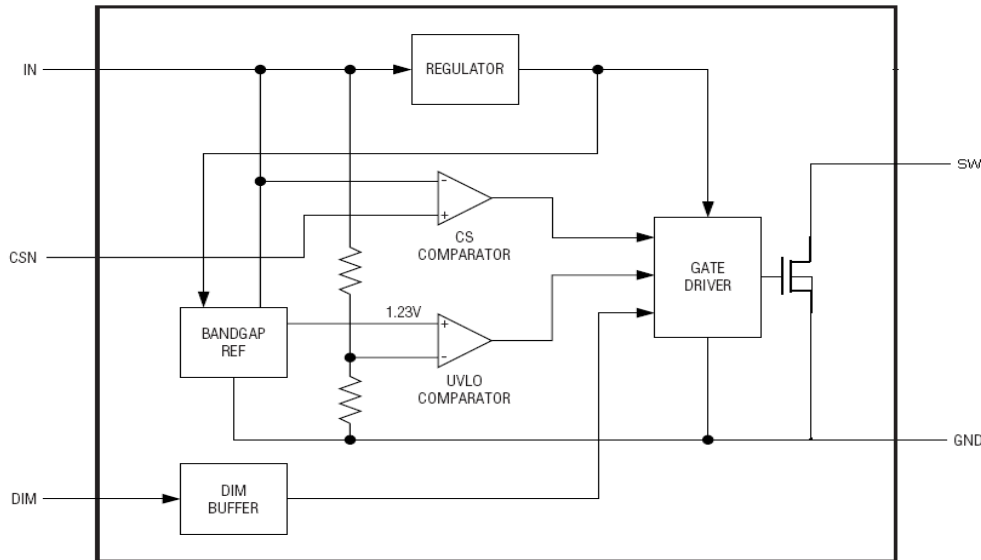

OPERATION DESCRIPTION

The PT4119E in conjunction with current sense resistor (R_{CS}), the inductor ($L1$), and MOSFET forms a self oscillating continuous-mode buck converter.

When input voltage V_{IN} is first applied, the initial current in $L1$ and R_{CS} is zero and there is no output from the current sense circuit. Under this condition, the output of CS comparator is high. This turns on switch, causing current to flow from V_{IN} to ground, via R_{CS} , the LED(s), $L1$ and internal MOSFET. The current rises at a rate determined by V_{IN} and $L1$ to produce a voltage ramp (V_{CSN}) across R_{CS} . When $(V_{IN} - V_{CSN}) > 230\text{mV}$, the output of CS comparator switches low and the switch turns off. The current flowing on the R_{CS} decreases at another rate. When $(V_{IN} - V_{CSN}) < 170\text{mV}$, the switch turns on again and the mean current on the LED is determined by $200\text{mV}/R_{CS}$.

The high-side current-sensing scheme and

on-board current-setting circuitry minimize the number of external components while delivering LED current with $\pm 3\%$ accuracy, using a 1% sense resistor. The PT4119E allows dimming with a PWM signal at the DIM input. A logic level below 0.3V at DIM forces PT4119E to turn off the LED and the logic level at DIM must be at least 2.5V to turn on the full LED current. The frequency of PWM dimming ranges from 100Hz to 20 kHz.

The DIM pin can be driven by an external DC voltage (V_{DIM}) to adjust the output current to a value below the nominal average value defined by R_{CS} . The DC voltage is valid from 0.5V to 2.5V. When the DC voltage is higher than 2.5V, the output current keeps constant.

Additionally, to ensure the reliability, the PT4119E is built with a thermal shutdown (TSD) protection. The TSD protects the IC from over temperature (155°C).

TYPICAL PERFORMANCE CHARACTERISTICS

$V_{IN}=24V, 3LEDs, I_{OUT}=1A, T_A=25^{\circ}C$, unless otherwise noted.

Efficiency

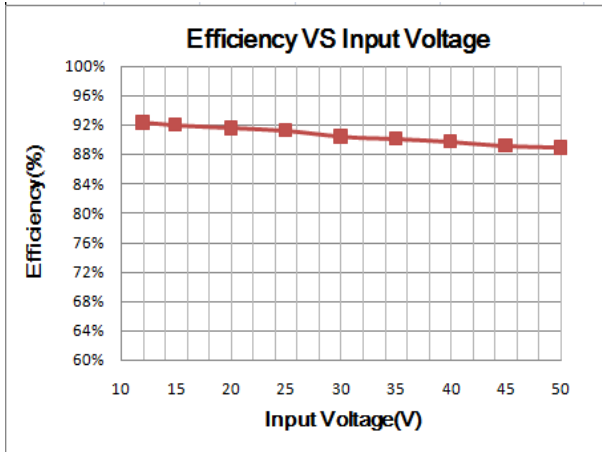

Steady State

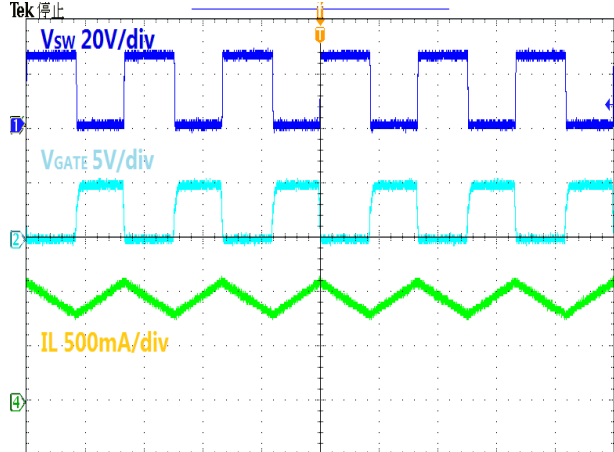

Input Power On

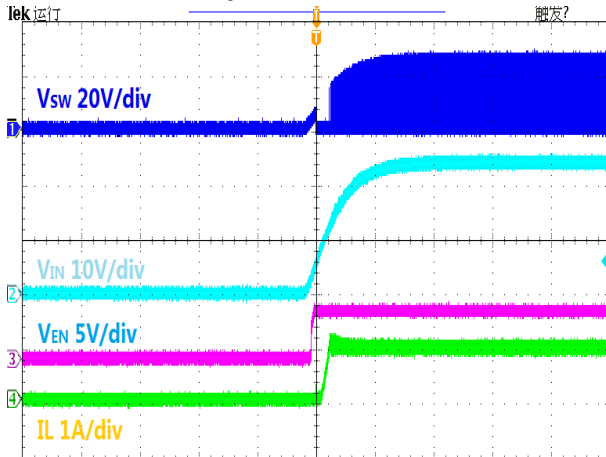

Input Power Off

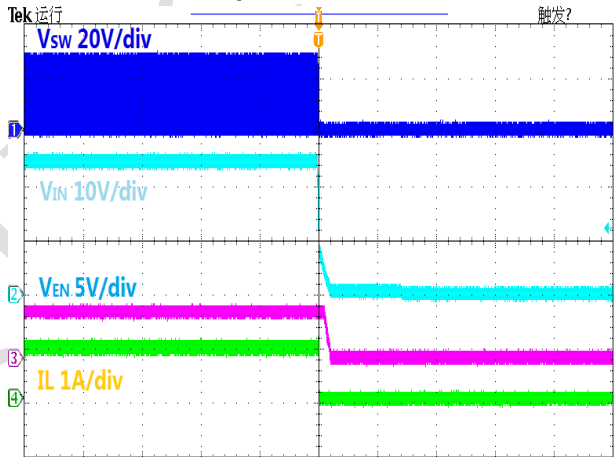

EN Power On

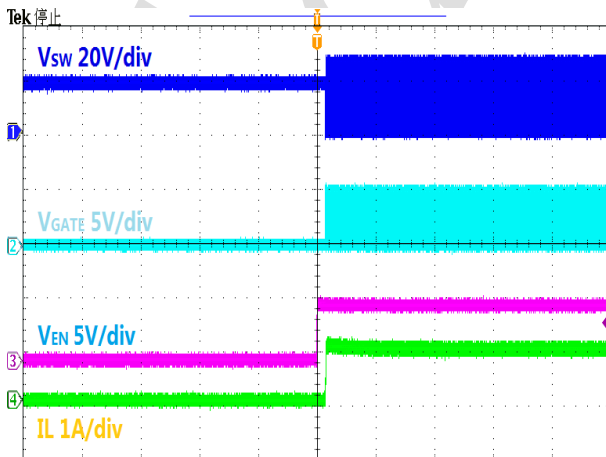

EN Power Off

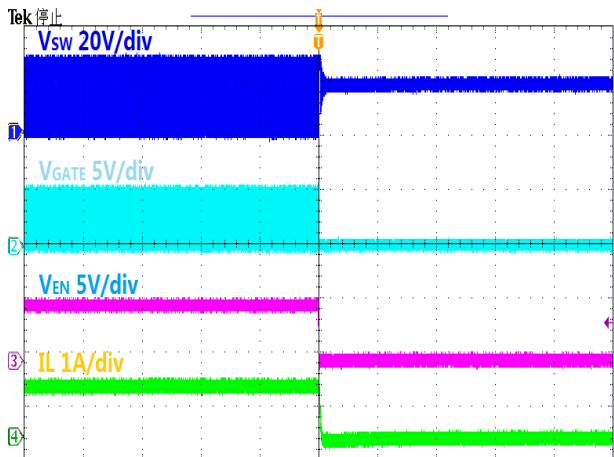

TYPICAL PERFORMANCE CHARACTERASTICS(continued)

$V_{IN}=24V, 3LEDs, I_{OUT}=1A, T_A=25^{\circ}C$, unless otherwise noted.

PWM Dimming
(2KHz,50%)

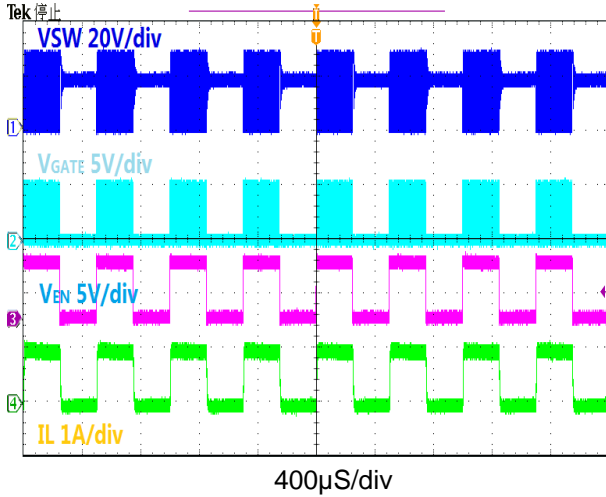

PWM Dimming
(2KHz,1%)

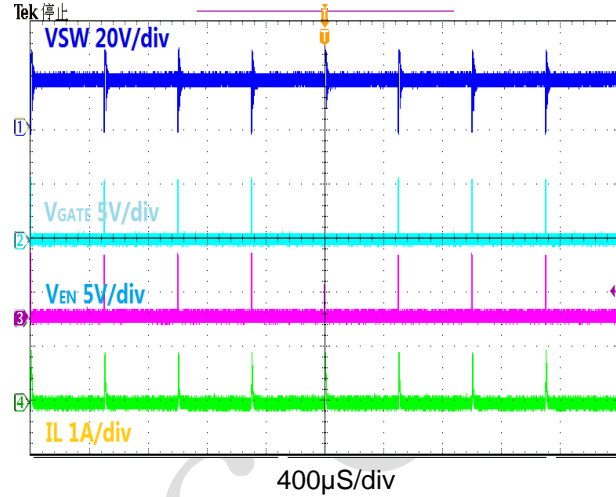

Short LED+ to LED- Protection

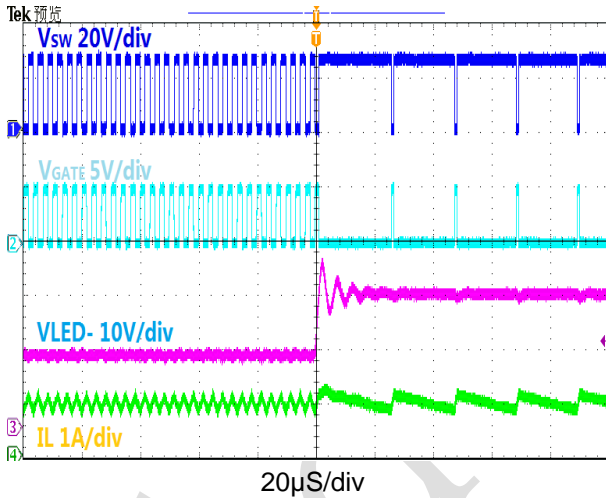

Short LED+ to LED- Recovery

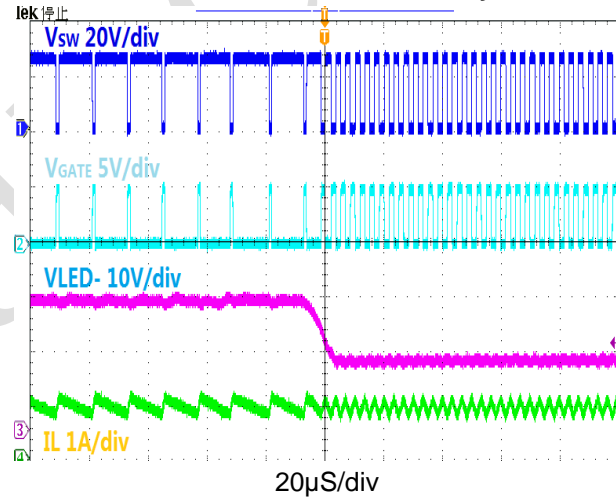

Open LED Load Protection

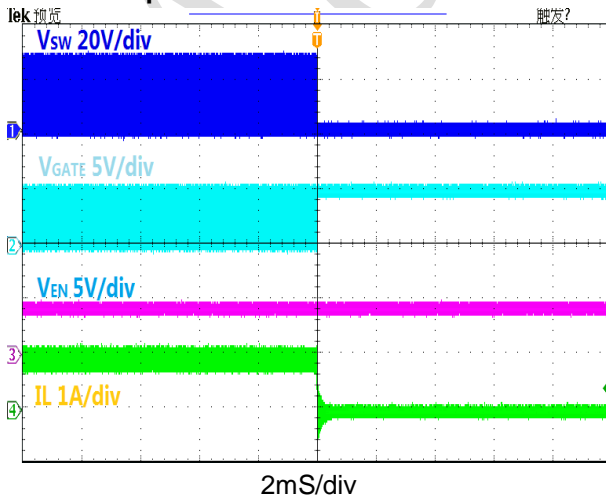

Open LED Load Recovery

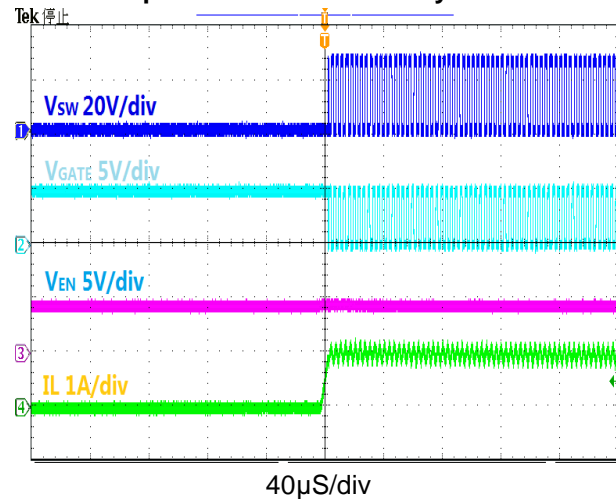

TYPICAL PERFORMANCE CHARACTERISTICS(continued)

$V_{IN}=24V, 3LEDs, I_{OUT}=1A, T_A=25^{\circ}C$, unless otherwise noted.

Open R_{CS} Protection

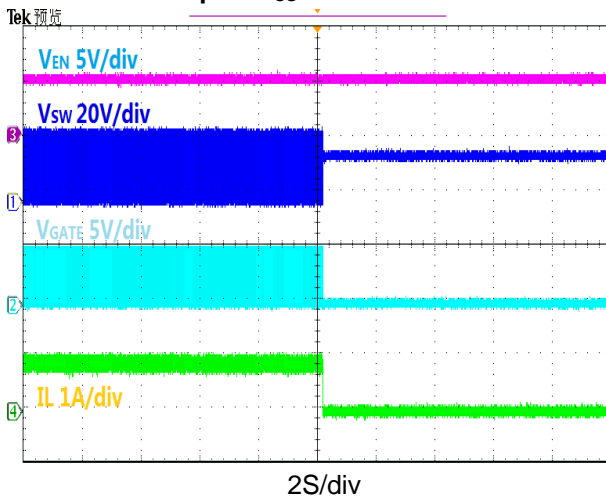

APPLICATION NOTES

Setting nominal average output current with external resistor R_{CS}

The nominal average output current in the LED(s) is determined by the value of the external current sense resistor (R_{CS}) connected between V_{IN} and CSN and is given by:

$$I_{OUT} = 0.2 / R_{CS}$$

This equation is valid when DIM pin is float or applied with a voltage higher than 2.5V (must be less than 5V). Actually, R_{CS} sets the maximum average current which can be adjusted to a less one by dimming.

Output current adjustment by external DC control voltage

The DIM pin can be driven by an external DC voltage (V_{DIM}), to adjust the output current to a value below the nominal average value defined by R_{CS} . The average output current is given by:

$$I_{OUT} = \frac{0.2 \times V_{DIM}}{2.5 \times R_{CS}} \quad (0.5V \leq V_{DIM} \leq 2.5V)$$

Note that 100% brightness setting corresponds to: $(2.5V \leq V_{DIM} \leq 5V)$

Output current adjustment by PWM control

A Pulse Width Modulated (PWM) signal with duty cycle PWM can be applied to the DIM pin, to adjust the output current to a value below the nominal average value set by resistor R_{CS} :

$$I_{OUT} = \frac{0.2 \times D}{R_{CS}}$$

$$(0 \leq D \leq 100\%, 2.5V < V_{PULSE} < 5.0V)$$

$$I_{OUT} = \frac{0.2 \times D \times V_{PULSE}}{2.5 \times R_{CS}}$$

$$(0 \leq D \leq 100\%, 0 < V_{PULSE} < 2.5V)$$

PWM dimming provides reduced brightness by modulating the LED's forward current between 0% and 100%. The LED brightness is controlled by adjusting the relative ratios of the on time to the off time. A 25% brightness level is achieved by turning the LED on at full current for 25% of one cycle. To ensure this switching process between on and off state is invisible by human eyes, the switching frequency must be greater than 100 Hz. Above 100 Hz, the human eyes average the on and off times,

seeing only an effective brightness that is proportional to the LED's on-time duty cycle. The advantage of PWM dimming is that the forward current is always constant, therefore the LED color does not vary with brightness as it does with analog dimming. Pulsing the current provides precise brightness control while preserving the color purity. The dimming frequency of PT4119E can be as high as 20 kHz.

Soft-start

An external capacitor from the DIM pin to ground will provide additional soft-start delay, by increasing the time taken for the voltage on this pin to rise to the turn-on threshold and by slowing down the rate of rise of the control voltage at the input of the comparator.

Input capacitor selection

A low ESR capacitor should be used for input decoupling, as the ESR of this capacitor appears in series with the supply source impedance and lowers overall efficiency. This capacitor has to supply the relatively high peak current to the coil and smooth the current ripple on the input supply. A minimum value of 10 μ F is acceptable if the DC input source is close to the device, but higher values will improve performance at lower input voltages, especially when the source impedance is high. The voltage rating should be greater than the input voltage. The input capacitor should be placed as close as possible to the IC. For maximum stability over temperature and voltage, capacitors with X7R, X5R, or better dielectric are recommended. Capacitors with Y5V dielectric are not suitable for decoupling in this application and should not be used.

Inductor selection

Lower value of inductance can result in a higher switching frequency, which causes a larger

switching loss. Choose a switch frequency between 100kHz to 500kHz for most application. According to switching frequency, inductor value can be estimated as:

$$L = \frac{(1 - V_{OUT}/V_{IN}) \times V_{OUT}}{0.3 \times I_{LED} \times f_{SW}}$$

For higher efficiency, choose an inductor with a DC resistance as small as possible.

Output capacitor selection

For most applications, the output capacitor is not necessary. Peak to peak ripple current in the LED(s) can be reduced below 30% of the average current, if required, by adding a capacitor across the LED(s). A value of 2.2 μ F will meet most requirements. Proportionally lower ripple can be achieved with higher capacitor values. Note that the capacitor will not affect operating frequency or efficiency, but it will increase start-up delay and reduce the frequency of dimming, by reducing the rate of rise of LED voltage.

Thermal considerations

When the device operates at high ambient temperature, or when driving maximum load current, care must be taken to avoid exceeding the package power dissipation limits.

Layout considerations

Pay careful attention to the PCB layout and component placement. Rcs should be placed close to the VIN pin and CSN pin in order to minimize current sense error. The input loop including input capacitor, Schottky diode, and MOSFET which should be as short as possible.

PACKAGE INFORMATION

SOT89-5 Package

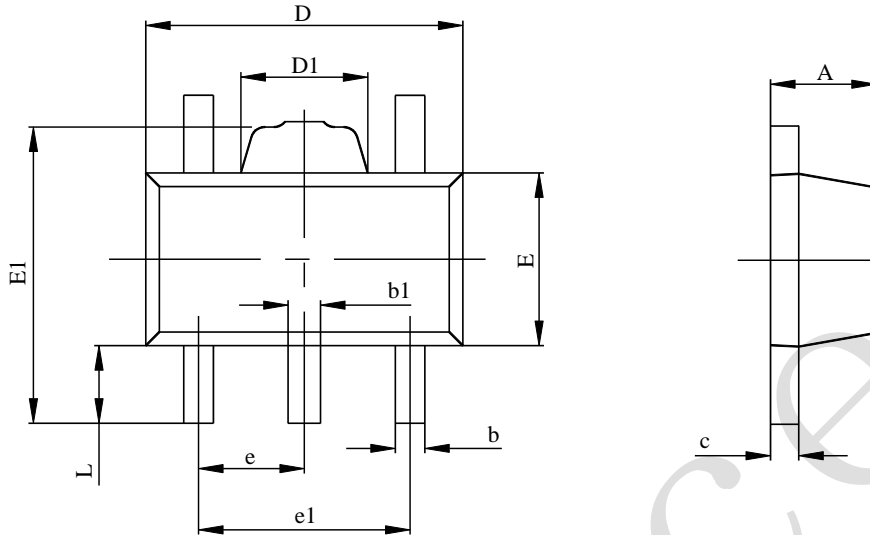

SYMBOL	MILLIMETERS		INCHES	
	MIN	MAX	MIN	MAX
A	1.400	1.600	0.055	0.063
b	0.320	0.520	0.013	0.020
b1	0.360	0.560	0.014	0.022
c	0.350	0.440	0.014	0.017
D	4.400	4.600	0.173	0.181
D1	1.400	1.800	0.055	0.071
E	2.300	2.600	0.091	0.102
E1	3.940	4.250	0.155	0.167
e	1.500 TYP.		0.060 TYP.	
e1	2.900	3.100	0.114	0.122
L	0.900	1.100	0.035	0.043

IMPORTANT NOTICE

POWTECH (SHANGHAI) CO., LTD. reserves the right to make corrections, enhancements, improvements and other changes to its semiconductor products and services and to discontinue any product or service. Buyers should obtain the latest relevant information before placing orders and should verify that such information is current and complete. All semiconductor products (also referred to herein as “components”) are sold subject to POWTECH’s terms and conditions of sale supplied at the time of order acknowledgment.

POWTECH warrants performance of its components to the specifications applicable at the time of sale, in accordance with the warranty in POWTECH’s terms and conditions of sale of semiconductor products. Testing and other quality control techniques are used to the extent POWTECH deems necessary to support this warranty. Except where mandated by applicable law, testing of all parameters of each component is not necessarily performed.

POWTECH assumes no liability for applications assistance or the design of Buyers’ products. Buyers are responsible for their products and applications using POWTECH components. To minimize the risks associated with Buyers’ products and applications, Buyers should provide adequate design and operating safeguards.

No POWTECH components are authorized for use in FDA Class III (or similar life-critical medical equipment) unless authorized officers of the parties have executed a special agreement specifically governing such use.

Only those POWTECH components which POWTECH has specifically designated as military grade or “enhanced plastic” are designed and intended for use in military/aerospace applications or environments. Buyer acknowledges and agrees that any military or aerospace use of POWTECH components which have not been so designated is solely at the Buyer’s risk, and that Buyer is solely responsible for compliance with all legal and regulatory requirements in connection with such use.

Unless POWTECH has specifically designated certain components which meet ISO/TS16949 requirements, mainly for automotive use, POWTECH will not be responsible for any failure of such components to meet such requirements.

Advanced

X-ON Electronics

Largest Supplier of Electrical and Electronic Components

Click to view similar products for [LED Display Drivers](#) category:

Click to view products by [CR-PowTech](#) manufacturer:

Other Similar products are found below :

[MAP9000QNRH](#) [AP5726WUG-7](#) [AL8806QMP-13](#) [AP5726FDCG-7](#) [AS3693B-ZTQT](#) [AP5725WUG-7](#) [MAX139EQH+D](#) [STP16DP05PTR](#)
[STP16CPP05PTR](#) [STP16CPP05XTTR](#) [LV5236VZ-TLM-H](#) [BP9911CC](#) [ZXLD1366QEN8TC](#) [MT7725D](#) [TX6143](#) [SY6813PEC](#) [SD1002L4](#)
[AW3643CSR](#) [MP3370GN-Z](#) [LA2284L-G09-T](#) [SEDA](#) [SCT2027CSSG](#) [LYT3315D](#) [LYT3324D](#) [LYT4211E2](#) [LYT4214E2](#) [LYT4215E2](#)
[LYT4217E2](#) [LYT4218E2](#) [LYT4222E](#) [LYT4317E2](#) [LYT4321E](#) [LYT4323E](#) [LYT4324E3](#) [LYT4326E3](#) [TPS92020DR](#) [TPS92691PWPR](#)
[BCR420U](#) [HV9801ALG-G](#) [IS31FL3199-QFLS2-TR](#) [IS31FL3731-QFLS2-TR](#) [CAT4238TD](#) [SCT2001ASIG](#) [SCT2024CSSG](#) [SCT2024CSTG](#)
[SCT2167CSOG](#) [SCT2167CSSG](#) [STP16CPPS05XTTR](#) [TLE4241GMFUMA1](#) [ICM7212MIQH+D](#)