

技术指标:

1. 塑件表面应光洁、无毛边、无明显收缩、缺陷、裂纹等现象。
2. 温度范围: -25°C~85°C。
3. 额定电压: 50V, AC/DC(等效)。
4. 接触电阻: $\leq 0.03\Omega$ 。
5. 绝缘电阻: $\geq 500M\Omega$ 。
6. 产品料号:

NO OF CKT (产品PIN数)
 XW05200-***
 0: 端子全雾锡
 1: 端子全金(G/F OVERALL)
 2: 端子半金锡
 R: TAPE & REEL 卷装
 T: TUBE管装
 Packing (包装方式)

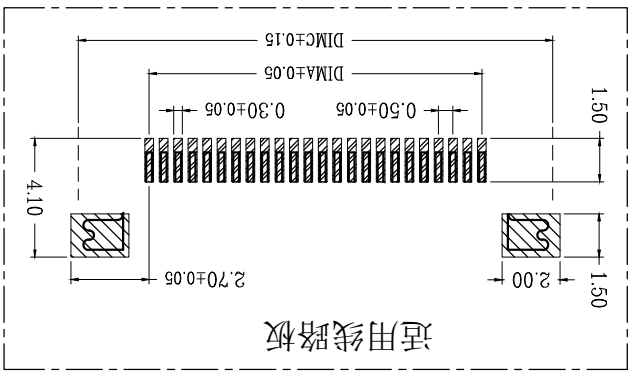
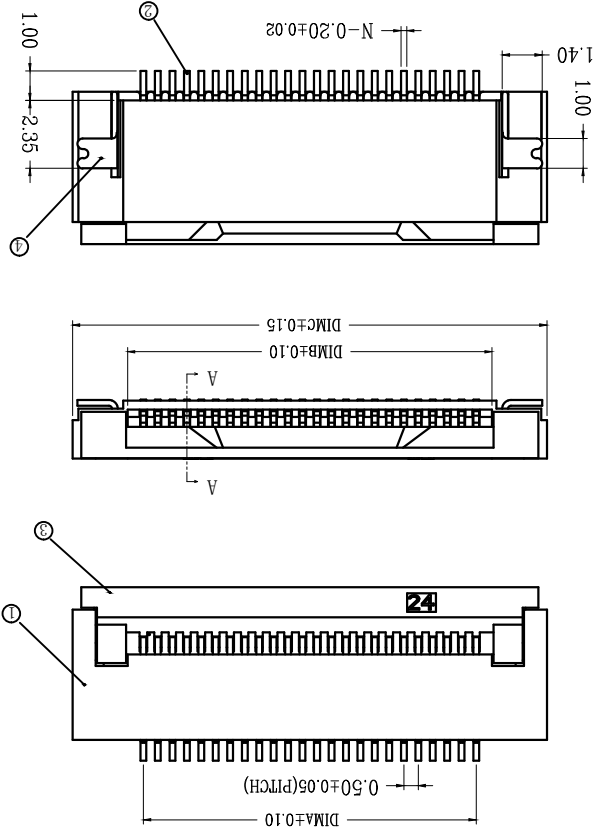

通用扁平线

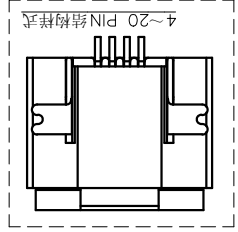
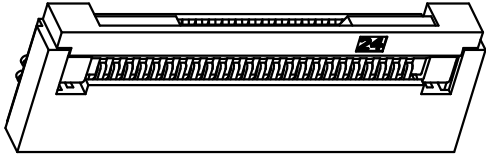
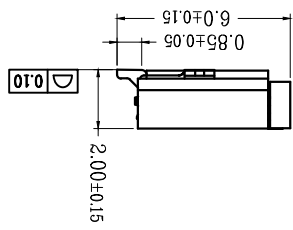
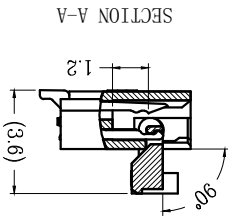
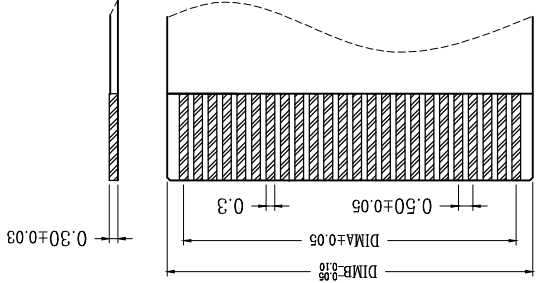

1 版次

变更摘要

2015/1/28 日期

序号

品名

材质

①	0.5 掀盖胶芯 (H2.0)	LCP UL94V-0 本色
②	0.5 掀盖端子 (H2.0)	磷青铜/表面镀锡
③	0.5 掀盖后盖 (H2.0)	LCP UL94V-0 黑色
④	0.5 掀盖焊片 (H2.0)	黄铜/表面镀锡

CKT	DIMA	DIMB	DIMC
4	1.50	2.60	6.40
5	2.00	3.10	6.90
6	2.50	3.60	7.40
7	3.00	4.10	7.90
8	3.50	4.60	8.40
9	4.00	5.10	8.90
10	4.50	5.60	9.40
11	5.00	6.10	9.90
12	5.50	6.60	10.40
13	6.00	7.10	10.90
14	6.50	7.60	11.40
15	7.00	8.10	11.90
16	7.50	8.60	12.40
17	8.00	9.10	12.90
18	8.50	9.60	13.40
19	9.00	10.10	13.90
20	9.50	10.60	14.40
21	10.00	11.10	14.90
22	10.50	11.60	15.40
23	11.00	12.10	15.90
24	11.50	12.60	16.40
25	12.00	13.10	16.90
26	12.50	13.60	17.40
27	13.00	14.10	17.90
28	13.50	14.60	18.40
29	14.00	15.10	18.90
30	14.50	15.60	19.40
31	15.00	16.10	19.90
32	15.50	16.60	20.40

CKT	DIMA	DIMB	DIMC
33	16.00	17.10	20.90
34	16.50	17.60	21.40
35	17.00	18.10	21.90
36	17.50	18.60	22.40
37	18.00	19.10	22.90
38	18.50	19.60	23.40
39	19.00	20.10	23.90
40	19.50	20.60	24.40
41	20.00	21.10	24.90
42	20.50	21.60	25.40
43	21.00	22.10	25.90
44	21.50	22.60	26.40
45	22.00	23.10	26.90
46	22.50	23.60	27.40
47	23.00	24.10	27.90
48	23.50	24.60	28.40
49	24.00	25.10	28.90
50	24.50	25.60	29.40
51	25.00	26.10	29.90
52	25.50	26.60	30.40
53	26.00	27.10	30.90
54	26.50	27.60	31.40
55	27.00	28.10	31.90
56	27.50	28.60	32.40
57	28.00	29.10	32.90
58	28.50	29.60	33.40
59	29.00	30.10	33.90
60	29.50	30.60	34.40

MINTRON TECHNOLOGY CO., LTD.

制图 (DR) TONY

校对 (CHKD) SUNNY

品名 (TITLE) 0.5 Pitch 掀盖卧式下接(H=2.0)

料号 (DWG.NO) XW05200-***

审核 (APP) JTM

张数 (SHEET) 1 OF 1
 尺寸 (SIZE) A4
 图例 (REV) A

比例 (SCALE) 1:1
 单位 (UNITS) mm

一般公差 (TOLERANCE)
 X ± 0.10
 XX ± 0.05
 XXX ± 0.02
 ANGLES ± 1°

F

E

D

C

B

A

4

3

2

1

5

4

3

2

1

X-ON Electronics

Largest Supplier of Electrical and Electronic Components

Click to view similar products for [FFC & FPC Connectors](#) category:

Click to view products by [MINTRON](#) manufacturer:

Other Similar products are found below :

[HFW11R-1STE1H1LF](#) [FH29B-100S-0.2SHW\(99\)](#) [FA5S008HP1](#) [FH29B-120S-0.2SHW\(99\)](#) [FH29B-80S-0.2SHW\(99\)](#) [FHS-16](#) [FPH-2022G](#)
[52610-1075](#) [52610-1275](#) [52610-1934](#) [XF3M\(1\)-1415-1B-R100](#) [501864-3091-TR225](#) [0525594033](#) [086210010340800](#) [086222026001800](#)
[52271-2869-CUT-TAPE](#) [62674-201121DLF](#) [62684-36210E9ALF](#) [52610-1675](#) [52746-1671-TR250](#) [10051922-2810EHLF](#) [6-520415-9](#)
[BD021-09A-A1-0350-0200-0550-LD](#) [SFV6R-1STE9HLF](#) [XF3M-2915-1B-R100](#) [1658549-1](#) [62674-221121ALF](#) [46214008010800](#)
[046298003000883](#) [151660622](#) [842-816-2630-035](#) [AYF530665TA](#) [AYF351525](#) [046296011930846+](#) [AYF352325A](#) [046254020000800+](#)
[FH19C-13S-0.5SH\(99\)](#) [FH39J-51S-0.3SHW\(99\)](#) [AYF355125A](#) [AYF530365TA](#) [FH29B-44S-0.2SHW\(99\)](#) [SFW5R-2STAE9LF](#) [AYF351125A](#)
[AYF350725A](#) [62684-502100AHLF](#) [FH39-61S-0.3SHW\(99\)](#) [AYF414035A](#) [10064555-172520HLF](#) [AYF212335A](#) [504754-2500](#)