

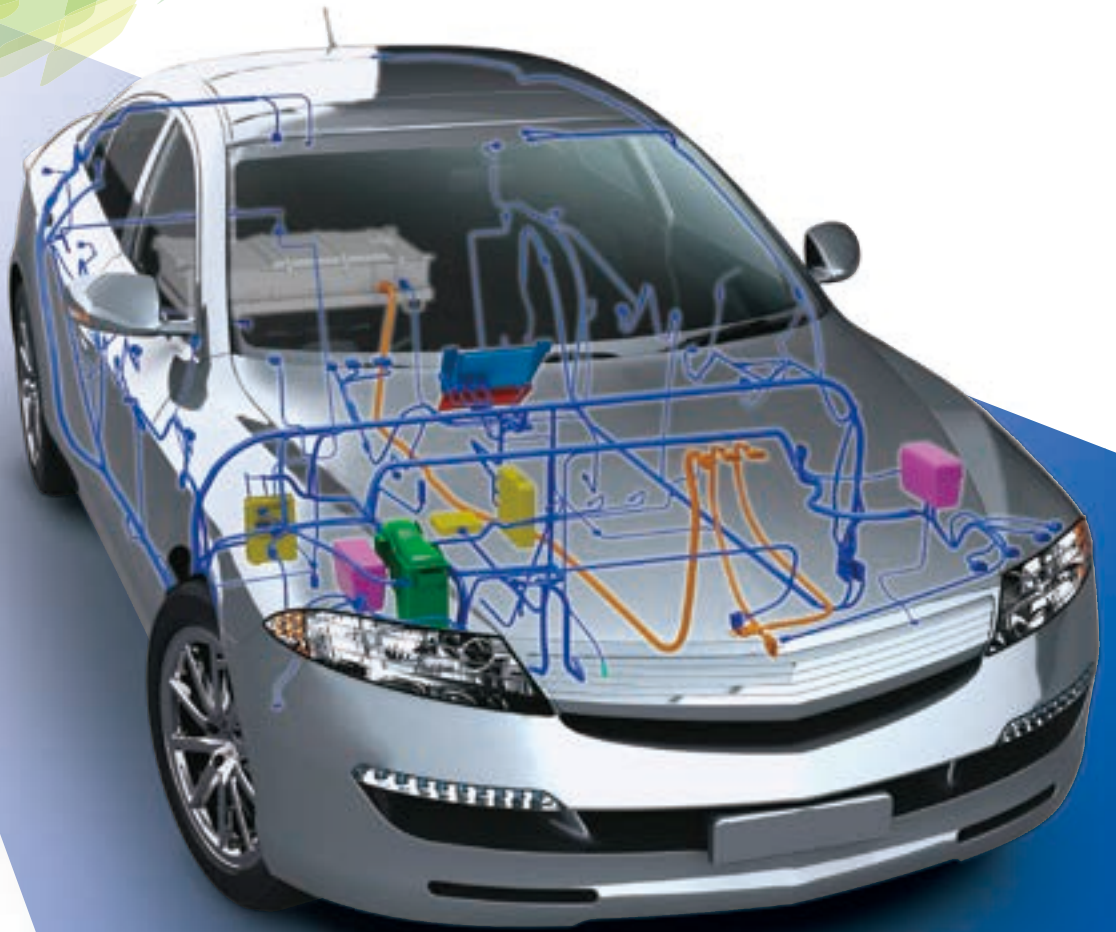

Connect with the Best

CONNECTORS FOR AUTOMOBILES

汽车用接插件



CONTENTS

unsealed / sealed 非防水 / 防水	Connector Series 接插件系列	Terminal Tab Size 端子大小	No. of Way Variation 极数种类	Applicable Cable Size 适用电线大小	Page 刊登页	Contact Resistance 接触电阻 (包括压接部)	
unsealed	TS	0.64 (025)	2, 5, 10, 14, 16, 19, 22, 24, 28, 32, 36, 40	0.13 - 0.5	A-02	8mΩ max.(initial) 16mΩ max.(after durability tests)	
		1.5 (060)	2, 4, 8, 12	0.13 - 2.0	A-07	3mΩ max.(initial) 10mΩ max.(after durability tests)	
		2.3 (090)	2, 6, 8, 9, 10, 11, 12, 13, 16, 20	0.22 - 2.0	A-10		
		4.8 (187)	1, 2, 3, 4, 6, 8, 10	0.3 - 3.0	A-14		
		8.0 (312)	1, 2, 3, 4	0.5 - 8.0	A-18		
		Hybrid	0.64+1.5	12, 18, 20	—	A-20	8mΩ max.(initial) 16mΩ max.(after durability tests)
			0.64+2.3	17, 18, 20	—	A-21	
			0.64+4.8	20	—	A-22	
			2.3+4.8	14, 15, 20	—	A-22	
		PCB	0.64	16, 33, 36, 56, 60, 68	—	A-24	8mΩ max.(initial) 16mΩ max.(after durability tests)
			0.64+1.5	20	—	A-26	8mΩ max.(initial) 16mΩ max.(after durability tests)
		HE	0.64 (025)	2, 3, 4, 6, 7, 10, 12, 16, 20, 24, 34	0.22 - 0.75	C-02	5mΩ max.(initial) 10mΩ max.(after durability tests)
	1.0 (040)		2, 5, 6, 8, 13, 17, 21	0.22 - 0.85	C-06	3mΩ max.(initial) 6mΩ max.(after durability tests)	
	2.3 (090)		2, 3, 4, 5, 6, 8, 10, 14, 16, 20	0.3 - 2.0	C-09		
	4.8 (187)		2, 4, 5	0.3 - 3.0	C-12	2mΩ max.(initial) 4mΩ max.(after durability tests)	
	9.5 (375)		1, 2	2.0 - 10.0	C-14		
	Hybrid		0.64+2.3	12, 13, 18, 20, 23, 28	—	C-16	5mΩ max.(initial) 10mΩ max.(after durability tests)
			1.0+2.3	9, 10, 14, 23	—	C-18	
			1.0+4.8	12, 14	—	C-19	
			2.3+4.8	8, 14, 16, 18, 20	—	C-20	
			4.8+8.0	6	—	C-21	
	PCB		1.0	13	—	C-22	5mΩ max.(initial) 10mΩ max.(after durability tests)
			1.0+2.3	23	—	C-22	
			1.0+4.8	14	—	C-23	
			2.3	6	—	C-23	
	NH		0.64 (025)	3, 4, 8, 10, 12, 16, 24, 32, 40	0.22 - 0.75	F-02	10mΩ max.(initial) 30mΩ max.(after durability tests)
		Hybrid	0.64+2.3	20	—	F-07	
	SL	1.5 (060)	4, 12, 14, 16	0.3 - 2.0	I-02	3mΩ max.(initial) 10mΩ max.(after durability tests)	
		2.3 (090)	2, 4, 6, 12, 14, 16, 18	0.3 - 2.0	I-05		
		2.8 (110)	4	0.3 - 3.0	I-08		
		Hybrid	1.5+2.8	14	—		I-10
	DL	0.64 (025)	2	0.22 - 0.75	K-02	5mΩ max.(initial) 10mΩ max.(after durability tests)	
1.0 (040)		4, 8, 12, 16, 20	0.3 - 1.25	K-04	3mΩ max.(initial) 10mΩ max.(after durability tests)		
2.3 (090)		2, 4, 6, 10, 14, 16	0.3 - 2.0	K-07	10mΩ max.(after durability tests)		

unsealed / sealed 非防水 / 防水	Connector Series 接插件系列	Terminal Tab Size 端子大小	No. of Way Variation 极数种类	Applicable Cable Size 适用电线大小	Page 刊登页	Contact Resistance 接触电阻 (包括压接部)			
sealed	TS sealed	0.64 (025)	2, 3, 4, 5, 6, 8, 10, 12, 13, 15, 17, 20, 30	0.13 - 0.5	B-02	8mΩ max.(initial) 16mΩ max.(after durability tests)			
		0.64W (025W)	4	0.3 - 0.6	B-08				
		Hybrid 0.64W+2.3+4.8	38, 46	—	B-10				
		2.3 (090)	2, 3, 4, 5, 6, 7	0.3 - 2.0	B-12		3mΩ max.(initial) 10mΩ max.(after durability tests)		
		4.8 (187)	1, 2, 3	0.3 - 3.0	B-19				
		8.0 (312)	1, 2	0.5 - 8.0	B-23				
		Hybrid	0.64+2.3	10, 13, 26	—		B-26	8mΩ max.(initial) 16mΩ max.(after durability tests)	
			0.64+4.8	4, 24, 34, 40, 46	—		B-27		
			0.64+2.3+4.8	42, 52	—		B-28		
			2.3+4.8	4, 5, 6, 11	—		B-29		3mΩ max.(initial) 10mΩ max.(after durability tests)
			4.8+8.0	3	—		B-30		
	HV/HVG sealed	1.0 (040)	2, 3, 4, 5, 6, 10	0.3 - 1.25	D-02	5mΩ max.(initial) 10mΩ max.(after durability tests)			
	HX sealed	1.0 (040)	1, 2, 3, 5, 6, 7	0.3 - 1.25	E-02	5mΩ max.(initial) 10mΩ max.(after durability tests)			
		1.0 (040)	23, 33		E-06				
		Joint Connector	23		E-08				
		Hybrid Joint Connector	0.64+1.0	22	—	E-10			
		1.5 (060)	2, 3, 4, 8, 12	0.13 - 2.0	E-13	3mΩ max.(initial) 6mΩ max.(after durability tests)			
		2.3 (090)	1, 2, 3, 4	0.3 - 2.0	E-17				
		Hybrid	1.0+4.8	13	—	E-21	5mΩ max.(initial) 10mΩ max.(after durability tests)		
			1.5+4.8	4, 5	—	E-21	3mΩ max.(initial) 6mΩ max.(after durability tests)		
			2.3+4.8	10	—	E-22			
	RS	2.3 (090)	1, 2, 3, 4, 5, 6, 8	0.3 - 2.0	G-02	3mΩ max.(initial) 10mΩ max.(after durability tests)			
	TL	2.3 (090)	1, 2, 4, 5	0.3 - 2.0	H-02	5mΩ max.(initial) 10mΩ max.(after durability tests)			
	SL sealed	1.5 (060)	2, 3, 14	0.3 - 2.0	J-02	3mΩ max.(initial) 10mΩ max.(after durability tests)			
		2.3 (090)	1, 2, 3, 4, 6	0.3 - 2.0	J-06				
		8.0 (312)	2	2.0 - 8.0	J-09				
	DL sealed	2.3 (090)	1, 2, 3, 4, 6, 8, 10, 12, 16	0.3 - 2.0	L-02	3mΩ max.(initial) 10mΩ max.(after durability tests)			

Safety, amenity, and functionality, measure the essential performance of an automobile and these predominately depend on in-vehicle electronic controls.

A variety of car electronic devices are systematically connected with each other using "automotive connectors", and the connectors for this purpose are required to be smaller, lighter, and provide direct connection and advanced performance.

At Sumitomo Wiring Systems, we are actively researching and developing components, including terminals and housings, with respect to the "total wiring system," using our experience as an all-round automotive wiring harness manufacturer. This is how we are able to achieve high reliability for our products.

In addition, we are searching for the optimum wiring system and layout, using as little space for wiring as is effectively possible. These are part of our activities to provide services that will further satisfy our customers, and we sincerely ask to be favored with your request for connectors made by Sumitomo Wiring Systems.

对汽车的安全性、舒适性以及功能性等要求，大多取决于电子控制。

这些具有系统性连接各种汽车电子模块功能的「汽车用接插件」，通常要求具有轻量化、小型化、直结化、高功能化等性能。

住友电装以汽车线束综合生产厂商的丰富经验以及“综合汽车线束系统”的视点，积极研究与开发端子、接插件等汽车构成部品，为提高产品的高信赖性而进行着不断的努力。

并且利用有限的配线空间内，不断地追求高效率的汽车线束系统，及其最佳配线布局。为客户提供更满意的服务，敬请订购使用住友电装的汽车用接插件。

General Notes 关于汽车用接插件目录的查阅方法

- All length and area units in this catalog shall marked millimeter (mm) and square millimeter (mm²).
- This catalog focuses on series of terminals, housings, and does not include terminals and housings not involved in these series. Similarly, some other series and custom-made parts are not included. Please contact our sales staff for details.
- We have also prepared a separate "Automotive Wire, Convuluted Tube" catalog, made by Sumitomo Wiring Systems, and suitable for the connectors. This catalog can be obtained from our sales staff.
- 该目录中的长度单位全部为 mm(毫米)、面积的单位全部为 mm²(平方毫米)。
- 该目录主要是以成为系列的端子、接插件编写。未包括在系列中的端子、接插件护套及部分系列、定制开发产品未予记载，详细内容请向敝公司销售负责人问讯。
- 另外，还备有最适合接插件的住友电装的「汽车用电线、波纹管」目录，需要时请向敝公司销售负责人索取。

Digital catalog 电子目录

A digital connector catalog is available on the Sumitomo Wiring Systems home page.

Digital catalogue has connectors which are not on this catalogue.

住友电装主页中刊登有「接插件电子目录」。

在电子目录中还刊登有该目录中未予记载的接插件。

URL: <http://www.sws.co.jp>

* Product specifications may be subject to change without notice.

Before using the product, please obtain a "customer drawing" "Specifications" "Instruction Manuals" from our sales staff.

※产品式样变更时可能不另行告知。

使用产品时，请向敝公司销售负责人索取「客户用图纸」「仕様书」「使用说明书」。

TS SERIES

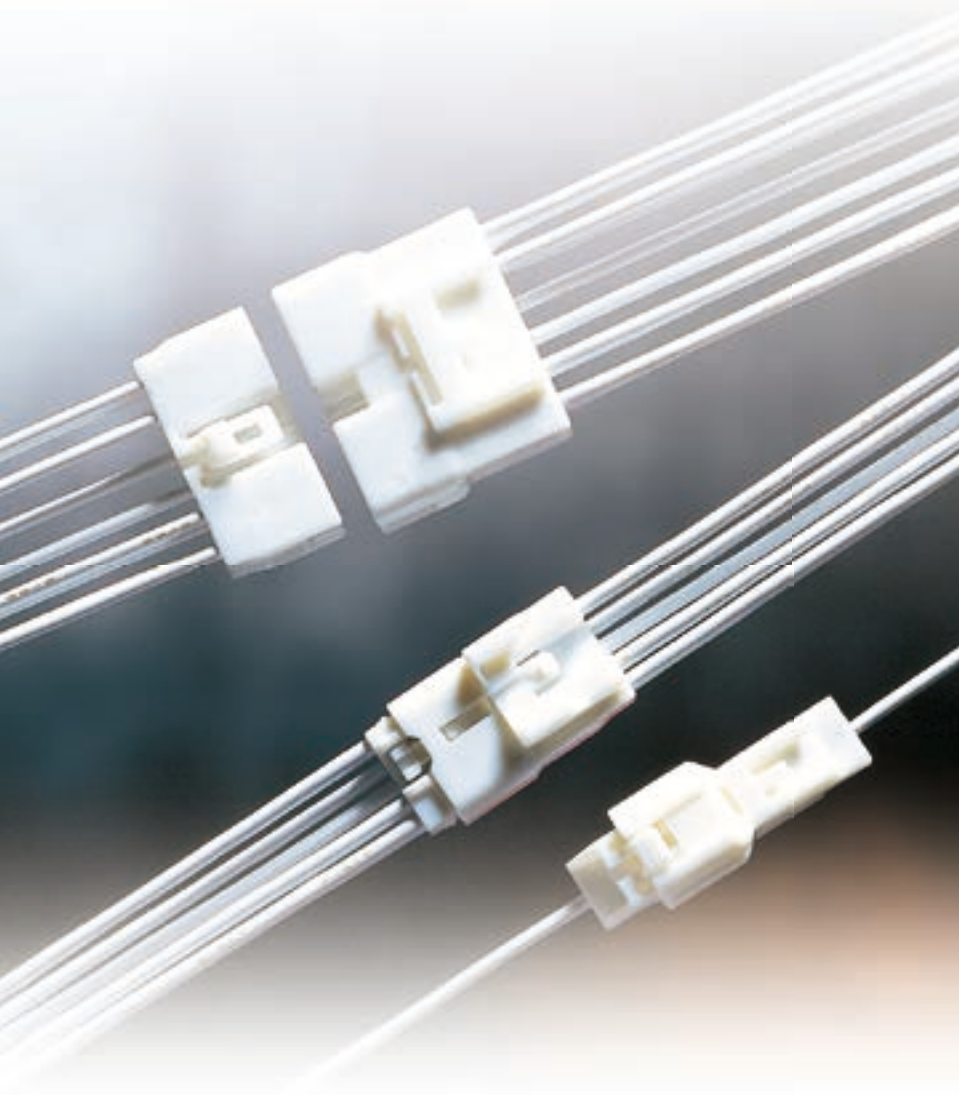

Features

The TS connector series has a mechanism of terminal position assurance.

This series consists of 0.64mm, 1.5mm, 2.3mm, 4.8mm and 8.0mm types classified according to terminal size, covering an extensive array of applications from signal to power circuits.

- The connector mechanism only allows the retainer to be set when the terminal is completely inserted.
- Retainers are pre-mounted on connector housings, and are structured to enable setting by the same simple operation regardless of the number of ways, improving operability.
- These connectors can be directly secured to a support on the car body.
- PCB models are also available for connection to printed circuit boards.
- RoHS/ELV Compliant

特点

TS 系列接插件具有检测端子插入不足的功能。按照端子尺寸划分为0.64mm·1.5mm·2.3mm·4.8mm·8.0mm，从信号回路到电源回路，能广泛应用。

- 它具有当端子在半插入状态时，锁片无法安装的结构。
- 锁片预先组装在接插件护套上，无论多少极数都能通过简单操作进行组合，有助于提高效率。
- 接插件可以直接固定在车体的支架上。
- 我们还设定了能适用于印制线路板的 PCB 接插件。
- 可对应欧盟 RoHS 和 ELV 指令

TS SERIES for STANDARD

0.64mm (025)

A-02

Structure / 构造

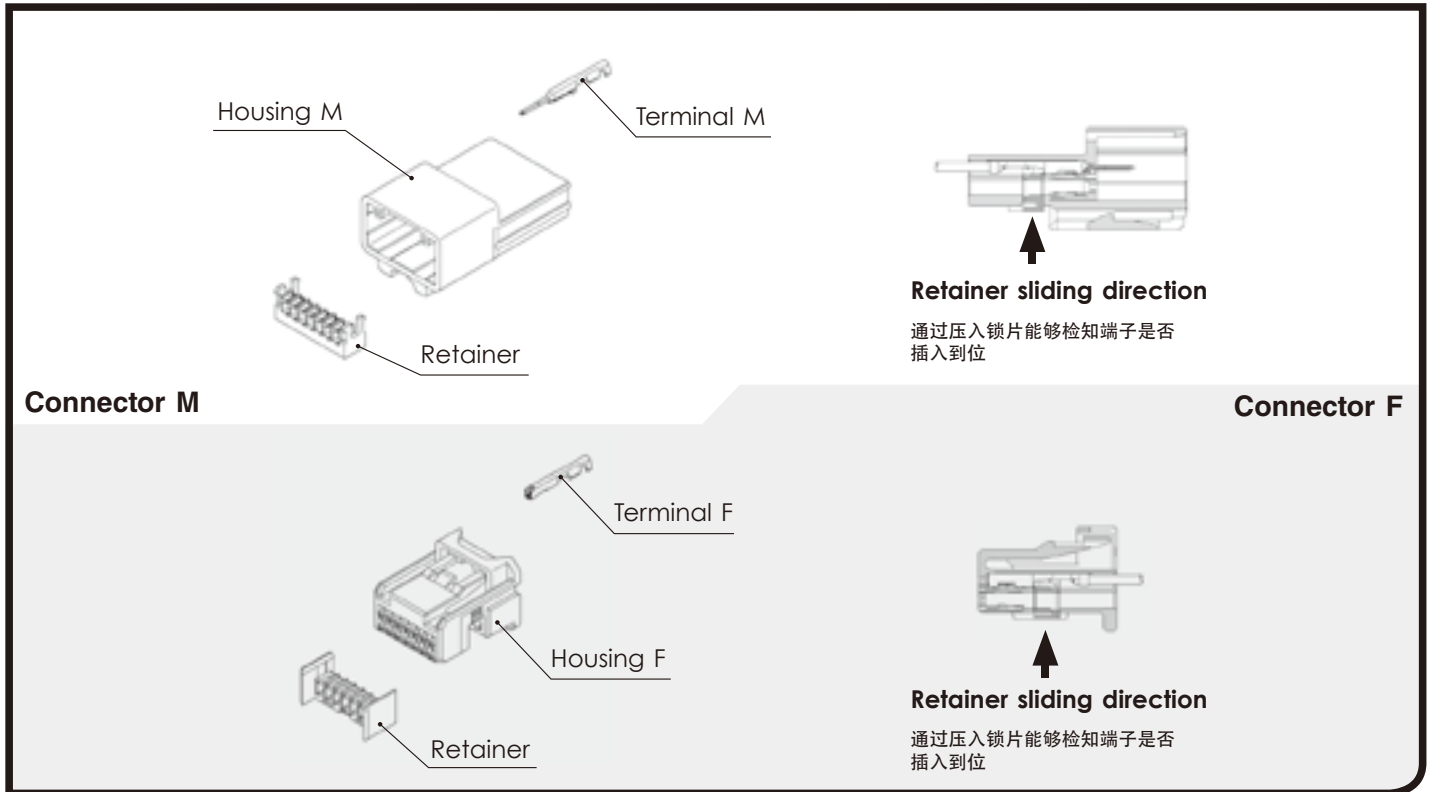

0.64mm (025)

Terminal (UNIT : mm)

端子(毫米)

(S)

Cable size (mm²) 适用电线大小	0.13
Material 材质	Brass 黄铜
Surface treatment 表面处理	Tin-plated 镀锡

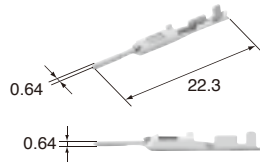
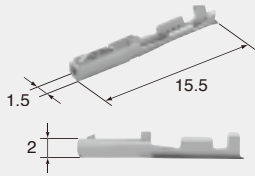
**M (8230-4878)****F (8240-0182)**

Cable size (mm²) 适用电线大小	0.13
Material 材质	Heat-resistant copper alloy
Surface treatment 表面处理	Tin-plated 镀锡

(S)**Au**

Cable size (mm²) 适用电线大小	0.13
Material 材质	Brass 黄铜
Surface treatment 表面处理	Gold-plated 镀金

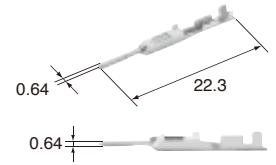
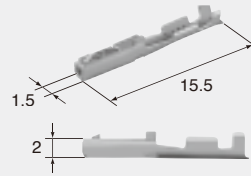
**M (8230-5136)****F (8240-0338)**

Cable size (mm²) 适用电线大小	0.13
Material 材质	Heat-resistant copper alloy
Surface treatment 表面处理	Gold-plated 镀金

(M)

Cable size (mm²) 适用电线大小	0.22~0.35
Material 材质	Brass 黄铜
Surface treatment 表面处理	Tin-plated 镀锡

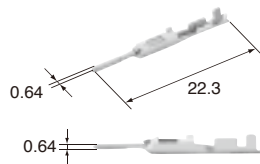
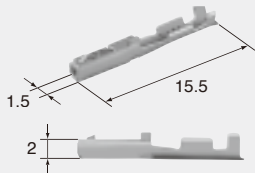
**M (8100-3622)****F (8100-3624)**

Cable size (mm²) 适用电线大小	0.22~0.35
Material 材质	Heat-resistant copper alloy
Surface treatment 表面处理	Tin-plated 镀锡

(M)**Au**

Cable size (mm²) 适用电线大小	0.22~0.35
Material 材质	Brass 黄铜
Surface treatment 表面处理	Gold-plated 镀金

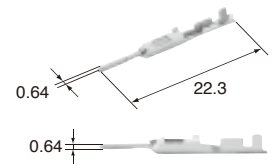
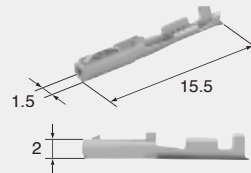
**M (8100-3626)****F (8100-3628)**

Cable size (mm²) 适用电线大小	0.22~0.35
Material 材质	Heat-resistant copper alloy
Surface treatment 表面处理	Gold-plated 镀金

(L)

Cable size (mm²) 适用电线大小	0.3~0.5
Material 材质	Brass 黄铜
Surface treatment 表面处理	Tin-plated 镀锡

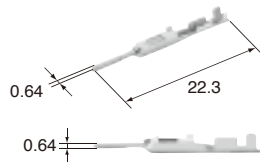
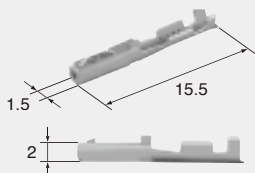
**M (8100-3623)****F (8100-3625)**

Cable size (mm²) 适用电线大小	0.3~0.5
Material 材质	Heat-resistant copper alloy
Surface treatment 表面处理	Tin-plated 镀锡

(L)**Au**

Cable size (mm²) 适用电线大小	0.3~0.5
Material 材质	Brass 黄铜
Surface treatment 表面处理	Gold-plated 镀金

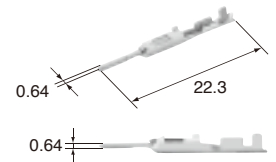
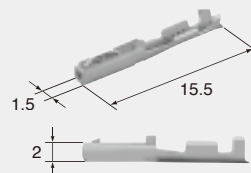
**M (8100-3627)****F (8100-3629)**

Cable size (mm²) 适用电线大小	0.3~0.5
Material 材质	Heat-resistant copper alloy
Surface treatment 表面处理	Gold-plated 镀金

0.64mm (025)

A-04

Housing (UNIT : mm)

接插件护套(毫米)

Ref: Terminal part No. A-02
端子参照页

Material PBT
材质

2way

Color Natural
颜色 自然色

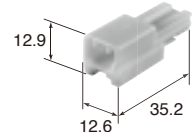

M (6098-6653)

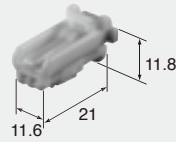

F (6098-6662)

Color Natural
颜色 自然色

5way

Color Natural
颜色 自然色

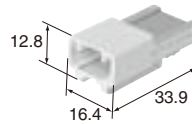

M (6098-3802)

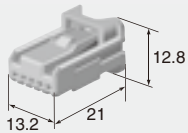

F (6098-3810)

Color Natural
颜色 自然色

10way

Color Natural
颜色 自然色

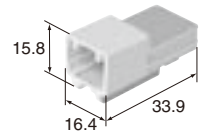

M (6098-3869)

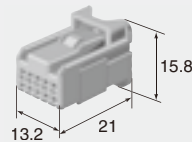

F (6098-3909)

Color Natural
颜色 自然色

14way

Color Natural
颜色 自然色

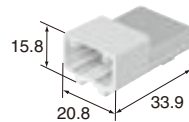

M (6098-3877)

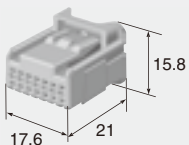

F (6098-3917)

Color Natural
颜色 自然色

14way

F (6098-7241)

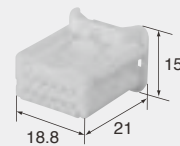

Color Natural
颜色 自然色

16way

Color 颜色 Natural 自然色

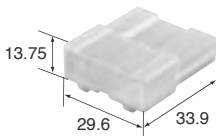

M (6098-7336) **F (6098-4008)**

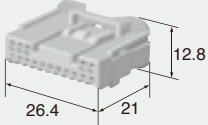

Color 颜色 Natural 自然色

16way **F (6098-6688)**

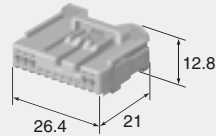

Color 颜色 Natural 自然色

16way **F (6098-6694)**

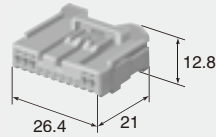

Color 颜色 Natural 自然色

19way **F (6098-7231)**

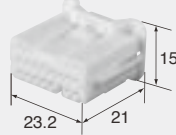

Color 颜色 Natural 自然色

22way

Color 颜色 Natural 自然色

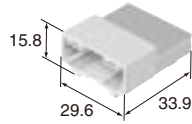

M (6098-3885) **F (6098-3925)**

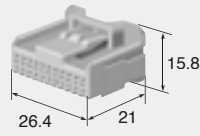

Color 颜色 Natural 自然色

24way **F (6098-4010)**

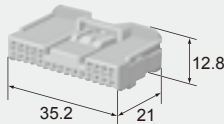

Color 颜色 Natural 自然色

24way **F (6098-6682)**

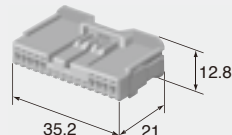

Color 颜色 Natural 自然色

28way **F (6098-4756)**

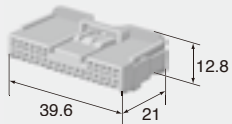

Color 颜色 Natural 自然色

32way **F (6098-4013)**

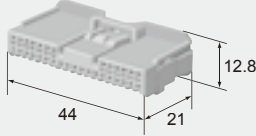

Color 颜色 Natural 自然色

36way

F (6098-4740)

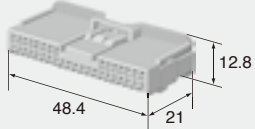

Color: Natural
颜色: 自然色

40way

F (6098-4015)

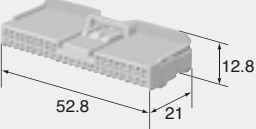

Color: Natural
颜色: 自然色

40way

F (6098-4831)

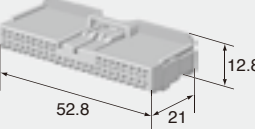

Color: Natural
颜色: 自然色

TS SERIES for STANDARD

1.5mm (060)

Structure / 构造

A-07

TS SERIES

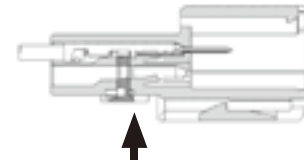
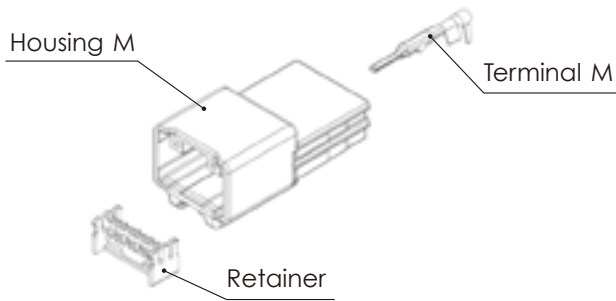

Retainer sliding direction

通过压入锁片能够检知端子是否插入到位

Connector M

Connector F

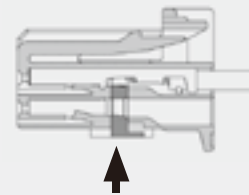
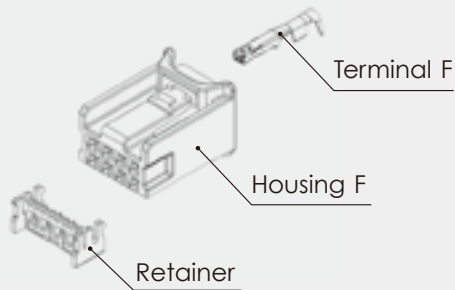

Retainer sliding direction

通过压入锁片能够检知端子是否插入到位

1.5mm (060)

A-08

Terminal (UNIT : mm)

端子 (毫米)

(3S)

F (8240-0339)

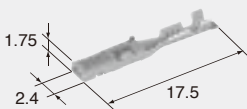

Cable size (mm²) 适用电线大小	0.13
Material 材 质	Heat-resistant copper alloy
Surface treatment 表面处理	Tin-plated 镀锡

(SS)

F (8240-0279)

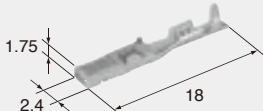

Cable size (mm²) 适用电线大小	0.22~0.35
Material 材 质	Heat-resistant copper alloy
Surface treatment 表面处理	Tin-plated 镀锡

(M)

Cable size (mm²) 适用电线大小	0.75~1.25
Material 材 质	Brass 黄铜
Surface treatment 表面处理	Tin-plated 镀锡

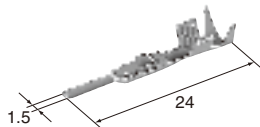

M (8230-4924)

F (8240-0213)

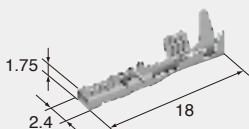

Cable size (mm²) 适用电线大小	0.75~1.25
Material 材 质	Heat-resistant copper alloy
Surface treatment 表面处理	Tin-plated 镀锡

(S)

Cable size (mm²) 适用电线大小	0.3~0.5
--	---------

Material 材 质	Brass 黄铜
Surface treatment 表面处理	Tin-plated 镀锡

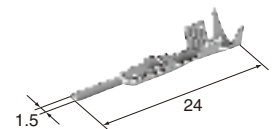

M (8230-4925)

F (8240-0215)

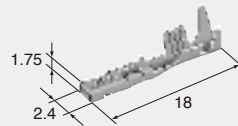

Cable size (mm²) 适用电线大小	0.3~0.5
Material 材 质	Heat-resistant copper alloy
Surface treatment 表面处理	Tin-plated 镀锡

(L)

Cable size (mm²) 适用电线大小	2.0
Material 材 质	Heat-resistant copper alloy
Surface treatment 表面处理	Tin-plated 镀锡

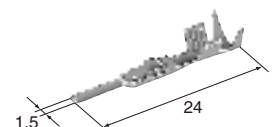

M (8230-4923)

F (8240-0214)

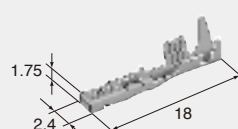

Cable size (mm²) 适用电线大小	2.0
Material 材 质	Heat-resistant copper alloy
Surface treatment 表面处理	Tin-plated 镀锡

1.5mm (060)

Housing (UNIT : mm)

接插件护套(毫米)

Ref: Terminal part No. A-08
端子参照页

Material PBT
材质

2way

Color Natural
颜色 自然色

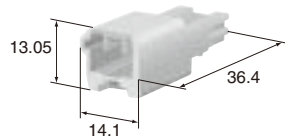

M (6098-6050)

F (6098-6053)

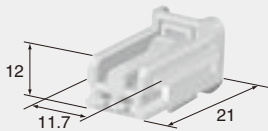

Color Natural
颜色 自然色

4way

Color Natural
颜色 自然色

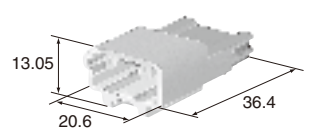

M (6098-5668)

F (6098-5677)

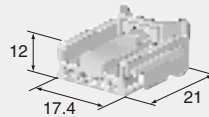

Color Natural
颜色 自然色

8way

Color Natural
颜色 自然色

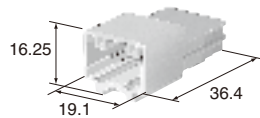

M (6098-5686)

F (6098-5695)

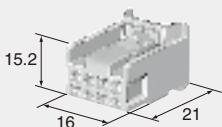

Color Natural
颜色 自然色

12way

Color Natural
颜色 自然色

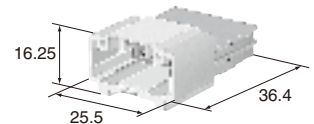

M (6098-5704)

F (6098-5713)

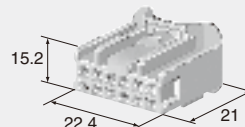

Color Natural
颜色 自然色

TS SERIES for STANDARD

2.3mm (090)

A-10

Structure / 构造

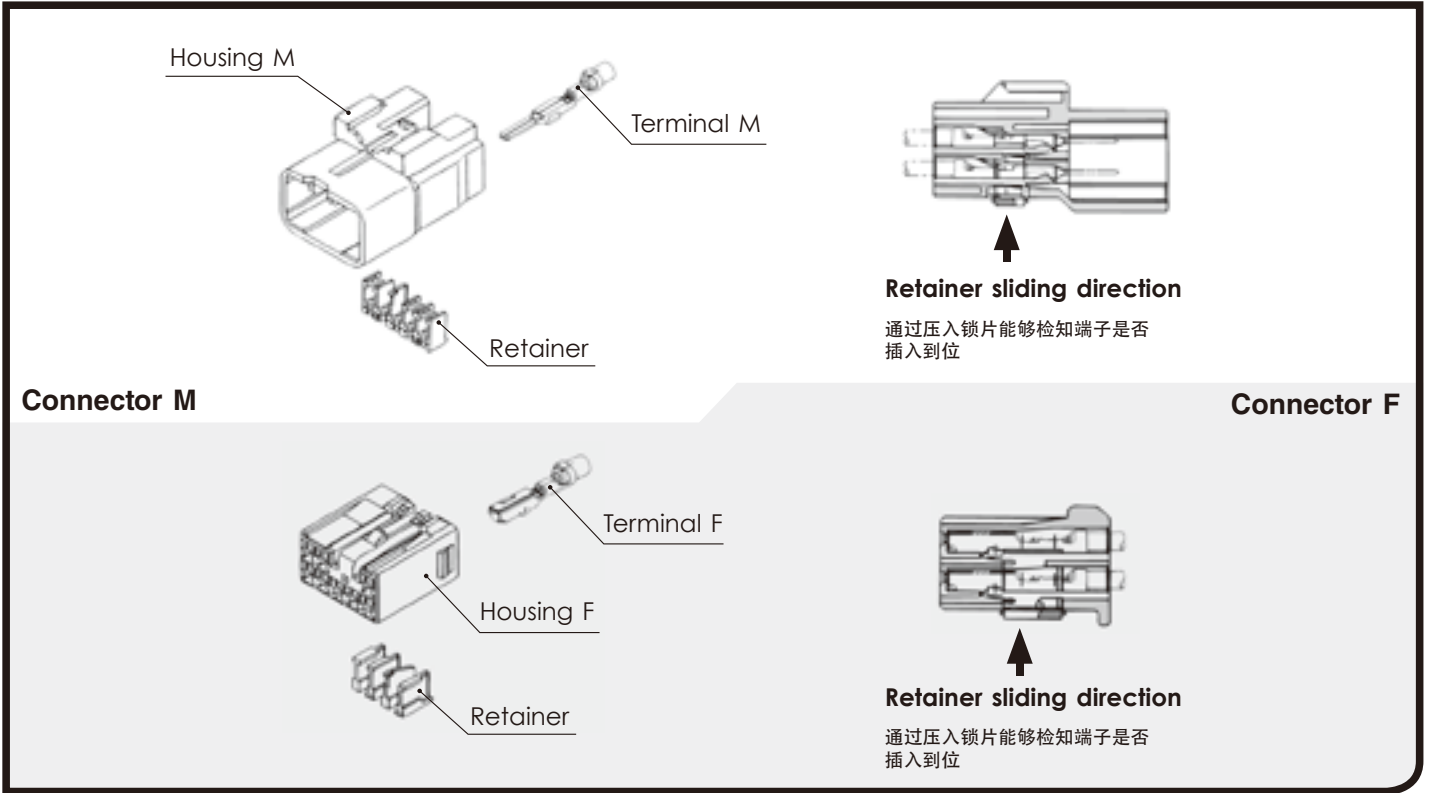

2.3mm (090)

Terminal (UNIT : mm)

端子 (毫米)

(SS)

Cable size (mm ²) 适用电线大小	0.22~0.35
Material 材质	Brass 黄铜
Surface treatment 表面处理	Tin-plated 镀锡

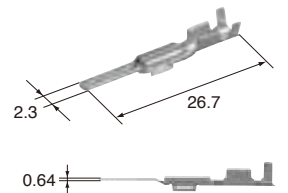

M (8230-4742)

F (8240-0029)

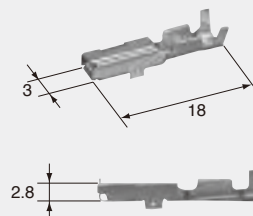

Cable size (mm ²) 适用电线大小	0.22~0.35
Material 材质	Brass 黄铜
Surface treatment 表面处理	Tin-plated 镀锡

(S)

Cable size (mm ²) 适用电线大小	0.3~0.5
---	---------

Material 材质	Brass 黄铜
----------------	-------------

Surface treatment 表面处理	Tin-plated 镀锡
---------------------------	------------------

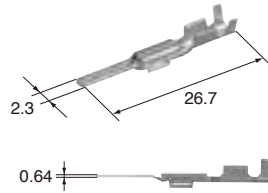
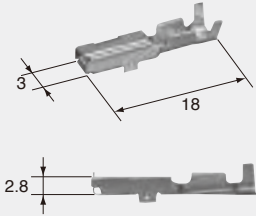
**M (8230-4492)****F (8240-4882)**

Cable size (mm ²) 适用电线大小	0.3~0.5
---	---------

Material 材质	Brass 黄铜
----------------	-------------

Surface treatment 表面处理	Tin-plated 镀锡
---------------------------	------------------

(S)**Au**

Cable size (mm ²) 适用电线大小	0.3~0.5
---	---------

Material 材质	Brass 黄铜
----------------	-------------

Surface treatment 表面处理	Gold-plated 镀金
---------------------------	-------------------

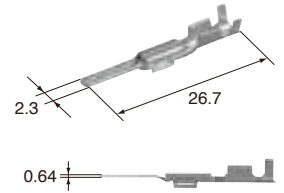
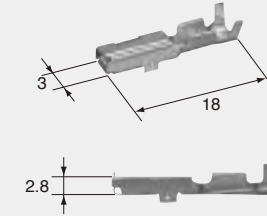
**M (8100-1341)****F (8100-1346)**

Cable size (mm ²) 适用电线大小	0.3~0.5
---	---------

Material 材质	Brass 黄铜
----------------	-------------

Surface treatment 表面处理	Gold-plated 镀金
---------------------------	-------------------

(M)

Cable size (mm ²) 适用电线大小	0.5~1.25
---	----------

Material 材质	Brass 黄铜
----------------	-------------

Surface treatment 表面处理	Tin-plated 镀锡
---------------------------	------------------

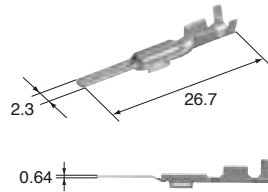
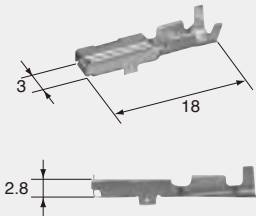
**M (8230-4502)****F (8240-4892)**

Cable size (mm ²) 适用电线大小	0.5~1.25
---	----------

Material 材质	Brass 黄铜
----------------	-------------

Surface treatment 表面处理	Tin-plated 镀锡
---------------------------	------------------

(M)**Au**

Cable size (mm ²) 适用电线大小	0.5~1.25
---	----------

Material 材质	Brass 黄铜
----------------	-------------

Surface treatment 表面处理	Gold-plated 镀金
---------------------------	-------------------

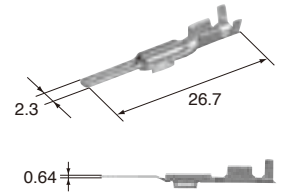
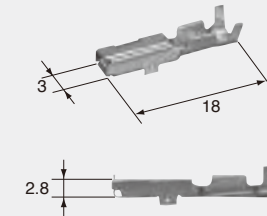
**M (8100-1342)****F (8100-1347)**

Cable size (mm ²) 适用电线大小	0.5~1.25
---	----------

Material 材质	Brass 黄铜
----------------	-------------

Surface treatment 表面处理	Gold-plated 镀金
---------------------------	-------------------

(L)

Cable size (mm ²) 适用电线大小	2.0
---	-----

Material 材质	Brass 黄铜
----------------	-------------

Surface treatment 表面处理	Tin-plated 镀锡
---------------------------	------------------

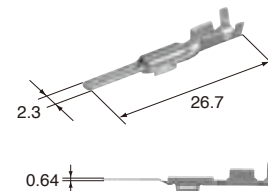
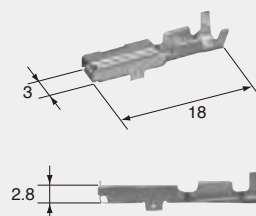
**M (8230-4512)****F (8240-4942)**

Cable size (mm ²) 适用电线大小	2.0
---	-----

Material 材质	Heat-resistant copper alloy
----------------	--------------------------------

Surface treatment 表面处理	Tin-plated 镀锡
---------------------------	------------------

2.3mm (090)

Housing (UNIT : mm)

接插件护套(毫米)

Ref: Terminal part No. A-10
端子参照页

2way

Material 材质	PA6T
Color 颜色	Natural 自然色

M (6520-0549)	F (6520-0550)
----------------------	----------------------

Material 材质	PA6T
Color 颜色	Natural 自然色

6way

Material 材质	PBT
Color 颜色	Natural 自然色
Note 备注	With clamp for 7mm dia. 带φ7用卡钉

Material 材质	PBT
Color 颜色	Natural 自然色
Note 备注	With body fastening clamp. 带防转卡钉

M (6240-1107)	M (6249-1243)	F (6240-5118)
----------------------	----------------------	----------------------

Material 材质	PBT
Color 颜色	Natural 自然色

6way

M (6240-1120)

Material 材质	PBT
Color 颜色	Natural 自然色

9way

Material 材质	PBT
Color 颜色	Natural 自然色

8way

M (6240-1077)

Material 材质	PBT
Color 颜色	Natural 自然色

M (6249-1229)	F (6248-5270)
----------------------	----------------------

Material 材质	PBT
Color 颜色	Natural 自然色

10way

Material
材质 PBT

Color
颜色 Natural
自然色

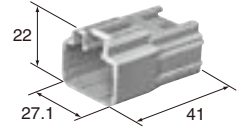

M (6249-1235)

F (6248-5276)

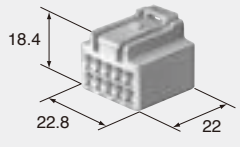

Material
材质 PBT

Color
颜色 Natural
自然色

11way

Material
材质 PBT

Color
颜色 Natural
自然色

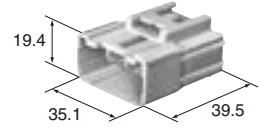

M (6249-1234)

F (6248-5275)

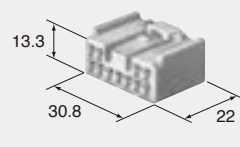

Material
材质 PBT

Color
颜色 Natural
自然色

12way

Material
材质 PBT

Color
颜色 Natural
自然色

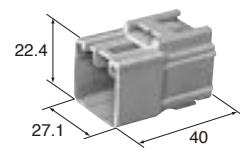

M (6520-1009)

F (6520-1004)

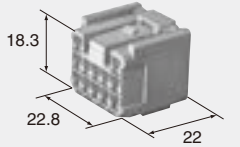

Material
材质 PBT

Color
颜色 Natural
自然色

13way

Material
材质 PBT

Color
颜色 Natural
自然色

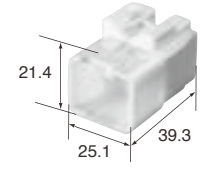

M (6240-1122)

F (6240-5175)

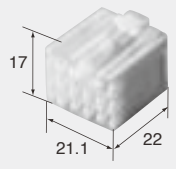

Material
材质 PBT

Color
颜色 Natural
自然色

16way

Material
材质 PBT

Color
颜色 Natural
自然色

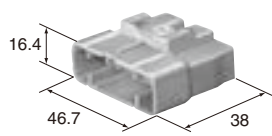

M (6240-1158)

F (6240-5088)

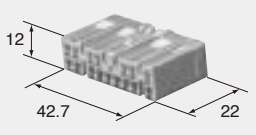

Material
材质 PBT

Color
颜色 Natural
自然色

20way

Material
材质 PBT

Color
颜色 Natural
自然色

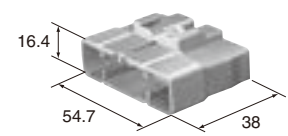

M (6240-1033)

F (6240-5035)

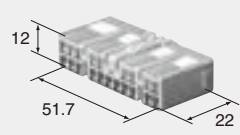

Material
材质 PBT

Color
颜色 Natural
自然色

TS SERIES for STANDARD

4.8mm (187)

A-14

Structure / 构造

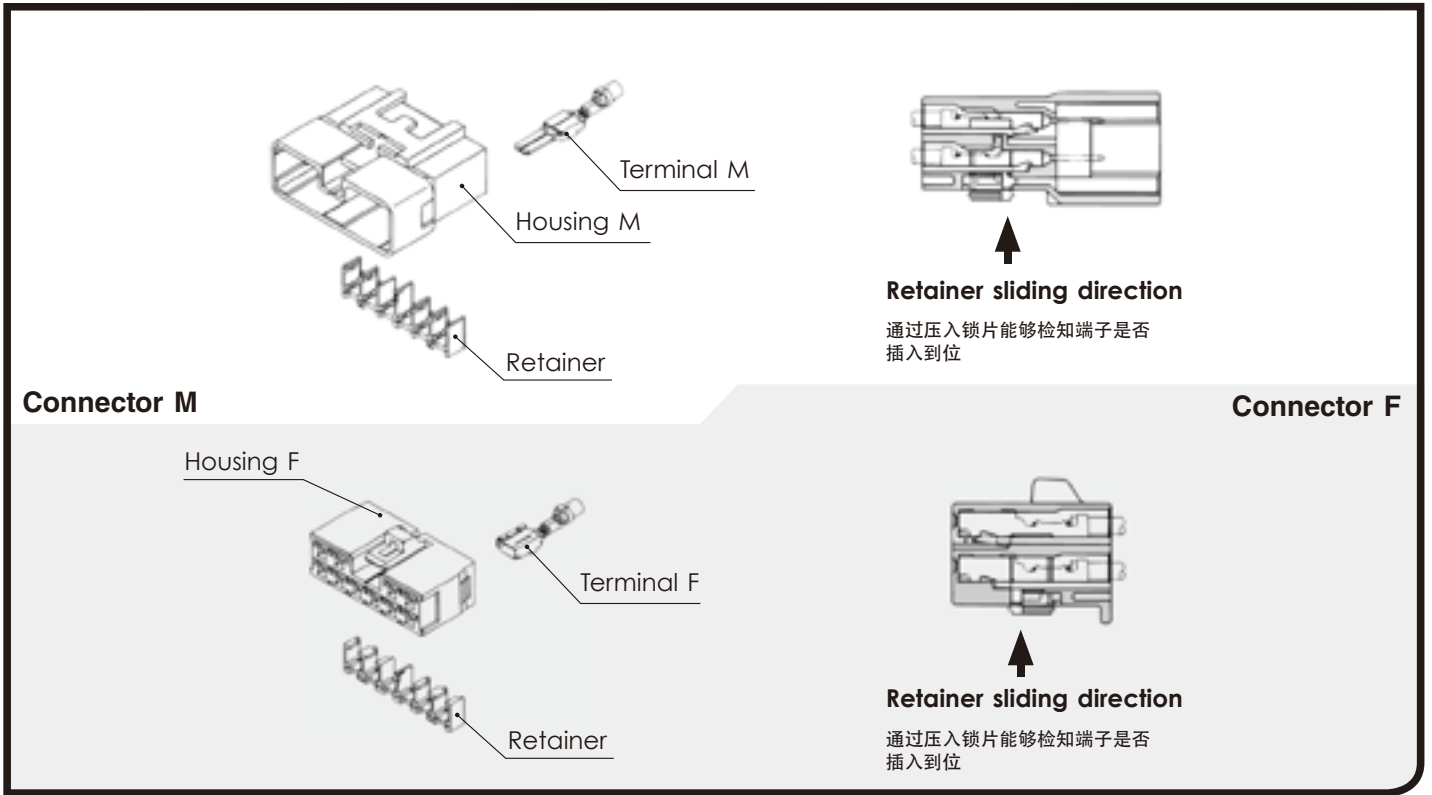

4.8mm (187)

Terminal (UNIT : mm)

端子(毫米)

(S)

Cable size (mm²) 0.3~0.5

适用电线大小

Material Brass

材质 黄铜

Surface treatment Tin-plated

表面处理 镀锡

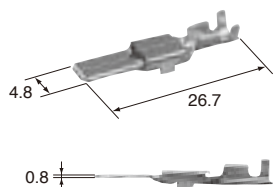

(M)

Cable size (mm²) 0.5~1.25

适用电线大小

Material Brass

材质 黄铜

Surface treatment Tin-plated

表面处理 镀锡

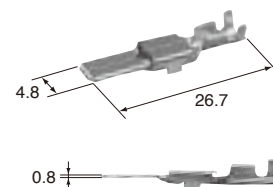

M (8230-4522)

F (8240-4912)

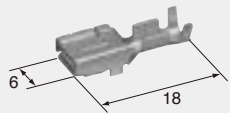
Cable size (mm²) 0.3~0.5

适用电线大小

Material Brass

材质 黄铜

Surface treatment Tin-plated

表面处理 镀锡



M (8230-4532)

F (8240-4922)

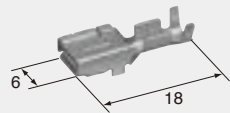
Cable size (mm²) 0.5~1.25

适用电线大小

Material Brass

材质 黄铜

Surface treatment Tin-plated

表面处理 镀锡



(L)

Cable size (mm²) 2.0~3.0

适用电线大小

Material Brass

材质 黄铜

Surface treatment Tin-plated

表面处理 镀锡

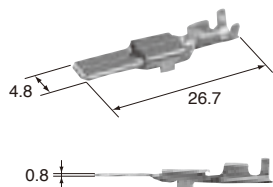

(L)

F (8100-1555)

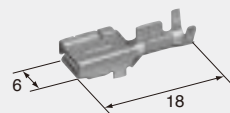
Cable size (mm²) 2.0~3.0

适用电线大小

Material Heat-resistant copper alloy

材质 耐热铜合金

Surface treatment Tin-plated

表面处理 镀锡



M (8230-4542)

F (8240-4932)

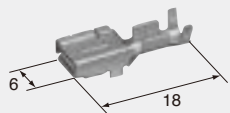
Cable size (mm²) 2.0~3.0

适用电线大小

Material Brass

材质 黄铜

Surface treatment Tin-plated

表面处理 镀锡



4.8mm (187)

Housing (UNIT : mm)

接插件护套(毫米)

Ref: Terminal part No.

端子参照页

A-14

Material

材质

PBT

1way

Color

颜色

Natural

自然色

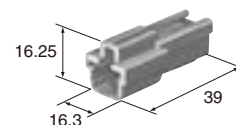

M (6098-0822)

F (6098-0824)

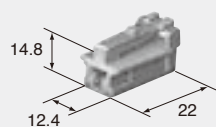

Color

颜色

Natural

自然色

2way

Color 颜色 Natural 自然色

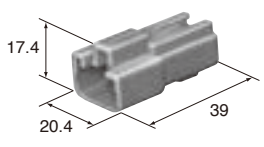

M (6098-0323)

F (6098-0325)

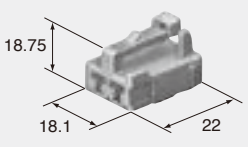

Color 颜色 Natural 自然色

2way

Color 颜色 Natural 自然色

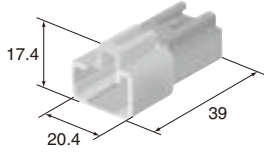

M (6098-0469)

F (6098-0471)

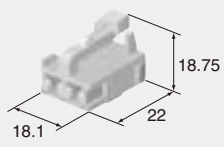

Color 颜色 Natural 自然色

3way

Color 颜色 Natural 自然色

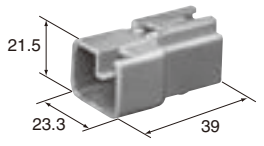

M (6098-0149)

F (6098-0151)

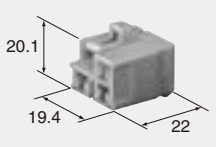

Color 颜色 Natural 自然色

4way

Color 颜色 Natural 自然色

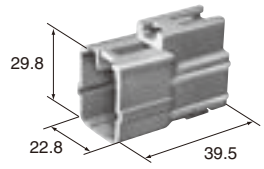

M (6098-1851)

F (6098-1489)

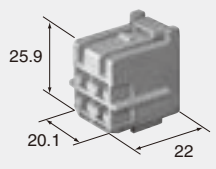

Color 颜色 Natural 自然色

6way

Color 颜色 Natural 自然色

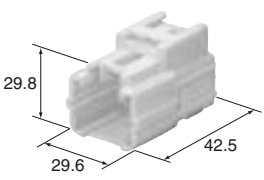

M (6098-2211)

F (6098-1716)

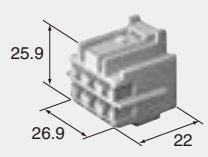

Color 颜色 Natural 自然色

8way

F (6098-0518)

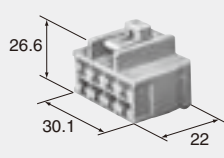

Color 颜色 Natural 自然色

10way

Color Natural
颜色 自然色

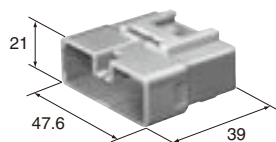

M (6098-0154)

F (6098-0156)

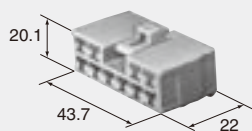

Color Natural
颜色 自然色

TS SERIES for STANDARD

8.0mm (312)

A-18

Structure / 构造

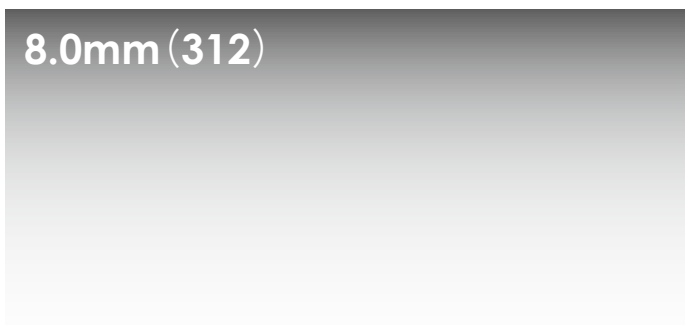
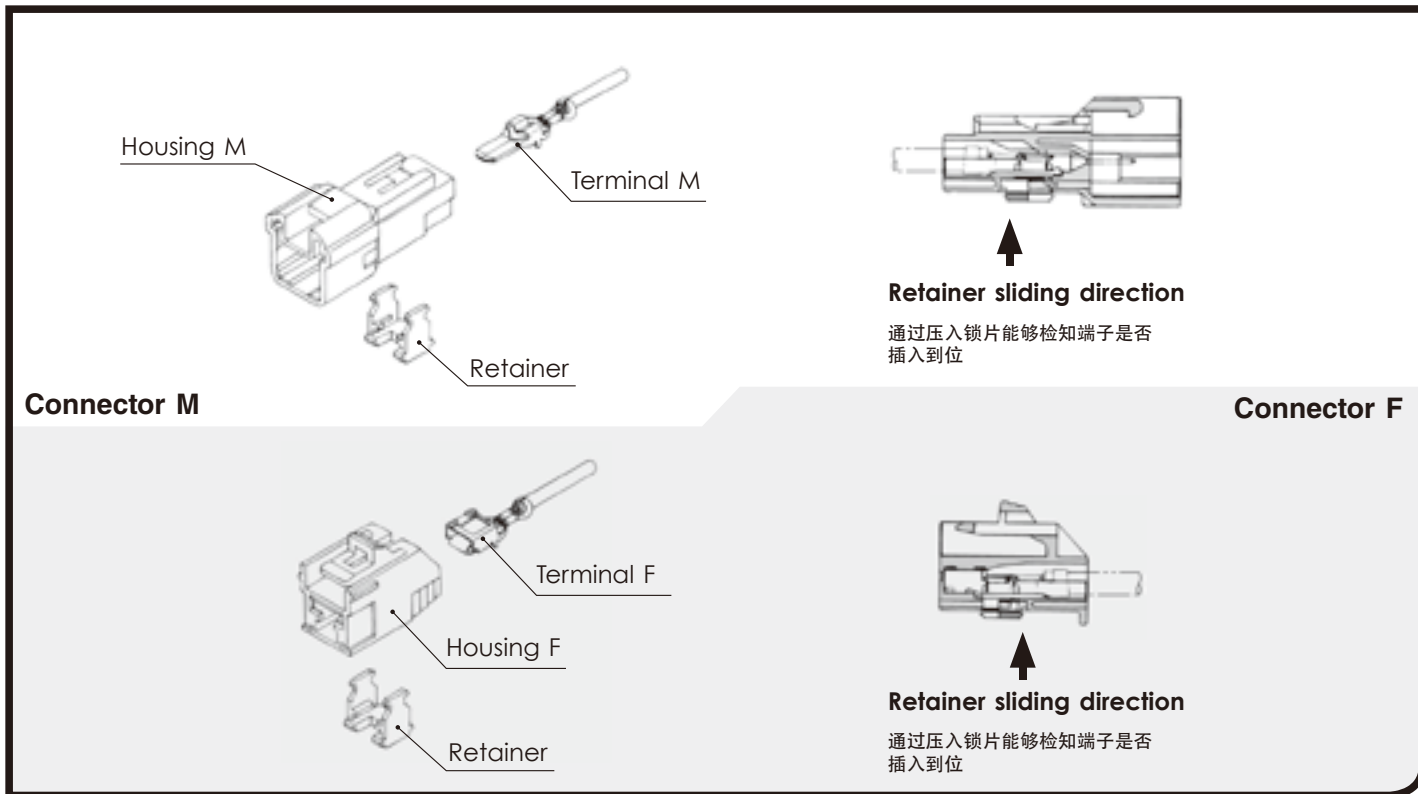

8.0mm (312)

Terminal (UNIT: mm)

端子 (毫米)

(S)

Cable size (mm ²) 适用电线大小	0.5~1.25
Material 材质	Brass 黄铜
Surface treatment 表面处理	Tin-plated 镀锡

8 32.3 0.8

M (8100-0520)

9.2 23.4 5

F (8100-0707)

Cable size (mm ²) 适用电线大小	0.5~1.25
Material 材质	Brass 黄铜
Surface treatment 表面处理	Tin-plated 镀锡

(M)

Cable size (mm ²) 适用电线大小	2.0~3.0
Material 材质	Brass 黄铜
Surface treatment 表面处理	Tin-plated 镀锡

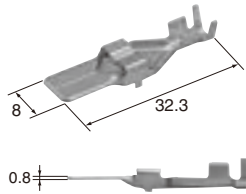
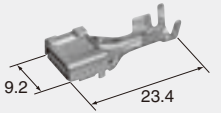
**M (8100-0521)**

Cable size (mm ²) 适用电线大小	2.0~3.0
Material 材质	Heat-resistant copper alloy
Surface treatment 表面处理	Tin-plated 镀锡

F (8100-2493)**(L)**

Cable size (mm ²) 适用电线大小	5.0~8.0
Material 材质	Brass 黄铜
Surface treatment 表面处理	Tin-plated 镀锡

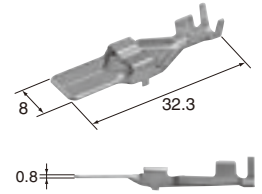
**M (8100-0522)**

Cable size (mm ²) 适用电线大小	5.0~8.0
Material 材质	Heat-resistant copper alloy
Surface treatment 表面处理	Tin-plated 镀锡

F (8100-1553)**8.0mm (312)****Housing** (UNIT : mm)

接插件护套(毫米)

Ref: Terminal part No. A-18
端子参照页

Material PBT
材质

1way

Color Natural
颜色 自然色

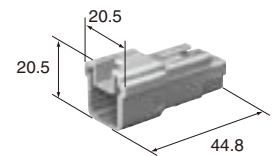
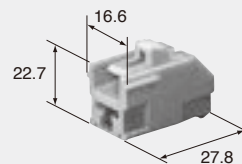
**M (6240-1093)****F (6098-0441)**

Color Natural
颜色 自然色

2way

Color Natural
颜色 自然色

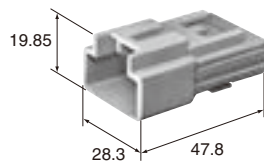
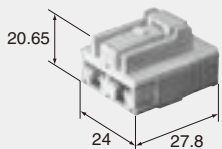
**M (6098-1278)**

Color Natural
颜色 自然色

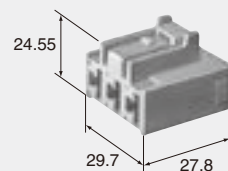
F (6098-1104)**3way****F (6520-1466)**

Color Natural
颜色 自然色

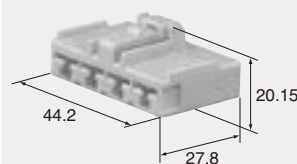
4way**F (6098-2137)**

Color Natural
颜色 自然色

0.64mm, 1.5mm
(025, 060)

Housing (UNIT : mm)

接插件护套(毫米)

Ref: Terminal part No. [0.64mm] A-02
端子参照页 [1.5mm] A-08

Material PBT
材质

No. of way/ () corresponds to 0.64mm, 1.5mm, in order from left to right.
极数 / () 内显示 : 从左向右为0.64mm 极数、1.5mm 极数

TS SERIES
for HYBRID

12way (4+8)

Color Natural
颜色 自然色

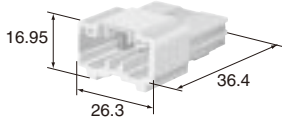

M (6098-6055)

F (6098-6083)

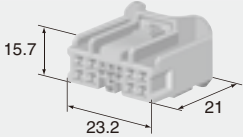

Color Natural
颜色 自然色

12way (6+6)

Color Natural
颜色 自然色

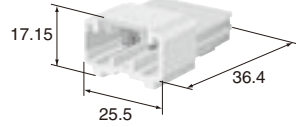

M (6098-6104)

F (6098-6111)

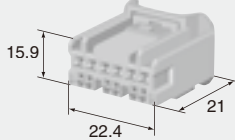

Color Natural
颜色 自然色

12way (8+4)

Color Natural
颜色 自然色

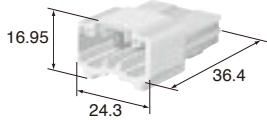

M (6098-6090)

F (6098-6097)

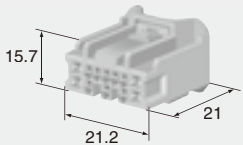

Color Natural
颜色 自然色

18way (8+10)

Color Natural
颜色 自然色

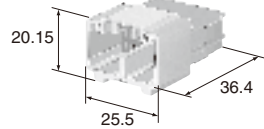

M (6098-5650)

F (6098-5659)

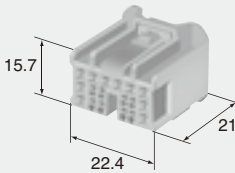

Color Natural
颜色 自然色

18way (10+8)

Color 颜色 Natural 自然色

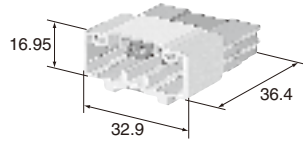

M (6098-5594)

F (6098-5604)

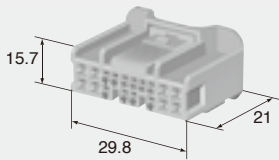

Color 颜色 Natural 自然色

18way (12+6)

Color 颜色 Natural 自然色

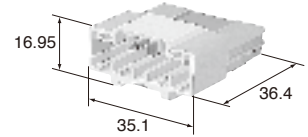

M (6098-5631)

F (6098-5641)

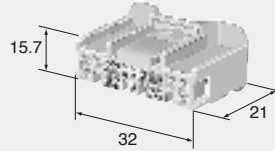

Color 颜色 Natural 自然色

20way (16+4)

Color 颜色 Natural 自然色

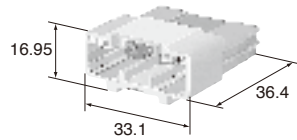

M (6098-5613)

F (6098-5622)

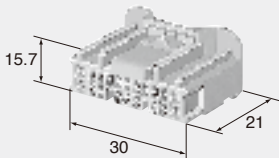

Color 颜色 Natural 自然色

**0.64mm, 2.3mm
(025, 090)**

Housing (UNIT : mm)

接插件护套(毫米)

Ref: Terminal part No. [0.64mm] A-02
端子参照页 [2.3mm] A-10

Material 材质 PBT

No. of way/ () corresponds to 0.64mm, 2.3mm, in order from left to right.
极数 / () 内显示: 从左向右为0.64mm 极数、2.3mm 极数

17way (8+9)

Color 颜色 Natural 自然色

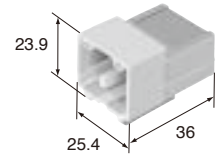

M (6098-3893)

F (6098-3933)

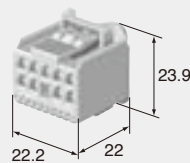

Color 颜色 Natural 自然色

18way (10+8)

Color Natural
颜色 自然色

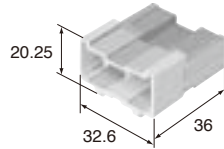

M (6098-3901)

F (6098-3941)

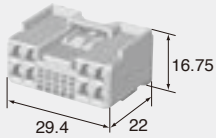

Color Natural
颜色 自然色

20way (16+4)

Color Natural
颜色 自然色

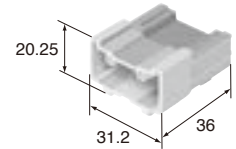

M (6098-3818)

F (6098-3826)

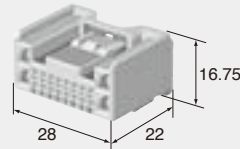

Color Natural
颜色 自然色

0.64mm, 4.8mm (025, 187)

Housing (UNIT : mm)

接插件护套(毫米)

Ref: Terminal part No. [0.64mm] A-02
端子参照页 [4.8mm] A-14

Material PBT
材质

No. of way/ () corresponds to 0.64mm, 4.8mm, in order from left to right.
极数/ () 内显示: 从左向右为0.64mm 极数、4.8mm 极数

20way (18+2)

F (6098-5903)

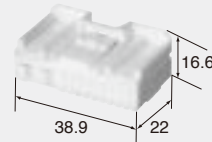

Color Natural
颜色 自然色

2.3mm, 4.8mm (090, 187)

Housing (UNIT : mm)

接插件护套(毫米)

Ref: Terminal part No. [2.3mm] A-10
端子参照页 [4.8mm] A-14

Material PBT
材质

No. of way/ () corresponds to 2.3mm, 4.8mm, in order from left to right.
极数/ () 内显示: 从左向右为2.3mm 极数、4.8mm 极数

14way (12+2)

Color Natural
颜色 自然色

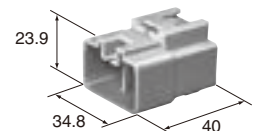

M (6241-0261)

F (6245-0281)

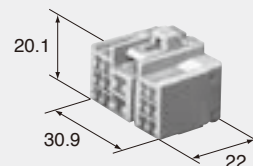

Color Natural
颜色 自然色

15way (12+3)

Color Natural
颜色 自然色

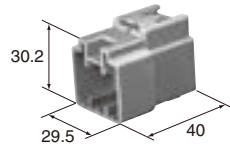

M (6241-0241)

F (6245-0261)

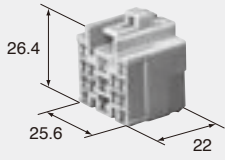

Color Natural
颜色 自然色

20way (18+2)

Color Natural
颜色 自然色

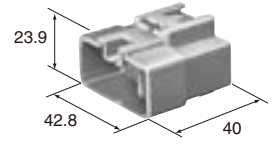

M (6241-0281)

F (6245-0301)

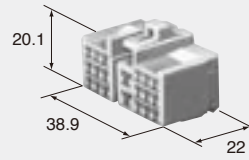

Color Natural
颜色 自然色

0.64mm (025)

TS SERIES for PCB

Housing (UNIT : mm)

接插件护套(毫米)

16way

M (6098-6790)

Connector F part No. 母端接插件产品号码	6098-4008 (A-05)
Material 材质	PBT
Color 颜色	Natural 自然色

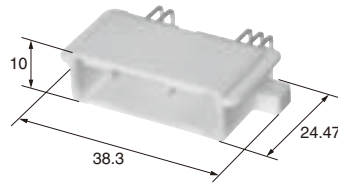

● Detailed dimension
详细尺寸

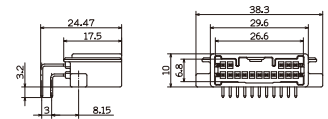

● Recommended dimension of Circuit board
电路板推荐尺寸

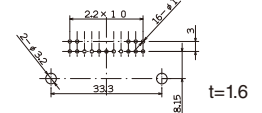

16way

M (6098-6793)

Connector F part No. 母端接插件产品号码	6098-4008 (A-05)
Material 材质	SPS
Color 颜色	Natural 自然色

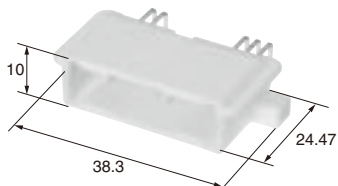

● Detailed dimension
详细尺寸

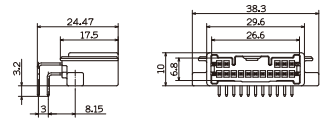

● Recommended dimension of Circuit board
电路板推荐尺寸

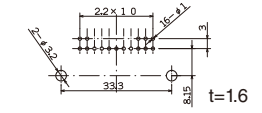

33way

M (6098-7229)

Connector F part No. 母端接插件产品号码	6098-7231 (A-05) 6098-7241 (A-04)
Material 材质	SPS
Color 颜色	Natural 自然色

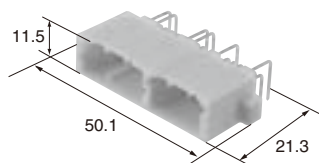

● Detailed dimension
详细尺寸

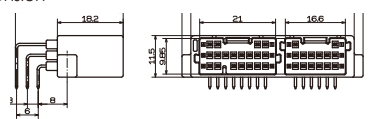

● Recommended dimension of Circuit board
电路板推荐尺寸

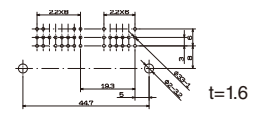

36way

M (6098-6796)

Connector F part No. 母端接插件产品号码	6098-4740(A-06)
Material 材质	PBT
Color 颜色	Natural 自然色

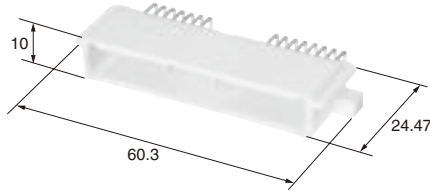

●Detailed dimension
详细尺寸

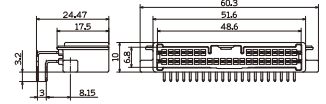

●Recommended dimension of Circuit board
电路板推荐尺寸

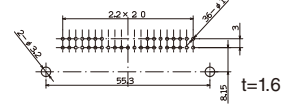

36way

M (6098-6798)

Connector F part No. 母端接插件产品号码	6098-4740(A-06)
Material 材质	SPS
Color 颜色	Natural 自然色

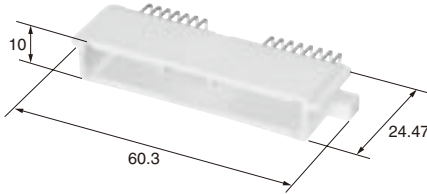

●Detailed dimension
详细尺寸

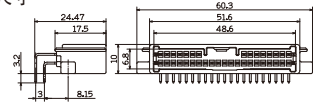

●Recommended dimension of Circuit board
电路板推荐尺寸

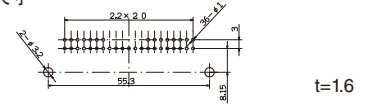

56way (16+16+24)

M (6098-6848)

Connector F part No. 母端接插件产品号码	6098-6688(A-05) 6098-6694(A-05) 6098-6682(A-05)
Material 材质	SPS
Color 颜色	Natural 自然色

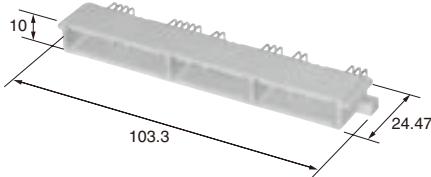

●Detailed dimension
详细尺寸

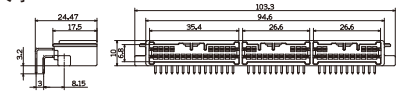

●Recommended dimension of Circuit board
电路板推荐尺寸

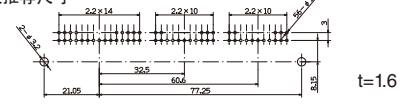

60way (36+24)

M (6098-6803)

Connector F part No. 母端接插件产品号码	6098-4010(A-05) 6098-4740(A-06)
Material 材质	SPS
Color 颜色	Natural 自然色

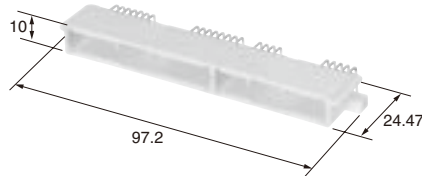

●Detailed dimension
详细尺寸

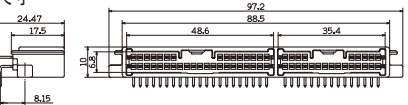

●Recommended dimension of Circuit board
电路板推荐尺寸

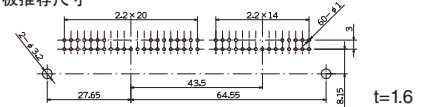

68way (40+28)

M (6098-6805)

Connector F part No. 母端接插件产品号码	6098-4756(A-05) 6098-4831(A-06)
Material 材质	PBT
Color 颜色	Natural 自然色

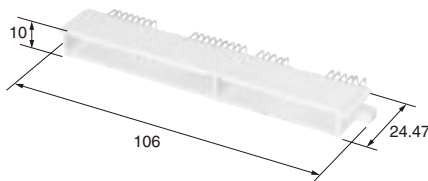

●Detailed dimension
详细尺寸

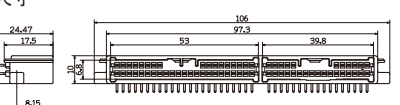

●Recommended dimension of Circuit board
电路板推荐尺寸

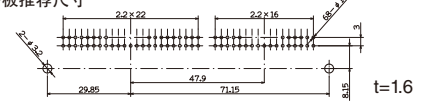

TS SEALED SERIES

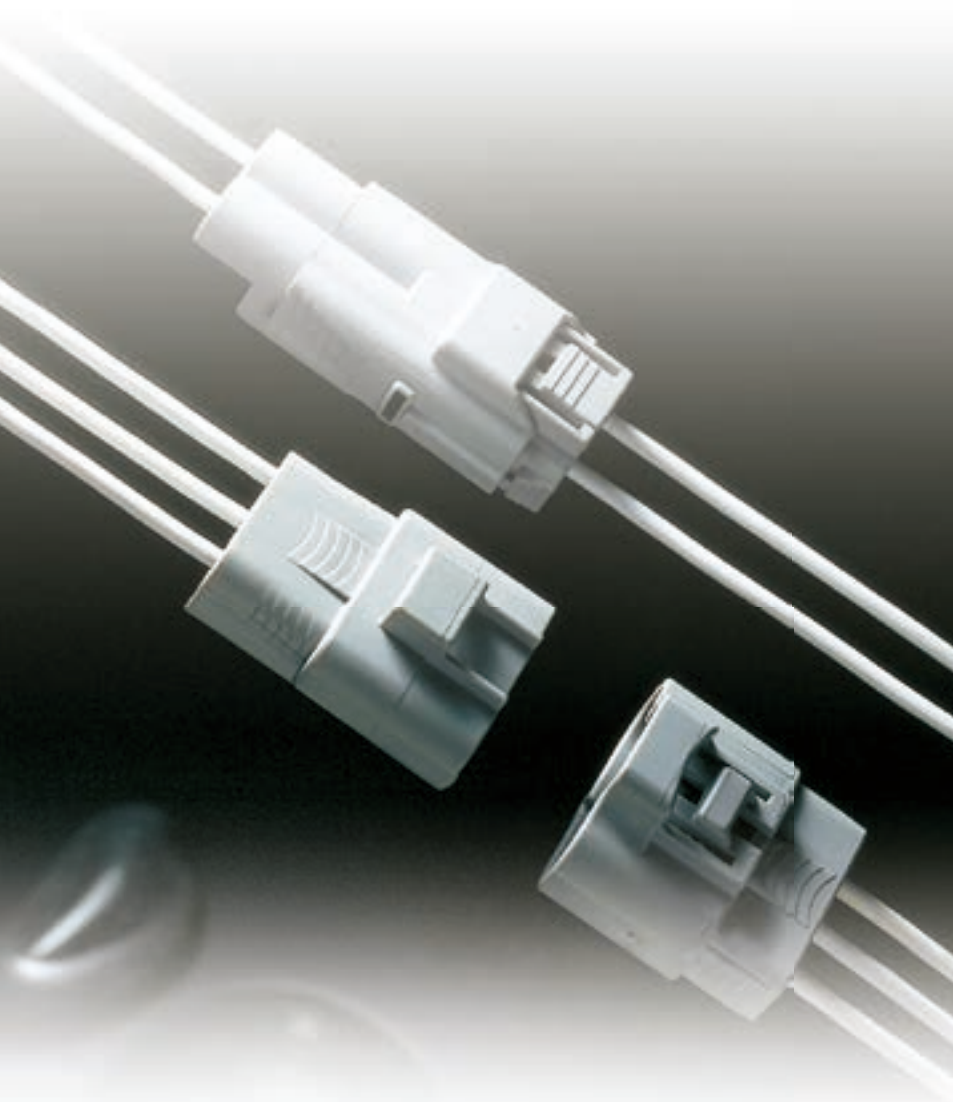

Features

The TS sealed connector series has a mechanism of terminal position assurance. This series consists of 0.64mm, 2.3mm, 4.8mm and 8.0mm types classified according to terminal size, covering an extensive array of applications from signal to power circuits.

- Retainers are pre-mounted on the connector housing, and are structured to enable setting by the same simple operation regardless of the number of ways, improving operability.
- These connectors can be directly secured to a bracket on the car body.
- RoHS/ELV Compliant

特点

TS防水系列接插件具有检测端子插入不足的结构。按照端子尺寸划分为0.64mm·2.3mm·4.8mm·8.0mm，从信号回路到电源回路，能广泛应用。

- 锁片预先组装在接插件护套上，无论多少极数都能通过简单操作组合，有助于提高操作效率。
- 接插件可以直接固定在车体的支架上。
- 可对应欧盟 RoHS 和 ELV 指令

TS SEALED SERIES for STANDARD

0.64mm (025)

Structure / 构造

B-02

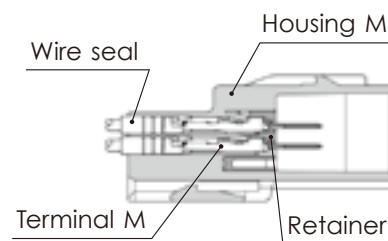
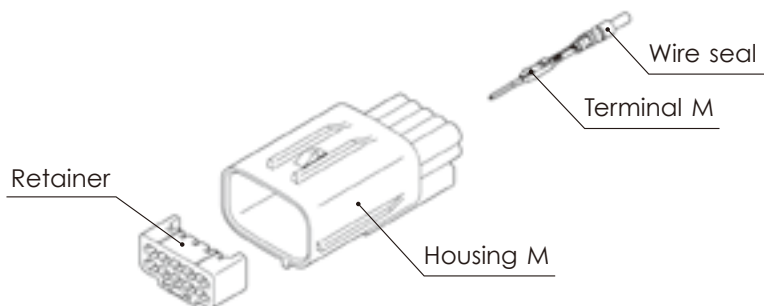

Connector M

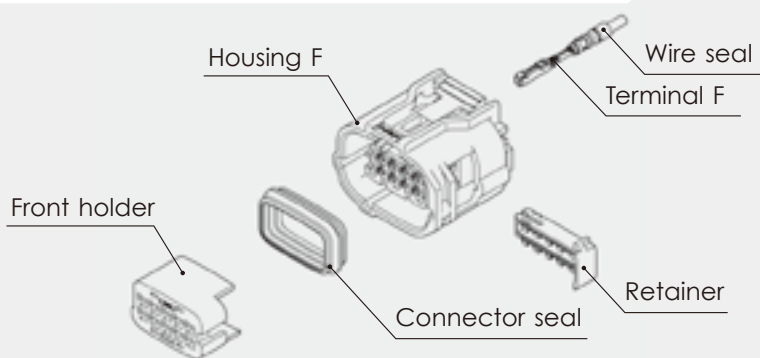

Connector F

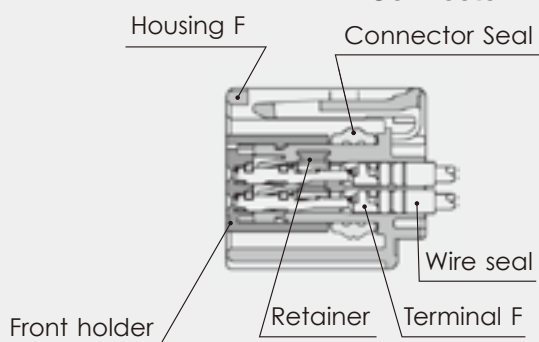

0.64mm (025)

Terminal (UNIT : mm)

端子 (毫米)

(S)

F (8240-0336)

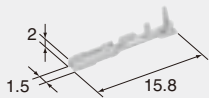

Cable size (mm ²) 适用电线大小	0.13
---	------

Material 材质	Heat-resistant copper alloy
----------------	-----------------------------

Surface treatment 表面处理	Tin-plated 镀锡
---------------------------	------------------

(S)

Au

F (8240-0337)

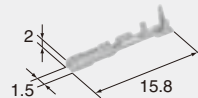

Cable size (mm ²) 适用电线大小	0.13
---	------

Material 材质	Heat-resistant copper alloy
----------------	-----------------------------

Surface treatment 表面处理	Gold-plated 镀金
---------------------------	-------------------

(M)

Cable size (mm ²) 适用电线大小	0.22~0.5
---	----------

Material 材质	Brass 黄铜
----------------	-------------

Surface treatment 表面处理	Tin-plated 镀锡
---------------------------	------------------

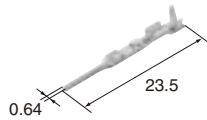

(M)

Au

Cable size (mm ²) 适用电线大小	0.22~0.5
---	----------

Material 材质	Brass 黄铜
----------------	-------------

Surface treatment 表面处理	Gold-plated 镀金
---------------------------	-------------------

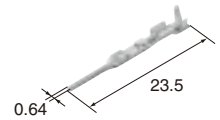

M (8100-3617)

F (8100-3455)

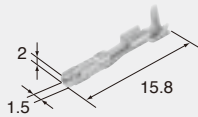

Cable size (mm ²) 适用电线大小	0.22~0.35
---	-----------

Material 材质	Heat-resistant copper alloy
----------------	-----------------------------

Surface treatment 表面处理	Tin-plated 镀锡
---------------------------	------------------

M (8100-3708)

F (8100-3456)

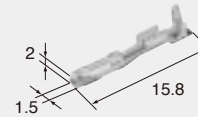

Cable size (mm ²) 适用电线大小	0.22~0.35
---	-----------

Material 材质	Heat-resistant copper alloy
----------------	-----------------------------

Surface treatment 表面处理	Gold-plated 镀金
---------------------------	-------------------

(L)

F (8240-0287)

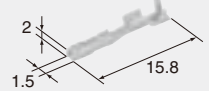

Cable size (mm ²) 适用电线大小	0.5
---	-----

Material 材质	Heat-resistant copper alloy
----------------	-----------------------------

Surface treatment 表面处理	Tin-plated 镀锡
---------------------------	------------------

(L)

Au

F (8240-0288)

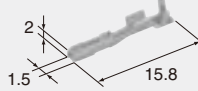

Cable size (mm ²) 适用电线大小	0.5
---	-----

Material 材质	Heat-resistant copper alloy
----------------	-----------------------------

Surface treatment 表面处理	Gold-plated 镀金
---------------------------	-------------------

0.64mm (025)

B-04

Wire seals (UNIT : mm)

电线密封栓(毫米)

- The wire seals are common to M and F.
*A wireseal depends on a chosen cable.
- 电线密封栓为公端、母端共用。
- ※不同的电线使用不同的电线密封栓。

(SS)

(7165-1043)

Cable size (mm ²) 适用电线大小	(CHFUS/0.22)
Cable overall diameter(mm) 带绝缘层外径	0.95~1.05
Material 材质	Silicon 硅
Color 颜色	Green 绿

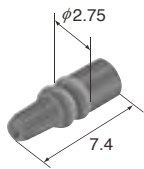

(3S)

(7165-1423)

Cable size (mm ²) 适用电线大小	(CHFUS/0.13)
Cable overall diameter(mm) 带绝缘层外径	0.85~0.95
Material 材质	Silicon 硅
Color 颜色	Light Brown 浅棕

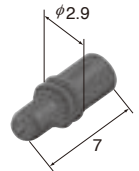

(S)

(7165-1312)

Cable size (mm ²) 适用电线大小	(CHFUS/0.35~0.5)
Cable overall diameter(mm) 带绝缘层外径	1.1~1.4
Material 材质	Silicon 硅
Color 颜色	Violet 紫

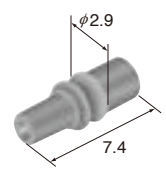

(M)

(7165-1198)

Cable size (mm ²) 适用电线大小	(AVSS/0.3) (AVSSH/0.3) (AESSX/0.3)
Cable overall diameter(mm) 带绝缘层外径	1.4~1.5
Material 材质	Silicon 硅
Color 颜色	Dark Yellow 深黄色

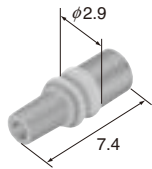

(L)

(7165-1199)

Cable size (mm ²) 适用电线大小	(AVSS/0.5) (AVSSH/0.5) (AVSSX/0.5) (AESSX/0.5)
Cable overall diameter(mm) 带绝缘层外径	1.6~1.7
Material 材质	Silicon 硅
Color 颜色	Red Violet 紫红

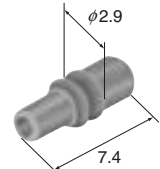

0.64mm (025)

Dummy plugs (UNIT : mm)

盲塞(毫米)

- Dummy plugs are common to M and F.
- Dummy plugs are used to blind unused terminal holes.
- 盲塞为公端、母端共用。
- 盲塞用于堵塞不使用的端子孔。

(7165-0797)

Material 材质	NBR
Color 颜色	Light Gray 浅灰



0.64mm (025)

Housing (UNIT : mm)

接插件护套(毫米)

Ref: Terminal part No. B-03
端子参照页

Ref: wire seal No. B-04
电线密封栓参照页

Ref: Dummy plug No. B-04
盲塞参照页

Material PBT
材质

2way

Color Black
颜色 黑

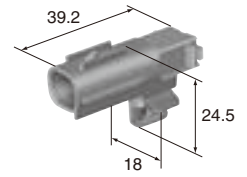

M (6188-4797)

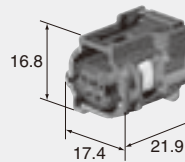

F (6189-1161)

Color Black
颜色 黑

2way

F (6189-7020)

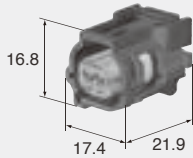

Color Black
颜色 黑

3way

Color Black
颜色 黑

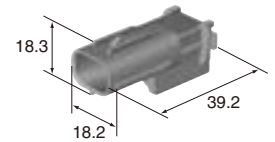

M (6188-4920)

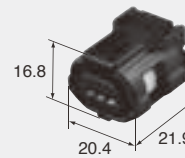

F (6189-1129)

Color Black
颜色 黑

2way

F (6189-7073)

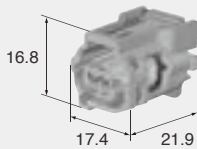

Color Gray
颜色 灰

4way

F (6189-1132)

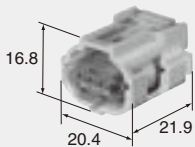

Color Gray
颜色 灰

4way

F (6189-1231)

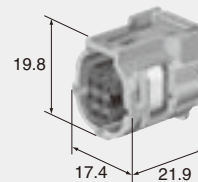

Color Gray
颜色 灰

4way

F (6189-7401)

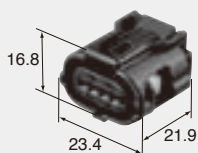

Color Black
颜色 黑

5way

F (6189-1046)

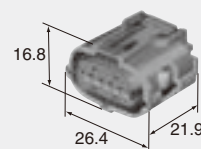

Color Black
颜色 黑

6way

Color
颜色 Natural
自然色

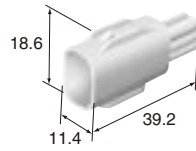

6way

F (6189-1083)

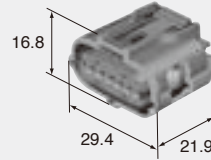

Color
颜色 Black
黑

M (6188-0706)

F (6189-1142)

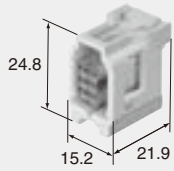

Color
颜色 Natural
自然色

6way

F (6189-7100)

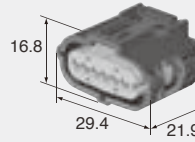

Color
颜色 Black
黑

8way

Color
颜色 Gray
灰

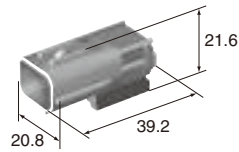

M (6188-0779)

F (6189-1240)

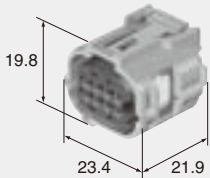

Color
颜色 Gray
灰

10way

Color
颜色 Black
黑

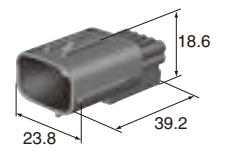

M (6188-0696)

F (6189-1134)

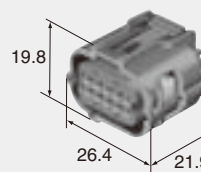

Color
颜色 Black
黑

12way

F (6189-1128)

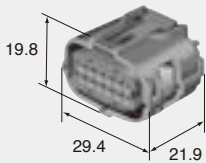

Color
颜色 Black
黑

13way

Color
颜色 Gray
灰

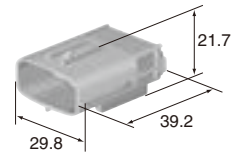

12way

F (6189-1133)

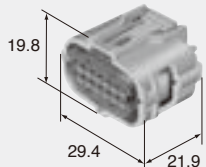

Color
颜色 Gray
灰

M (6188-4914)

F (6189-1092)

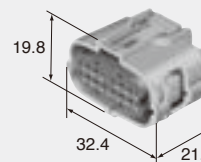

Color
颜色 Gray
灰

15way **F (6189-1135)**

Color: Gray
颜色: 灰

17way **F (6189-7110)**

Color: Gray
颜色: 灰

20way **F (6189-7167)**

Color: Black
颜色: 黑

30way **F (6189-6987)**

Color: Gray
颜色: 灰

B-07

TS SEALED SERIES

TS SEALED SERIES for STANDARD

0.64W (025W)

Structure / 构造

B-08

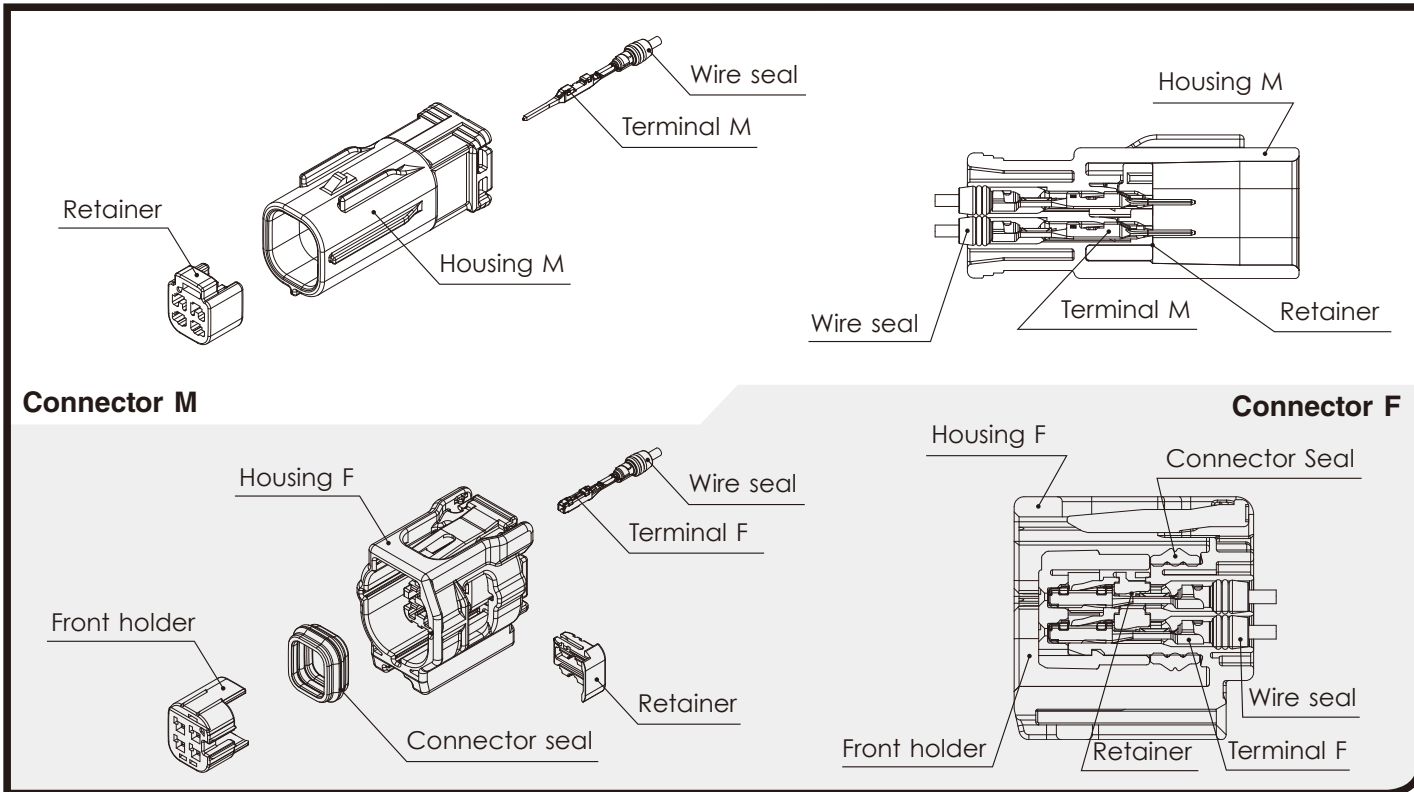

防水0.64W型接插件与0.64型相比，因为扩大了端子孔腔间的距离，所以不具备互换性。

(为了区别于现有的防水0.64型，称呼为防水0.64W型。)

Since 0.64W has wider terminal pitch, there is no compatibility between 0.64 and 0.64W.

(These connectors are called "0.64W series" to distinguish from existing 0.64 series.)

0.64W (025W)

Terminal (UNIT: mm)

端子(毫米)

Ref; 0.64mm Terminal detail

0.64mm端子参照页

M(Sn) M (8100-3617) B-03 **F (8100-3455)** B-03

M(Au) M (8100-3708) B-03 **F (8100-3456)** B-03

(LL)

Cable size (mm²)
适用电线大小

FPW/0.6	CIVUS/0.5
AVSS/0.5	AVSSX/0.5
AVSSH/0.5	IVSSH/0.5
AESSX/0.5	CHFUS/0.5
HFSS/0.5	

Material
材质

Brass
黄铜

Surface treatment
表面处理

Tin-plated
镀锡

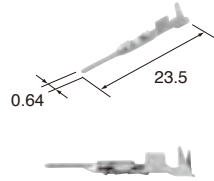
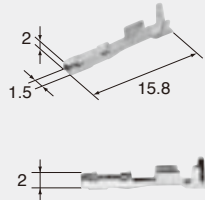
**M (8230-5360)**

Cable size (mm²)
适用电线大小

FPW/0.6	CIVUS/0.5
AVSS/0.5	AVSSX/0.5
AVSSH/0.5	IVSSH/0.5
AESSX/0.5	CHFUS/0.5
HFSS/0.5	

Material
材质

Heat resistant copper-alloy
耐热铜合金

Surface treatment
表面处理

Tin-plated
镀锡

F (8240-0500)**(LL)****Au**

Cable size (mm²)
适用电线大小

CIVUS/0.5	AVSS/0.5
AVSSX/0.5	AVSSH/0.5
IVSSH/0.5	AESSX/0.5
CHFUS/0.5	HFSS/0.5

Material
材质

Brass
黄铜

Surface treatment
表面处理

Gold-plated
镀金

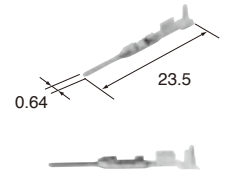
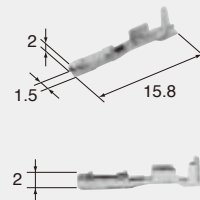
**M (8230-5361)**

Cable size (mm²)
适用电线大小

CIVUS/0.5	AVSS/0.5
AVSSX/0.5	AVSSH/0.5
IVSSH/0.5	AESSX/0.5
CHFUS/0.5	HFSS/0.5

Material
材质

Heat resistant copper-alloy
耐热铜合金

Surface treatment
表面处理

Gold-plated
镀金

F (8240-0501)

0.64W (025W)

Wire seals (UNIT : mm)

电线密封栓(毫米)

The wire seals are common to M and F.

电线密封栓为公端、母端共用。

(S)**(7165-1608)**

Cable size (mm²)
适用电线大小

CIVUS/0.35~0.5
CHFUS/0.35~0.5

Cable overall diameter (mm)
带绝缘层外径

1.1~1.4

Material
材质

Silicon
硅

Color
颜色

Dark Gray
深灰

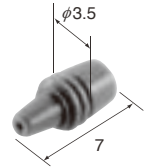
**(M)****(7165-1607)**

Cable size (mm²)
适用电线大小

AVSS/0.3	AVSSH/0.3
IVSSH/0.35	HFSS/0.35

Cable overall diameter (mm)
带绝缘层外径

1.3~1.5

Material
材质

Silicon
硅

Color
颜色

Dark Green
墨绿

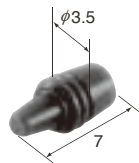
**(L)****(7165-1606)**

Cable size (mm²)
适用电线大小

FPW/0.6	AVSS/0.5
AVSSX/0.5	AVSSH/0.5
IVSSH/0.5	HFSS/0.5

Cable overall diameter (mm)
带绝缘层外径

1.51~1.73

Material
材质

Silicon
硅

Color
颜色

Dark Brown
深棕

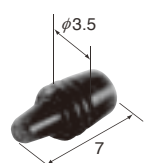

0.64W (025W)

B-10

Dummy plugs (UNIT : mm)

盲塞(毫米)

- Dummy plugs are common to M and F.
- Dummy plugs are used to blind unused terminal holes.
- 盲塞为公端、母端共用。
- 盲塞用于堵塞不使用的端子孔。

0.64W (025W)

Housing (UNIT : mm)

接插件护套(毫米)

Ref: Terminal part No. B-08
端子参照页

Ref: wire seal No. B-09
电线密封栓参照页

Ref: Dummy plug No. B-10
盲塞参照页

Material PA6T
材质

TS SEALED SERIES
for HYBRID

(7165-1605)

Material Silicon
材质 硅

Color Indian Red
颜色 印度红

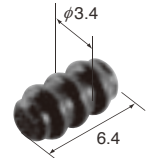

4way

Color Black
颜色 黑

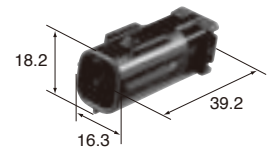

M (6188-5516)

F (6189-7449)

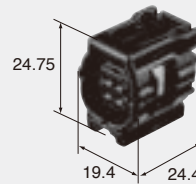

Color Black
颜色 黑

0.64W, 2.3mm, 4.8mm (025W, 090, 187)

Housing (UNIT : mm)

接插件护套(毫米)

Ref: Terminal part No. [0.64W] B-08
端子参照页 [2.3mm] B-13(for P06)
[4.8mm] B-19

Ref: wire seal No. [0.64W] B-09
电线密封栓参照页 [2.3mm] B-14(for P06)
[4.8mm] B-20

Ref: Dummy plug No. [0.64W] B-10
盲塞参照页 [2.3mm] B-15(for P06)
[4.8mm] B-21

Material PBT
材质

No. of way/ () corresponds to 0.64W, 2.3mm, 4.8mm in order from left to right.
极数/ () 内显示: 从左向右为0.64mm 极数、2.3mm 极数、4.8mm 极数

38way (34+2+2) Slide Lever
F (6189-7435)

29.9
41.7
80.3

Color Black
颜色 黒

38way (34+2+2) Slide Lever
F (6189-7436)

29.9
41.7
80.3

Color Black
颜色 黒

38way (34+2+2) Swing + Slide Lever
F (6189-7433)

29.9
37.3
77.3

Color Black
颜色 黒

38way (34+2+2) Swing + Slide Lever
F (6189-7434)

29.9
37.3
77.3

Color Black
颜色 黒

Lever Assy
F (6911-5774)

88.3
43.5
31.2

Color Black
颜色 黒

46way (38+4+4) Slide Lever
F (6189-7546)

29.9
43.6
95.5

Color Black
颜色 黒

46way (38+4+4) Slide Lever
F (6189-7547)

29.9
43.6
95.5

Color Black
颜色 黒

TS SEALED SERIES for STANDARD

2.3mm (090)

Structure / 构造

B-12

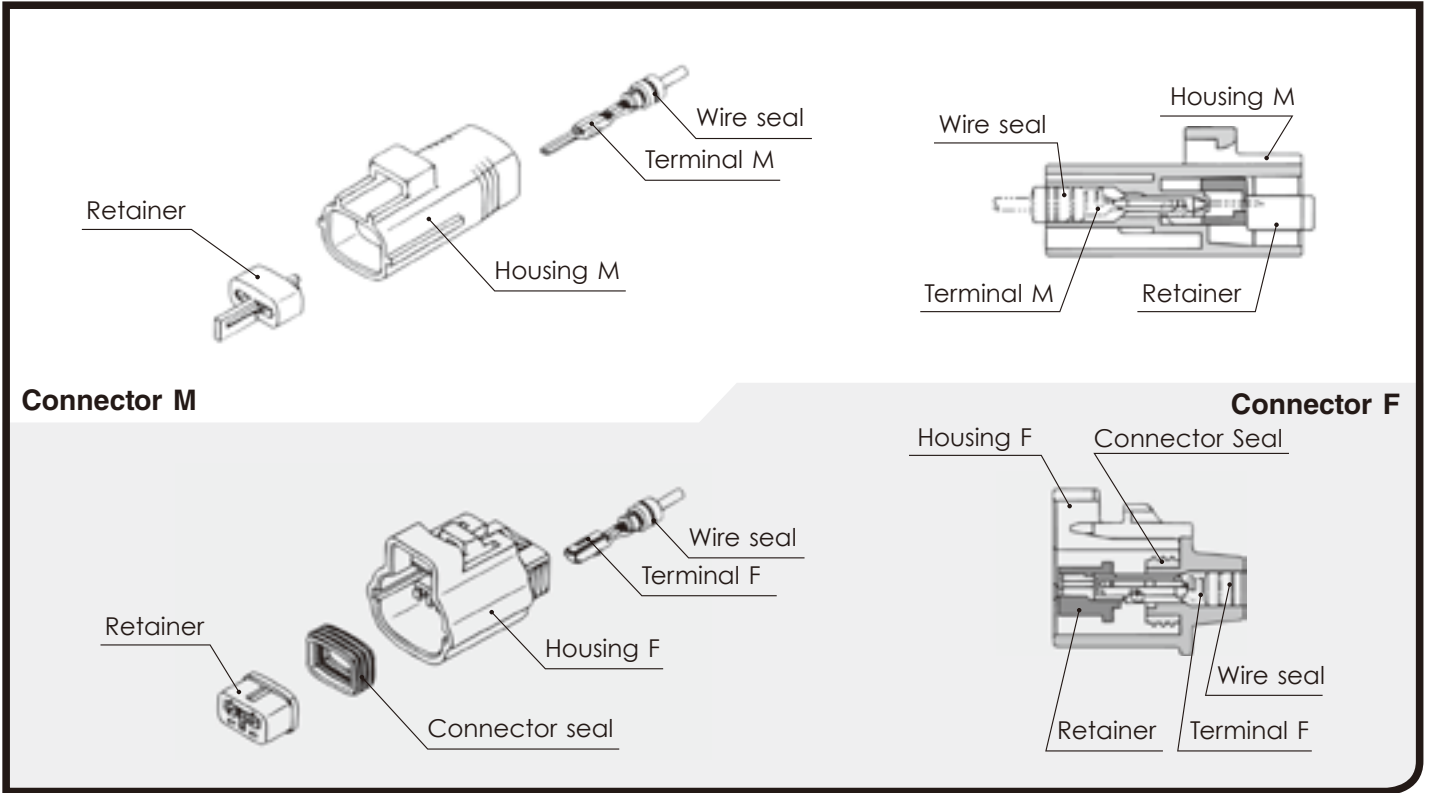

2.3mm (090)

Terminal (UNIT : mm)

端子(毫米)

(S)

Cable size (mm²) 适用电线大小	0.3~0.5
Material 材质	Brass 黄铜
Surface treatment 表面处理	Tin-plated 镀锡

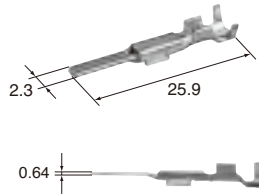
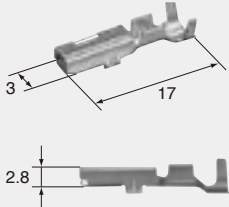
**M (8100-0457)**

Cable size (mm²) 适用电线大小	0.3~0.5
Material 材质	Heat-resistant copper alloy
Surface treatment 表面处理	Tin-plated 镀锡

F (8100-0460)**(S)**

Cable size (mm²) 适用电线大小	0.3~0.5
Material 材质	Brass 黄铜
Surface treatment 表面处理	Gold-plated 镀金

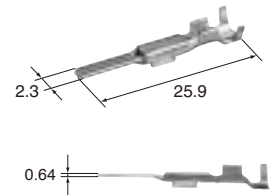
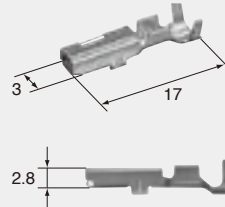
**M (8100-1340)**

Cable size (mm²) 适用电线大小	0.3~0.5
Material 材质	Heat-resistant copper alloy
Surface treatment 表面处理	Gold-plated 镀金

F (8100-1344)**(M)**

Cable size (mm²) 适用电线大小	0.5~1.25
Material 材质	Brass 黄铜
Surface treatment 表面处理	Tin-plated 镀锡

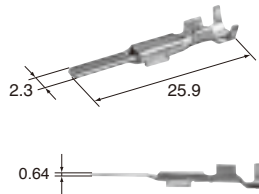
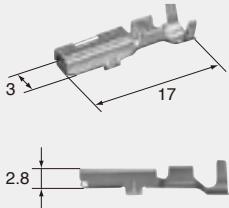
**M (8100-0458)**

Cable size (mm²) 适用电线大小	0.5~1.25
Material 材质	Heat-resistant copper alloy
Surface treatment 表面处理	Tin-plated 镀锡

F (8100-0461)**(M)**

Cable size (mm²) 适用电线大小	0.5~1.25
Material 材质	Brass 黄铜
Surface treatment 表面处理	Gold-plated 镀金

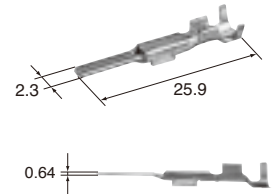
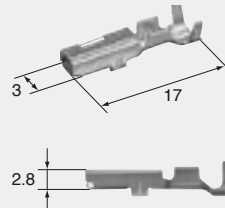
**M (8100-1007)**

Cable size (mm²) 适用电线大小	0.5~1.25
Material 材质	Heat-resistant copper alloy
Surface treatment 表面处理	Gold-plated 镀金

F (8100-0594)**(L)**

Cable size (mm²) 适用电线大小	2.0
Material 材质	Brass 黄铜
Surface treatment 表面处理	Tin-plated 镀锡

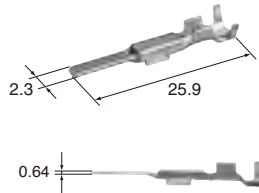
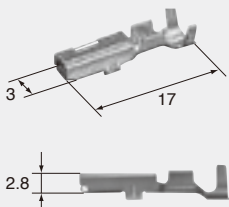
**M (8100-0459)**

Cable size (mm²) 适用电线大小	2.0
Material 材质	Heat-resistant copper alloy
Surface treatment 表面处理	Tin-plated 镀锡

F (8100-0462)**(L)**

Cable size (mm²) 适用电线大小	2.0
Material 材质	Brass 黄铜
Surface treatment 表面处理	Gold-plated 镀金

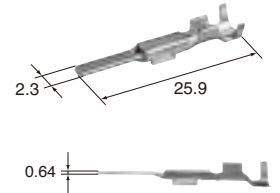
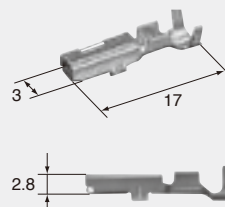
**M (8100-1008)**

Cable size (mm²) 适用电线大小	2.0
Material 材质	Heat-resistant copper alloy
Surface treatment 表面处理	Gold-plated 镀金

F (8100-0817)

2.3mm (090)

Wire seals (UNIT : mm)

电线密封栓(毫米)

The wire seals are common to M and F.

- P5 : For 5mm pitch housing/Please inquire us for the details.
- P6 : For 6mm pitch housing

电线密封栓为公端、母端共用。

- P5 : 5mm 间距用 / 请另行咨询。
- P6 : 6mm 间距用

(SS)

(P6)

(7165-0842)

Cable size (mm²) (适用电线大小) (CHFUS/0.35~0.5)

Cable overall diameter (mm) (带绝缘层外径) 1.1~1.4

Material (材质) Silicon (硅)

Color (颜色) Blue (蓝)

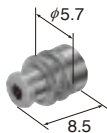

(S)

(P6)

(7165-0349)

Cable size (mm²) (适用电线大小) (AVX·AEX/0.3) (AVS/0.3) (AVSS/0.3~0.85) (AVSSX·AESSX/0.3~0.75) (CAVUS/0.85~1.25)

Cable overall diameter (mm) (带绝缘层外径) 1.4~2.0

Material (材质) Silicon (硅)

Color (颜色) Dark Brown (深棕)

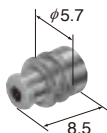

(S)

(P5)

(7165-0342)

Cable size (mm²) (适用电线大小) (AVX·AEX/0.3) (AVS/0.3) (AVSS/0.3~0.85) (AVSSX·AESSX/0.3~0.75) (CAVUS/0.85~1.25)

Cable overall diameter (mm) (带绝缘层外径) 1.4~2.0

Material (材质) Silicon (硅)

Color (颜色) Brown (棕)

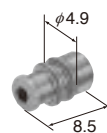

(M)

(P6)

(7165-0395)

Cable size (mm²) (适用电线大小) (AV/0.5) (AVX·AEX/0.5~0.75) (AVS/0.5~0.85) (AVSS/1.25) (AVSSX·AESSX/1.25)

Cable overall diameter (mm) (带绝缘层外径) 2.0~2.5

Material (材质) Silicon (硅)

Color (颜色) Dark Green (墨绿)

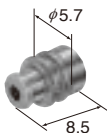

(M)

(P5)

(7165-0343)

Cable size (mm²) (适用电线大小) (AV/0.5) (AVX·AEX/0.5~0.75) (AVS/0.5~0.85) (AVSS/1.25) (AVSSX·AESSX/1.25)

Cable overall diameter (mm) (带绝缘层外径) 2.0~2.5

Material (材质) Silicon (硅)

Color (颜色) Black (黑)

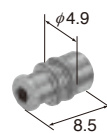

(L)

(P6)

(7165-0351)

Cable size (mm²) (适用电线大小) (AV/1.25) (AVX·AEX/1.25) (AVS/1.25) (AVSS/2.0) (AVSSX·AESSX/2.0)

Cable overall diameter (mm) (带绝缘层外径) 2.5~2.9

Material (材质) Silicon (硅)

Color (颜色) Dark Gray (深灰)

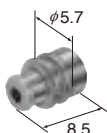

(L)

(P5)

(7165-0344)

Cable size (mm²) (适用电线大小) (AV/1.25) (AVX·AEX/1.25) (AVS/1.25) (AVSS/2.0) (AVSSX·AESSX/2.0)

Cable overall diameter (mm) (带绝缘层外径) 2.5~2.9

Material (材质) Silicon (硅)

Color (颜色) Dark Blue (藏青)

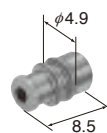

2.3mm (090)

Dummy plugs (UNIT : mm)

盲塞 (毫米)

- Dummy plugs are common to M and F.
- Dummy plugs are used to blind unused terminal holes.
- P5 : For 5mm pitch housing/Please inquire us for the details.
- P6 : For 6mm pitch housing
- 盲塞为公端、母端共用。
- 盲塞用于堵塞不使用的端子孔。
- P5 : 5mm 间距用 / 请另行咨询。
- P6 : 6mm 间距用

2.3mm (090)

Housing (UNIT : mm)

接插件护套 (毫米)

Ref: Terminal part No. B-13
端子参照页

Ref: wire seal No. B-14
电线密封栓参照页

Ref: Dummy plug No. B-15
盲塞参照页

Material PBT
材质

2way

Color Gray
颜色

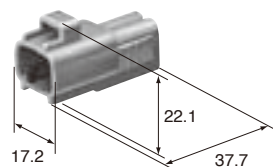

M (6188-0108)

F (6189-0199)

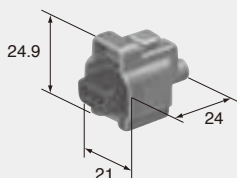

Color Gray
颜色

(P6)

(7160-9465)

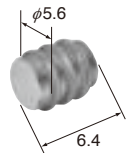

Material NBR
材质
Color Black
颜色

(P5)

(7161-9787)

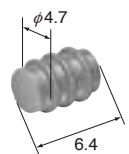

Material NBR
材质
Color Brown
颜色

2way

Color Gray
颜色

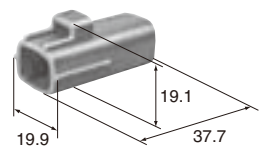

M (6188-0047)

F (6189-0100)

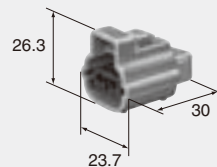

Color Gray
颜色

2way

Color Gray
颜色

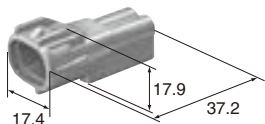

M (6188-0266)

F (6189-0249)

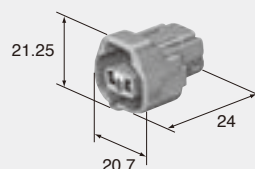

Color Gray
颜色

2way

Color	Gray
颜色	灰

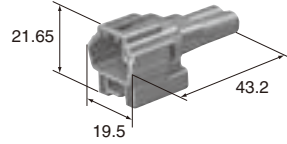
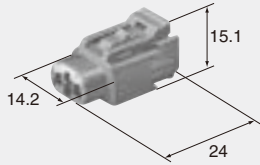
**M (6188-0229)****F (6189-0388)**

Color	Gray
颜色	灰

2way

Color	Natural
颜色	自然色

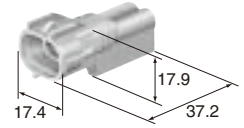
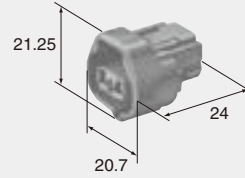
**M (6188-0624)****F (6189-0264)**

Color	Gray
颜色	灰

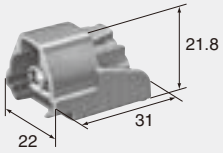
2way**P5****F (6189-0566)**

Ref: Wire seal No.	B-10 (For P5)
电线密封栓参照页	

Ref: Dummy plug No.	B-11 (For P5)
盲塞参照页	

Color	Gray
颜色	灰

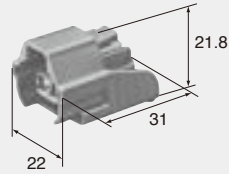
2way**P5****F (6189-0573)**

Ref: Wire seal No.	B-10 (For P5)
电线密封栓参照页	

Ref: Dummy plug No.	B-11 (For P5)
盲塞参照页	

Color	Gray
颜色	灰

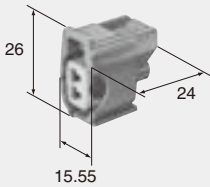
2way**P5****F (6189-0611)**

Ref: Wire seal No.	B-10 (For P5)
电线密封栓参照页	

Ref: Dummy plug No.	B-11 (For P5)
盲塞参照页	

Color	Gray
颜色	灰

2way

Color	Gray
颜色	灰

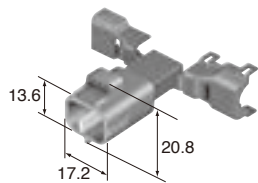
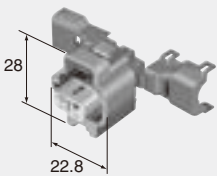
**M (6188-0470)****F (6189-0682)**

Color	Gray
颜色	灰

3way (T Type)

Color	Gray
颜色	灰

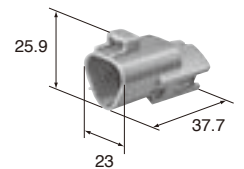
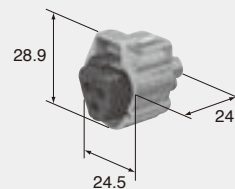
**M (6188-0099)****F (6189-0179)**

Color	Gray
颜色	灰

3way (E Type)

Color 灰
颜色 灰

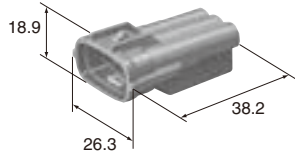

M (6188-0282)

F (6189-0443)

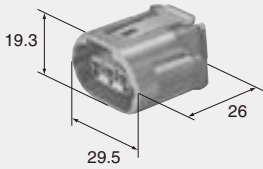

Color 灰
颜色 灰

4way

Color 黑
颜色 黑

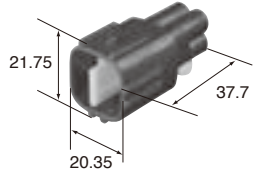

M (6188-0517)

F (6189-0629)

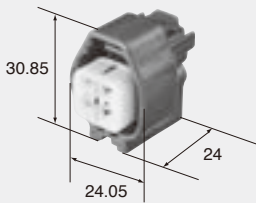

Color 灰
颜色 灰

4way

Color 灰
颜色 灰

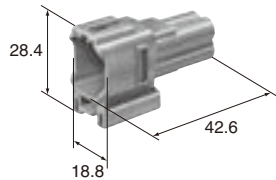

M (6188-0141)

F (6189-0381)

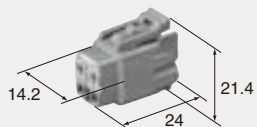

Color 灰
颜色 灰

4way

F (6189-0694)

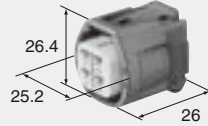

Color 黑
颜色 黑

4way

F (6189-7398)

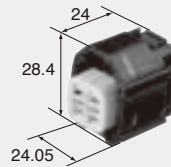

Material PA6T
颜色 黑

4way

Color 灰
颜色 灰

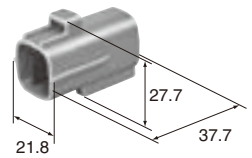

M (6188-0066)

F (6189-0126)

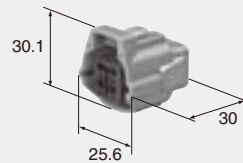

Color 灰
颜色 灰

4way

Color 灰
颜色 灰

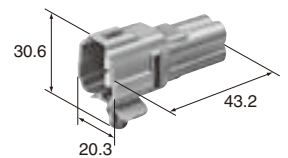
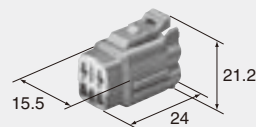

Plate thickness range for clamp:
t=0.7~2.2

M (6188-0217)

F (6189-0372)



Color 灰
颜色 灰

4way

Color 灰
颜色 灰

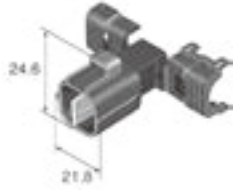

M (6188-0472)

F (6189-0685)

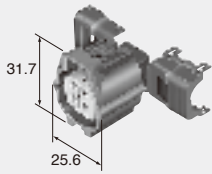

Color 灰
颜色 灰

5way

Color 灰
颜色 灰

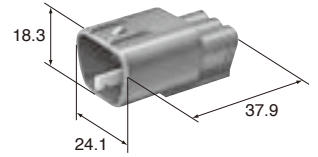

M (6188-0327)

F (6189-0504)

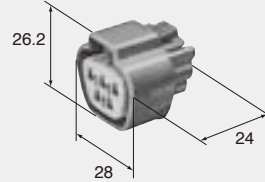

Color 灰
颜色 灰

6way

Color 灰
颜色 灰

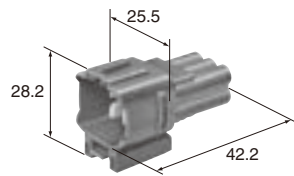

M (6188-0173)

F (6189-0319)

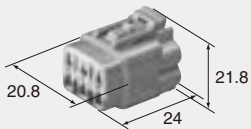

Color 灰
颜色 灰

6way

Color 灰
颜色 灰

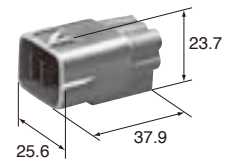

M (6188-0175)

F (6189-0323)

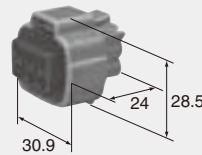

Color 灰
颜色 灰

6way

Color 灰
颜色 灰

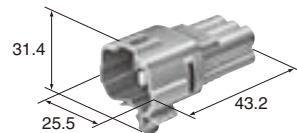
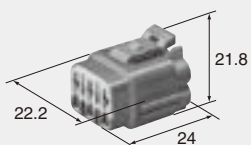

Plate thickness range for clamp:
 $t=0.7\sim 2.2$

M (6188-0209)

F (6189-0368)



Color 灰
颜色 灰

7way

Color 灰
颜色 灰

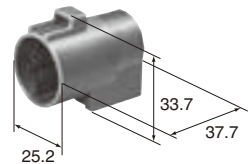

M (6188-0067)

F (6189-0127)

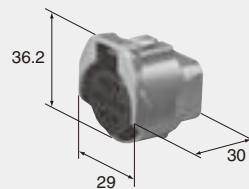

Color 灰
颜色 灰

TS SEALED SERIES for STANDARD

4.8mm (187)

Structure / 构造

B-19

TS SEALED SERIES

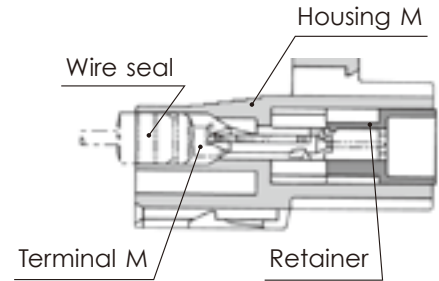
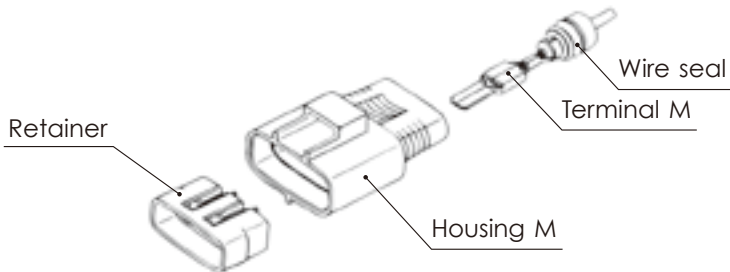

Connector M

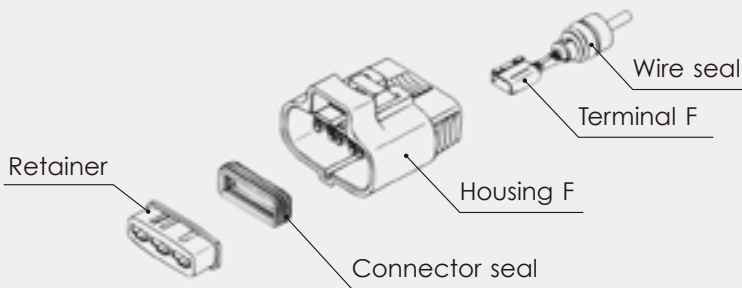

Connector F

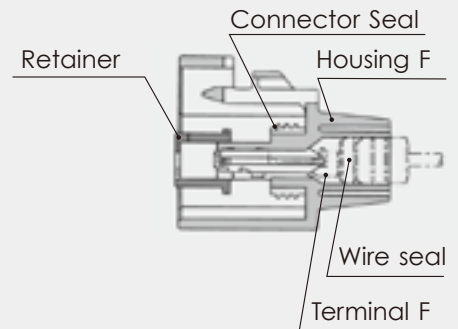

4.8mm (187)

(S)

Cable size (mm ²) 适用电线大小	0.3~0.5
Material 材质	Brass 黄铜
Surface treatment 表面处理	Tin-plated 镀锡

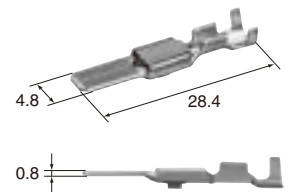

M (8100-0463)

F (8100-0466)

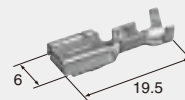

Cable size (mm ²) 适用电线大小	0.3~0.5
Material 材质	Brass 黄铜
Surface treatment 表面处理	Tin-plated 镀锡

Terminal (UNIT: mm)

端子(毫米)

(M)

Cable size (mm ²) 适用电线大小	0.5~1.25
Material 材质	Brass 黄铜
Surface treatment 表面处理	Tin-plated 镀锡

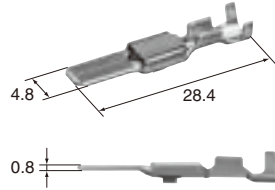
**(L)**

Cable size (mm ²) 适用电线大小	2.0~3.0
Material 材质	Brass 黄铜
Surface treatment 表面处理	Tin-plated 镀锡

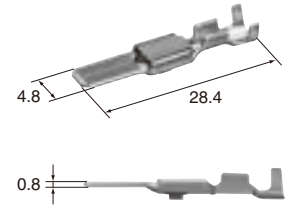
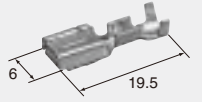
**B-20****M (8100-0464)****F (8100-0467)**

Cable size (mm ²) 适用电线大小	0.5~1.25
Material 材质	Brass 黄铜
Surface treatment 表面处理	Tin-plated 镀锡

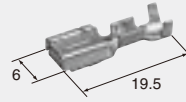
M (8100-0465)**F (8100-0468)**

Cable size (mm ²) 适用电线大小	2.0~3.0
Material 材质	Heat-resistant copper alloy
Surface treatment 表面处理	Tin-plated 镀锡

4.8mm (187)**Wire seals (UNIT : mm)**

电线密封栓(毫米)

The wire seals are common to M and F.

电线密封栓为公端、母端共用。

(S)**(7165-0346)**

Cable size (mm ²) 适用电线大小	(AVS/0.3) (AVSS/0.3~0.85) (AVSSX·AESSX/0.5~0.75) (CAVUS/0.85~1.25)
Cable overall diameter(mm) 带绝缘层外径	1.4~2.0
Material 材质	Silicon 硅
Color 颜色	Dark Brown 深棕

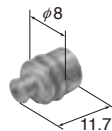
**(M)****(7165-0347)**

Cable size (mm ²) 适用电线大小	(AV/0.5~1.25) (AVX·AEX/0.5~1.25) (AVS/0.5~1.25) (AVSS/1.25~2.0) (AVSSX·AESSX/1.25~2.0)
Cable overall diameter(mm) 带绝缘层外径	2.0~2.9
Material 材质	Silicon 硅
Color 颜色	Dark Green 墨绿

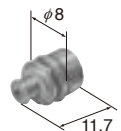
**(L)****(7165-0348)**

Cable size (mm ²) 适用电线大小	(AV/2.0) (AVX·AEX/2.0) (AVS/2.0)
Cable overall diameter(mm) 带绝缘层外径	2.9~3.5
Material 材质	Silicon 硅
Color 颜色	Dark Gray 深灰

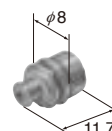
**(LL)****(7165-0356)**

Cable size (mm ²) 适用电线大小	(AV/3.0) (AVX·AEX/3.0) (AVS/3.0)
Cable overall diameter(mm) 带绝缘层外径	3.5~4.1
Material 材质	Silicon 硅
Color 颜色	Dark Blue 藏青

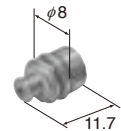

4.8mm (187)

Dummy plugs (UNIT : mm)

盲塞 (毫米)

- Dummy plugs are common to M and F.
- Dummy plugs are used to blind unused terminal holes.
- 盲塞为公端、母端共用。
- 盲塞用于堵塞不使用的端子孔。

(7165-0145)

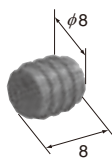

Material 材质	NBR
Color 颜色	Gray 灰

4.8mm (187)

Housing (UNIT : mm)

接插件护套 (毫米)

Ref: Terminal part No. 端子参照页	B-19
Ref: wire seal No. 电线密封栓参照页	B-20
Ref: Dummy plug No. 盲塞参照页	B-21
Material 材质	PBT

1way

Color 颜色	Gray 灰
-------------	-----------

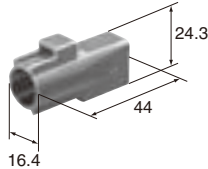

M (6188-0083) F (6189-0145)

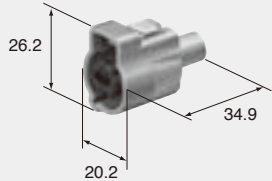

Color 颜色	Gray 灰
-------------	-----------

1way

F (6189-0413)

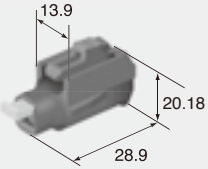

Color 颜色	Black 黑
-------------	------------

2way

Color 颜色	Gray 灰
-------------	-----------

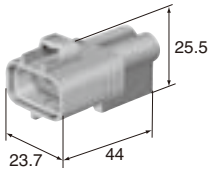

M (6188-0259) F (6189-0425)

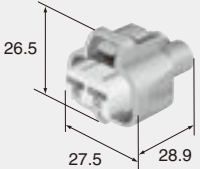

Color 颜色	Gray 灰
-------------	-----------

3way

Color Gray
颜色 灰

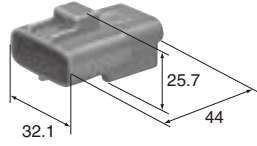

B-22

M (6188-0129)

F (6189-0165)

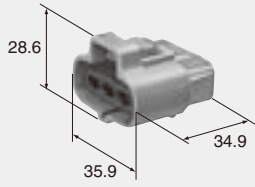

Color Gray
颜色 灰

TS SEALED SERIES for STANDARD

8.0mm (312)

Structure / 构造

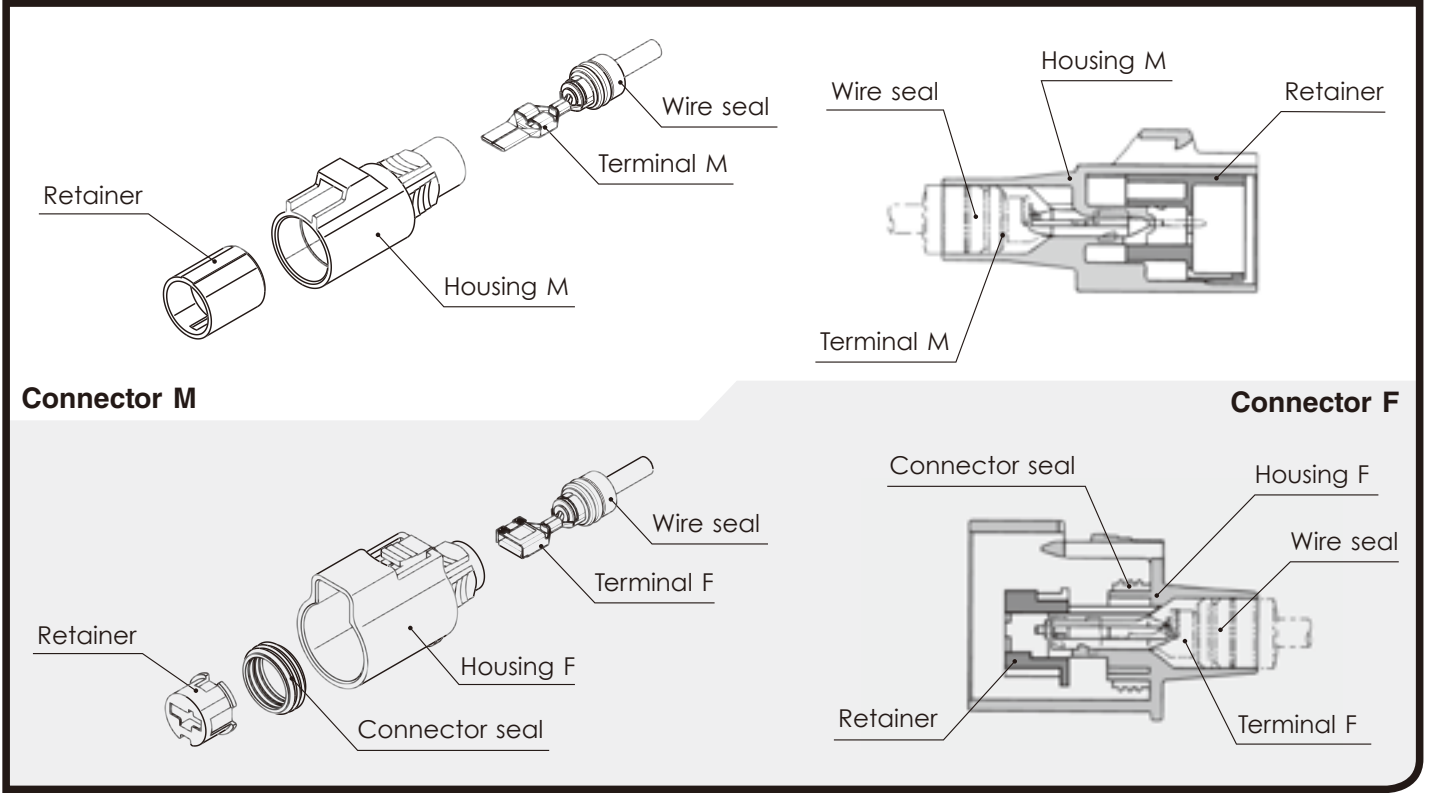

B-23
TS SEALED SERIES

8.0mm (312)

Terminal (UNIT: mm)

端子(毫米)

(S)

Cable size (mm ²) 适用电线大小	0.5~1.25
Cable overall diameter (mm) 带绝缘层外径	2.0~2.7
Material 材质	Brass 黄铜
Surface treatment 表面处理	Tin-plated 镀锡

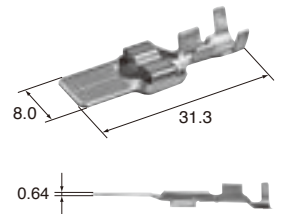

M (8100-0506)

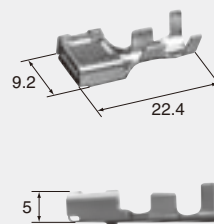

F (8100-0451)

Cable size (mm ²) 适用电线大小	0.5~1.25
Cable overall diameter (mm) 带绝缘层外径	2.0~2.7
Material 材质	Brass 黄铜
Surface treatment 表面处理	Tin-plated 镀锡

(M)Cable size (mm²) 2.0~3.0

适用电线大小

Cable overall diameter (mm) 2.6~4.1

带绝缘层外径

Material Brass

材质 黄铜

Surface treatment Tin-plated

表面处理 镀锡

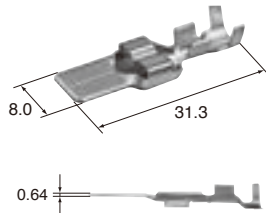
**(L)**Cable size (mm²) 5.0~8.0

适用电线大小

Cable overall diameter (mm) 4.4~5.8

带绝缘层外径

Material Brass

材质 黄铜

Surface treatment Tin-plated

表面处理 镀锡

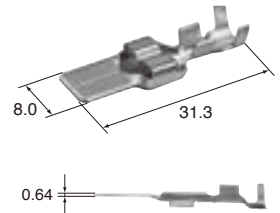

B-24

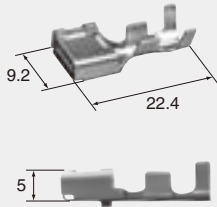
M (8100-0507)**F (8100-0452)**Cable size (mm²) 2.0~3.0

适用电线大小

Cable overall diameter (mm) 2.6~4.1

带绝缘层外径

Material Brass

材质 黄铜

Surface treatment Tin-plated

表面处理 镀锡

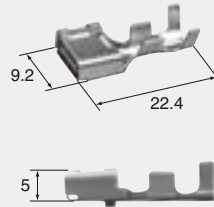
M (8100-0508)**F (8100-2980)**Cable size (mm²) 5.0~8.0

适用电线大小

Cable overall diameter (mm) 4.4~5.8

带绝缘层外径

Material Heat-resistant copper alloy

材质 耐热铜合金

Surface treatment Tin-plated

表面处理 镀锡

8.0mm (312)**Wire seals (UNIT : mm)**

电线密封栓(毫米)

The wire seals are common to M and F.

电线密封栓为公端、母端共用。

(SS)**(7165-0683)**Cable size (mm²) (AVS·AVX/0.5~1.25)

适用电线大小

Cable overall diameter (mm) Over 2.0 mm less than 2.9 mm

带绝缘层外径

Material Silicon

材质 硅

Color Dark Brown

颜色 深棕

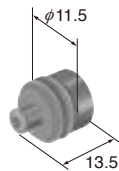
**(S)****(7165-0400)**Cable size (mm²) (AV/3.0) (AVX·AEX/3.0) (AVS/3.0)

适用电线大小

Cable overall diameter (mm) 3.6~4.1

带绝缘层外径

Material Silicon

材质 硅

Color Dark Gray

颜色 深灰

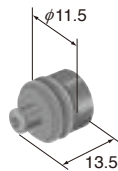
**(M)****(7165-0392)**Cable size (mm²) (AV/5.0) (AVX·AEX/5.0) (AVS/5.0)

适用电线大小

Cable overall diameter (mm) 4.4~4.9

带绝缘层外径

Material Silicon

材质 硅

Color Dark Blue

颜色 藏青

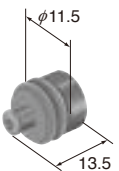
**(L)****(7165-0393)**Cable size (mm²) (AV/8.0) (AVX·AEX/8.0) (AVS/8.0)

适用电线大小

Cable overall diameter (mm) 5.3~5.8

带绝缘层外径

Material Silicon

材质 硅

Color Black

颜色 黑

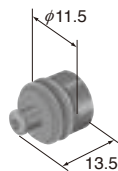

8.0mm (312)

Dummy plugs (UNIT : mm)

盲塞 (毫米)

- Dummy plugs are common to M and F.
- Dummy plugs are used to blind unused terminal holes.
- 盲塞为公端、母端共用。
- 盲塞用于堵塞不使用的端子孔。

(7165-0180)

Material 材质	NBR
Color 颜色	Gray 灰

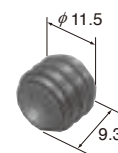

8.0mm (312)

Housing (UNIT : mm)

接插件护套 (毫米)

Ref: Terminal part No. 端子参照页	B-23
---------------------------------	------

Ref: wire seal No. 电线密封栓参照页	B-24
--------------------------------	------

Ref: Dummy plug No. 盲塞参照页	B-25
------------------------------	------

Material 材质	PBT
----------------	-----

1way

Color 颜色	Gray 灰
-------------	-----------

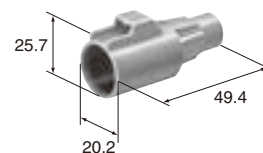

M (6188-0049)

F (6189-0101)

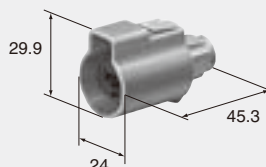

Color 颜色	Gray 灰
-------------	-----------

2way

Color 颜色	Gray 灰
-------------	-----------

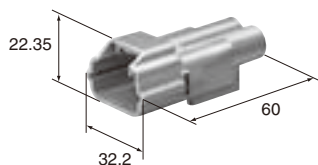

M (6188-0096)

F (6189-0172)

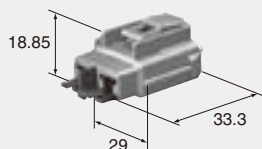

Color 颜色	Gray 灰
-------------	-----------

2way

F (6189-0856)

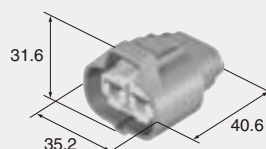

Color 颜色	Gray 灰
-------------	-----------

2way

F (6189-6953)

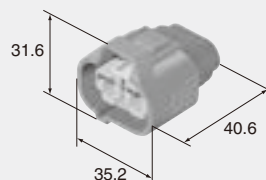

Color 颜色	Gray 灰
-------------	-----------

2way

Color Gray
颜色 灰

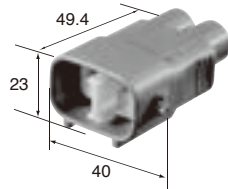

M (6188-5295)

F (6189-7256)

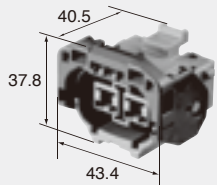

Color Gray
颜色 灰

0.64mm, 2.3mm (025, 090)

Housing (UNIT : mm)

接插件护套(毫米)

Ref: Terminal part No. 端子参照页	[0.64mm] [2.3mm]	B-03 B-13
Ref: wire seal No. 电线密封栓参照页	[0.64mm] [2.3mm]	B-04 B-14
Ref: Dummy plug No. 盲塞参照页	[0.64mm] [2.3mm]	B-04 B-15

Material
材质 PBT

No. of way/ () corresponds to 0.64mm, 2.3mm, in order from left to right.
极数 / () 内显示: 从左向右为0.64mm 极数、2.3mm 极数

TS SEALED SERIES for HYBRID

10way (6+4)

F (6189-7691)

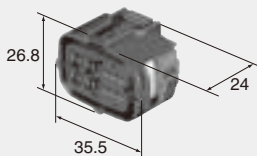

Color Black
颜色 黑

13way (10+3)

F (6189-7077)

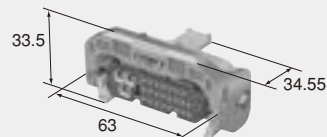

Color Gray
颜色 灰

26way (23+3)

F (6189-6934)

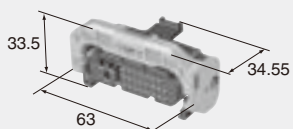

Color Black
颜色 黑

0.64mm, 4.8mm
(025, 187)

Housing (UNIT : mm)

接插件护套(毫米)

Ref: Terminal part No. [0.64mm] B-03
端子参照页 [4.8mm] B-19

Ref: wire seal No. [0.64mm] B-04
电线密封栓参照页 [4.8mm] B-20

Ref: Dummy plug No. [0.64mm] B-04
盲塞参照页 [4.8mm] B-21

Material PBT
材质

No. of way () corresponds to 0.64mm, 4.8mm, in order from left to right.
极数 / () 内显示 : 从左向右为0.64mm 极数、4.8mm 极数

4way (2+2)

Color Black
颜色 黑

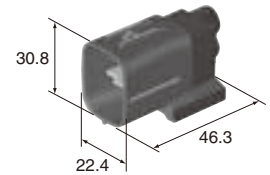

M (6188-5103)

F (6189-1048)

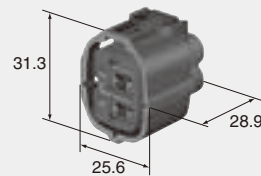

Color Black
颜色 黑

24way (22+2)

F (6189-7426)

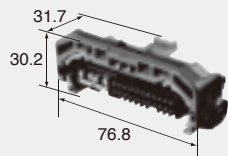

Color Gray
颜色 灰

34way (30+4)

F (6189-6978)

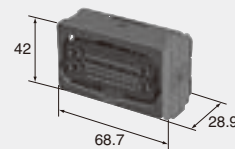

Color Black
颜色 黑

34way (30+4)

F (6189-6979)

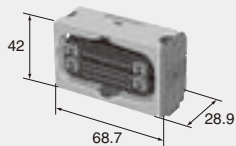

Color Gray
颜色 灰

34way (30+4)

F (6189-6980)

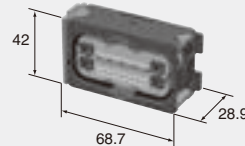

Color Black
颜色 黑

34way (30+4)

F (6189-6981)

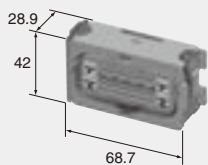

Color Gray
颜色 灰

40way (36+4)

F (6189-1160)

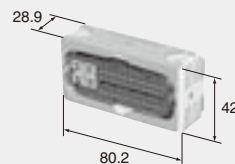

Color Gray
颜色 灰

46way (42+4)

F (6189-1136)

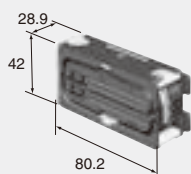

Color Black
颜色 黑

46way (42+4)

F (6189-6894)

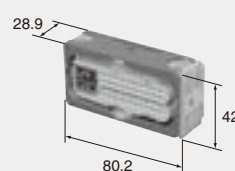

Color Black
颜色 黑

0.64mm, 2.3mm, 4.8mm (025, 090, 187)

Housing (UNIT : mm)

接插件护套(毫米)

Ref: Terminal part No. 端子参照页	[0.64mm]	B-03
	[2.3mm]	B-13
	[4.8mm]	B-19
Ref: wire seal No. 电线密封栓参照页	[0.64mm]	B-04
	[2.3mm]	B-14
	[4.8mm]	B-20
Ref: Dummy plug No. 盲塞参照页	[0.64mm]	B-04
	[2.3mm]	B-15
	[4.8mm]	B-21

Material
材质 PBT

No. of way/ () corresponds to 0.64mm, 2.3mm, 4.8mm in order from left to right.
极数 / () 内显示 : 从左向右为0.64mm 极数、2.3mm 极数、4.8mm 极数

B-28

42way (36+2+4)

F (6189-7094)

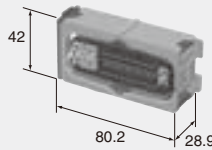

Color
颜色 Black
黑

52way (42+4+6)

F (6189-7809)

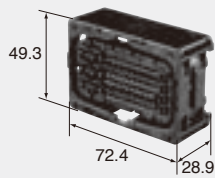

Color
颜色 Black
黑

Lever Assy

(6911-5948)

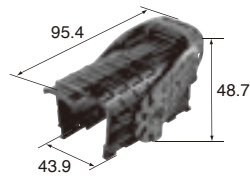

Color
颜色 Black
黑

2.3mm, 4.8mm (090, 187)

Housing (UNIT : mm)

接插件护套(毫米)

Ref: Terminal part No. 端子参照页	[2.3mm] B-13 [4.8mm] B-19
Ref: wire seal No. 电线密封栓参照页	[2.3mm] B-14 (For P6) [4.8mm] B-20
Ref: Dummy plug No. 盲塞参照页	[2.3mm] B-15 (For P6) [4.8mm] B-21

Material
材质 PBT

No. of way/ () corresponds to 2.3mm, 4.8mm in order from left to right.
极数/ () 内显示: 从左向右为2.3mm 极数、4.8mm 极数

4way (2+2)

Color Gray
颜色 灰

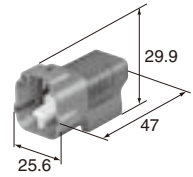

M (6188-0415)

F (6189-0144)

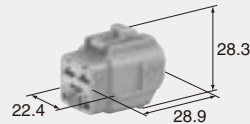

Color Gray
颜色 灰

5way (3+2)

Color Gray
颜色 灰

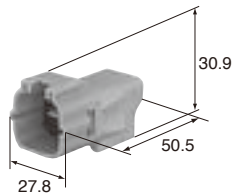

M (6188-0091)

F (6189-0166)

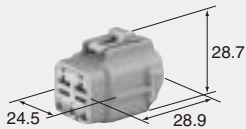

Color Gray
颜色 灰

5way (3+2)

Color Gray
颜色 灰

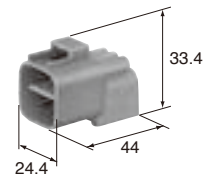

M (6188-0101)

F (6189-0181)

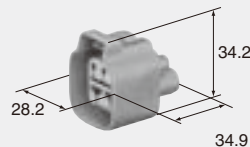

Color Gray
颜色 灰

6way (4+2)

Color Gray
颜色 灰

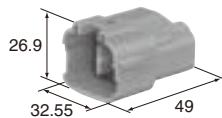

M (6188-0187)

F (6189-0143)

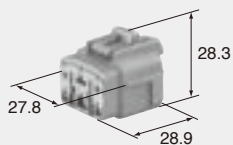

Color Gray
颜色 灰

11way (8+3)

Color Gray
颜色 灰

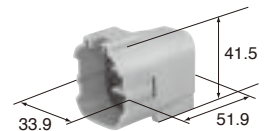

M (6188-0221)

F (6189-0376)

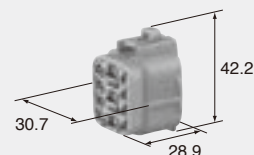

Color Gray
颜色 灰

4.8mm, 8.0mm
(187, 312)

Housing (UNIT : mm)

接插件护套(毫米)

Ref: Terminal part No. [4.8mm] B-19
端子参照页 [8.0mm] B-23

Ref: wire seal No. [4.8mm] B-20
电线密封栓参照页 [8.0mm] B-24

Ref: Dummy plug No. [4.8mm] B-21
盲塞参照页 [8.0mm] B-25

Material
材质 PBT

No. of way/ () corresponds to 4.8mm, 8.0mm in order from left to right.
极数 / () 内显示 : 从左向右为4.8mm 极数、8.0mm 极数

3way (1+2)

F (6189-7156)

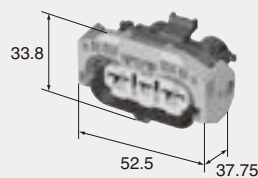

Color
颜色 Black
黑

HE SERIES



Features

The HE connector series is the highly reliable improved version of the conventional HD series, with a mechanism that minimizes the possibility of terminal back out and semi-engagement of connectors.

This series consists of 0.64mm, 1.0mm, 2.3mm, 4.8mm and 9.5mm types (0.64mm, 1.0mm, 2.3mm, 4.8mm and 8.0mm types for the hybrid model) classified according to terminal size, supporting use in a variety of control circuits and low power circuits.

- An incompletely inserted terminal is automatically adjusted to the correct position by setting a retainer.
- Retainers are pre-mounted on the connector housing, and are structured to enable setting by the same simple operation regardless of the number of ways, improving operability.
- An extra clip can be attached to the connector housing to secure it to the car body, and multiple connectors can be joined.
- PCB models are also available for connection to printed circuit boards.
- RoHS/ELV Compliant

特点

HE 系列是将以往的 HD 系列改良后，提高了可靠性的接插件。

具有不易发生端子脱落及接插件半嵌合的构造。按照端子尺寸划分为 0.64mm · 1.0mm · 2.3mm · 4.8mm · 9.5mm (混合型为 0.64mm · 1.0mm · 2.3mm · 4.8mm · 8.0mm)，可以应用于各种控制回路与低功率。

- 未完全插入的端子能够通过安装锁片插入到正确的位置。
- 锁片预先组装在接插件护套上，无论多少极数都能通过简单操作组合，有助于提高操作效率。
- 在接插件护套上可安装卡钉（卡子）用以固定在车体上，并且可以将各个接插件相互连接。
- 我们还设计了能适用于印刷电路板的 PCB 接插件。
- 可对应欧盟 RoHS 和 ELV 指令

HE SERIES for STANDARD

0.64mm (025)

Structure / 构造

C-02

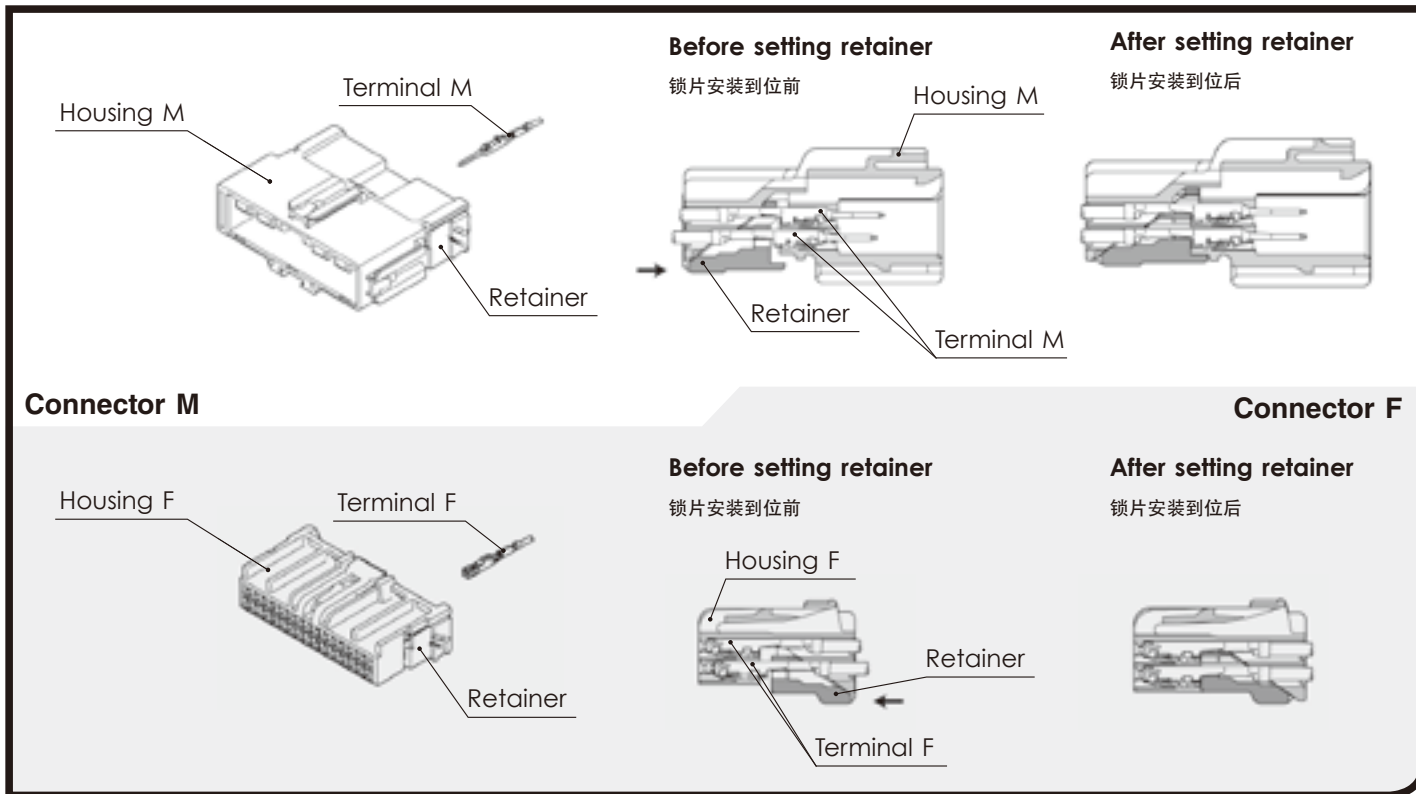

0.64mm (025)

Terminal (UNIT : mm)

端子(毫米)

(S)Cable size (mm²) 0.22~0.35

适用电线大小

Cable overall diameter(mm) 0.95~1.4

带绝缘层外径

Material Brass

材质 黄铜

Surface treatment Tin-plated

表面处理 镀锡

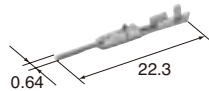
**(M)**Cable size (mm²) 0.5~0.75

适用电线大小

Cable overall diameter(mm) 1.25~1.6

带绝缘层外径

Material Brass

材质 黄铜

Surface treatment Tin-plated

表面处理 镀锡

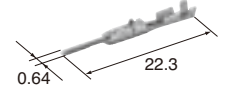
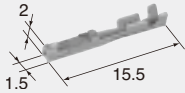
**M (8100-4028)****F (8100-4029)**Cable size (mm²) 0.22~0.35

适用电线大小

Cable overall diameter(mm) 0.95~1.4

带绝缘层外径

Material Heat-resistant copper alloy

材质

Surface treatment Tin-plated

表面处理 镀锡

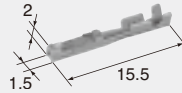
M (8100-4027)**F (8100-4030)**Cable size (mm²) 0.5~0.75

适用电线大小

Cable overall diameter(mm) 1.25~1.6

带绝缘层外径

Material Heat-resistant copper alloy

材质

Surface treatment Tin-plated

表面处理 镀锡

0.64mm (025)**Housing** (UNIT : mm)

Ref: Terminal part No.

端子参照页

C-02

Material

材质

PBT

2way

Color

颜色

Natural

自然色

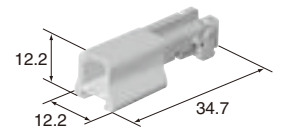
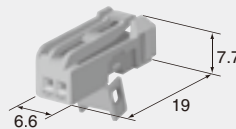
**M (6098-5070)****F (6098-5071)**

Color

颜色

Natural

自然色

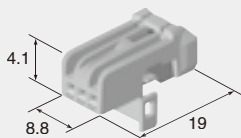
3way**F (6098-5833)**

Color

颜色

Natural

自然色

4way

Color

颜色

Natural

自然色

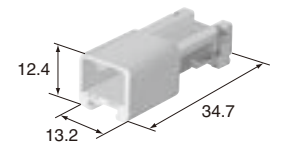
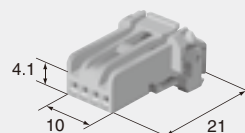
**M (6098-4944)****F (6098-4978)**

Color

颜色

Natural

自然色

6way

Color 颜色 Natural 自然色

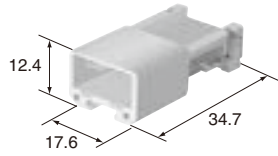

7way

F (6098-5000)

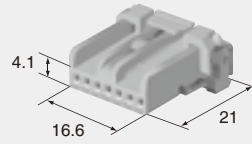

Color 颜色 Natural 自然色

C-04

M (6098-4943)

F (6098-4979)

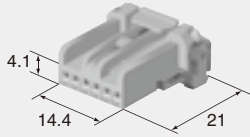

Color 颜色 Natural 自然色

10way

F (6098-4982)

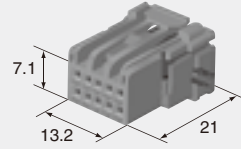

Color 颜色 Green 绿

12way

Color 颜色 Natural 自然色

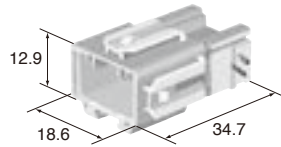

M (6098-4675)

F (6098-4640)

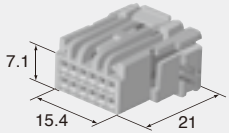

Color 颜色 Natural 自然色

16way

Color 颜色 Natural 自然色

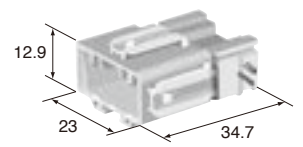

M (6098-4333)

F (6098-4339)

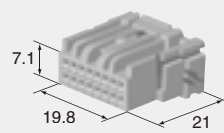

Color 颜色 Natural 自然色

20way

Color 颜色 Natural 自然色



M (6098-4589)

F (6098-4595)



Color 颜色 Natural 自然色

24way

Color 颜色 Natural 自然色



M (6098-4588)

F (6098-4594)

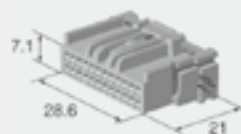

Color 颜色 Natural 自然色

34way

Color Natural
颜色 自然色



M (6098-4590)

F (6098-4596)



Color Natural
颜色 自然色

HE SERIES for STANDARD

1.0mm (040)

Structure / 构造

C-06

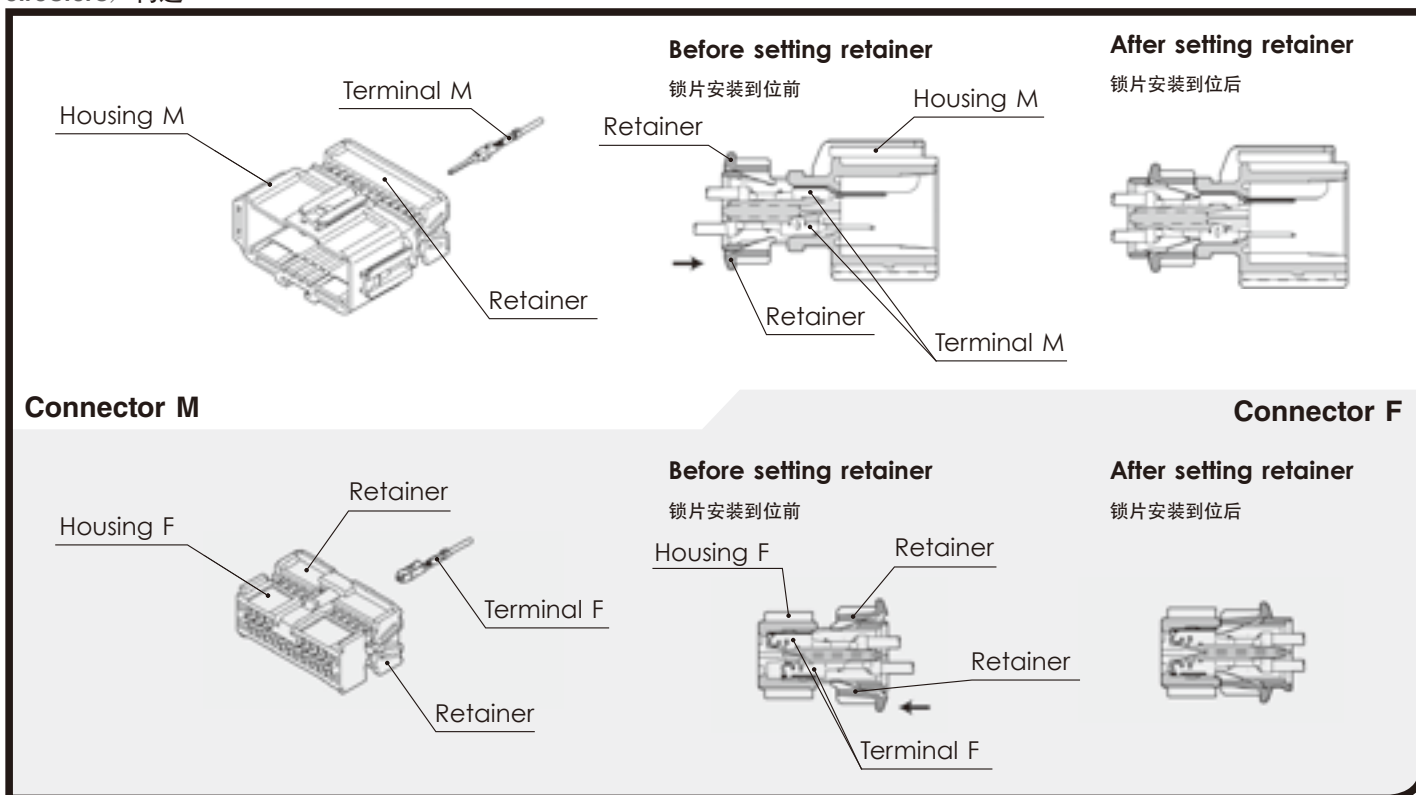

1.0mm (040)

Terminal (UNIT : mm)

端子(毫米)

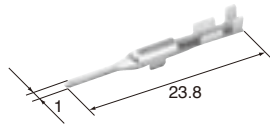
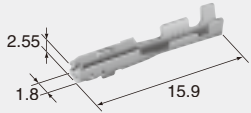
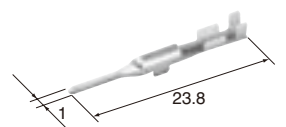
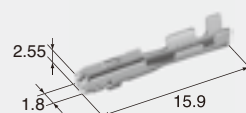
(SS)Cable size (mm²) 0.22~0.35
适用电线大小Cable overall diameter(mm) 0.95~1.1
带绝缘层外径Material Brass
材质 黄铜Surface treatment Tin-plated
表面处理 镀锡**M (8100-4307)****F (8100-4308)**Cable size (mm²) 0.22~0.35
适用电线大小Cable overall diameter(mm) 0.95~1.1
带绝缘层外径Material Heat-resistant copper alloy
材质Surface treatment Tin-plated
表面处理 镀锡**(S)**Cable size (mm²) 0.3~0.85
适用电线大小Cable overall diameter(mm) 1.4~1.8
带绝缘层外径Material Brass
材质 黄铜Surface treatment Tin-plated
表面处理 镀锡**M (8100-2972)****F (8100-2971)**Cable size (mm²) 0.3~0.85
适用电线大小Cable overall diameter(mm) 1.4~1.8
带绝缘层外径Material Heat-resistant copper alloy
材质Surface treatment Tin-plated
表面处理 镀锡**1.0mm (040)****Housing** (UNIT : mm)

接插件护套(毫米)

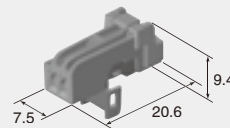
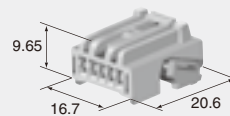
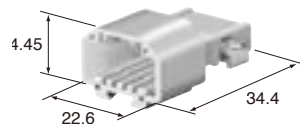
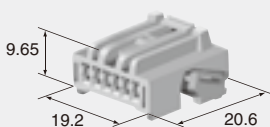
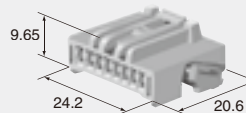
Ref: Terminal part No. C-06
端子参照页Material PBT
材质**2way****F (6098-5888)**Color Light Gray
颜色 浅灰**5way****F (6098-2779)**Color Natural
颜色 自然色**6way**Color Natural
颜色 自然色**M (6098-2780)****F (6098-2781)**Color Natural
颜色 自然色**8way****F (6098-2782)**Color Natural
颜色 自然色

C-07

HE SERIES

13way

Color Natural
颜色 自然色

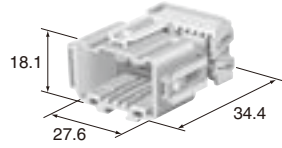

17way

Color Natural
颜色 自然色

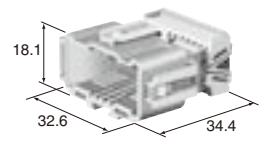

C-08

M (6098-2788)

F (6098-2784)

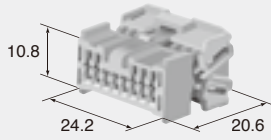

Color Natural
颜色 自然色

M (6098-3369)

F (6098-2785)

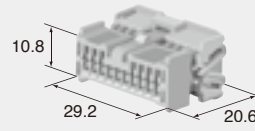

Color Natural
颜色 自然色

21way

Color Natural
颜色 自然色

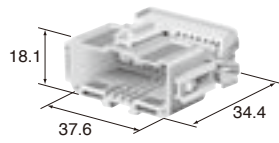

M (6098-2789)

F (6098-2764)

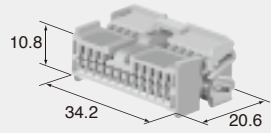

Color Natural
颜色 自然色

HE SERIES for STANDARD

2.3mm (090)

Structure / 构造

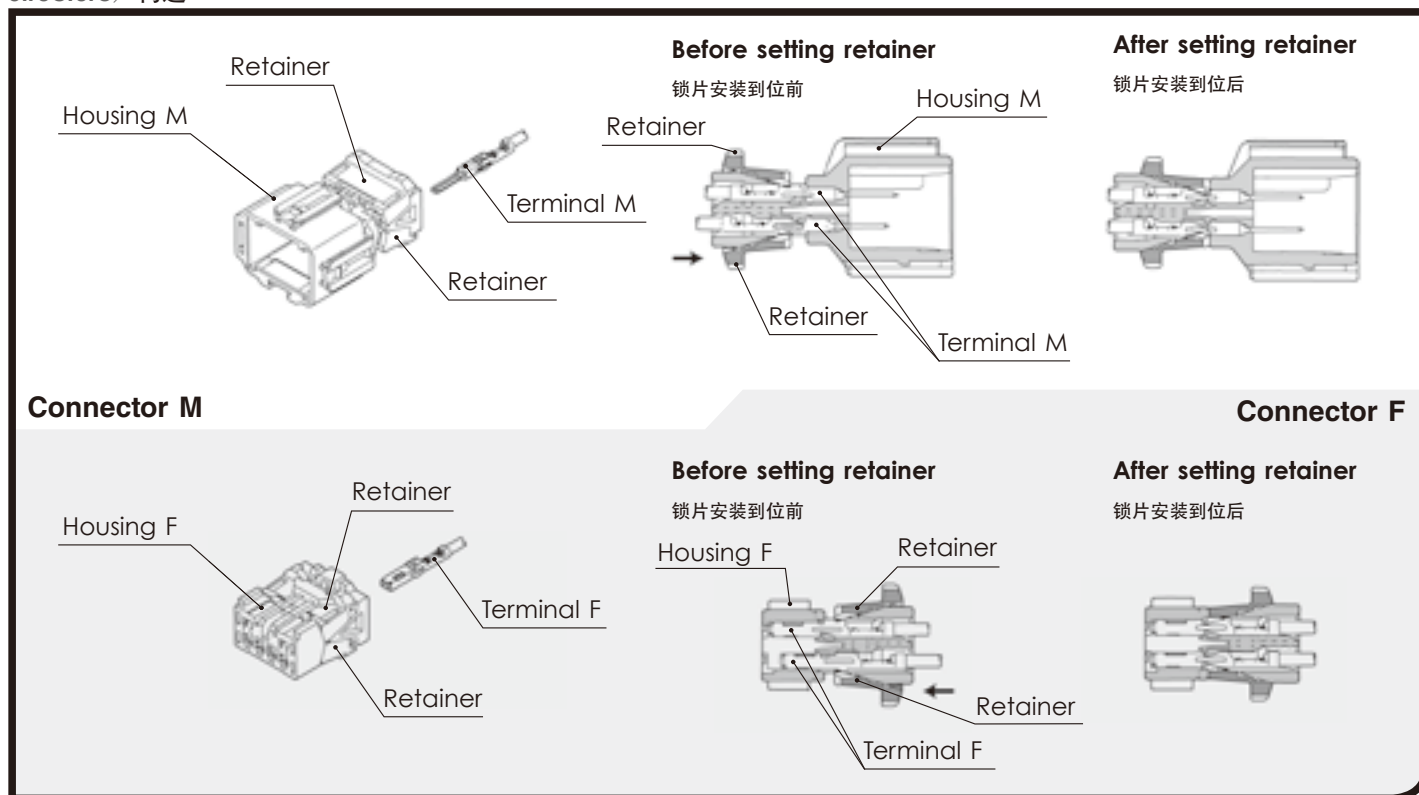

C-09

HE SERIES

2.3mm (090)

Terminal (UNIT: mm)

端子(毫米)

(S)

Cable size (mm ²) 适用电线大小	0.3~0.5
Cable overall diameter (mm) 带绝缘层外径	1.4~2.1
Material 材质	Brass 黄铜
Surface treatment 表面处理	Tin-plated 镀锡

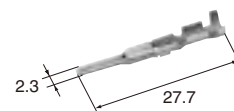

M (8100-1571)

F (8100-1470)

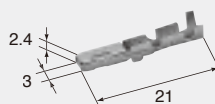

Cable size (mm ²) 适用电线大小	0.3~0.5
Cable overall diameter (mm) 带绝缘层外径	1.4~2.1
Material 材质	Brass 黄铜
Surface treatment 表面处理	Tin-plated 镀锡

(M)

Cable size (mm ²) 适用电线大小	0.5~1.25
---	----------

Cable overall diameter(mm) 带绝缘层外径	2.0~2.9
--------------------------------------	---------

Material 材质	Brass 黄铜
----------------	-------------

Surface treatment 表面处理	Tin-plated 镀锡
---------------------------	------------------

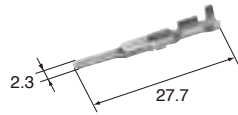
**(L)**

Cable size (mm ²) 适用电线大小	2.0
---	-----

Cable overall diameter(mm) 带绝缘层外径	2.6~3.1
--------------------------------------	---------

Material 材质	Brass 黄铜
----------------	-------------

Surface treatment 表面处理	Tin-plated 镀锡
---------------------------	------------------

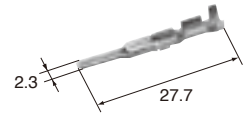
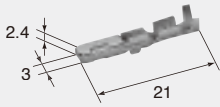
**C-10****M (8100-1573)****F (8100-1472)**

Cable size (mm ²) 适用电线大小	0.5~1.25
---	----------

Cable overall diameter(mm) 带绝缘层外径	2.0~2.9
--------------------------------------	---------

Material 材质	Brass 黄铜
----------------	-------------

Surface treatment 表面处理	Tin-plated 镀锡
---------------------------	------------------

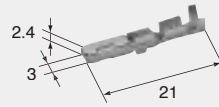
M (8100-1572)**F (8100-1471)**

Cable size (mm ²) 适用电线大小	2.0
---	-----

Cable overall diameter(mm) 带绝缘层外径	2.6~3.1
--------------------------------------	---------

Material 材质	Heat-resistant copper alloy
----------------	--------------------------------

Surface treatment 表面处理	Tin-plated 镀锡
---------------------------	------------------

2.3mm (090)**Housing** (UNIT : mm)

接插件护套(毫米)

Ref: Terminal part No. 端子参照页	C-09
---------------------------------	------

Material 材质	PBT
----------------	-----

2way

Color 颜色	Natural 自然色
-------------	----------------

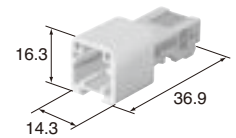
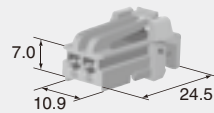
**M (6098-4901)****F (6098-4069)**

Color 颜色	Natural 自然色
-------------	----------------

3way

Color 颜色	Natural 自然色
-------------	----------------

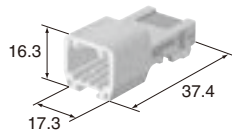
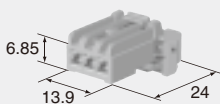
**M (6098-5049)****F (6098-4071)**

Color 颜色	Natural 自然色
-------------	----------------

4way

Color 颜色	Natural 自然色
-------------	----------------

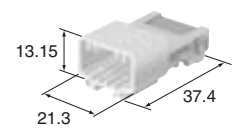
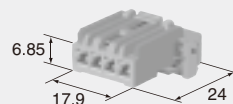
**M (6098-4902)****F (6098-4073)**

Color 颜色	Natural 自然色
-------------	----------------

6way

Color 颜色 Sky Blue 天蓝

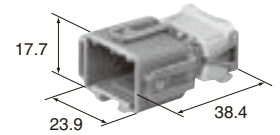

M (6098-1373)

F (6098-1377)

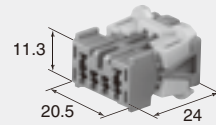

Color 颜色 Sky Blue 天蓝

5way

Color 颜色 Natural 自然色



M (6098-4664)

F (6098-4669)

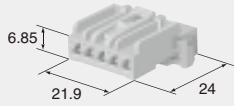

Color 颜色 Natural 自然色

8way

Color 颜色 Natural 自然色

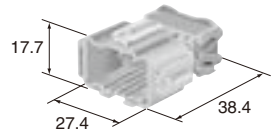

M (6098-4661)

F (6098-4670)

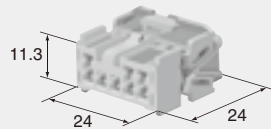

Color 颜色 Natural 自然色

8way

F (6098-1378)

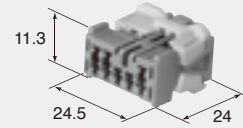

Color 颜色 Green 绿

16way

F (6098-3563)

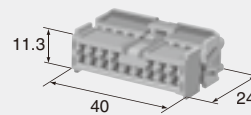

Color 颜色 Natural 自然色

14way

Color 颜色 Natural 自然色

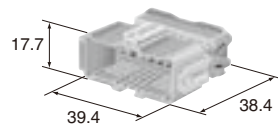

M (6098-4662)

F (6098-4050)

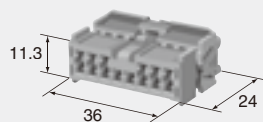

Color 颜色 Natural 自然色

20way

F (6098-1380)

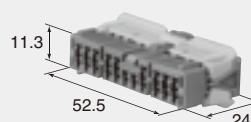

Color 颜色 Green 绿

HE SERIES for STANDARD

4.8mm (187)

C-12

4.8mm (187)

Terminal (UNIT : mm)

端子(毫米)

(M)

Cable size (mm ²) 适用电线大小	0.5~1.25
Cable overall diameter (mm) 带绝缘层外径	1.6~2.9
Material 材质	Brass 黄铜
Surface treatment 表面处理	Tin-plated 镀锡

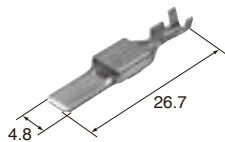

M (8100-0664)

F (8100-0606)

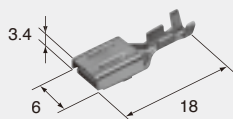

Cable size (mm ²) 适用电线大小	0.5~1.25
Cable overall diameter (mm) 带绝缘层外径	1.6~2.9
Material 材质	Heat-resistant copper alloy
Surface treatment 表面处理	Tin-plated 镀锡

(S)

Cable size (mm ²) 适用电线大小	0.3
Cable overall diameter (mm) 带绝缘层外径	1.4~1.9
Material 材质	Brass 黄铜
Surface treatment 表面处理	Tin-plated 镀锡

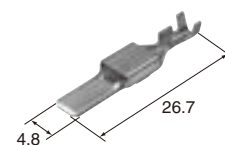

M (8100-1506)

F (8100-1507)

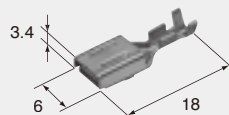

Cable size (mm ²) 适用电线大小	0.3
Cable overall diameter (mm) 带绝缘层外径	1.4~1.9
Material 材质	Heat-resistant copper alloy
Surface treatment 表面处理	Tin-plated 镀锡

(L)

Cable size (mm ²) 适用电线大小	2.0~3.0
Cable overall diameter (mm) 带绝缘层外径	2.6~3.8
Material 材质	Brass 黄铜
Surface treatment 表面处理	Tin-plated 镀锡

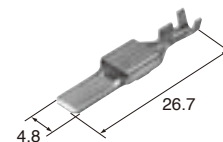

M (1500-0166)

F (8100-0782)

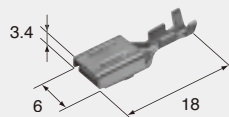

Cable size (mm ²) 适用电线大小	2.0~3.0
Cable overall diameter (mm) 带绝缘层外径	2.6~3.8
Material 材质	Heat-resistant copper alloy
Surface treatment 表面处理	Tin-plated 镀锡

4.8mm (187)

Housing (UNIT : mm)

接插件护套(毫米)

Ref: Terminal part No. C-13
端子参照页

Material PBT
材质

2way

Color Natural
颜色 自然色

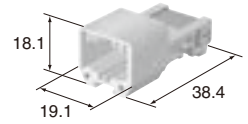

M (6098-5120)

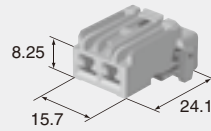

F (6098-5119)

Color Natural
颜色 自然色

4way

F (6098-4971)

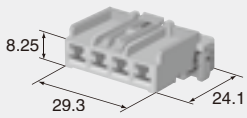

Color Natural
颜色 自然色

5way

Color Natural
颜色 自然色

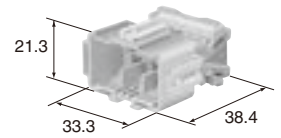

M (6098-4663)

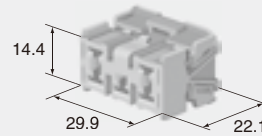

F (6098-4667)

Color Natural
颜色 自然色

C-13

HE SERIES

HE SERIES for STANDARD

9.5mm (375)

C-14

9.5mm (375)

Terminal (UNIT : mm)

端子(毫米)

(S)

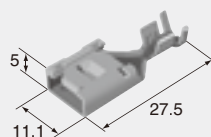

F (8240-0152)

Cable size (mm ²) 适用电线大小	2.0~3.0
Cable overall diameter (mm) 带绝缘层外径	2.6~4.1
Material 材质	Copper alloy 铜合金
Surface treatment 表面处理	Tin-plated 镀锡

(M)



F (8240-0153)

Cable size (mm ²) 适用电线大小	5.0~8.0
Cable overall diameter (mm) 带绝缘层外径	4.4~5.8
Material 材质	Heat-resistant copper alloy
Surface treatment 表面处理	Tin-plated 镀锡

(L)



F (8240-0154)

Cable size (mm ²) 适用电线大小	10.0
Cable overall diameter (mm) 带绝缘层外径	6.5~6.9
Material 材质	Heat-resistant copper alloy
Surface treatment 表面处理	Tin-plated 镀锡

9.5mm (375)

Housing (UNIT : mm)

接插件护套(毫米)

Ref: Terminal part No. C-15
端子参照页

Material PBT
材质

1way

rib A

F (6098-4973)

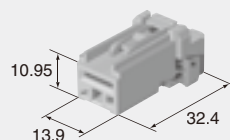

Color Natural
颜色 自然色

1way

rib B

F (6098-4974)

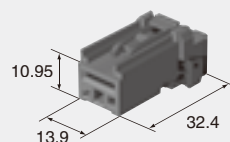

Color Black
颜色 黑

1way **rib C**

F (6098-4975)

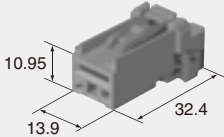

10.95
13.9 32.4

Color Dark Green
颜色 墨绿

2way

F (6098-4977)

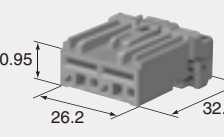

10.95
26.2 32.4

Color Green
颜色 绿

HE SERIES for HYBRID

0.64mm, 2.3mm
(025, 090)

Housing (UNIT : mm)

接插件护套(毫米)

Ref: Terminal part No.	[0.64mm]	C-02
端子参照页	[2.3mm]	C-09

Material	PBT
材质	

No. of way/ () corresponds to 0.64mm, 2.3mm, in order from left to right.
极数 / () 内显示 : 从左向右为0.64mm 极数、2.3mm 极数

12way (6+6)

Color	Natural
颜色	自然色

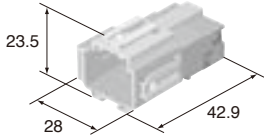

M (6098-6161)

F (6098-6162)

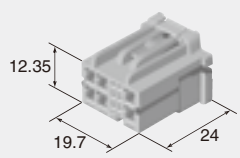

Color	Natural
颜色	自然色

13way (9+4)

Color	Natural
颜色	自然色

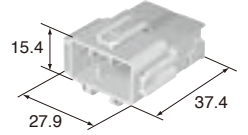

M (6098-5180)

F (6098-6562)

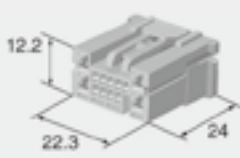

Color	Natural
颜色	自然色

18way (9+9)

Color	Natural
颜色	自然色

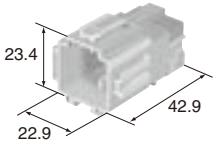

M (6098-4908)

F (6098-6478)

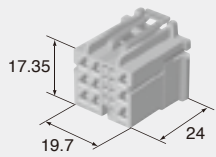

Color	Natural
颜色	自然色

20way (16+4)

Color	Natural
颜色	自然色

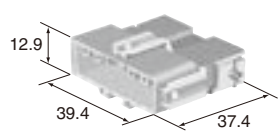

M (6098-4591)

F (6098-4597)

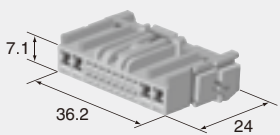

Color	Natural
颜色	自然色

23way (14+9)

Color Natural
颜色 自然色

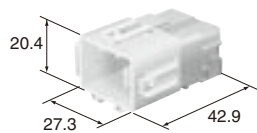

M (6098-4707)

F (6098-6559)

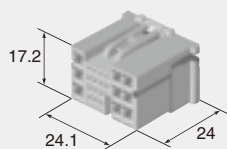

Color Natural
颜色 自然色

28way (24+4)

Color Natural
颜色 自然色

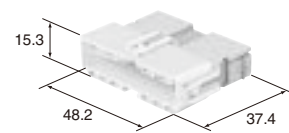

M (6098-4725)

F (6098-4726)

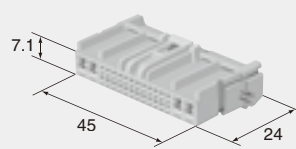

Color Natural
颜色 自然色

C-17

HE SERIES

1.0mm, 2.3mm
(040, 090)

C-18

Housing (UNIT : mm)

接插件护套(毫米)

Ref: Terminal part No. [1.0mm] C-06
端子参照页 [2.3mm] C-09

Material PBT
材质

No. of way/ () corresponds to 1.0mm, 2.3mm, in order from left to right.
极数 / () 内显示: 从左向右为1.0mm 极数、2.3mm 极数

9way (2+7)

F (6098-4075)

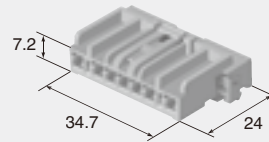

Color Natural
颜色 自然色

10way (2+8)

F (6098-4076)

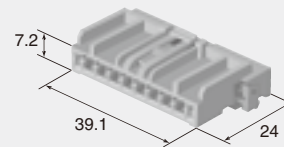

Color Natural
颜色 自然色

10way (6+4)

F (6098-4666)

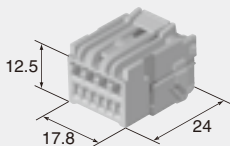

Color Natural
颜色 自然色

10way (8+2)

F (6098-3600)

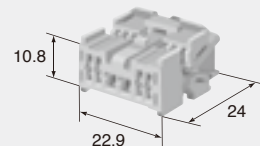

Color Natural
颜色 自然色

14way (10+4)

F (6098-3601)

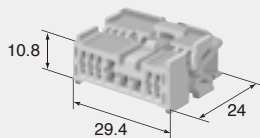

Color Natural
颜色 自然色

23way (19+4)

F (6098-3571)

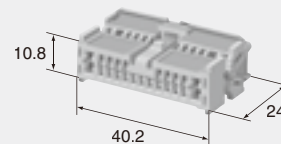

Color Natural
颜色 自然色

23way (19+4)

F (6098-4367)

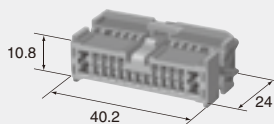

Color Brown
颜色 棕

1.0mm, 4.8mm (040, 187)

Housing (UNIT : mm)

接插件护套(毫米)

Ref: Terminal part No.	[1.0mm]	C-06
端子参照页	[4.8mm]	C-13

Material	PBT
材质	

No. of way/ () corresponds to 1.0mm, 4.8mm, in order from left to right.
极数 / () 内显示 : 从左向右为1.0mm 极数、4.8mm 极数

12way (10+2)

Color	Natural
颜色	自然色

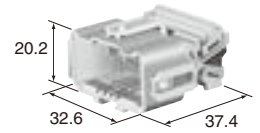

M (6098-3370)

F (6098-2786)

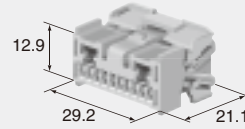

Color	Natural
颜色	自然色

14way (10+4)

F (6098-4017)

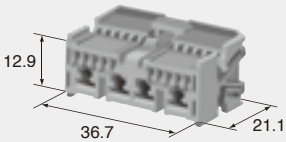

Color	Natural
颜色	自然色

2.3mm, 4.8mm (090, 187)

C-20

Housing (UNIT : mm)

接插件护套(毫米)

Ref: Terminal part No.	[2.3mm]	C-09
端子参照页	[4.8mm]	C-13

Material	PBT
材质	

No. of way/ () corresponds to 2.3mm, 4.8mm, in order from left to right.
极数 / () 内显示: 从左向右为2.3mm 极数、4.8mm 极数

8way (6+2)

Color	Natural
颜色	自然色

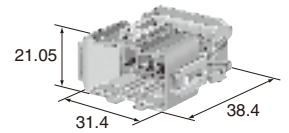

M (6098-5218)

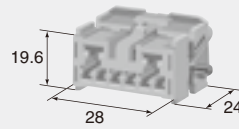

F (6098-5217)

Color	Natural
颜色	自然色

14way (12+2)

Color	Natural
颜色	自然色

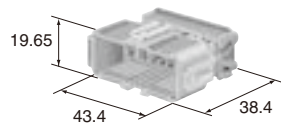

M (6098-4660)

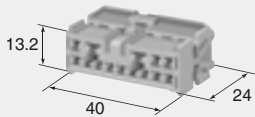

F (6098-3565)

Color	Natural
颜色	自然色

16way (14+2)

F (6950-1054)

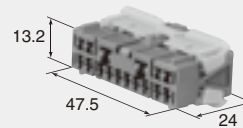

Color	Green
颜色	绿

18way (14+4)

F (6950-1055)

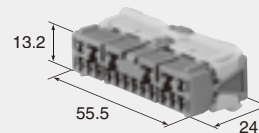

Color	Green
颜色	绿

20way (16+4)

F (6950-1056)

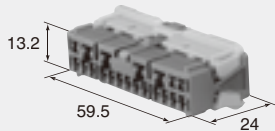

Color	Green
颜色	绿

8.0mm (312)

Terminal (UNIT : mm)

端子 (毫米)

(S)

Cable size (mm ²) 适用电线大小	0.5~1.25
Cable overall diameter (mm) 带绝缘层外径	1.6~2.9
Material 材质	Brass 黄铜
Surface treatment 表面处理	Tin-plated 镀锡

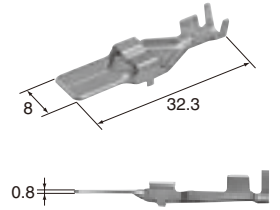

M (8100-0520)

F (8100-0707)

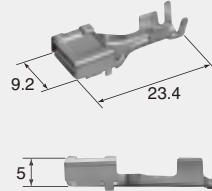

Cable size (mm ²) 适用电线大小	0.5~1.25
Cable overall diameter (mm) 带绝缘层外径	1.6~2.9
Material 材质	Brass 黄铜
Surface treatment 表面处理	Tin-plated 镀锡

(M)

Cable size (mm ²) 适用电线大小	2.0~3.0
Cable overall diameter (mm) 带绝缘层外径	2.6~4.1
Material 材质	Brass 黄铜
Surface treatment 表面处理	Tin-plated 镀锡

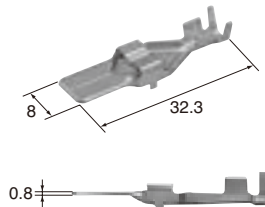

M (8100-0521)

F (8100-0706)

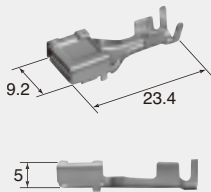

Cable size (mm ²) 适用电线大小	2.0~3.0
Cable overall diameter (mm) 带绝缘层外径	2.6~4.1
Material 材质	Brass 黄铜
Surface treatment 表面处理	Tin-plated 镀锡

(L)

Cable size (mm ²) 适用电线大小	5.0~8.0
Cable overall diameter (mm) 带绝缘层外径	4.4~5.8
Material 材质	Brass 黄铜
Surface treatment 表面处理	Tin-plated 镀锡

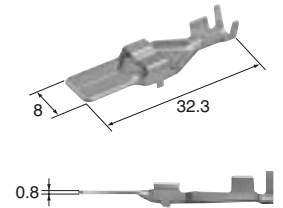

M (8100-0522)

F (8100-1553)

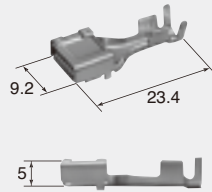

Cable size (mm ²) 适用电线大小	5.0~8.0
Cable overall diameter (mm) 带绝缘层外径	4.4~5.8
Material 材质	Heat-resistant copper alloy
Surface treatment 表面处理	Tin-plated 镀锡

4.8mm, 8.0mm (187, 312)

Housing (UNIT : mm)

接插件护套 (毫米)

Ref: Terminal part No. 端子参照页	[4.8mm] C-13 [8.0mm] C-21
---------------------------------	------------------------------

Material 材质	PBT
----------------	-----

No. of way/ () corresponds to 4.8mm, 8.0mm, in order from left to right.
极数 / () 内显示: 从左向右为4.8mm 极数、8.0mm 极数

6way (4+2)

Color 颜色	Natural 自然色
-------------	----------------

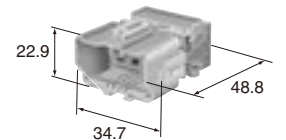

M (6098-3567)

F (6098-3569)

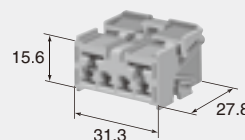

Color 颜色	Natural 自然色
-------------	----------------

HE SERIES COMMON USE PARTS

Body fastening clamp (mm)

The clamp can be installed to connector M, if necessary, to fasten into the body side hole.
公端接插件在需要时可以安装卡钉用以固定在车体上。

(6810-1203)

Clamp fitting hole size(mm) 适合孔穴尺寸	φ 7
Clamp fitting thickness(mm) 卡钉适合板厚	t=0.65~1.6
Material 材质	6 Nylon
Color 颜色	Red 红

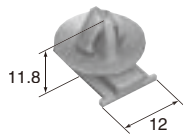

(6810-1217)

Clamp fitting hole size(mm) 适合孔穴尺寸	φ 7
Clamp fitting thickness(mm) 卡钉适合板厚	t=1.6~2.6
Material 材质	6 Nylon
Color 颜色	Brown 棕

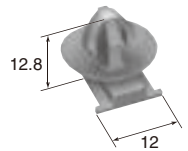

(6810-1204)

Clamp fitting hole size(mm) 适合孔穴尺寸	φ 10
Clamp fitting thickness(mm) 卡钉适合板厚	t=0.65~1.6
Material 材质	6 Nylon
Color 颜色	Natural 自然色

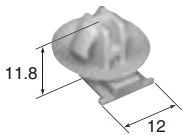

(6810-1462)

Clamp fitting hole size(mm) 适合孔穴尺寸	6×12 (Square hole)
Clamp fitting thickness(mm) 卡钉适合板厚	t=0.65~1.6
Material 材质	6 Nylon
Color 颜色	Orange 橙

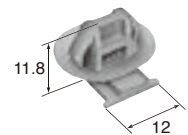

(6910-0119)

Bracket direction 插入支架的方向	Connector mating direction 接插件嵌合方向
Material 材质	6 Nylon
Color 颜色	Red 红

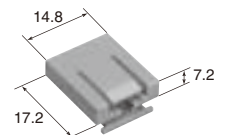

Body fastening clamp (Bracket type) (mm)

Connector M can be accoupled with clamp, if necessary, to fasten to the body side bracket.
公端接插件在需要时可以安装卡钉用以固定在车体上。

(6910-0120)

Bracket direction 插入支架的方向	Anti clock wise 接插件嵌合的反方向
Material 材质	6 Nylon
Color 颜色	Natural 自然色

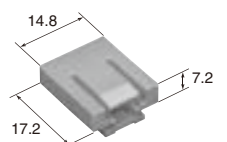

HV/HVG SEALED SERIES

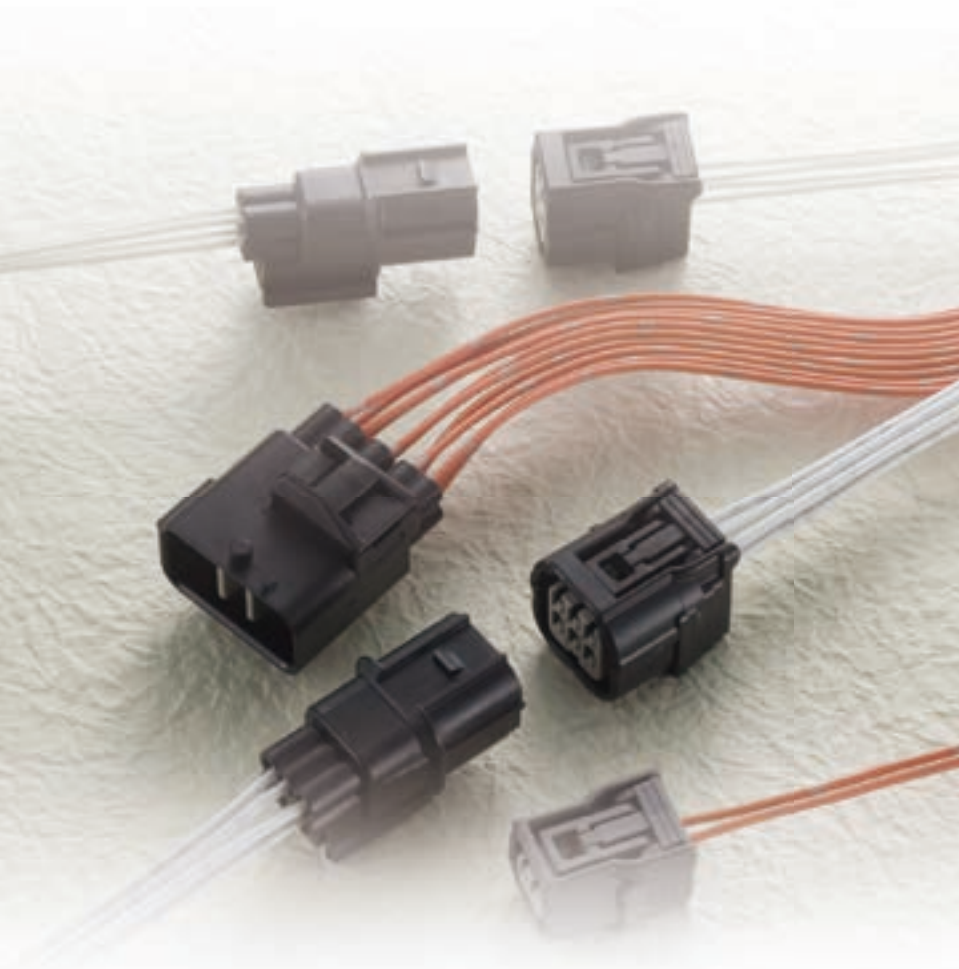

Features

The HV sealed connector series is an improved version of the existing HX sealed connector series and it is a highly reliable connector series.

Also the HVG sealed series is what is added a finger holding portion to the side wall of the female connector of the HV sealed series so as to improving mating performance. It has a mechanism that detects terminal incomplete insertion.

- The connector mechanism only allows the retainer to be set when the terminal is completely inserted.
- These connectors can be directly secured to a bracket on the car body.
- RoHS/ELV Compliant

特点

HV 防水系列是将以往的HX 防水系列改良后，提高了可信性的接插件系列。

此外，HVG 防水系列在HV 防水系列的母端接插件的侧壁上还增加了指扣，提高了接插件插入作业的操作性。

具备检测端子插入不到位的构造。

- 具有当端子在半插入状态时，锁片无法组装到位的检知构造。
- 接插件可以直接固定在车体支架上。
- 可对应欧盟 RoHS 和 ELV 指令

HV/HVG SEALED SERIES for STANDARD

1.0mm (040)

Structure / 构造

D-02

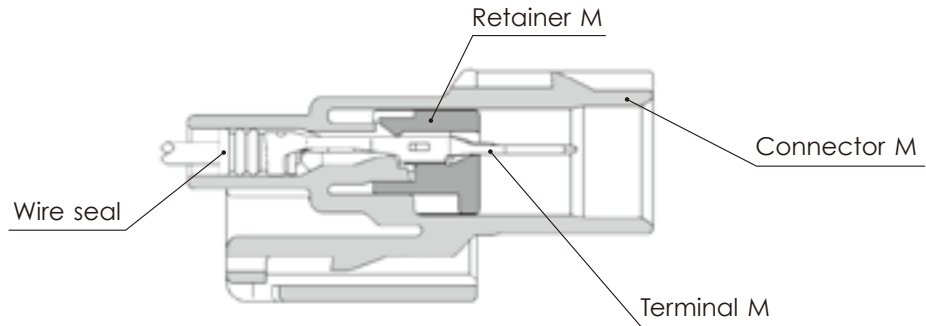

Connector M

Connector F

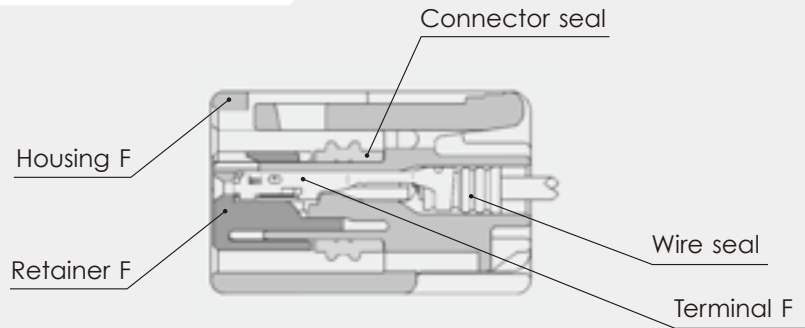

1.0mm (040)

Terminal (UNIT : mm)

端子 (毫米)

Ref; 1.0mm Terminal detail
1.0mm端子参照页

S	M (8100-3177)	E-02	F (8100-3067)	E-02
M	M (8100-3178)	E-02	F (8100-3068)	E-02

1.0mm (040)

Wire seals (UNIT : mm)

电线密封栓 (毫米)

Ref; 1.0mm Wire Seals detail
1.0mm电线密封栓参照页

SS (7165-1075)	E-03
S (7165-0621)	E-03
M (7165-0622)	E-03

The wire seals are common to M and F.
电线密封栓为公端、母端共用。

1.0mm (040)

Dummy plugs (UNIT : mm)

盲塞 (毫米)

Ref; 1.0mm Dummy plug detail

1.0mm盲塞参照页

(7165-0432) E-04

- Dummy plugs are common to M and F.
- Dummy plugs are used to blind unused terminal holes.
- 盲塞为公端、母端共用。
- 盲塞用于堵塞不使用的端子孔。

1.0mm (040)

Housing (UNIT : mm)

接插件护套 (毫米)

Ref: Terminal part No. E-02
端子参照页

Ref: wire seal No. E-03
电线密封栓参照页

Ref: Dummy plug No. E-04
盲塞参照页

Material PBT
材质

3way

Color Black
颜色 黑

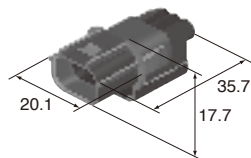

M (6188-4775)

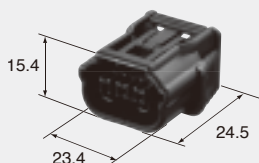

NOTE1)

Color Black
颜色

F (6189-7037)

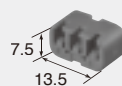

Retainer No. (6918-1833)

Color Black
颜色

2way

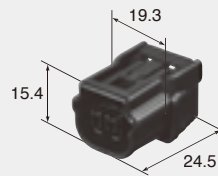

F (6189-7036)

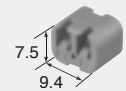

Retainer No. (6918-1835)

Color Black
颜色

Color Black
颜色

2way

(Rib difference) (Rib差异)

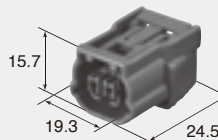

F (6189-7052)

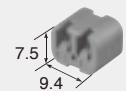

Retainer No. (6918-1835)

Color Dark Gray
颜色

Color Dark Gray
颜色

3way

(Rib difference) (Rib差异)

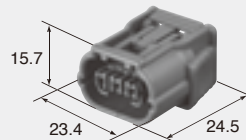

F (6189-7058)



Retainer No. (6918-1833)

Color Dark Gray
颜色

Color Dark Gray
颜色

D-04

4way

Color Black
颜色 黑

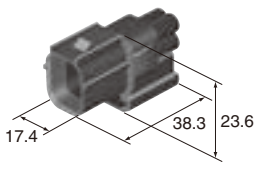

M (6188-4776) **F (6189-7039)**

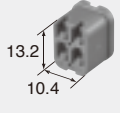
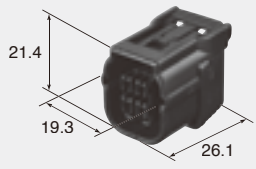

NOTE1) Retainer No. (6918-2810)
Color Black
颜色 黑

6way

Color Black
颜色 黑

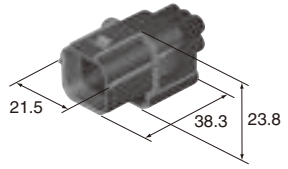

M (6188-4908) **F (6189-7040)**

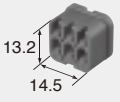
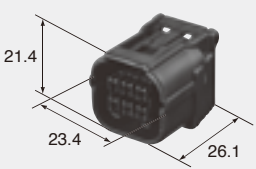

NOTE1) Retainer No. (6918-2913)
Color Black
颜色 黑

NOTE1) HV SEALED SERIES

5way

F (6189-6909)

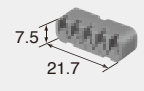
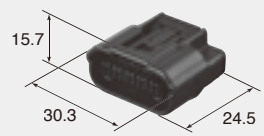

NOTE1) Retainer No. (6918-2128)
Color Black
颜色 黑

10way

Color Black
颜色 黑

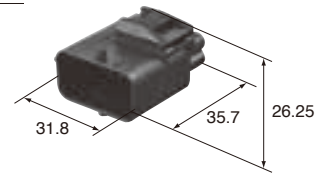
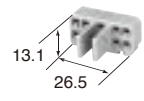

Retainer No. (6918-2804)

M (6181-6481) **F (6189-6906)**

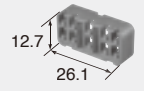
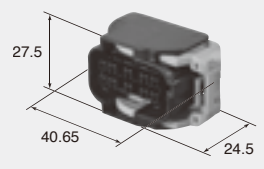

Retainer No. (6918-2806)
Color Black
颜色 黑

HX SEALED SERIES

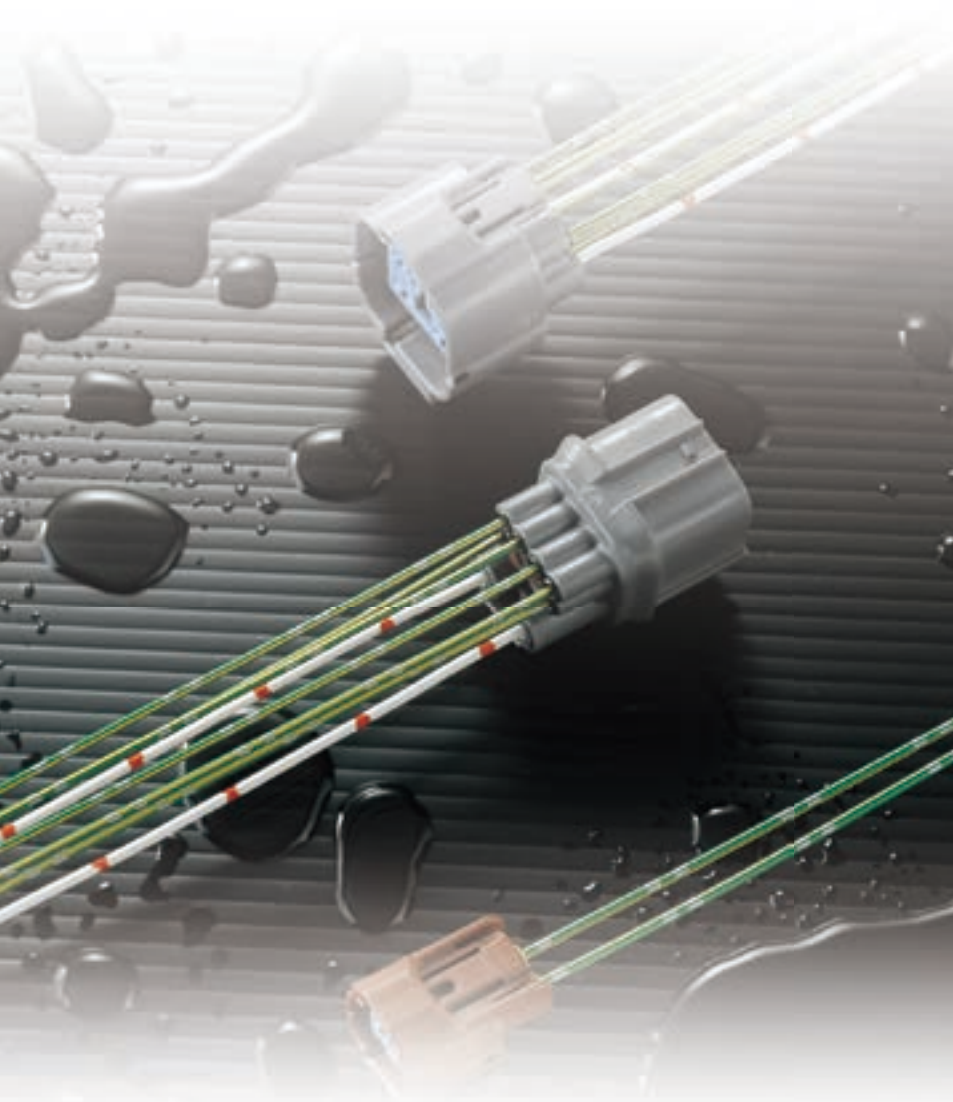

Features

The HX sealed connector series is the highly reliable improved version of the conventional HW sealed series, with a mechanism that detects when terminals are not inserted completely.

This series consists of 1.0mm · 1.5mm · 2.3mm types (0.64mm · 1.0mm · 1.5mm · 2.3mm · 4.8mm types for the hybrid model) classified according to terminal size, supporting use in a variety of control circuits and low power circuits.

- The connector mechanism only allows the retainer to be set when the terminal is completely inserted.
- The hybrid model can be directly secured to a bracket on the car body, but this is only possible when the locking mechanism ensures the connectors are completely engaged, preventing semi-engagement.
- RoHS/ELV Compliant

特点

HX 系列是将以往的 HW 系列改良后、提高了可信性的接插件。

具有检测端子插入不足的结构。

按照端子尺寸划分为 1.0mm · 1.5mm · 2.3mm (混合为 0.64mm · 1.0mm · 1.5mm · 2.3mm · 4.8mm)，可以应用于各种控制回路与低功率回路。

- 拥有当端子在半插入状态时，锁片无法组装到位的检知构造。
- 混合型的接插件具有在未完全嵌合的状态下，无法固定到车体支架上的锁定构造。
- 混合型的接插件可以直接固定在车体的支架上。
- 可对应欧盟 RoHS 和 ELV 指令

HX SEALED SERIES for STANDARD

1.0mm (040)

Structure / 构造

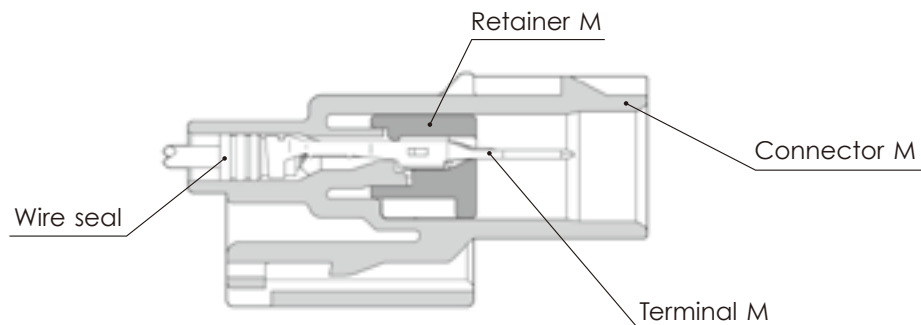

Connector M

Connector F

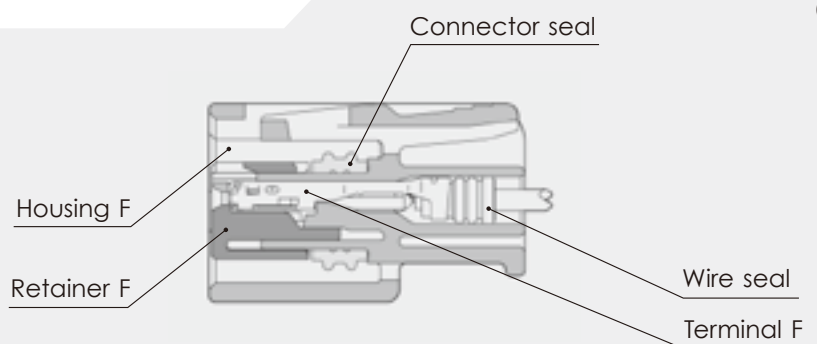

1.0mm (040)

Terminal (UNIT : mm)

端子(毫米)

(S)

Cable size (mm²) 适用电线大小	0.3~0.5
Cable overall diameter(mm) 带绝缘层外径	1.4~2.0
Material 材质	Brass 黄铜
Surface treatment 表面处理	Tin-plated 镀锡

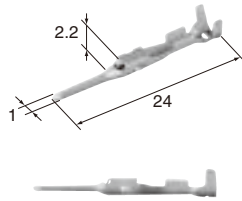
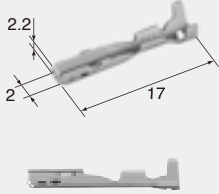
**M (8100-3177)**

Cable size (mm²) 适用电线大小	0.3~0.5
Cable overall diameter(mm) 带绝缘层外径	1.4~2.0
Material 材质	Heat-resistant copper alloy
Surface treatment 表面处理	Tin-plated 镀锡

F (8100-3067)**(M)**

Cable size (mm²) 适用电线大小	0.75~1.25
Cable overall diameter(mm) 带绝缘层外径	1.8~2.2
Material 材质	Heat-resistant copper alloy
Surface treatment 表面处理	Tin-plated 镀锡

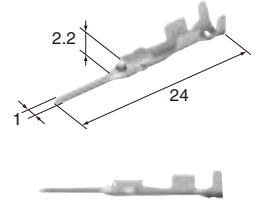
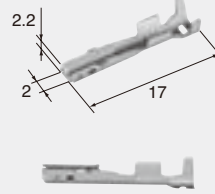
**M (8100-3178)**

Cable size (mm²) 适用电线大小	0.75~1.25
Cable overall diameter(mm) 带绝缘层外径	1.8~2.2
Material 材质	Heat-resistant copper alloy
Surface treatment 表面处理	Tin-plated 镀锡

F (8100-3068)**1.0mm (040)****Wire seals (UNIT : mm)**

电线密封栓(毫米)

The wire seals are common to M and F.

电线密封栓为公端、母端共用。

(SS)

Cable size (mm²) 适用电线大小	(AVSS/0.3) (AVSSX/0.3) (AVSSH/0.3) (CHFUS/0.35) (CHFS/0.5)
Cable overall diameter(mm) 带绝缘层外径	1.1~1.6
Material 材质	Silicon 硅
Color 颜色	Orange 橙

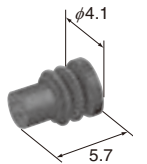
(7165-1075)**(S)**

Cable size (mm²) 适用电线大小	(AVS/0.3) (AVSS/0.5) (AVSSX/0.5) (AVSSH/0.5) (CHFS/0.75)
Cable overall diameter(mm) 带绝缘层外径	1.6~1.9
Material 材质	Silicon 硅
Color 颜色	Light Green 淡绿

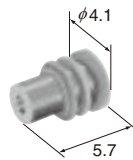
(7165-0621)**(M)**

Cable size (mm²) 适用电线大小	(AVS/0.5) (AVS/0.85) (AVSS/0.75~1.25) (AVSSX/0.75~1.25) (AVSSH/0.75~1.25) (AVX/0.5) (AVX/0.75) (CHFS/1.0)
Cable overall diameter(mm) 带绝缘层外径	1.8~2.2
Material 材质	Silicon 硅
Color 颜色	Violet 紫

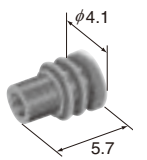
(7165-0622)

1.0mm (040)

Dummy plugs (UNIT : mm)

盲塞 (毫米)

- Dummy plugs are common to M and F.
- Dummy plugs are used to blind unused terminal holes.
- 盲塞为公端、母端共用。
- 盲塞用于堵塞不使用的端子孔。

E-04

1.0mm (040)

Housing (UNIT : mm)

接插件护套 (毫米)

Ref: Terminal part No. E-02
端子参照页

Ref: wire seal No. E-03
电线密封栓参照页

Ref: Dummy plug No. E-04
盲塞参照页

Material PBT
材质

(7165-0432)



Material 材质	NBR
Color 颜色	Black 黑

1way

Color 颜色	Black 黑
-------------	------------

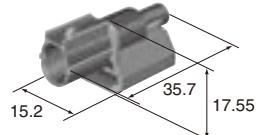

M (6188-0657)	F (6189-0940)
----------------------	----------------------

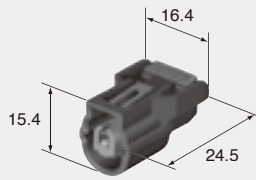
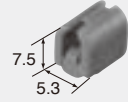



Retainer No. (6918-1979)

Color 颜色	Black 黑
-------------	------------

2way

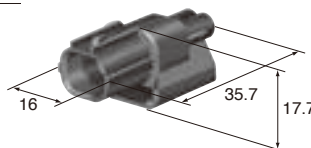
Color 颜色	Black 黑
-------------	------------



M (6188-0589)	F (6189-0890)
----------------------	----------------------

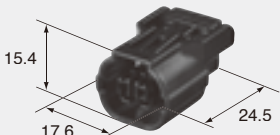
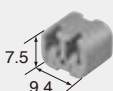



Retainer No. (6918-1835)

Color 颜色	Black 黑
-------------	------------

2way (Rib difference) (Rib差异)

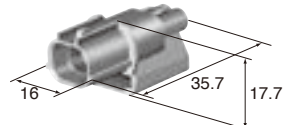
Color 颜色	Dark Gray 深灰
-------------	-----------------

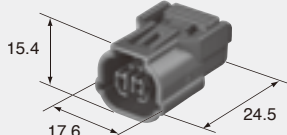
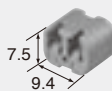

M (6188-0590)	F (6189-0891)
----------------------	----------------------

Retainer No. (6918-1835)

Color 颜色	Dark Gray 深灰
-------------	-----------------

3way

Color 颜色
Black 黑



M (6188-4739)



Color 颜色
Black 黑

F (6189-0887)

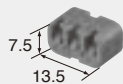

Retainer No. (6918-1833)

3way (Rib difference) (Rib差异)

F (6189-0968)

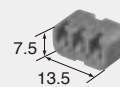
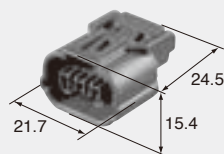

Retainer No. (6918-1833)

Color 颜色
Black 黑

5way

F (6189-1081)

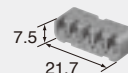

Retainer No. (6918-2128)

Color 颜色
Black 黑

6way

Color 颜色
Black 黑

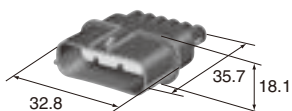

M (6188-0658)

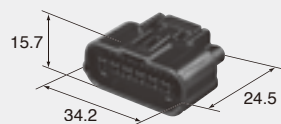

Color 颜色
Black 黑

F (6189-1012)

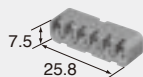

Retainer No. (6918-2056)

7way

F (6189-0855)

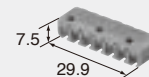

Retainer No. (6918-1762)

Color 颜色
Black 黑

HX SEALED SERIES for 23way and 33way

1.0mm (040)

Structure / 构造

E-06

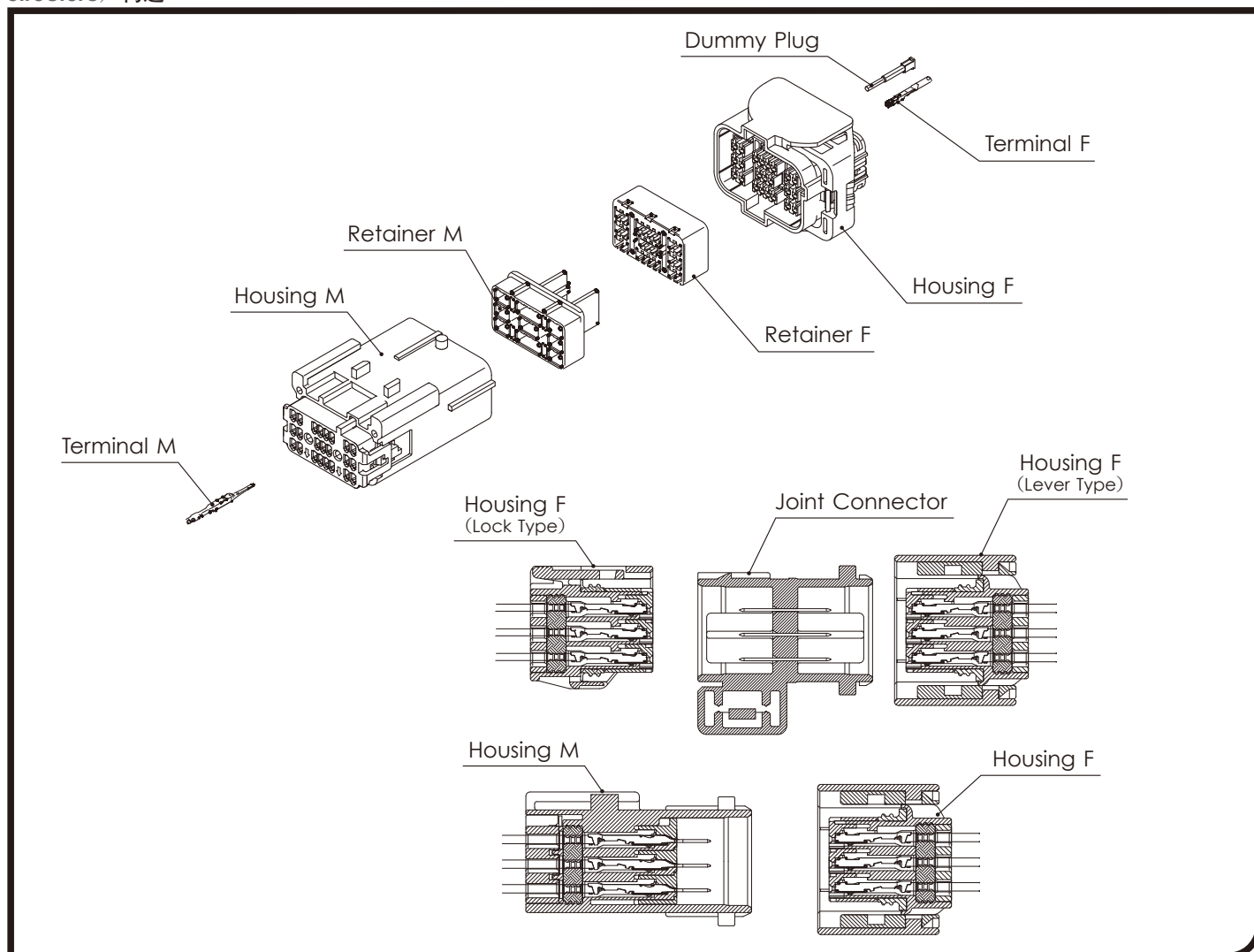

1.0mm (040)

Terminal (UNIT : mm)

端子(毫米)

(S)

Cable size (mm²) 适用电线大小	0.3~0.5
Material 材质	Brass 黄铜
Surface treatment 表面处理	Tin-plated 镀锡

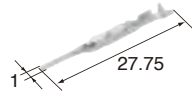
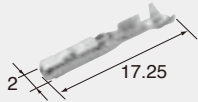
**M (8100-3508)****F (8100-3082)**

Cable size (mm²) 适用电线大小	0.3~0.5
Material 材质	Heat-resistant copper alloy
Surface treatment 表面处理	Tin-plated 镀锡

(M)

Cable size (mm²) 适用电线大小	0.75~1.25
Material 材质	Heat-resistant copper alloy
Surface treatment 表面处理	Tin-plated 镀锡

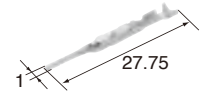
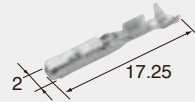
**M (8100-3507)****F (8100-3083)**

Cable size (mm²) 适用电线大小	0.75~1.25
Material 材质	Heat-resistant copper alloy
Surface treatment 表面处理	Tin-plated 镀锡

1.0mm (040)**Dummy plugs (UNIT : mm)**

盲塞 (毫米)

- Dummy plugs are common to M and F.
- Dummy plugs are used to blind unused terminal holes.
- 盲塞为公端、母端共用。
- 盲塞用于堵塞不使用的端子孔。

1.0mm (040)**Housing (UNIT : mm)**

接插件护套 (毫米)

Ref: Terminal part No. 端子参照页	E-07
Ref: Dummy plug No. 盲塞参照页	E-07
Material 材质	PBT

(6914-0050)

Material 材质	PP
Color 颜色	Brown 棕

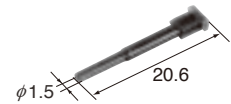
**23way**

Color 颜色	Black 黑
--------------------	------------

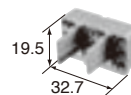

Retainer No. (6918-2131)

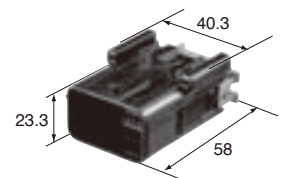
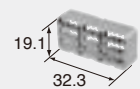
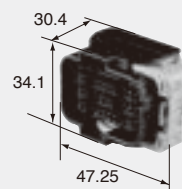
**M (6188-0660)****F (6189-1082)**

Retainer No. (6918-2132)

Color 颜色	Black 黑
--------------------	------------

23way

Joint Connector

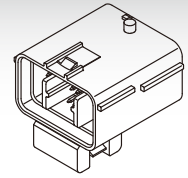

Coupling circuit is connected with busbers as shown gray hatched cavities.

M (6188-4787)

Color
颜色 Black
黑

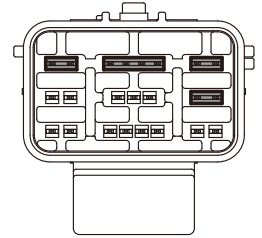
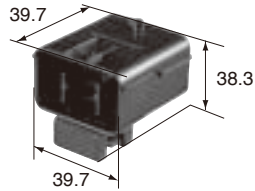

M (6188-4789)

Color
颜色 Dark Gray
深灰

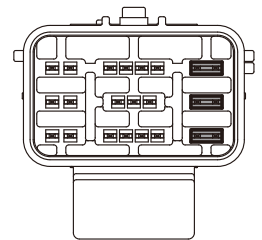
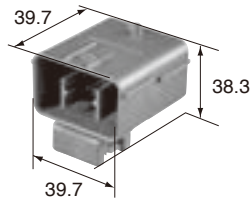

M (5010-8627)

Color
颜色 Dark Blue
藏青

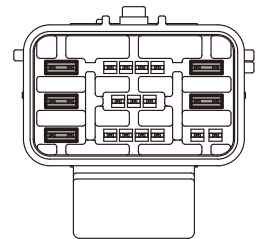
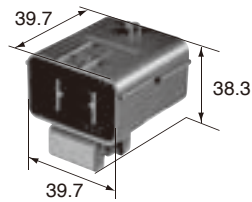

M (5011-1590)

Color
颜色 Brown
棕

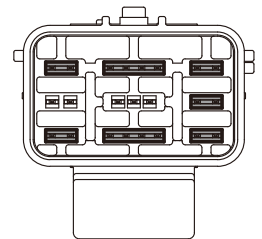
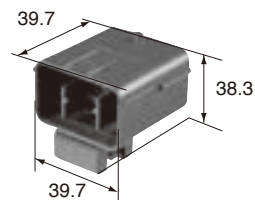

M (5011-6687)

Color
颜色 Blue
蓝

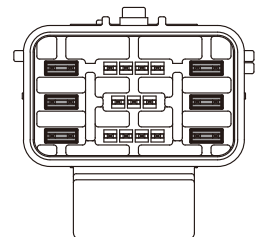
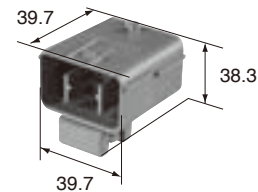

F (6189-1082)

Lever

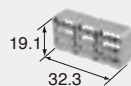
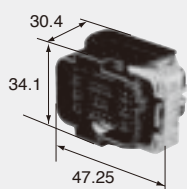

Retainer No. (6918-2132)

Color
颜色 Black
黑

Lock

F (6189-6914)

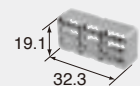
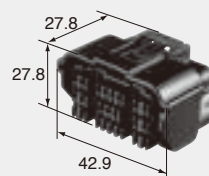

Retainer No. (6918-2132)

Color
颜色 Black
黑

33way

Color 颜色 Black 黑

Retainer No. (6918-2103)

M (6188-0697) **F (6189-1050)**

Retainer No. (6918-2104)

Color 颜色 Black 黑

33way (Rib difference) (Rib差异)

Color 颜色 Dark Gray 深灰

Retainer No. (6918-2103)

M (6188-0698) **F (6189-1051)**

Retainer No. (6918-2104)

Color 颜色 Dark Gray 深灰

Bracket Holder

(6920-0886)

Color 颜色 Black 黑

Bracket Holder

(6920-0861)

Color 颜色 Black 黑

Bracket Holder

(6920-2376)

Color 颜色 Dark Blue 藏青

Bracket Holder

(6920-2377)

Color 颜色 Black 黑

Bracket Holder

(6920-0884)

Color 颜色 Black 黑

Bracket Holder

(6920-2466)

Color 颜色 Black 黑

HX SEALED SERIES 22way Joint Connector

HYBRID 0.64mm, 1.0mm (025, 040)

Structure / 构造

E-10

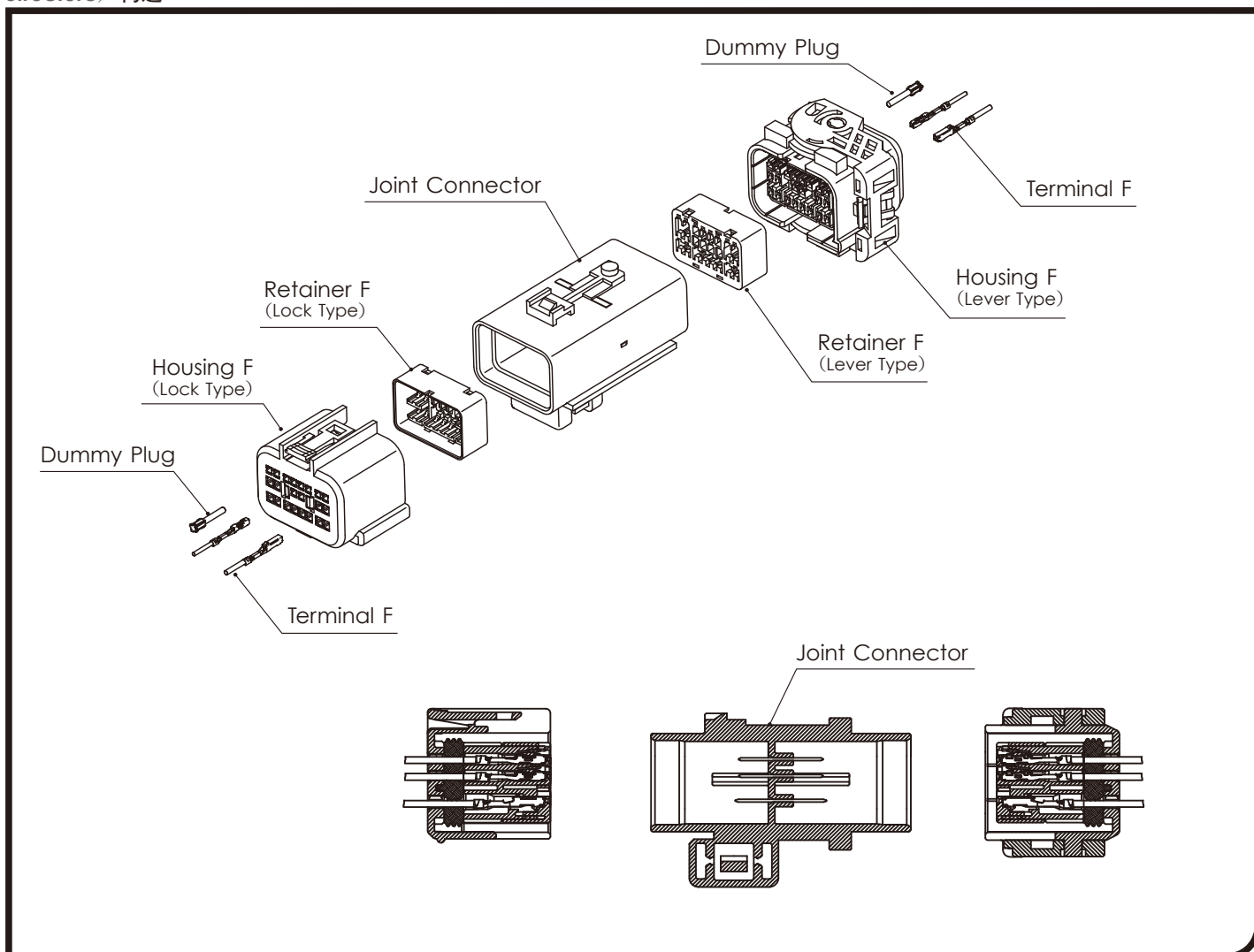

0.64mm (025)

Terminal (UNIT: mm)

端子(毫米)

(SS)

F (8240-0408)

Cable size (mm²) AVSSH0.22

Material Heat-resistant copper alloy

Surface treatment Tin-plated

表面处理 镀锡

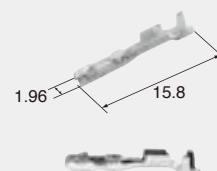

(S)**F (8240-0409)**

Cable size (mm²) 适用电线大小	AVSSH0.3~0.5
Material 材质	Heat-resistant copper alloy
Surface treatment 表面处理	Tin-plated 镀锡

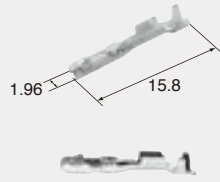
**(M)****F (8240-0410)**

Cable size (mm²) 适用电线大小	AVSSH0.75
Material 材质	Heat-resistant copper alloy
Surface treatment 表面处理	Tin-plated 镀锡

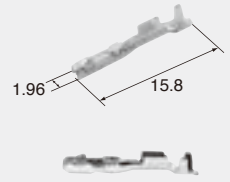
**1.0mm (040)****(S)****F (8240-0411)**

Cable size (mm²) 适用电线大小	AVSSH0.3 ~AVSSH0.5
Material 材质	Heat-resistant copper alloy
Surface treatment 表面处理	Tin-plated 镀锡

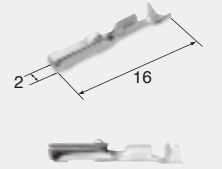
**(M)****F (8240-0412)**

Cable size (mm²) 适用电线大小	AVSSH0.75 ~AVSSH1.25
Material 材质	Heat-resistant copper alloy
Surface treatment 表面处理	Tin-plated 镀锡

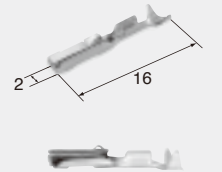
**Terminal (UNIT : mm)**

端子(毫米)

0.64mm, 1.0mm (025, 040)**Dummy plugs (UNIT : mm)**

盲塞(毫米)

- Dummy plugs are common to M and F.
- Dummy plugs are used to blind unused terminal holes.
- 盲塞为公端、母端共用。
- 盲塞用于堵塞不使用的端子孔。

(6914-0127)

Material 材质	PBT
Color 颜色	Blue 蓝



0.64mm, 1.0mm
(025,040)

Housing (UNIT: mm)

接插件护套(毫米)

Ref: Terminal part No. 端子参照页	[0.64mm] [1.0mm]	E-10 E-11
Ref: Dummy plug No. 盲塞参照页	[0.64mm] [1.0mm]	E-11 E-11
Material 材质	PBT	

22way (10+12)

Joint Connector

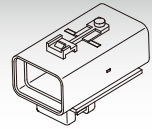

Coupling circuit is connected with busbers as shown gray hatched cavities.

M (5011-6818)

Color: Brown
颜色: 棕

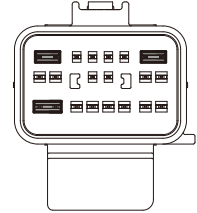
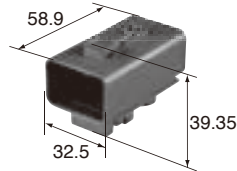

M (5011-7740)

Color: Black
颜色: 黑

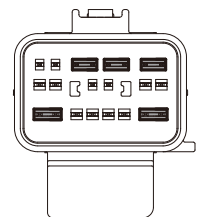
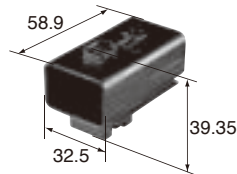

M (5011-7860)

Color: Dark Gray
颜色: 深灰

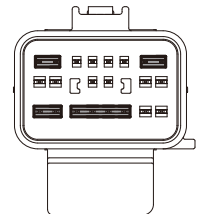
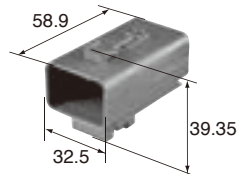

F (6189-7264) Lever

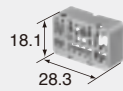
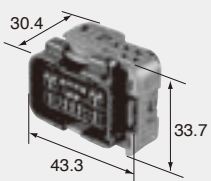

Retainer No. (6918-3166)

Color: Black
颜色: 黑

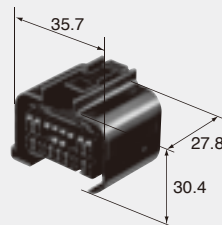

Lock F (6189-7263)



Retainer No. (6918-3166)

Color: Black
颜色: 黑

HX SEALED SERIES for STANDARD

1.5mm (060)

Structure / 构造

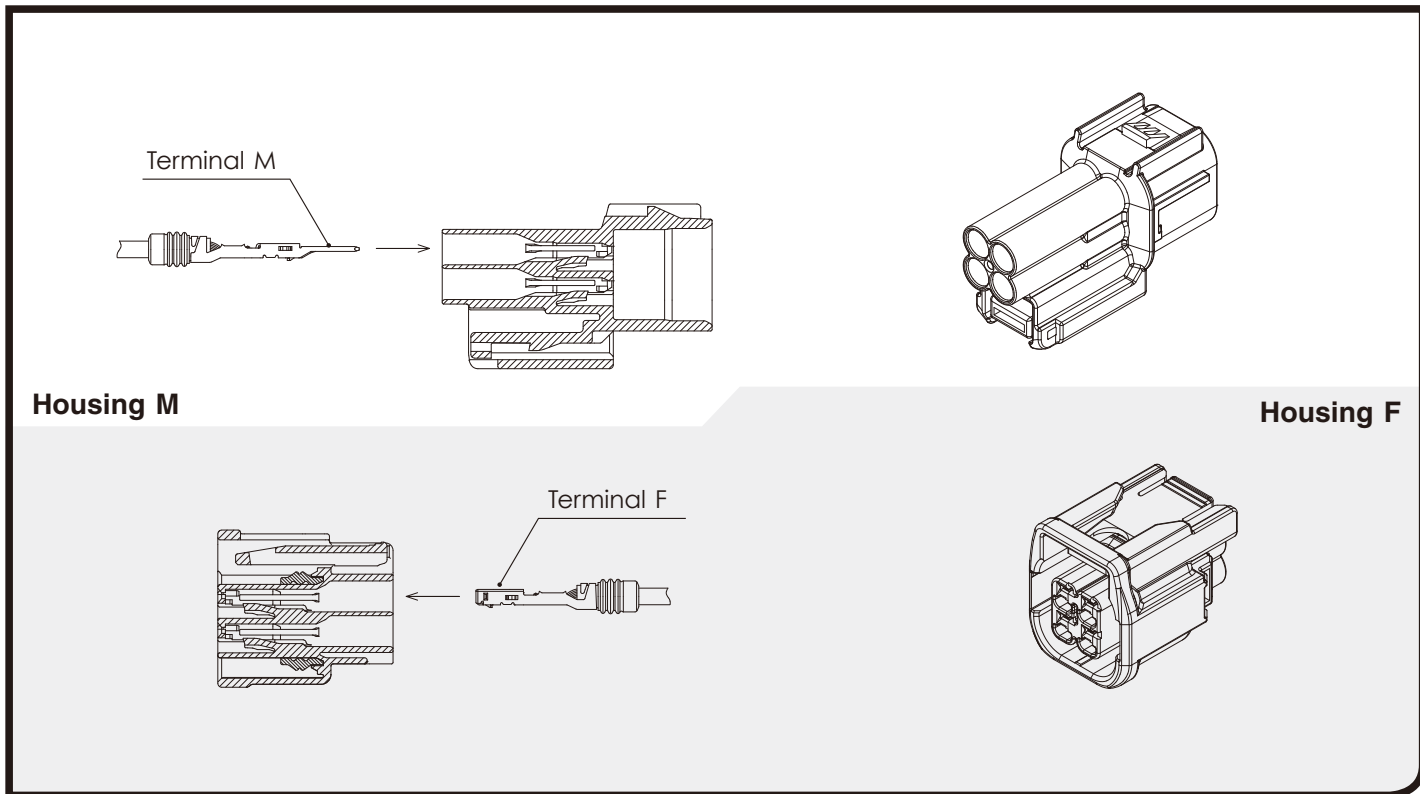

E-13

HX SEALED SERIES

1.5mm (060)

Terminal (UNIT : mm)

端子(毫米)

(SS)

Cable size (mm ²) 适用电线大小	0.13~0.22
---	-----------

Material 材质	Brass 黄铜
----------------	-------------

Surface treatment 表面处理	Tin-plated 镀锡
---------------------------	------------------

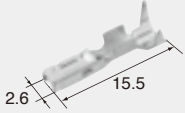
**M (8230-5306)****F (8240-0489)**

Cable size (mm ²) 适用电线大小	0.13~0.22
---	-----------

Material 材质	Heat-resistant copper alloy
----------------	--------------------------------

Surface treatment 表面处理	Tin-plated 镀锡
---------------------------	------------------

(S)

Cable size (mm ²) 适用电线大小	0.3~0.5
---	---------

Material 材质	Brass 黄铜
----------------	-------------

Surface treatment 表面处理	Tin-plated 镀锡
---------------------------	------------------

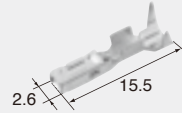
**M (8230-5307)****F (8240-0490)**

Cable size (mm ²) 适用电线大小	0.3~0.5
---	---------

Material 材质	Heat-resistant copper alloy
----------------	--------------------------------

Surface treatment 表面处理	Tin-plated 镀锡
---------------------------	------------------

(M)

Cable size (mm ²) 适用电线大小	0.75~1.25
---	-----------

Material 材质	Brass 黄铜
----------------	-------------

Surface treatment 表面处理	Tin-plated 镀锡
---------------------------	------------------

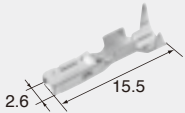
**M (8230-5308)****F (8240-0491)**

Cable size (mm ²) 适用电线大小	0.75~1.25
---	-----------

Material 材质	Heat-resistant copper alloy
----------------	--------------------------------

Surface treatment 表面处理	Tin-plated 镀锡
---------------------------	------------------

(L)

Cable size (mm ²) 适用电线大小	2.0
---	-----

Material 材质	Brass 黄铜
----------------	-------------

Surface treatment 表面处理	Tin-plated 镀锡
---------------------------	------------------

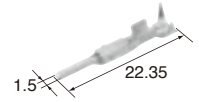
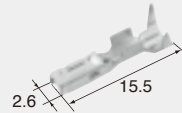
**M (8230-5309)****F (8240-0492)**

Cable size (mm ²) 适用电线大小	2.0
---	-----

Material 材质	Heat-resistant copper alloy
----------------	--------------------------------

Surface treatment 表面处理	Tin-plated 镀锡
---------------------------	------------------

1.5mm (060)**Wire seals (UNIT : mm)**

电线密封栓(毫米)

电线密封栓为公端、母端共用。

(SS)**(7165-1562)**

Cable overall diameter (mm) 带绝缘层外径	0.85~1.2
---------------------------------------	----------

Material 材质	Silicon 硅
----------------	--------------

Color 颜色	Violet 紫
-------------	-------------

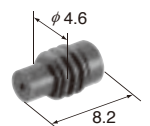

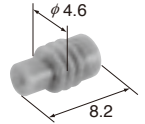
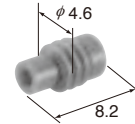
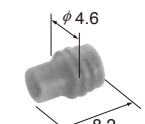
(S)**(7165-1563)**Cable overall diameter (mm)
带绝缘层外径 1.05~1.5Material
材质 Silicon
硅Color
颜色 Sky Blue
天蓝**(M)****(7165-1564)**Cable overall diameter (mm)
带绝缘层外径 1.35~1.9Material
材质 Silicon
硅Color
颜色 Light Green
淡绿**(L)****(7165-1565)**Cable overall diameter (mm)
带绝缘层外径 1.75~2.4Material
材质 Silicon
硅Color
颜色 Blue
蓝**(LL)****(7165-1566)**Cable overall diameter (mm)
带绝缘层外径 2.4~3Material
材质 Silicon
硅Color
颜色 Dark Yellow
深黄色

1.5mm (060)

Dummy plugs (UNIT : mm)

盲塞 (毫米)

Ref; 1.5mm Dummy plug detail

1.5mm盲塞参照页

(7165-0193) J-07

- Dummy plugs are common to M and F.
- Dummy plugs are used to blind unused terminal holes.
- 盲塞为公端、母端共用。
- 盲塞用于堵塞不使用的端子孔。

1.5mm (060)

Housing (UNIT : mm)

接插件护套 (毫米)

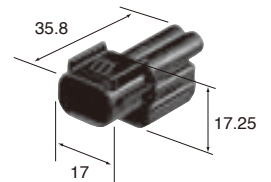
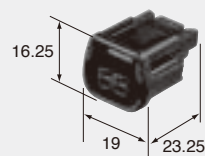
Ref: Terminal part No. E-14
端子参照页Ref: wire seal No. E-14
电线密封栓参照页Ref: Dummy plug No. J-07
盲塞参照页Material PBT
材质**2way**Color Black
颜色 黑**M (6181-6851)****F (6189-7408)**Color Black
颜色 黑

3way

F (6189-7494)



Color 颜色 Black 黑

4way

Color 颜色 Black 黑

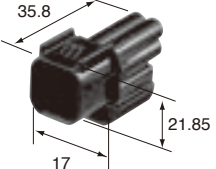

M (6181-6783)

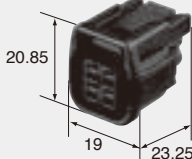

Color 颜色 Black 黑

F (6189-7409)

8way

Color 颜色 Black 黑

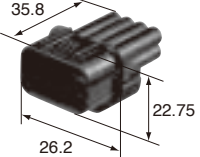

M (6181-6850)

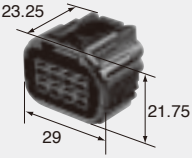

Color 颜色 Black 黑

F (6189-7423)

12way

Color 颜色 Black 黑

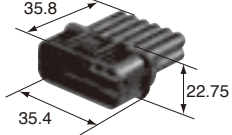

M (6181-6784)

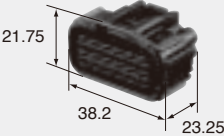

Color 颜色 Black 黑

F (6189-7410)

HX SEALED SERIES for STANDARD

2.3mm (090)

Structure / 构造

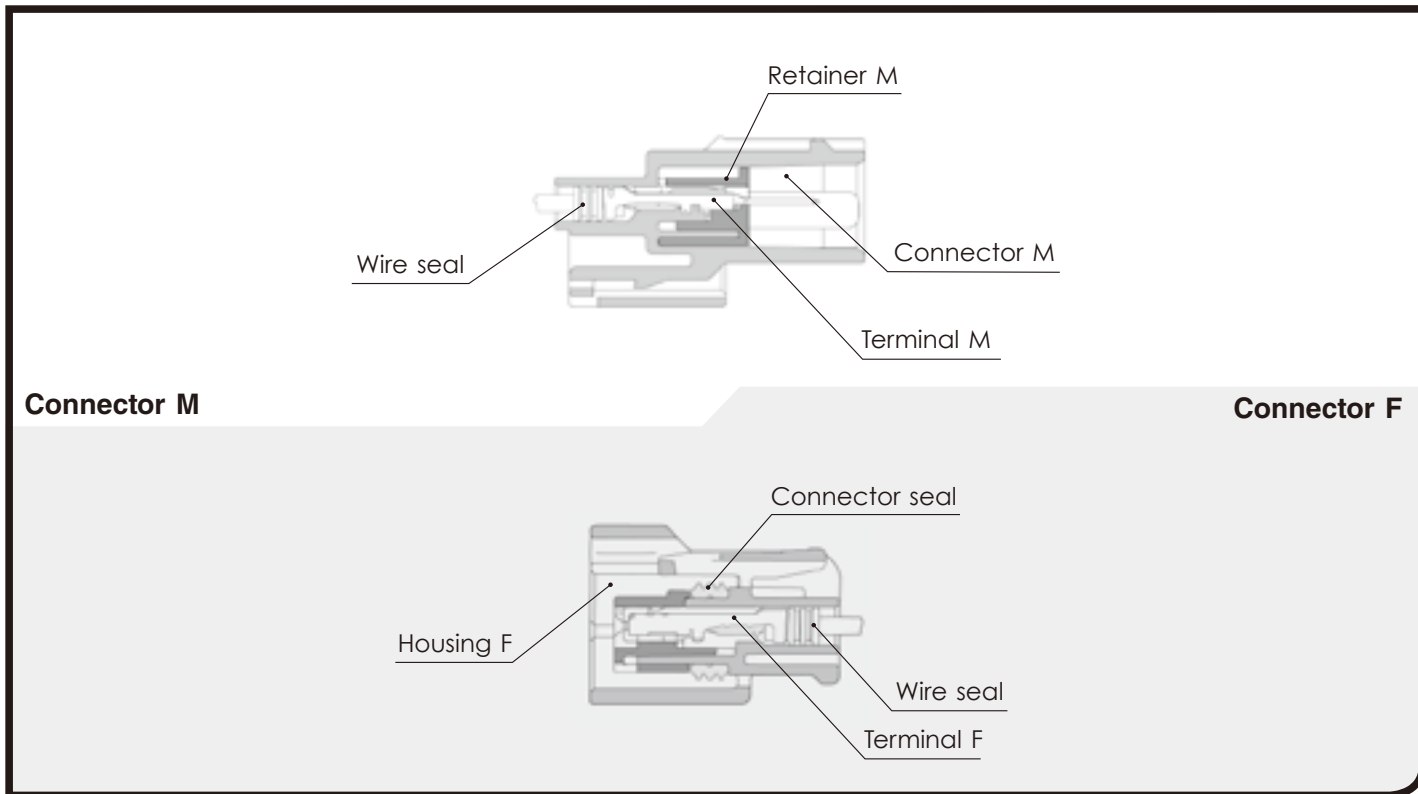

E-17

HX SEALED SERIES

2.3mm (090)

Terminal (UNIT : mm)

端子 (毫米)

Ref; 2.3mm Terminal detail
2.3mm端子参照页

S	M (8230-4472)	L-02
M	M (8230-4562)	L-02
L	M (8230-4552)	L-02

(S)		F (8240-4862)
Cable size (mm²) 适用电线大小	0.3~0.5	
Cable overall diameter (mm) 带绝缘层外径	1.4~2.4	
Material 材质	Heat-resistant copper alloy	
Surface treatment 表面处理	Tin-plated 镀锡	

(M)**F (8240-4992)**

Cable size (mm²) 适用电线大小	0.75~0.85
Cable overall diameter(mm) 带绝缘层外径	1.8~2.6
Material 材质	Heat-resistant copper alloy
Surface treatment 表面处理	Tin-plated 镀锡

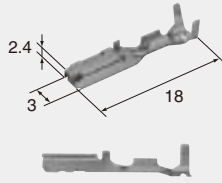
**(L)****F (8240-4952)**

Cable size (mm²) 适用电线大小	1.25~2.0
Cable overall diameter(mm) 带绝缘层外径	2.1~2.9
Material 材质	Heat-resistant copper alloy
Surface treatment 表面处理	Tin-plated 镀锡

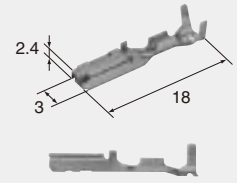
**2.3mm (090)****Wire seals (UNIT : mm)**

电线密封栓 (毫米)

The wire seals are common to M and F.

电线密封栓为公端、母端共用。

(SS)**(7165-0385)**

Cable size (mm²) 适用电线大小	(AVSS/0.3~0.5) (AVSSX/0.5)
Cable overall diameter(mm) 带绝缘层外径	1.2~1.7
Material 材质	Silicon 硅
Color 颜色	Gray 灰

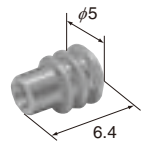
**(S)****(7165-0194)**

Cable size (mm²) 适用电线大小	(AV/0.5) (AVX/AEX/0.5~0.75) (AVS/0.3~0.85) (AVSS/0.85~1.25) (AVSSX/0.75~1.25)
Cable overall diameter(mm) 带绝缘层外径	1.7~2.4
Material 材质	Silicon 硅
Color 颜色	Green 绿

**(M)****(7165-0198)**

Cable size (mm²) 适用电线大小	(AV/0.5~1.25) (AVX/AEX/0.75~1.25) (AVS/0.85~1.25) (AVSS/1.25~2.0) (AVSSX/1.25~2.0)
Cable overall diameter(mm) 带绝缘层外径	2.1~2.9
Material 材质	Silicon 硅
Color 颜色	Yellow 黄

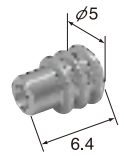
**2.3mm (090)****Dummy plugs (UNIT : mm)**

盲塞 (毫米)

Ref: 2.3mm Dummy plug detail

2.3mm盲塞参照页

(7165-0193) J-07

- Dummy plugs are common to M and F.
- Dummy plugs are used to blind unused terminal holes.
- 盲塞为公端、母端共用。
- 盲塞用于堵塞不使用的端子孔。

2.3mm (090)

Housing (UNIT : mm)

接插件护套(毫米)

Ref: Terminal part No. 端子参照页	E-17
Ref: wire seal No. 电线密封栓参照页	E-18
Ref: Dummy plug No. 盲塞参照页	J-07
Material 材质	PBT

1way

Color Black
颜色 黑

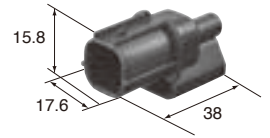
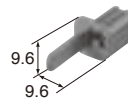

Retainer No. (6918-2665)

M (6181-0803)

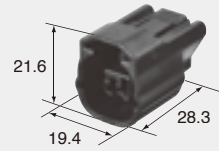

F (6189-0591)



Retainer No. (6918-1370)

Color Black
颜色 黑

2way

F (6189-0552)

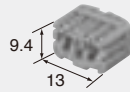
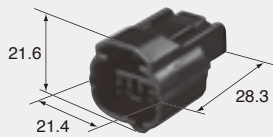

Note)

Retainer No. (6918-1260)

Color Black
颜色 黑

2way

(Rib difference) (Rib差异)

F (6189-0593)

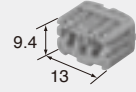
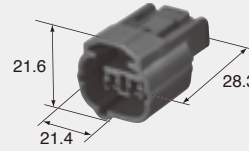

Note)

Retainer No. (6918-1260)

Color Brown
颜色 棕

3way

F (6189-0596)

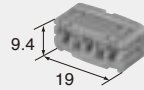
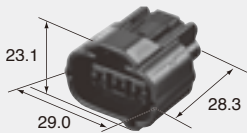

Note)

Retainer No. (6918-1371)

Color Black
颜色 黑

4way

F (6189-0617)

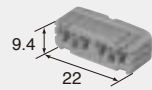
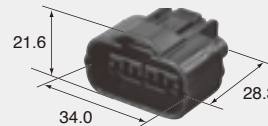

Note)

Retainer No. (6918-1469)

Color Black
颜色 黑

HX SEALED SERIES

for HYBRID

4.8mm (187)

Terminal (UNIT: mm)

端子(毫米)

Ref: 4.8mm Terminal detail
4.8mm端子参照页

S **M(8100-0463)** B-19

M **M(8100-0464)** B-19

L **M(8100-0465)** B-19 **F(8100-0468)** B-19

4.8mm (187)

Wire seals (UNIT: mm)

电线密封栓(毫米)

The wire seals are common to M and F.

电线密封栓为公端、母端共用。

(S)

Cable size (mm ²) 适用电线大小	0.3~0.5
Cable overall diameter (mm) 带绝缘层外径	1.4~2.4
Material 材质	Heat-resistant copper alloy
Surface treatment 表面处理	Tin-plated 镀锡

F(8100-0661)

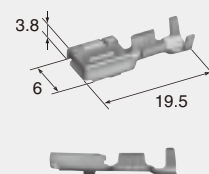

(M)

Cable size (mm ²) 适用电线大小	0.5~1.25
Cable overall diameter (mm) 带绝缘层外径	1.6~2.6
Material 材质	Heat-resistant copper alloy
Surface treatment 表面处理	Tin-plated 镀锡

F(8100-0660)

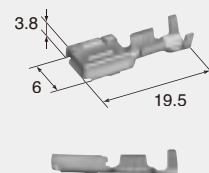

(S)

for 2.3mm, 4.8mm 10way

Cable size (mm ²) 适用电线大小	(AVS/0.3) (AVSS/0.3~0.85) (AVSSX/0.5~0.75)
Cable overall diameter (mm) 带绝缘层外径	1.4~1.9
Material 材质	NBR
Color 颜色	Brown 棕

(7165-0172)

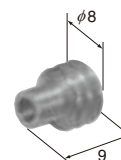

(M)

for 2.3mm, 4.8mm 10way

Cable size (mm ²) 适用电线大小	(AV/0.5~1.25) (AVX/0.5~1.25) (AVS/0.3~1.25) (AVSS/0.85~2.0) (AVSSX/0.75~2.0)
Cable overall diameter (mm) 带绝缘层外径	1.8~2.9
Material 材质	NBR
Color 颜色	Gray 灰

(7165-0130)



(L)

for 2.3mm, 4.8mm 10way

(7165-0131)

Cable size (mm²) (AV/2.0~3.0) (AVX/2.0~3.0)
 适用电线大小 (AVS/2.0~3.0)

Cable overall diameter(mm)
 带绝缘层外径 3.0~4.1

Material
 材质 NBR

Color
 颜色 Black
 黑

**(M)**

for 1.0mm, 4.8mm 13way

(7165-0147)

Cable size (mm²) (AVS/0.3~1.25)

Cable overall diameter(mm)
 带绝缘层外径 1.8~2.9

Material
 材质 Silicon
 硅

Color
 颜色 Dark Green
 墨绿

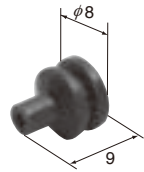
**(L)**

for 1.0mm, 4.8mm 13way

(7165-0148)

Cable size (mm²) (AVS/2.0~3.0)

Cable overall diameter(mm)
 带绝缘层外径 3.0~4.1

Material
 材质 Silicon
 硅

Color
 颜色 Dark Blue
 藏青

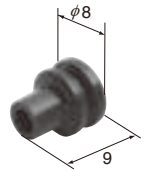

1.0mm, 4.8mm (040, 187)

Housing (UNIT : mm)

接插件护套(毫米)

Ref: Terminal part No. [1.0mm] E-02
 端子参照页 [4.8mm] E-20

Ref: wire seal No. [1.0mm] E-03
 电线密封栓参照页 [4.8mm] E-21

Ref: Dummy plug No. [1.0mm] E-04
 盲塞参照页 [4.8mm] B-21

Material
 材质 PBT

No. of way/ () corresponds to 1.0mm, 4.8mm, in order from left to right.
 极数 / () 内显示 : 从左向右为1.0mm 极数、4.8mm 极数

13way (12+1)

Color
 颜色 Black
 黑

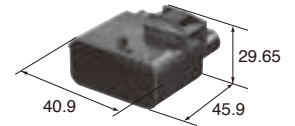
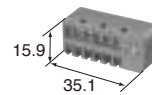

Retainer No. (6181-6465)

M (6181-6464)

F (6189-6863)

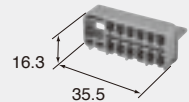
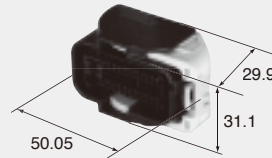

Retainer No. (6185-4596)

Color
 颜色 Black
 黑

1.5mm, 4.8mm (060, 187)

Housing (UNIT : mm)

接插件护套(毫米)

Ref: Terminal part No. [1.5mm] E-14
 端子参照页 [4.8mm] E-20

Ref: wire seal No. [1.5mm] E-15
 电线密封栓参照页 [4.8mm] E-20

Ref: Dummy plug No. [1.5mm] J-07
 盲塞参照页 [4.8mm] B-21

Material
 材质 PBT

No. of way/ () corresponds to 1.5mm, 4.8mm, in order from left to right.
 极数 / () 内显示 : 从左向右为1.5mm 极数、4.8mm 极数

4way (2+2)

Color
 颜色 Black
 黑

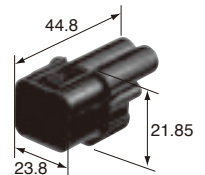

M (6181-6785)

F (6189-7411)

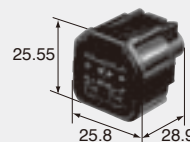

Color
 颜色 Black
 黑

E-21

HX SEALED SERIES

5way (3+2)

Color Dark gray
颜色 深灰

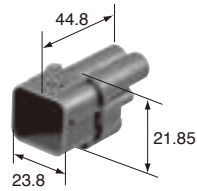

M (6181-6921)

F (6189-7567)

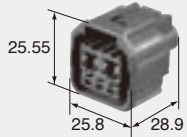

Color Dark gray
颜色 深灰

2.3mm, 4.8mm (090, 187)

Housing (UNIT : mm)

接插件护套(毫米)

Ref: Terminal part No. [2.3mm] E-17
端子参照页 [4.8mm] E-20

Ref: wire seal No. [2.3mm] E-18
电线密封栓参照页 [4.8mm] E-21

Ref: Dummy plug No. [2.3mm] J-07
盲塞参照页 [4.8mm] B-21

Material PBT
材质

No. of way/ () corresponds to 2.3mm, 4.8mm, in order from left to right.
极数 / () 内显示: 从左向右为2.3mm 极数、4.8mm 极数

10way (8+2)

Color Dark gray
颜色 深灰

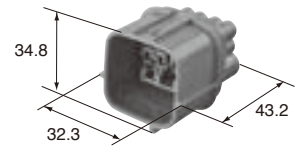
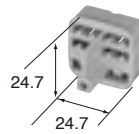

Retainer No. (6918-1263)

M (6181-0381)

F (6189-0555)

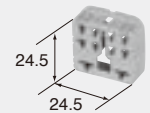
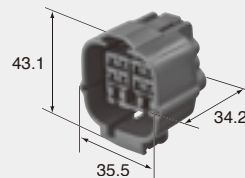

Retainer No. (6918-1267)

Color Dark gray
颜色 深灰

NH SERIES

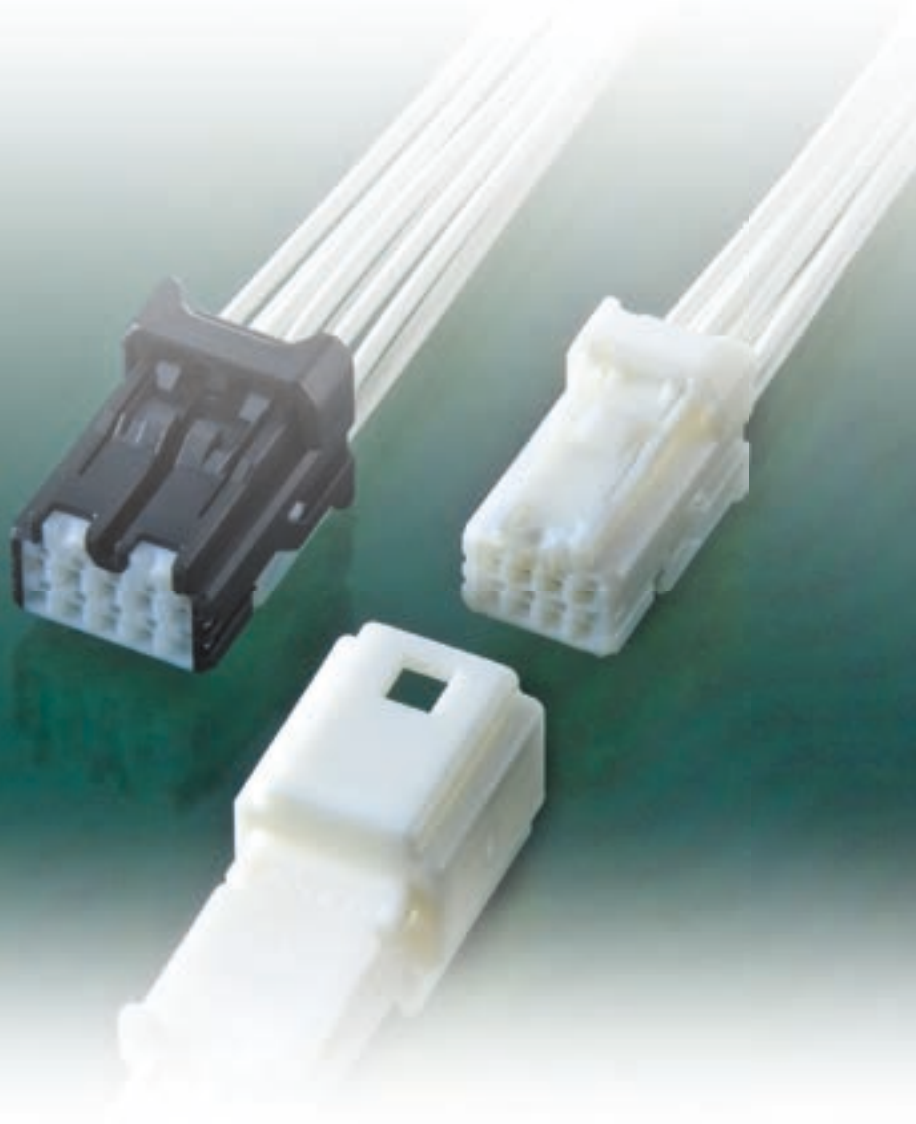

Features

The NH series connector is a highly reliable for connector mating and terminal insertion. This series consist of 0.64mm and hybrid type(0.64mm+2.3mm) terminal usable for control circuit and low power circuit.

- The front mask of Female connector assists allure male terminal.
- By setting TPA (Terminal Position Assurance) adjust the incomplete inserted terminal to the correct position.
- An extra clip can be attached to the connector housing to secure it to the body.
- RoHS/ELV Compliant

特点

NH 系列在接插件嵌合或端子插入不足等方面提高了可信性。

端子尺寸由0.64mm 与混合型 (0.64mm+2.3mm) 构成，可以应用于信号回路与低功率回路。

- 母端接插件由于采用了前锁制，在接插件嵌合时提高了公端子的引导性。
- 未完全插入的端子能够通过锁片的安装插入到正确的位置。
- 接插件护套能够安装夹钉以固定在车体上。
- 可对应欧盟 RoHS 和 ELV 指令

NH SERIES for STANDARD

0.64mm (025)

Structure / 构造

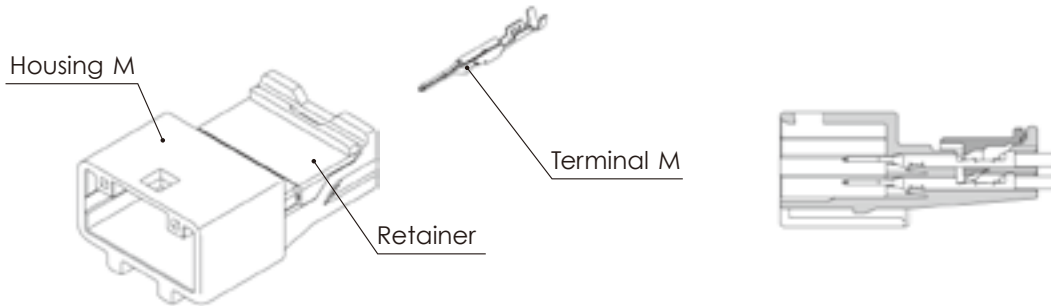

Connector M

Connector F

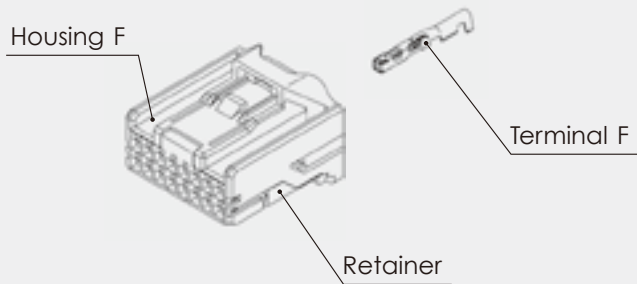

0.64mm (025)

Terminal (UNIT : mm)

端子(毫米)

(S)

Cable size (mm²) 适用电线大小	0.22~0.5
Material 材质	Brass 黄铜
Surface treatment 表面处理	Tin-plated 镀锡

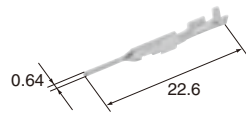
**(M)**

Cable size (mm²) 适用电线大小	0.75
Material 材质	Brass 黄铜
Surface treatment 表面处理	Tin-plated 镀锡

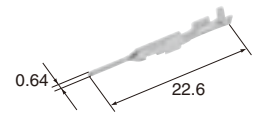
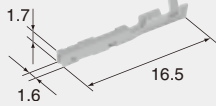
**M (8230-5379)****F (8240-0552)**

Cable size (mm²) 适用电线大小	0.22~0.5
Material 材质	Heat-resistant copper alloy
Surface treatment 表面处理	Tin-plated 镀锡

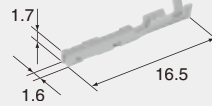
M (8230-5380)**F (8240-0523)**

Cable size (mm²) 适用电线大小	0.75
Material 材质	Heat-resistant copper alloy
Surface treatment 表面处理	Tin-plated 镀锡

F-03

NH SERIES

0.64mm (025)**Housing (UNIT : mm)**

接插件护套(毫米)

Ref: Terminal part No.
端子参照页

F-02

Material
材质

PBT

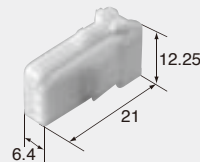
3way**F (6098-7063)**

Color
颜色

Natural
自然色**4way**

Color
颜色

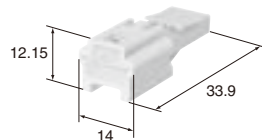
Natural
自然色**8way**

Color
颜色

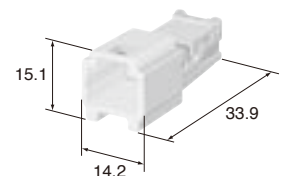
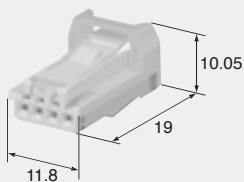
Natural
自然色**M (6098-5310)** TH 04 MW-NH TH 04 FW-NH **F (6098-5267)**

Color
颜色

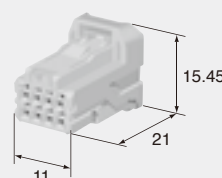
Natural
自然色**M (6098-5271)** TH 08 MW-NH TH 08 FW-NH **F (6098-5269)**

Color
颜色

Natural
自然色

8way

TH 08 FB-NH **F (6098-6451)**

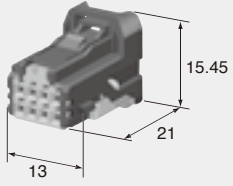

Color	Black
颜色	黑

8way

TH 08 FGY-NH **F (6098-6452)**

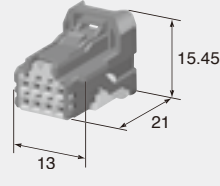

Color	Gray
颜色	灰

8way

TH 08 FL-NH **F (6098-6522)**

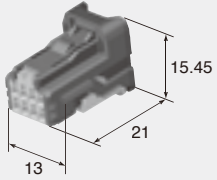

Color	Blue
颜色	蓝

8way

TH 08 FG-NH **F (6098-6523)**

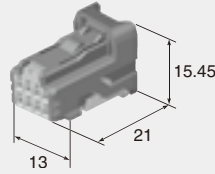

Color	Green
颜色	绿

8way

TH 08 FW-1V-NH **F (6098-5312)**

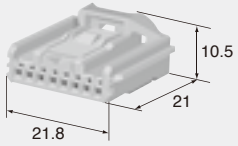

Color	Natural
颜色	自然色

10way

TH 10 FB-NH **F (6098-5273)**

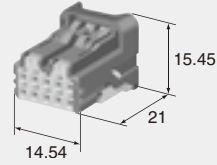

Color	Black
颜色	黑

10way

TH 10 FW-NH **F (6098-7066)**

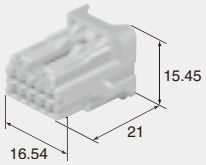

Color	Natural
颜色	自然色

10way

TH 10 FGY-NH **F (6098-7067)**

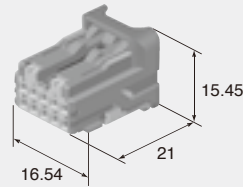

Color	Gray
颜色	灰

12way

Color	Natural
颜色	自然色

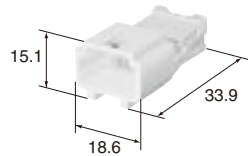

12way

TH 12 FB-NH **F (6098-6455)**

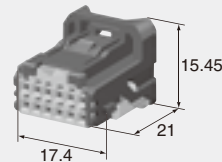

Color	Black
颜色	黑

M (6098-5277) TH 12 MW-NH TH 12 FW-NH **F (6098-5275)**

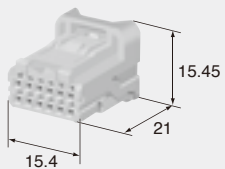

Color	Natural
颜色	自然色

12way

TH 12 FGY-NH **F (6098-6456)**

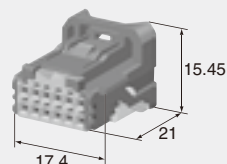

Color	Gray
颜色	灰

F-04

12way

TH 12 FL-NH **F (6098-6457)**

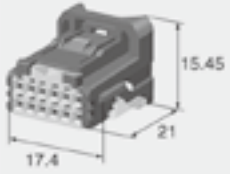

Color
颜色 Blue
蓝

12way

TH 12 FG-NH **F (6098-6524)**

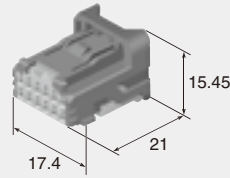

Color
颜色 Green
绿

16way

Color
颜色 Natural
自然色

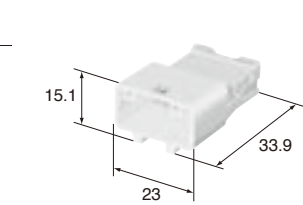

M (6098-5281) TH 16 MW-NH TH 16 FW-NH **F (6098-5279)**

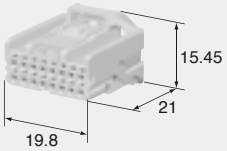

Color
颜色 Natural
自然色

16way

TH 16 FB-NH ASSY **F (6098-7099)**

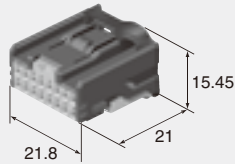

Color
颜色 Black
黑

16way

TH 16 FGY-NH ASSY **F (6098-7100)**

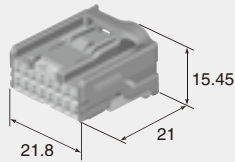

Color
颜色 Gray
灰

24way

Color
颜色 Natural
自然色

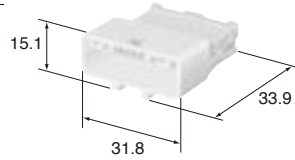

M (6098-5285) TH 24 MW-NH TH 24 FW-NH **F (6098-5283)**

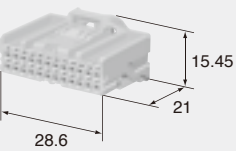

Color
颜色 Natural
自然色

24way

TH 24 FB-NH **F (6098-7060)**

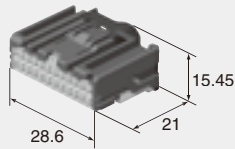

Color
颜色 Black
黑

24way

TH 24 FGY-NH **F (6098-7061)**

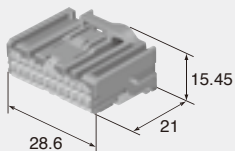

Color
颜色 Gray
灰

F-06

32way

Color 颜色 Natural 自然色

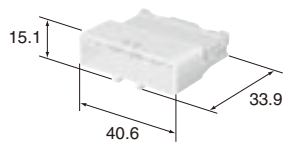

M (6098-5289) TH 32 MW-NH TH 32 FW-NH **F (6098-5287)**

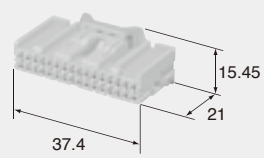

Color 颜色 Natural 自然色

40way

Color 颜色 Natural 自然色

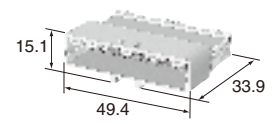

M (6098-5585) TH 40 MW-NH TH 40 FW-NH **F (6098-5291)**

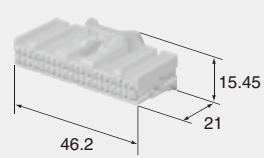

Color 颜色 Natural 自然色

40way

TH 40 FB-NH **F (6098-5293)**

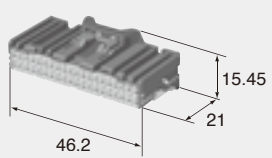

Color 颜色 Black 黑

40way

TH 40 FGY-NH **F (6098-5295)**

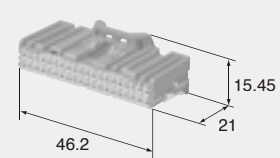

Color 颜色 Gray 灰

40way

TH 40 FG-NH **F (6098-5297)**

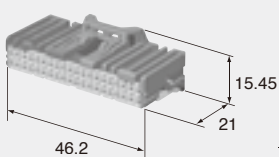

Color 颜色 Green 绿

NH SERIES for HYBRID

F-07

NH SERIES

2.3mm (090)

Terminal (UNIT : mm)

端子(毫米)

(SS)

Cable size (mm ²) 适用电线大小	0.22
Material 材质	Brass 黄铜
Surface treatment 表面处理	Tin-plated 镀锡

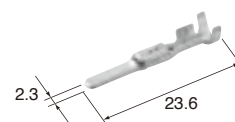

M (8230-5168)

F (8240-0367)

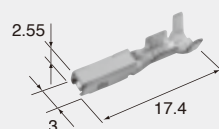

Cable size (mm ²) 适用电线大小	0.22
Material 材质	Heat-resistant copper alloy
Surface treatment 表面处理	Tin-plated 镀锡

(S)

Cable size (mm ²) 适用电线大小	0.3~0.5
Material 材质	Brass 黄铜
Surface treatment 表面处理	Tin-plated 镀锡

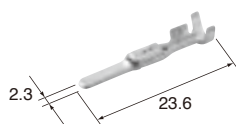

(M)

Cable size (mm ²) 适用电线大小	0.75~1.0
Material 材质	Brass 黄铜
Surface treatment 表面处理	Tin-plated 镀锡

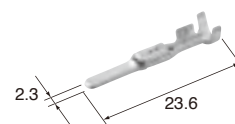

M (8230-5169)

F (8240-0368)

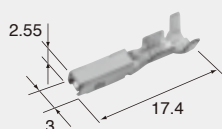

Cable size (mm ²) 适用电线大小	0.3~0.5
Material 材质	Heat-resistant copper alloy
Surface treatment 表面处理	Tin-plated 镀锡

M (8230-5170)

F (8240-0369)

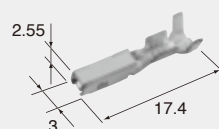

Cable size (mm ²) 适用电线大小	0.75~1.0
Material 材质	Heat-resistant copper alloy
Surface treatment 表面处理	Tin-plated 镀锡

(L)

Cable size (mm²) 适用电线大小	1.25
Material 材质	Brass 黄铜
Surface treatment 表面处理	Tin-plated 镀锡

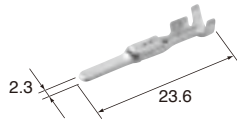
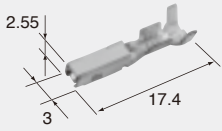
**M (8230-5171)****F (8240-0370)**

Cable size (mm²) 适用电线大小	1.25
Material 材质	Heat-resistant copper alloy
Surface treatment 表面处理	Tin-plated 镀锡

(LL)

Cable size (mm²) 适用电线大小	2.0~2.5
Material 材质	Brass 黄铜
Surface treatment 表面处理	Tin-plated 镀锡

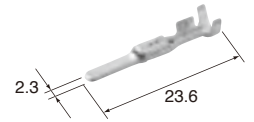
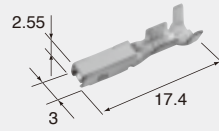
**M (8230-5172)****F (8240-0371)**

Cable size (mm²) 适用电线大小	2.0~2.5
Material 材质	Heat-resistant copper alloy
Surface treatment 表面处理	Tin-plated 镀锡

F-08

0.64mm, 2.3mm (025, 090)

Housing (UNIT : mm)

接插件护套(毫米)

Ref: Terminal part No. 端子参照页	[0.64mm] F-03	[2.3mm] F-07
--	---------------	--------------

Material 材质	PBT
-----------------------	-----

No. of way/ () corresponds to 0.64mm, 2.3mm, in order from left to right.
极数 / () 内显示: 从左向右为0.64mm 极数、2.3mm 极数

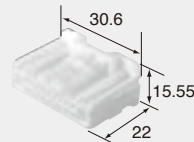
20way (18+2)NH 18 FW-CS2 **F (6098-7261)**

Color 颜色	Natural 自然色
--------------------	----------------

20way (10+10)

Color 颜色	Natural 自然色
--------------------	----------------

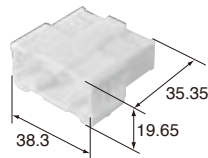
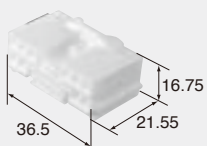
**M (6098-5989)** NH 10 MW-CS10 NH 10 FW-CS10 **F (6098-5988)**

Color 颜色	Natural 自然色
--------------------	----------------

20way (10+10)

Color 颜色	Black 黑
--------------------	------------

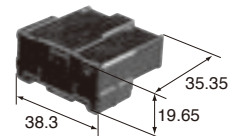
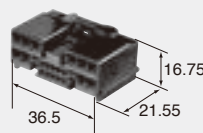
**M (6098-7254)** NH 10 MW-CS10-B NH 10 FW-CS10-B **F (6098-7253)**

Color 颜色	Black 黑
--------------------	------------

RS SERIES

A close-up photograph of several RS series connectors. The connectors are grey plastic with multiple copper-colored wires protruding from them. They are arranged on a dark, wet surface with water droplets, suggesting a rugged or industrial environment. The lighting is dramatic, with a bright light source from the top left creating a strong highlight and deep shadows.

Features

RS series consists of a 2.3mm type classified according to terminal size, supporting use in a variety of control circuits and low power circuits.

- The RS-standard type connectors adopt an inertia locking system to prevent semi-engagement (this system is not incorporated in some connectors).

*Please contact our sales representative for product numbers.

- RoHS/ELV Compliant

特点

RS 系列的端子尺寸由2.3mm 构成，可以应用于各种控制回路与低功率回路。

- RS 标准类型接插件采用惯性锁闭方式，使接插件不易发生半插入。
- 可对应欧盟 RoHS 和 ELV 指令

RS SERIES for STANDARD Type1

2.3mm (090)

Structure / 构造

G-02

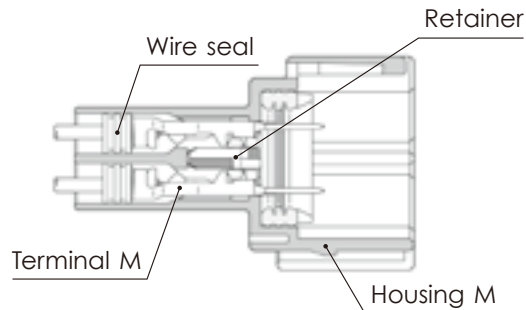
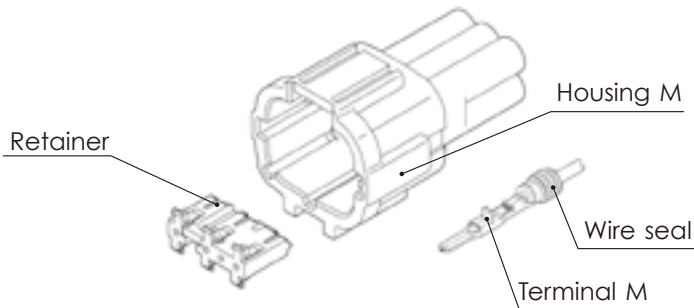

Connector M

Connector F

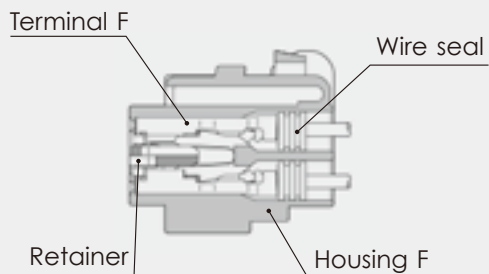
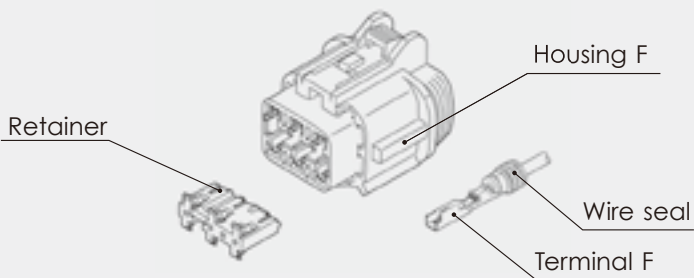

2.3mm (090)

Terminal (UNIT : mm)

端子(毫米)

(S)

Cable size (mm²) 适用电线大小	0.3~0.5
Material 材质	Brass 黄铜
Surface treatment 表面处理	Tin-plated 镀锡

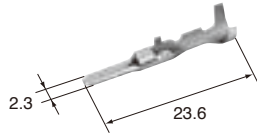
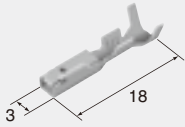
**M (8100-3803)****F (8240-0263)**

Cable size (mm²) 适用电线大小	0.3~0.5
Material 材质	Heat-resistant copper alloy
Surface treatment 表面处理	Tin-plated 镀锡

(S)**Au**

Cable size (mm²) 适用电线大小	0.3~0.5
Material 材质	Brass 黄铜
Surface treatment 表面处理	Gold-plated 镀金

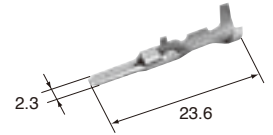
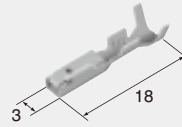
**M (8100-3805)****F (8240-0266)**

Cable size (mm²) 适用电线大小	0.3~0.5
Material 材质	Heat-resistant copper alloy
Surface treatment 表面处理	Gold-plated 镀金

(M)

Cable size (mm²) 适用电线大小	0.85~1.25
Material 材质	Brass 黄铜
Surface treatment 表面处理	Tin-plated 镀锡

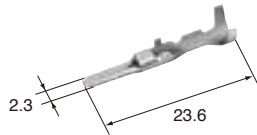
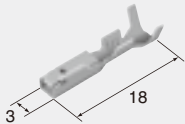
**M (8100-3804)****F (8240-0264)**

Cable size (mm²) 适用电线大小	0.85~1.25
Material 材质	Heat-resistant copper alloy
Surface treatment 表面处理	Tin-plated 镀锡

(M)**Au**

Cable size (mm²) 适用电线大小	0.85~1.25
Material 材质	Brass 黄铜
Surface treatment 表面处理	Gold-plated 镀金

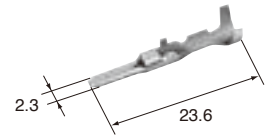
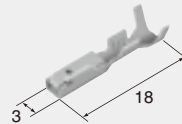
**M (8100-3806)****F (8240-0267)**

Cable size (mm²) 适用电线大小	0.85~1.25
Material 材质	Heat-resistant copper alloy
Surface treatment 表面处理	Gold-plated 镀金

(L)

Cable size (mm²) 适用电线大小	2.0
Material 材质	Brass 黄铜
Surface treatment 表面处理	Tin-plated 镀锡

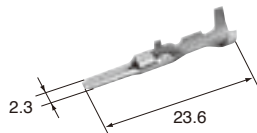
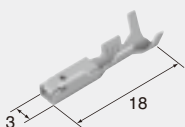
**M (8100-4172)****F (8240-0265)**

Cable size (mm²) 适用电线大小	2.0
Material 材质	Heat-resistant copper alloy
Surface treatment 表面处理	Tin-plated 镀锡

(L)**Au**

Cable size (mm²) 适用电线大小	2.0
Material 材质	Brass 黄铜
Surface treatment 表面处理	Gold-plated 镀金

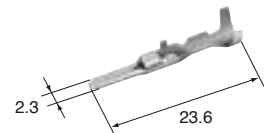
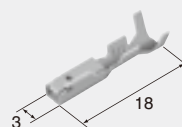
**M (8100-4173)****F (8240-0268)**

Cable size (mm²) 适用电线大小	2.0
Material 材质	Heat-resistant copper alloy
Surface treatment 表面处理	Gold-plated 镀金

G-03

RS SERIES

2.3mm (090)

Wire seals (UNIT : mm)

电线密封栓(毫米)

The wire seals are common to M and F.

电线密封栓为公端、母端共用。

(M)

(7165-0472)

Cable size (mm ²) 适用电线大小	(AVSS/1.25)
Cable overall diameter (mm) 带绝缘层外径	2.0~2.4
Material 材质	Silicon 硅
Color 颜色	Violet 紫



2.3mm (090)

Dummy plugs (UNIT : mm)

盲塞(毫米)

- Dummy plugs are common to M and F.
- Dummy plugs are used to blind unused terminal holes.
- 盲塞为公端、母端共用。
- 盲塞用于堵塞不使用的端子孔。

(US)

(7165-0474)

Cable size (mm ²) 适用电线大小	(AVSS/0.3) (CAVUS/0.3~0.5)
Cable overall diameter (mm) 带绝缘层外径	1.0~1.4
Material 材质	Silicon 硅
Color 颜色	Orange 橙



(S)

(7165-0473)

Cable size (mm ²) 适用电线大小	(AVSS/0.5~0.85) (CAVUS/0.85~1.25)
Cable overall diameter (mm) 带绝缘层外径	1.5~1.9
Material 材质	Silicon 硅
Color 颜色	Light Blue 淡蓝



(L)

(7165-0471)

Cable size (mm ²) 适用电线大小	(AVSS/2.0)
Cable overall diameter (mm) 带绝缘层外径	2.5~2.9
Material 材质	Silicon 硅
Color 颜色	Light Green 淡绿



(7165-1131)

Material 材质	Silicon 硅
Color 颜色	Blue 蓝

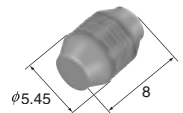

2.3mm (090)

Housing (UNIT : mm)

接插件护套(毫米)

Ref: Terminal part No. G-02
端子参照页

Ref: wire seal No. G-04
电线密封栓参照页

Ref: Dummy plug No. G-04
盲塞参照页

Material PBT
材质

※ Detail dimensions for mounting portion of the bracket are specified in the official drawing. Please contact our sales staff.

※关于固定用支架相关事宜, 请向敝公司销售负责人问讯。

1way

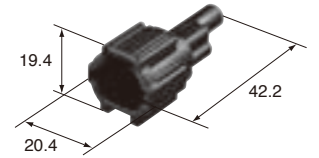
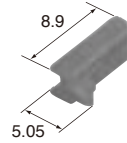

Retainer No. (6918-1773)

M (6188-0551) RS 01 MB

RS 01 FB **F (6185-0862)**

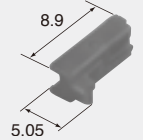
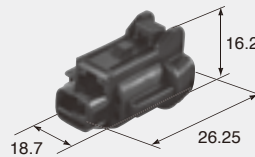

Retainer No. (6918-1773)

2way

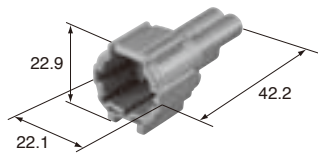
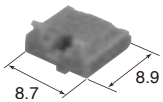

Retainer No. (6918-1774)

M (6188-0554) RS 02 MGY

RS 02 FGY **F (6185-0867)**

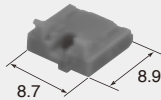
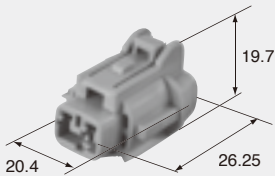

Retainer No. (6918-1774)

2way

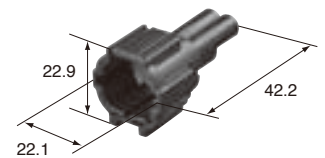
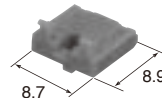

Retainer No. (6918-1774)

M (6188-0552) RS 02 MB

RS 02 FB **F (6185-0865)**

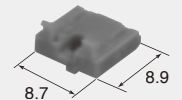
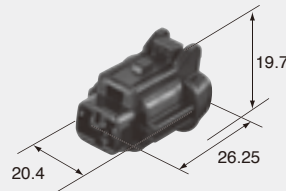

Retainer No. (6918-1774)

2way

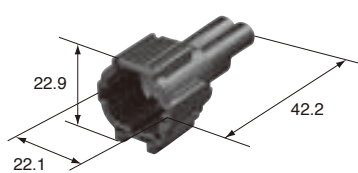
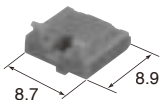

Retainer No. (6918-1774)

M (6188-0553) RS 02 MBR

M (6188-0663) RS 02 MBR-DGY

RS 02 FBR **F (6185-0866)**

RS 02 FBR-DGY **F (6185-1101)**

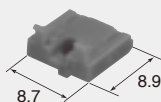
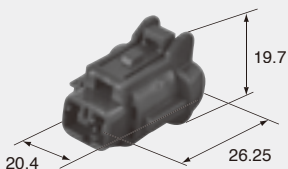

Retainer No. (6918-1774)

3way

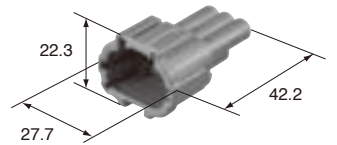
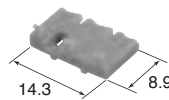

Retainer No. (6918-1775)

M (6188-0556) RS 03 MGY

RS 03 FGY **F (6185-0869)**

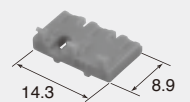
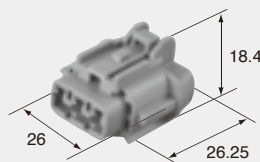

Retainer No. (6918-1775)

G-05

RS SERIES

3way

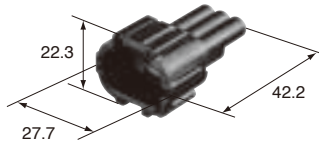
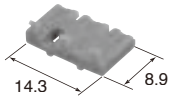

Retainer No. (6918-1775)

M (6188-0555) RS 03 MB

RS 03 FB **F (6185-0868)**

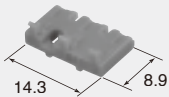

Retainer No. (6918-1775)

4way

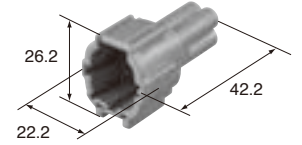
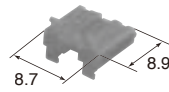

Retainer No. (6918-1776)

M (6188-0558) RS 04 MGY

RS 04 FGY-PR **F (6185-1171)**

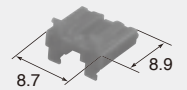
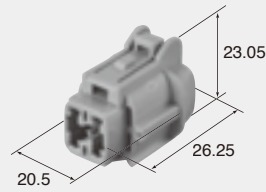

Retainer No. (6918-1776)

G-06

4way

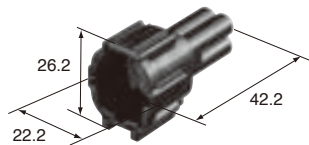
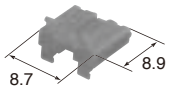

Retainer No. (6918-1776)

M (6188-0557) RS 04 MB

RS 04 FB-PR **F (6185-1169)**

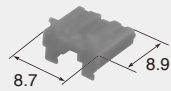
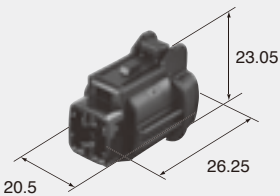

Retainer No. (6918-1776)

6way

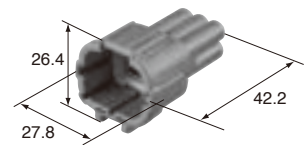
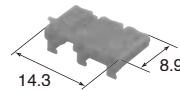

Retainer No. (6918-1779)

M (6188-5540) RS 06 MGY

RS 06 FGY-PR **F (6185-5177)**

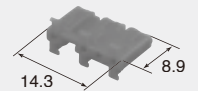
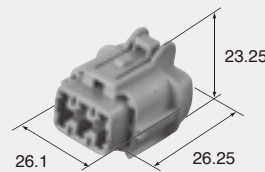

Retainer No. (6918-1779)

6way

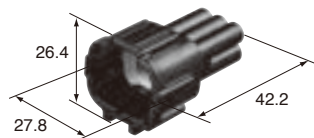
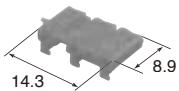

Retainer No. (6918-1779)

M (6188-5539) RS 06 MB

RS 06 FB-PR **F (6185-5175)**

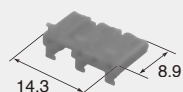
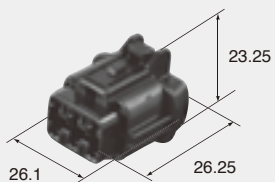

Retainer No. (6918-1779)

8way

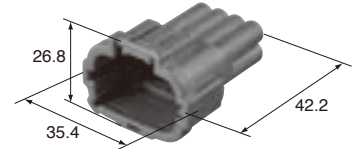
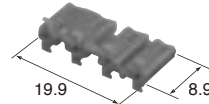

Retainer No. (6918-1780)

M (6188-5544) RS 08 MGY-PR

RS 08 FGY-PR **F (6185-5181)**

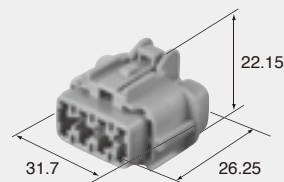

Retainer No. (6918-1780)

8way

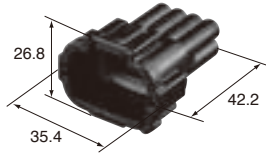
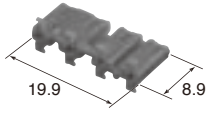

Retainer No. (6918-1780)

M (6188-5542) RS 08 MB-PR

RS 08 FB-PR **F (6185-5179)**

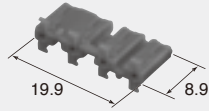
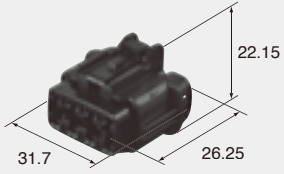

Retainer No. (6918-1780)

RS SERIES for STANDARD Type2

2.3mm (090)

Structure / 构造

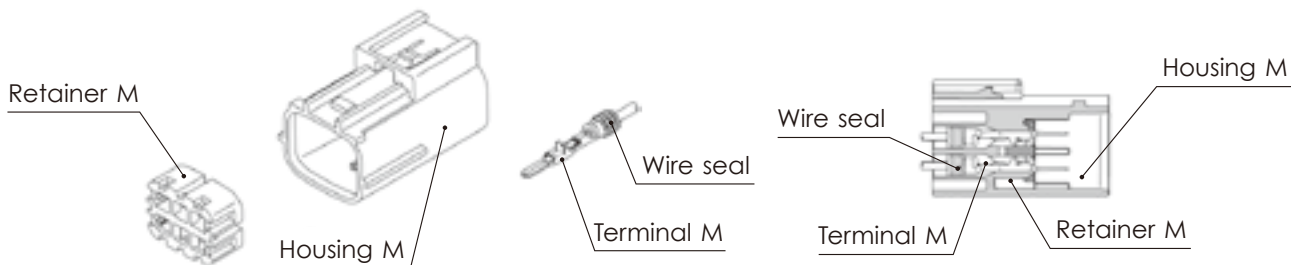

Connector M

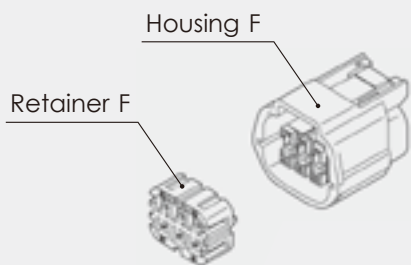

Connector F

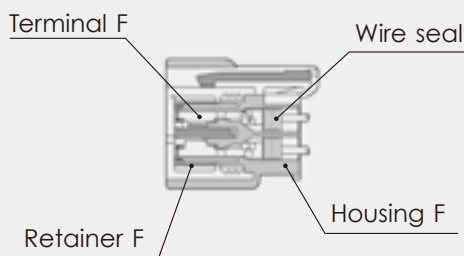

2.3mm (090)

Housing (UNIT : mm)

接插件护套(毫米)

Ref: Terminal part No. G-02
端子参照页

Ref: wire seal No. G-04
电线密封栓参照页

Ref: Dummy plug No. G-04
盲塞参照页

Material PBT
材质

2way

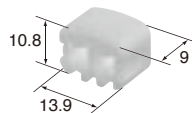

Retainer No. (6918-1653)

M (6181-0515) RS 02 MSB
M (6181-0670) RS 02 MSB-B

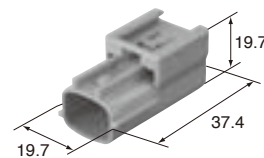

RS 02 FSB **F (6189-0951)**
RS 02 FSB-B **F (6189-1107)**

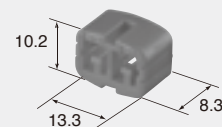
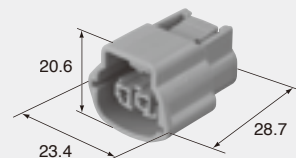

Retainer No. (6918-1651)

2way

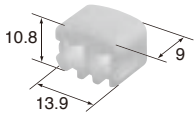

Retainer No. (6918-1653)

M (6181-0532) RS 02 MLGY

RS 02 FLGY **F (6189-0950)**

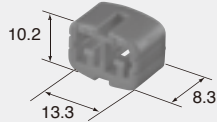
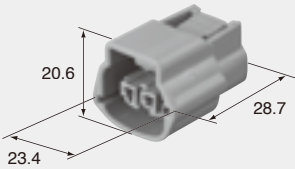
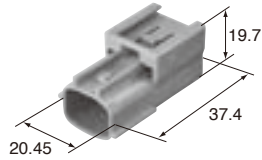

Retainer No. (6918-1651)

3way

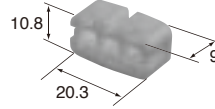

Retainer No. (6918-1654)

M (6181-0516) RS 03 MSB

M (6181-0671) RS 03 MSB-GY

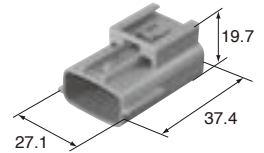

RS 03 FSB **F (6189-0928)**
RS 03 FSB-GY **F (6189-1104)**

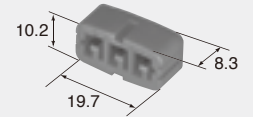
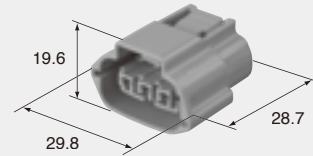

Retainer No. (6918-1652)

4way

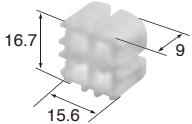

Retainer No. (6918-1598)

M (6181-0513) RS 04 MG

M (6181-0668) RS 04 MG-GY

RS 04 FG **F (6189-7756)**

RS 04 FG-GY **F (6189-7757)**

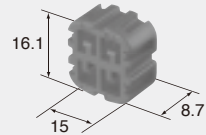
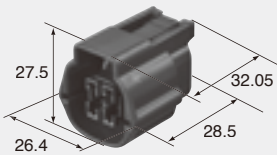
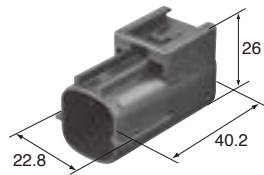

Retainer No. (6918-1599)

4way

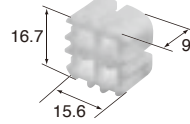

Retainer No. (6918-1598)

M (6181-0514) RS 04 ML

M (6181-0669) RS 04 ML-B

RS 04 FL **F (6189-7758)**

RS 04 FL-B **F (6189-7759)**

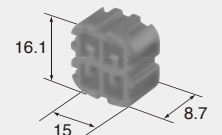
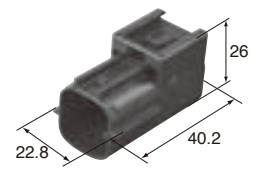

Retainer No. (6918-1599)

6way

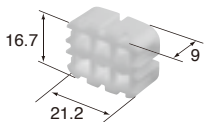

Retainer No. (6918-1600)

M (6181-0511) RS 06 MG

M (6181-0665) RS 06 MG-DGY

RS 06 FG **F (6189-7760)**

RS 06 FG-DGY **F (6189-7761)**

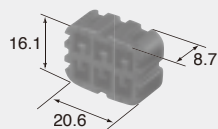
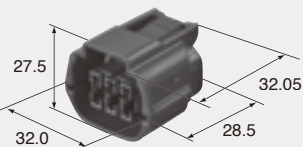
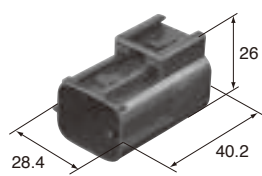

Retainer No. (6918-1601)

6way

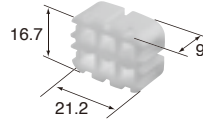

Retainer No. (6918-1600)

M (6181-0536) RS 06 ML

M (6181-0664) RS 06 ML-B

RS 06 FL **F (6189-7762)**

RS 06 FL-B **F (6189-7763)**

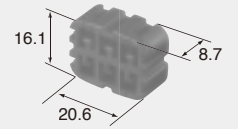
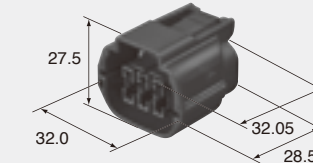
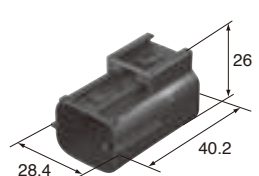

Retainer No. (6918-1601)

8way

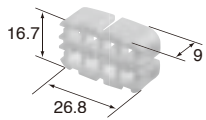

Retainer No. (6918-1602)

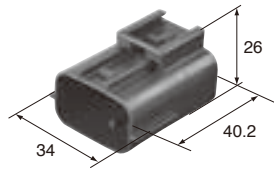

M (6181-0512) RS 08 MG

M (6181-0667) RS 08 MG-GY

RS 08 FG **F (6189-0954)**

RS 08 FG-GY **F (6189-1108)**

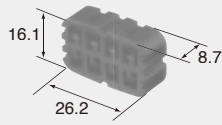
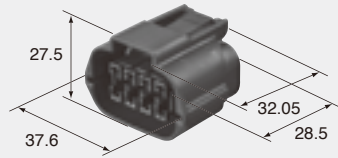

Retainer No. (6918-1603)

8way

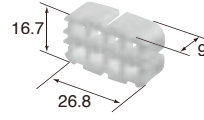

Retainer No. (6918-1602)

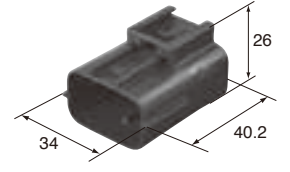

M (6181-0522) RS 08 ML

M (6181-0666) RS 08 ML-B

RS 08 FL **F (6189-0955)**

RS 08 FL-B **F (6189-1109)**

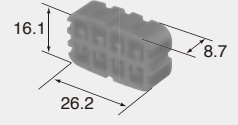
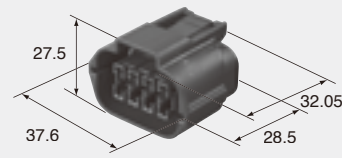

Retainer No. (6918-1603)

RS SERIES for E-RS

2.3mm (090)

Structure / 构造

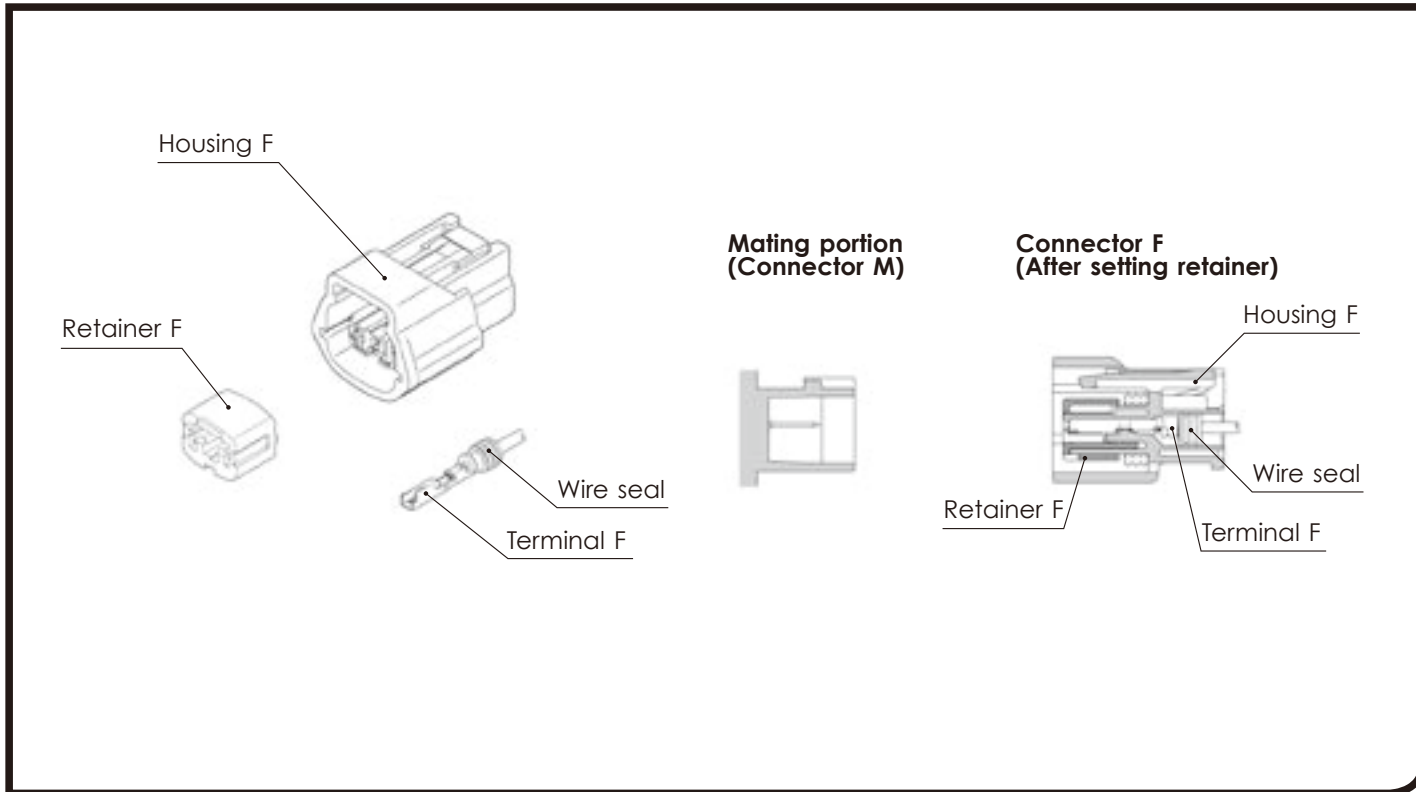

G-11

RS SERIES

2.3mm (090)

Housing (UNIT : mm)

接插件护套(毫米)

Ref: Terminal part No. G-02
端子参照页

Ref: wire seal No. G-04
电线密封栓参照页

Ref: Dummy plug No. G-04
盲塞参照页

Material PBT
材质

1way

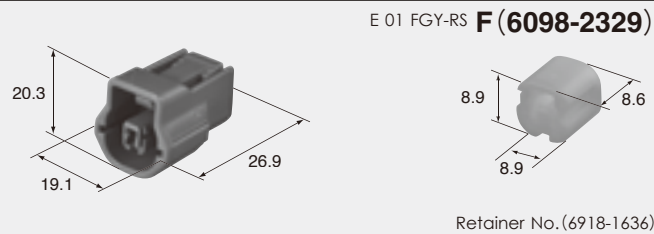

2way

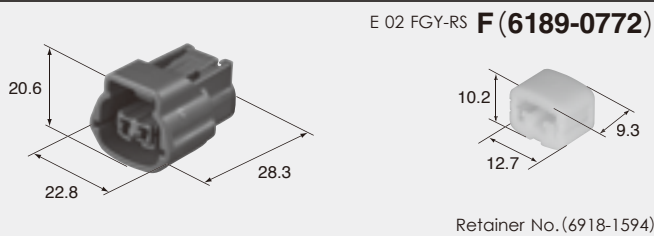

2way

E 02 FB-RS **F (6189-0773)**

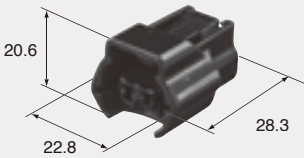

20.6
22.8
28.3

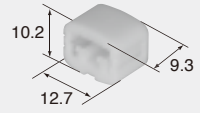

10.2
12.7
9.3

Retainer No. (6918-1594)

2way

E 02 FBR-RS **F (6189-0774)**
E 02 FBR-RS-GY **F (6189-1093)**

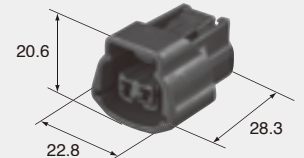

20.6
22.8
28.3



10.2
12.7
9.3

Retainer No. (6918-1594)

2way

E 02 FG-RS **F (6189-0775)**
E 02 FG-RS-LGY **F (6189-1094)**

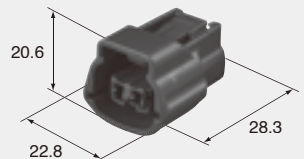

20.6
22.8
28.3

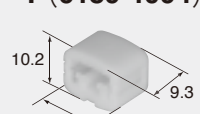

10.2
12.7
9.3

Retainer No. (6918-1594)

2way

E 02 FR-RS **F (6189-0776)**
E 02 FR-RS-GY **F (6189-1095)**

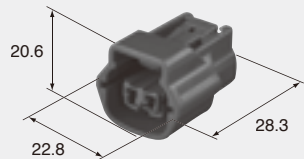

20.6
22.8
28.3



10.2
12.7
9.3

Retainer No. (6918-1594)

2way

E 02 FL-RS **F (6189-0777)**
E 02 FL-RS-LGY **F (6189-1096)**



20.6
22.8
28.3



10.2
12.7
9.3

Retainer No. (6918-1594)

2way

E 02 FPU-RS **F (6189-0778)**
E 02 FPU-RS-B **F (6189-1097)**

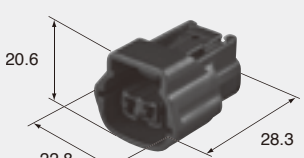

20.6
22.8
28.3



10.2
12.7
9.3

Retainer No. (6918-1594)

3way

E 03 FGY-RS **F (6189-7471)**

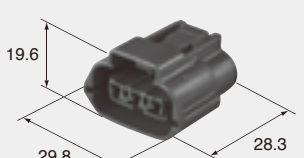

19.6
29.8
28.3



10.2
19.7
9.3

Retainer No. (6918-1595)

3way

E 03 FBR-RS **F (6189-7710)**
E 03 FBR-RS-B **F (6189-7711)**

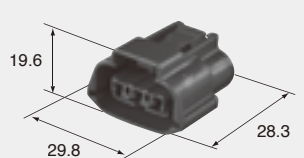

19.6
29.8
28.3



10.2
19.7
9.3

Retainer No. (6918-1595)

4way

E 04 FGY-RS **F (6189-7469)**

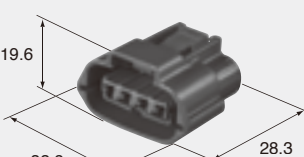

19.6
32.8
28.3

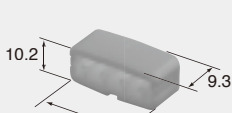

10.2
22.7
9.3

Retainer No. (6918-1596)

4way

E 04 FBR-RS **F (6189-7713)**
E 04 FBR-RS-LGY **F (6189-7714)**

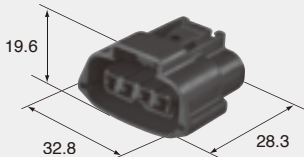

19.6
32.8
28.3



10.2
22.7
9.3

Retainer No. (6918-1596)

5way

E 05 FGY-RS **F (6189-7470)**

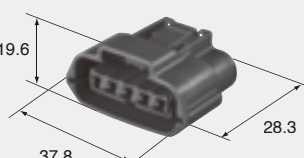

19.6
37.8
28.3



10.2
27.7
9.3

Retainer No. (6918-1604)

5way

E 05 FBR-RS **F (6189-7716)**
E 05 FBR-RS-B **F (6189-7717)**

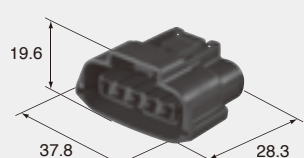

19.6
37.8
28.3



10.2
27.7
9.3

Retainer No. (6918-1604)

6way

E 06 FGY-RS **F (6189-7393)**

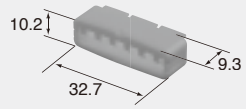
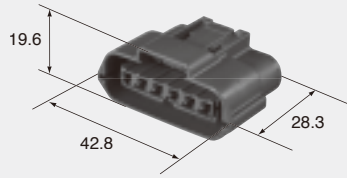

Retainer No. (6918-1597)

TL SEALED SERIES



Features

The TL sealed connector series has a mechanism that detects terminal incomplete insertion by using a dedicated jig.

This series consists of 2.3mm type supporting use in a variety of control circuits and low power circuits.

- To restrain from incomplete engagement, this series is adopted a lock mechanism with effective clear sound.
- These male connectors can be directly secured to a bracket on the car body.
(Note: Please contact our sales staff, if you have any questions regarding the dedicated jig.)
- RoHS/ELV Compliant

特点

TL 防水系列采用了以专用治具检测出端子半插入的构造。

TL 系列的端子尺寸由2.3mm 构成，可以应用于各种控制回路与低功率回路。

- 为防止接插件半嵌合的发生，采用了增强锁闭音的锁闭构造。
- 公端接插件可以直接固定在车体支架上。

注意：有关专用导通治具的详情请向敝公司销售负责人确认。

- 可对应欧盟 RoHS 和 ELV 指令

TL SEALED SERIES for STANDARD

2.3mm (090)

Structure / 构造

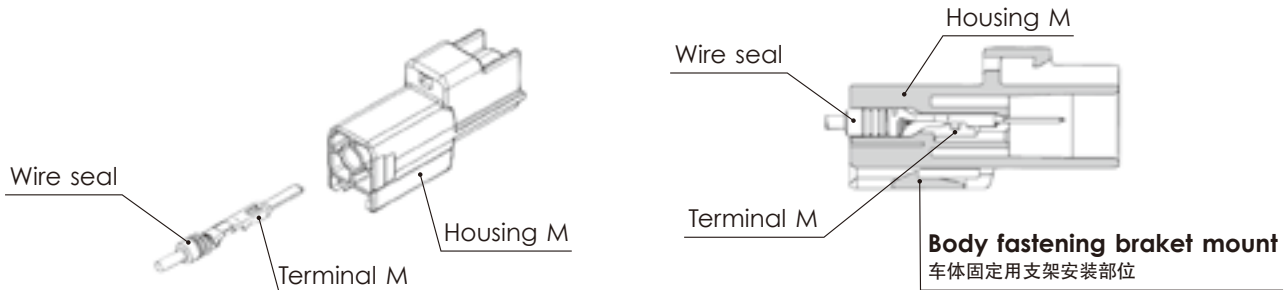

Connector M

Connector F

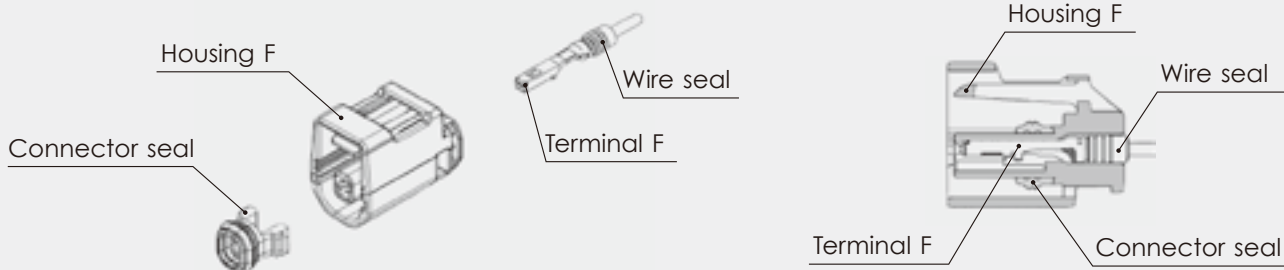

2.3mm (090)

Terminal (UNIT : mm)

端子 (毫米)

Ref; 2.3mm Terminal detail
2.3mm端子参照页

S	M (8230-4472)	L-02	F (8100-1427)	L-02
M	M (8230-4562)	L-02	F (8100-1429)	L-02
L	M (8230-4552)	L-02	F (8100-1428)	L-02

2.3mm (090)

Wire seals (UNIT : mm)

电线密封栓 (毫米)

Ref; 2.3mm Wire Seals detail
2.3mm电线密封栓参照页

S (7165-0516)	J-06
M (7165-0515)	J-06
L (7165-0514)	J-06

2.3mm (090)

Dummy plugs (UNIT : mm)

盲塞 (毫米)

Ref; 2.3mm Dummy plug detail

2.3mm盲塞参照页

(7165-0193) J-07

- Dummy plugs are common to M and F.
- Dummy plugs are used to blind unused terminal holes.
- 盲塞为公端、母端共用。
- 盲塞用于堵塞不使用的端子孔。

2.3mm (090)

Housing (UNIT : mm)

接插件护套 (毫米)

Ref: Terminal part No. L-02
端子参照页

Ref: wire seal No. J-06
电线密封栓参照页

Ref: Dummy plug No. J-07
盲塞参照页

Material PBT
材质

1way

Color Black
颜色 黑

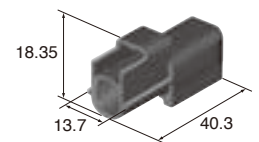

M (6181-6658)

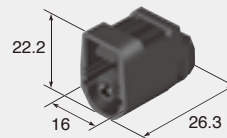

F (6189-7214)

Color Black
颜色 黑

2way

F (6189-7189)

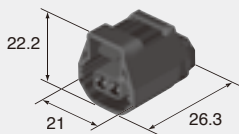

Color Black
颜色 黑

4way

F (6189-7188)

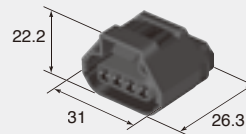

Color Black
颜色 黑

5way

F (6189-7190)

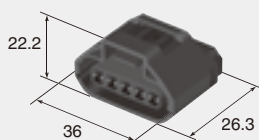

Color Black
颜色 黑

SL SERIES

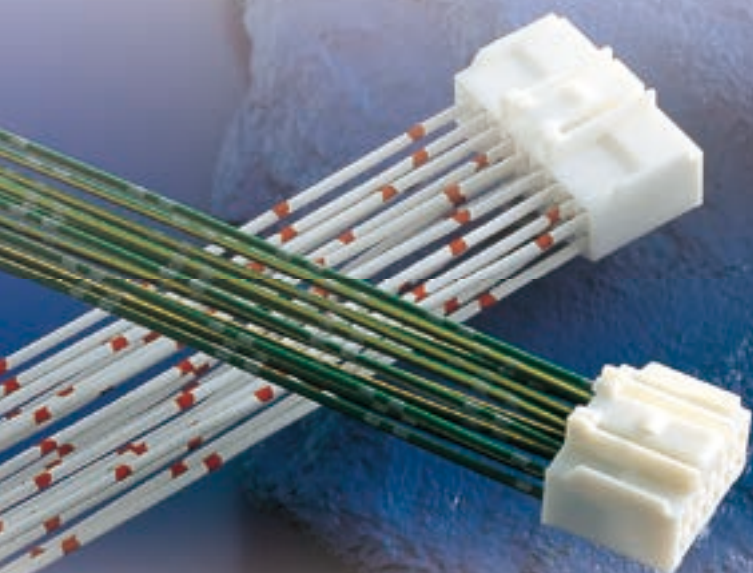

Features

The SL connector series is adopted a mechanism that detects terminal incomplete insertion by using a dedicated jig.

This series consists of 1.5mm, 2.3mm and 2.8mm types classified according to the terminal size, covering an extensive array of applications from signal circuits to low power circuits.

- These connectors can be directly secured to a bracket on the car body. In addition, an extra clip can be attached to the connector to secure it to the car body. (Note: Please contact our sales staff, if you have any questions regarding the dedicated jig.)
- RoHS/ELV Compliant

特点

SL 系列接插件采用了以专用治具检测端子半插入的构造。

按照端子尺寸划分为1.5mm·2.3mm·2.8mm 类型，从信号回路到电源回路，能广泛运用。

- 接插件可以直接固定在车体的支架上。还可以在接插件上安装用于固定到车体上的卡钉（卡子）。

注意：有关专用导通治具的详情请向敝公司销售负责人确认。

- 可对应欧盟 RoHS 和 ELV 指令

SL SERIES for STANDARD

1.5mm (060)

Structure / 构造

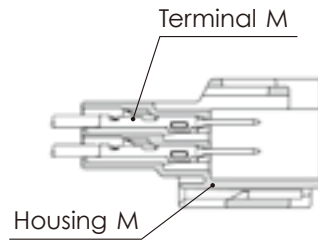
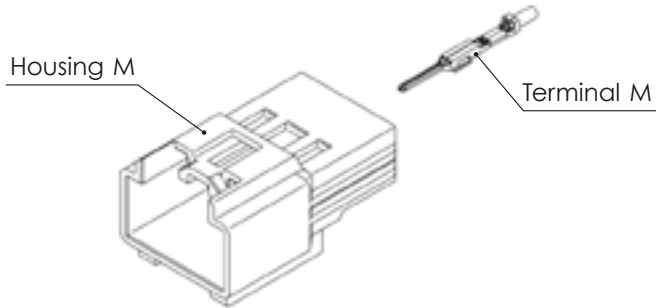

Connector M

Connector F

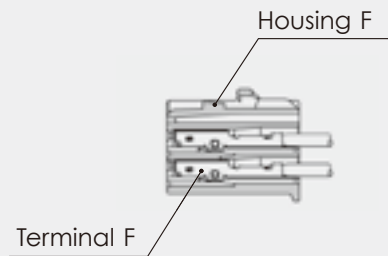
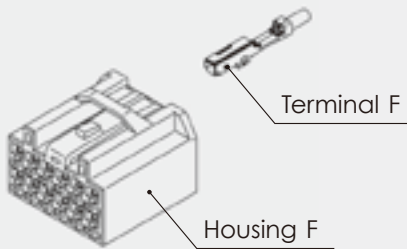

1.5mm (060)

Terminal (UNIT : mm)

端子(毫米)

Note) L size terminal can be used for 14 poled connectors with insertion cavity specified.
For details please contact our sales staff.

※ L 尺寸端子的可用接插件有限制。
务必向敝公司销售负责人问讯。

(S)

Cable size (mm²) 适用电线大小	0.3~0.5
Material 材质	Heat-resistant copper alloy
Surface treatment 表面处理	Tin-plated 镀锡

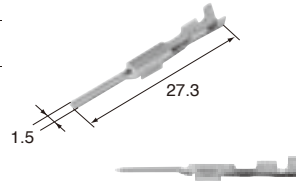
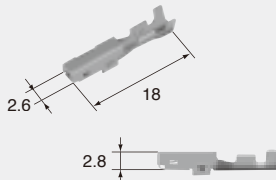
**M (8100-3382)**

Cable size (mm²) 适用电线大小	0.3~0.5
Material 材质	Heat-resistant copper alloy
Surface treatment 表面处理	Tin-plated 镀锡

F (8100-3391)**(S)**

Cable size (mm²) 适用电线大小	0.3~0.5
Material 材质	Heat-resistant copper alloy
Surface treatment 表面处理	Gold-plated 镀金

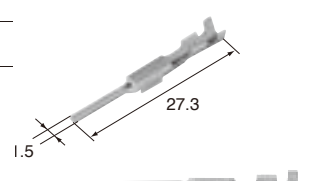
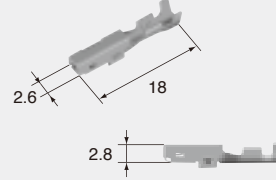
**M (8230-4883)**

Cable size (mm²) 适用电线大小	0.3~0.5
Material 材质	Heat-resistant copper alloy
Surface treatment 表面处理	Gold-plated 镀金

F (8240-0135)**(M)**

Cable size (mm²) 适用电线大小	0.75, 0.85~1.25
Material 材质	Heat-resistant copper alloy
Surface treatment 表面处理	Tin-plated 镀锡

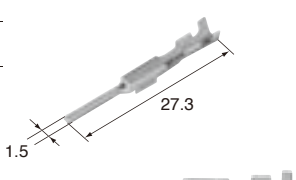
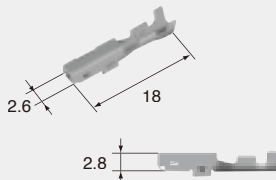
**M (8100-3383)**

Cable size (mm²) 适用电线大小	0.75, 0.85~1.25
Material 材质	Heat-resistant copper alloy
Surface treatment 表面处理	Tin-plated 镀锡

F (8100-3392)**(L)**

Cable size (mm²) 适用电线大小	2.0
Material 材质	Heat-resistant copper alloy
Surface treatment 表面处理	Tin-plated 镀锡

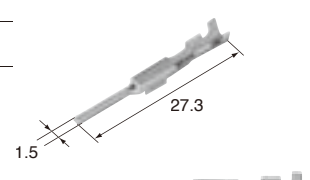
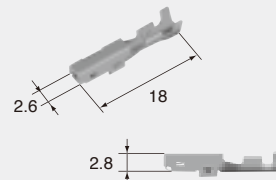
**M (8100-3384)**

Cable size (mm²) 适用电线大小	2.0
Material 材质	Heat-resistant copper alloy
Surface treatment 表面处理	Tin-plated 镀锡

F (8100-3393)**1.5mm (060)****Housing** (UNIT : mm)

接插件护套(毫米)

Ref: Terminal part No.
端子参照页

I-02

Material
材质

PBT

Note) Connector can be used together with 2mm² wire are 14 poled connectors.
For details of each product, please contact our sales staff.

※ L 尺寸端子的可用接插件有限制。
务必向敝公司销售负责人问讯。

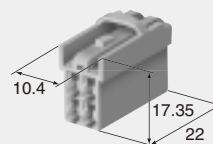
4way**F (6098-3456)**

Color
颜色

Natural
自然色

I-03

SL SERIES

12way

Color Natural
颜色 自然色

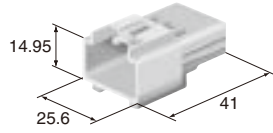

M (6098-3449)

F (6098-8482)

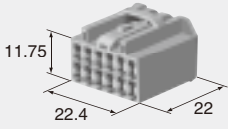

Color Natural
颜色 自然色

12way

F (6098-4876)

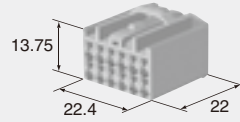

Color Natural
颜色 自然色

14way

F (6098-4877)

Note)

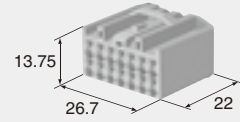

Color Natural
颜色 自然色

16way

F (6098-3453)

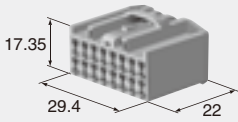

Color Natural
颜色 自然色

SL SERIES for STANDARD

2.3mm (090)

Structure / 构造

Connector F

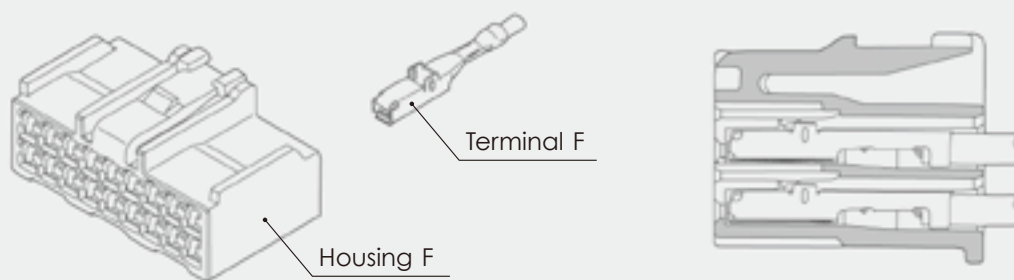

I-05

SL SERIES

2.3mm (090)

Terminal (UNIT : mm)

端子(毫米)

Ref; 2.3mm Terminal detail
2.3mm端子参照页

S	M (8230-4492)	A-10	F (8240-4882)	A-10
M	M (8230-4502)	A-10	F (8240-4892)	A-10
L	M (8230-4512)	A-10	F (8240-4942)	A-10

Regarding "Gold-plated Terminal", please refer "A-10".
镀金端子记载在A-10上

2.3mm (090)

Housing (UNIT : mm)

接插件护套(毫米)

Ref: Terminal part No. A-10
端子参照页

Material PBT
材质

2way

F (6240-5337)

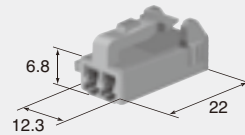

Color Natural
颜色 自然色

4way

F (6098-8478)

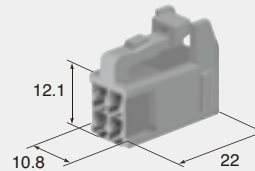

Color Natural
颜色 自然色

6way

F (6240-5339)

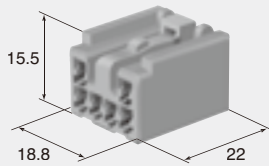

Color Natural
颜色 自然色

6way

Color Natural
颜色 自然色

Note With body fastening clamp
备注 带防转卡钉

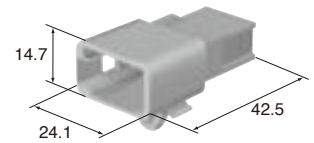
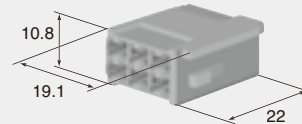

Plate thickness range for clamp :
t=0.6~2.0mm
Hole=7.2mm×12mm

M (6098-2679)

F (6098-2680)



Color Natural
颜色 自然色

12way

F (6098-1714)

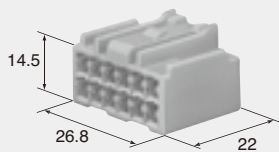

Color Natural
颜色 自然色

14way

F (6098-1747)

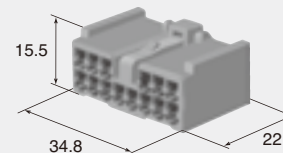

Color Natural
颜色 自然色

14way

F (6098-2101)

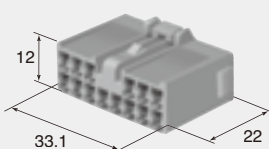

Color Natural
颜色 自然色

14way

F (6098-1774)

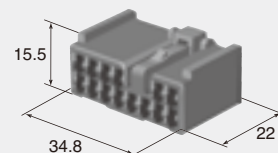

Color Black
颜色 黑

16way

Color Natural
颜色 自然色

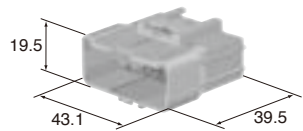

M (6098-1744) F (6098-1746)

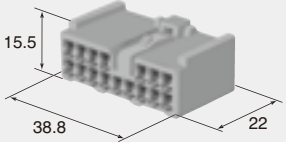

Color Natural
颜色 自然色

18way

F (6098-1627)

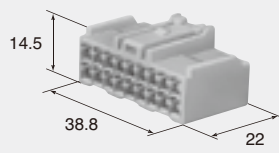

Color Natural
颜色 自然色

SL SERIES for STANDARD

2.8mm (110)

Structure / 构造

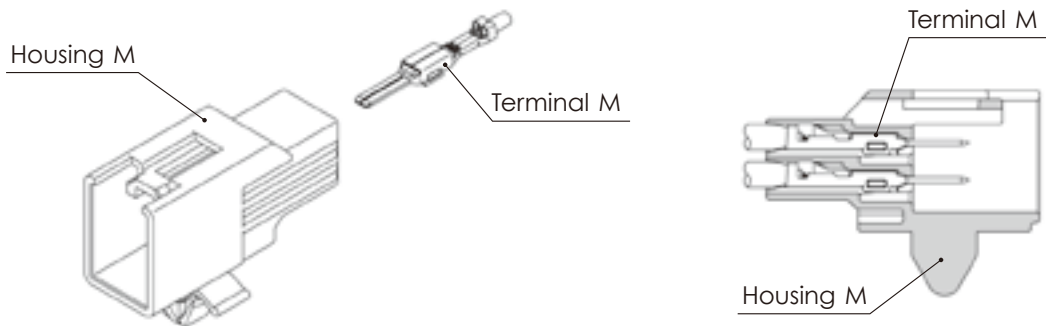

Connector M

Connector F

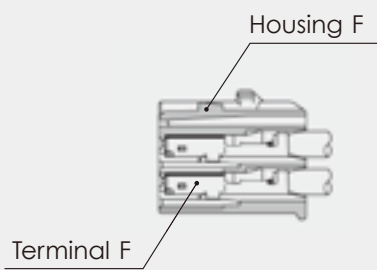
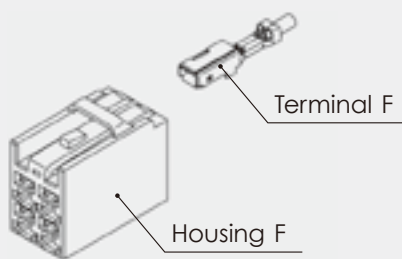

2.8mm (110)

Terminal (UNIT: mm)

端子(毫米)

(S)

Cable size (mm ²) 适用电线大小	0.3~0.5
Material 材质	Heat-resistant copper alloy
Surface treatment 表面处理	Tin-plated 镀锡

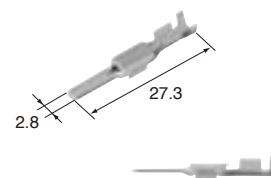

M (8100-3385)

F (8100-3394)

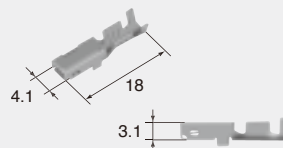

Cable size (mm ²) 适用电线大小	0.3~0.5
Material 材质	Heat-resistant copper alloy
Surface treatment 表面处理	Tin-plated 镀锡

(M)

Cable size (mm²) 适用电线大小	0.85~1.25
Material 材质	Heat-resistant copper alloy
Surface treatment 表面处理	Tin-plated 镀锡

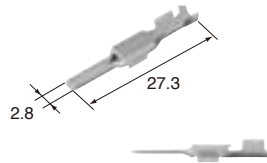
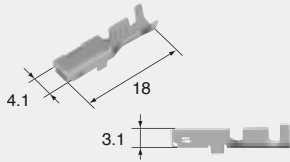
**M (8100-3386)****F (8100-3395)**

Cable size (mm²) 适用电线大小	0.85~1.25
Material 材质	Heat-resistant copper alloy
Surface treatment 表面处理	Tin-plated 镀锡

(L)

Cable size (mm²) 适用电线大小	2.0~3.0
Material 材质	Heat-resistant copper alloy
Surface treatment 表面处理	Tin-plated 镀锡

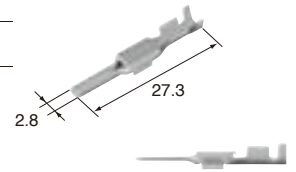
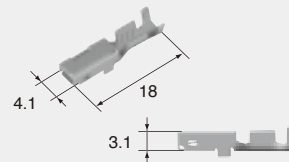
**M (8100-3387)****F (8100-3396)**

Cable size (mm²) 适用电线大小	2.0~3.0
Material 材质	Heat-resistant copper alloy
Surface treatment 表面处理	Tin-plated 镀锡

2.8mm (110)**Housing (UNIT : mm)**

接插件护套(毫米)

Ref. Terminal part No.
端子参照页

I-08

Material 材质	PBT
-----------------------	-----

4way

Color 颜色	Natural 自然色
Note 备注	With body fastening clamp 带防转卡钉

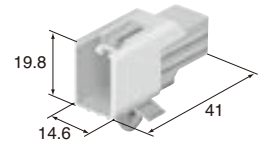
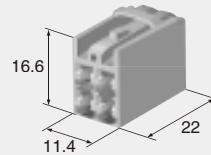

Plate thickness range for clamp:
t=0.6~2.0mm
Hole=7.2mm×10.2mm

M (6098-3452)**F (6098-8480)**

Color 颜色	Natural 自然色
--------------------	----------------

I-09

SL SERIES

1.5mm, 2.8mm (060, 110)

Housing (UNIT : mm)

Ref: Terminal part No.	[1.5mm]	I-02
端子参照页	[2.8mm]	I-08

Material	PBT
材质	

No. of way/ () corresponds to 1.5mm, 2.8mm, in order from left to right.
Note) Connector can be used together with 2mm² wire are 14 poled connectors.
For details of each product, please contact our sales staff.

极数 / () 内显示: 1.5mm 极数、2.8mm 极数
※ L 尺寸端子的可用接插件有限制。
务必向敝公司销售负责人问讯。

SL SERIES for HYBRID

I-10

14way (10+4)

Color	Natural
颜色	自然色

Note)

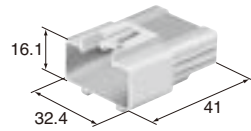

M (6098-3450)

F (6098-3458)

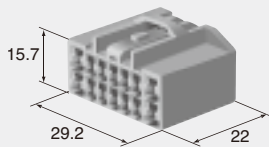

Note)

Color	Natural
颜色	自然色

SL SEALED SERIES



Features

The SL sealed connector series is adopted a mechanism that detects terminal incomplete insertion by using a dedicated jig.

This series consists of 1.5mm, 2.3mm and 8.0mm types classified according to the terminal size, covering an extensive array of applications from signal circuits to low power circuits.

- These connectors can be directly secured to a bracket on the car body. In addition, an extra clip can be attached to the connector to secure it to the car body. (Note: Please contact our sales staff, if you have any questions regarding the dedicated jig.)
- RoHS/ELV Compliant

特点

SL 防水系列接插件采用了以专用治具检测端子半插入的构造。

按照端子尺寸划分为1.5mm·2.3mm·8.0mm 类型，从信号回路到电源回路，能广泛运用。

- 接插件可以直接固定在车体的支架上。另外在接插件上可安装为固定到车体的卡钉（卡子）
- 注意：有关专用导通治具的详情请向敝公司销售负责人确认。
- 可对应欧盟 RoHS 和 ELV 指令

SL SEALED SERIES for STANDARD

1.5mm (060)

Structure / 构造

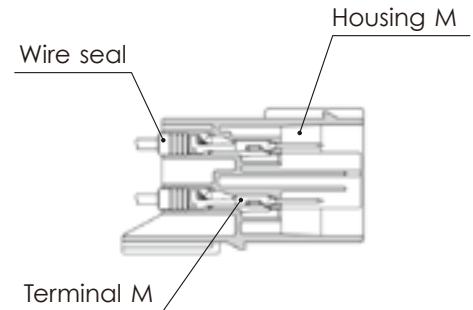
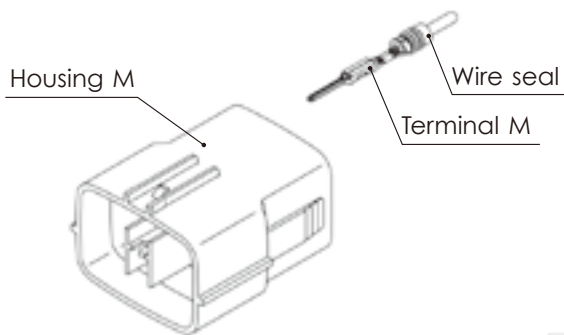

Connector M

Connector F

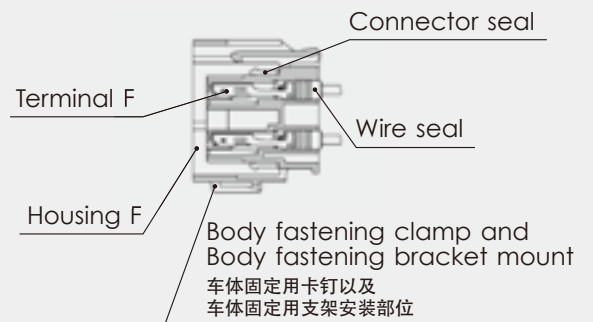
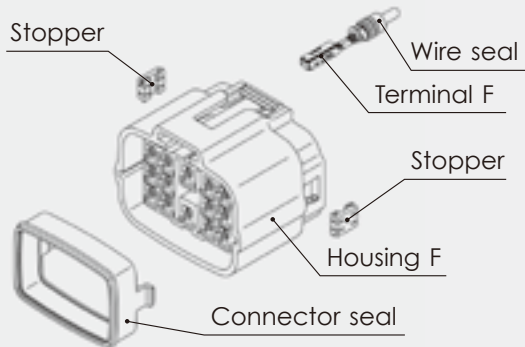

1.5mm (060)

Terminal (UNIT : mm)

端子(毫米)

※ For terminal selection, please contact our sales staff.

※ 选定端子时, 请一定向敝公司销售负责人问讯。

(S)

Cable size (mm²) 适用电线大小	0.3~0.5
Material 材质	Heat-resistant copper alloy
Surface treatment 表面处理	Tin-plated 镀锡

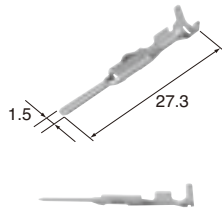
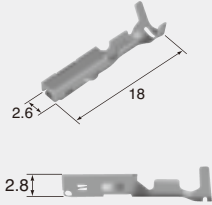
**M (8100-3388)**

Cable size (mm²) 适用电线大小	0.3~0.5
Material 材质	Heat-resistant copper alloy
Surface treatment 表面处理	Tin-plated 镀锡

F (8100-3397)**(S)****Au**

Cable size (mm²) 适用电线大小	0.3~0.5
Material 材质	Heat-resistant copper alloy
Surface treatment 表面处理	Gold-plated 镀金

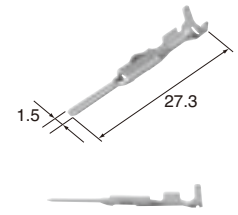
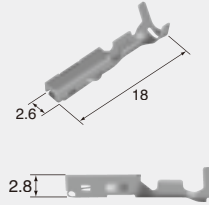
**M (8100-3504)**

Cable size (mm²) 适用电线大小	0.3~0.5
Material 材质	Heat-resistant copper alloy
Surface treatment 表面处理	Gold-plated 镀金

F (8100-3402)**(M)**

Cable size (mm²) 适用电线大小	0.75~0.85
Material 材质	Heat-resistant copper alloy
Surface treatment 表面处理	Tin-plated 镀锡

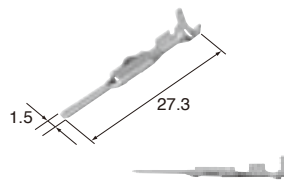
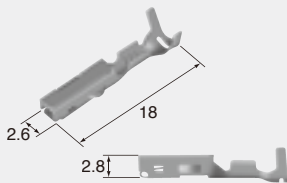
**M (8100-3389)**

Cable size (mm²) 适用电线大小	0.75~0.85
Material 材质	Heat-resistant copper alloy
Surface treatment 表面处理	Tin-plated 镀锡

F (8100-3398)**(M)****Au****M (8100-3403)**

Cable size (mm²) 适用电线大小	0.75~0.85
Material 材质	Heat-resistant copper alloy
Surface treatment 表面处理	Gold-plated 镀金

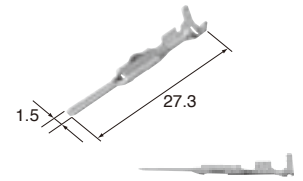
**J-03**

SL SEALED SERIES

(L)

Cable size (mm²) 适用电线大小	1.25~2.0
Material 材质	Heat-resistant copper alloy
Surface treatment 表面处理	Tin-plated 镀锡

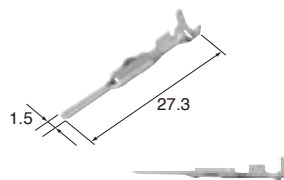
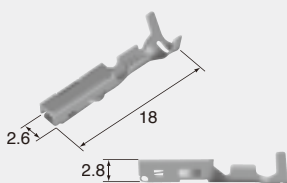
**M (8100-3390)**

Cable size (mm²) 适用电线大小	1.25~2.0
Material 材质	Heat-resistant copper alloy
Surface treatment 表面处理	Tin-plated 镀锡

F (8100-3399)

1.5mm (060)

Wire seals (UNIT : mm)

电线密封栓(毫米)

Ref; 1.5mm Terminal detail
1.5mm端子参照页

S (7165-0516) J-07

M (7165-0515) J-07

L (7165-0514) J-07

1.5mm (060)

Dummy plugs (UNIT : mm)

盲塞(毫米)

Ref; 1.5mm Dummy plug detail
1.5mm盲塞参照页

(7161-9787) B-15

(7165-0193) J-07

J-04

1.5mm (060)

Housing (UNIT : mm)

接插件护套(毫米)

Ref: Terminal part No. J-02
端子参照页

Ref: wire seal No. J-06
电线密封栓参照页

Ref: Dummy plug No. B-15
盲塞参照页

Material PBT
材质

2way

Color Black
颜色 黑

Note J-11
备注 Clamp:TYPE2

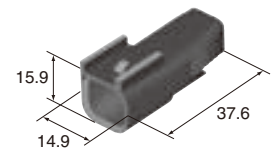

M (6181-6614)

F (6189-1076)

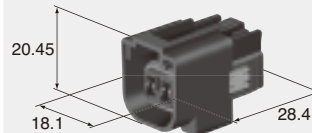

Color Black
颜色 黑

2way

Color Dark Gray
颜色 深灰

Note J-11
备注 Clamp:TYPE2

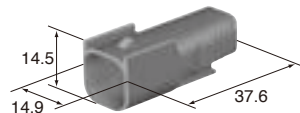

M (6181-6509)

F (6189-1073)

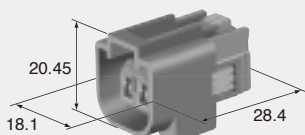

Color Dark Gray
颜色 深灰

2way

Color Black
颜色 黑

Note J-11
备注 Clamp:TYPE2

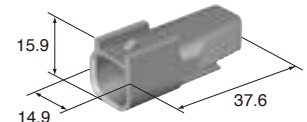

M (6181-6492)

F (6189-1115)

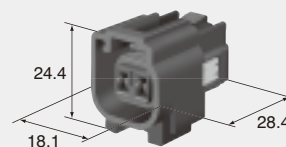

Color Black
颜色 黑

Note J-11
备注 Clamp:TYPE1

2way

F (6189-1147)

Color 颜色 Black 黑

2way

F (6189-1144)

Color 颜色 Black 黑

2way

F (6189-1150)

Color 颜色 Dark Gray 深灰

2way

F (6189-1149)

Color 颜色 Dark Gray 深灰

3way

F (6189-7115)

Color 颜色 Black 黑

14way

Color 颜色 Dark Gray 深灰

M (6181-0629)

F (6189-7262)

Color 颜色 Dark Gray 深灰

Note 备注 J-11
Clamp:TYPE1

J-05
SL SEALED SERIES

SL SEALED SERIES for STANDARD

2.3mm (090)

Structure / 构造

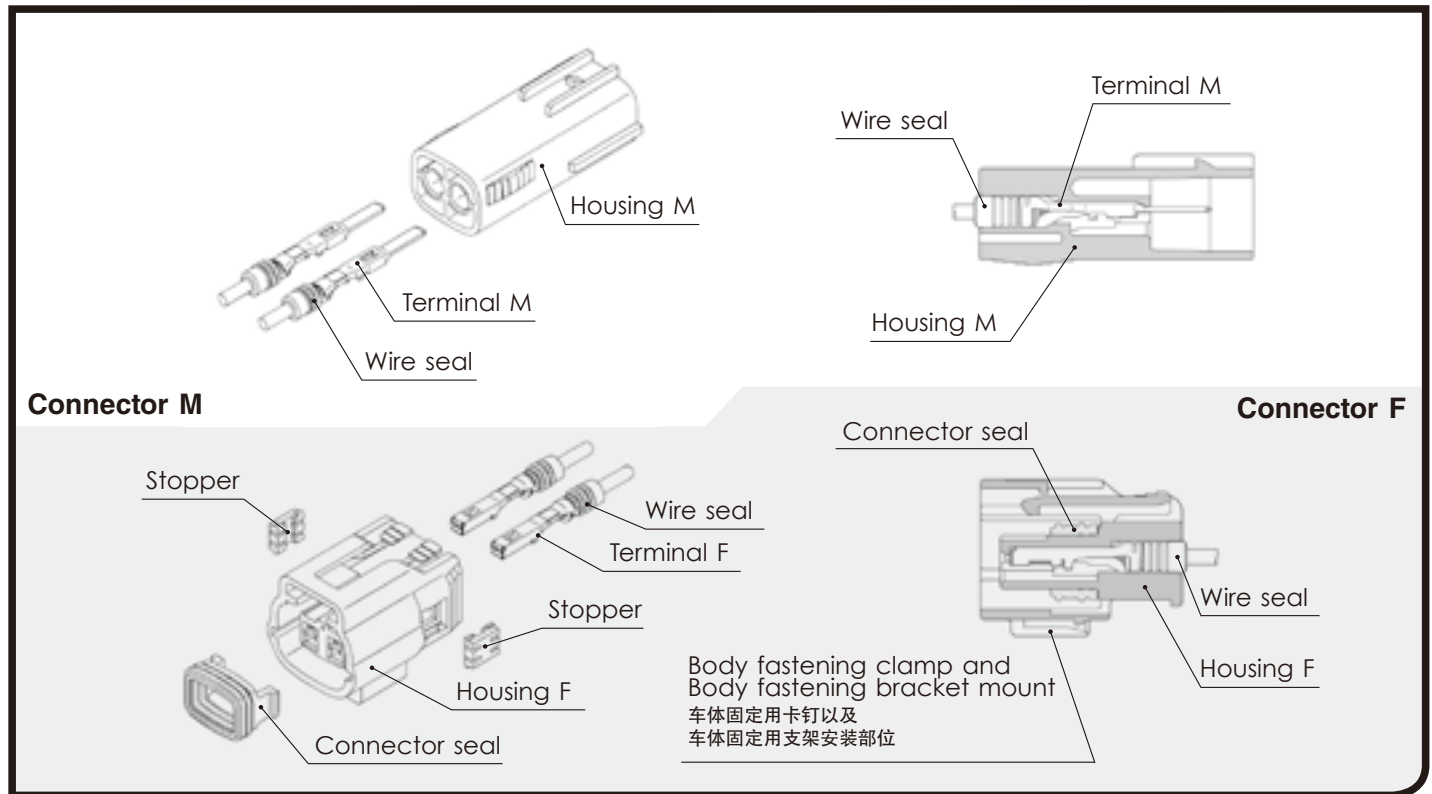

J-06

2.3mm (090)

Terminal (UNIT : mm)

端子 (毫米)

Ref; 2.3mm Terminal detail
2.3mm端子参照页

S (8230-4472)	L-02	F (8100-1427)	L-02
M (8230-4562)	L-02	F (8100-1429)	L-02
L (8230-4552)	L-02	F (8100-1428)	L-02

Regarding "Gold-plated Terminal", please refer "L-02".
镀金端子记载在L-02上

2.3mm (090)

Wire seals (UNIT : mm)

电线密封栓 (毫米)

The wire seals are common to M and F.
电线密封栓为公端、母端共用。

(S)**(7165-0516)**

Cable overall diameter(mm) Over than 1.4 mm below 1.6 mm
带绝缘层外径 超过1.4mm在1.6mm以下

Material Silicon
材质 硅

Color Black
颜色 黑

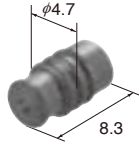
**(M)****(7165-0515)**

Cable overall diameter(mm) Over than 1.6 mm below 2.4 mm
带绝缘层外径 超过1.6mm在2.4mm以下

Material Silicon
材质 硅

Color Gray
颜色 灰

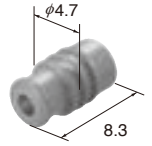
**(L)****(7165-0514)**

Cable overall diameter(mm) Over than 2.4 mm below 2.7 mm
带绝缘层外径 超过2.4mm在2.7mm以下

Material Silicon
材质 硅

Color Dark Green
颜色 墨绿

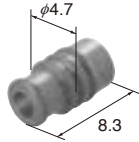

2.3mm (090)

Dummy plugs (UNIT : mm)

盲塞 (毫米)

Ref; 2.3mm Dummy plug detail
2.3mm盲塞参照页

(7161-9787) B-15

- Dummy plugs are common to M and F.
- Dummy plugs are used to blind unused terminal holes.
- 盲塞为公端、母端共用。
- 盲塞用于堵塞不使用的端子孔。

2.3mm (090)

Housing (UNIT : mm)

接插件护套 (毫米)

Ref: Terminal part No. L-02
端子参照页

Ref: wire seal No. J-06
电线密封栓参照页

Ref: Dummy plug No. B-11 J-07
盲塞参照页

Material PBT
材质

(7165-0193)

Material Silicon
材质 硅
Color Green
颜色 绿

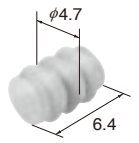

1way

Color Dark Gray
颜色 深灰

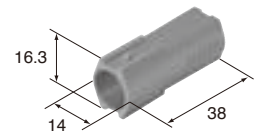
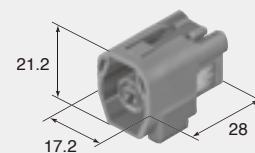
**M (6181-0436)****F (6189-0639)**

Color Dark Gray
颜色 深灰
Note J-11
备注 Clamp:TYPE1

2way

Color Dark Gray
颜色 深灰

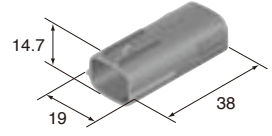

M (6181-0437)

F (6189-0640)

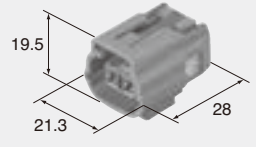

Color Dark Gray
颜色 深灰
Note J-11
备注 Clamp:TYPE1

3way

Color Dark Gray
颜色 深灰

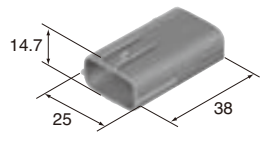

M (6181-0438)

F (6189-7784)

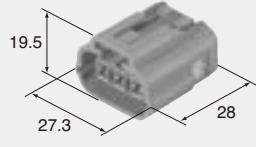

Color Dark Gray
颜色 深灰
Note J-11
备注 Clamp:TYPE1

4way

Color Dark Gray
颜色 深灰

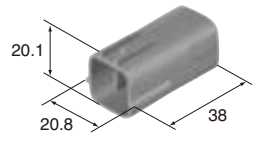

M (6181-0439)

F (6189-0643)

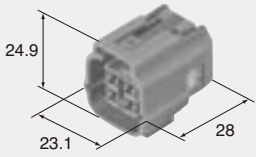

Color Dark Gray
颜色 深灰
Note J-11
备注 Clamp:TYPE1

6way

Color Dark Gray
颜色 深灰

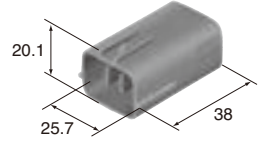

M (6181-0440)

F (6189-0648)

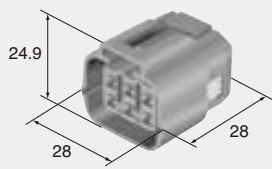

Color Dark Gray
颜色 深灰
Note J-11
备注 Clamp:TYPE1

SL SEALED SERIES for STANDARD

8.0mm (312)

Structure / 构造

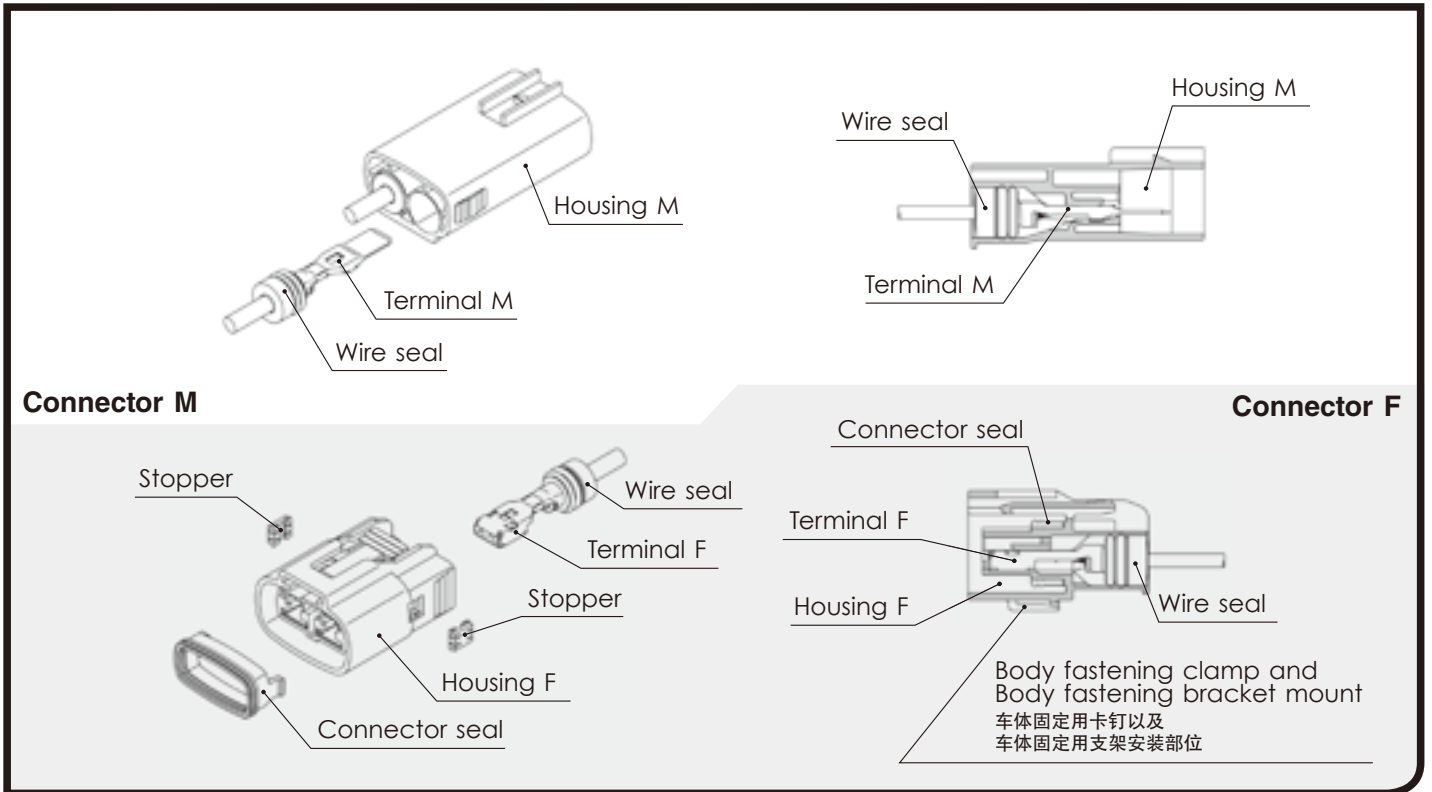

J-09

SL SEALED SERIES

8.0mm (312)

Terminal (UNIT : mm)

端子(毫米)

※ For terminal selection, please contact our sales staff.

※ 选定端子时, 请一定向敝公司销售负责人问讯。

(M)

Cable size (mm²) 适用电线大小	2.0~3.0
Material 材质	Brass 黄铜
Surface treatment 表面处理	Tin-plated 镀锡

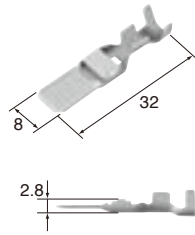
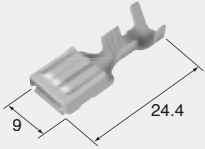
**M (8100-3259)**

Cable size (mm²) 适用电线大小	2.0~3.0
Material 材质	Heat-resistant copper alloy
Surface treatment 表面处理	Tin-plated 镀锡

F (8100-3257)**(L)**

Cable size (mm²) 适用电线大小	5.0~8.0
Material 材质	Brass 黄铜
Surface treatment 表面处理	Tin-plated 镀锡

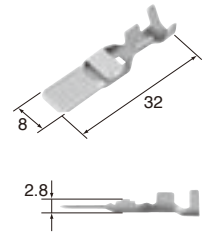
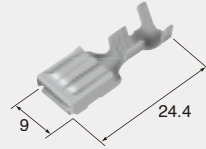
**M (8100-3260)**

Cable size (mm²) 适用电线大小	5.0~8.0
Material 材质	Heat-resistant copper alloy
Surface treatment 表面处理	Tin-plated 镀锡

F (8100-3258)**8.0mm (312)****Wire seals (UNIT : mm)**

电线密封栓 (毫米)

Ref: 8.0mm Wire Seals detail

8.0mm电线密封栓参照页

SS (7165-0683) B-24

S (7165-0400) B-24

M (7165-0392) B-24

L (7165-0393) B-24

The wire seals are common to M and F.

电线密封栓为公端、母端共用。

8.0mm (312)**Dummy plugs (UNIT : mm)**

盲塞 (毫米)

Ref: 8.0mm Dummy plug detail

8.0mm盲塞参照页

(7165-0180) B-25

- Dummy plugs are common to M and F.
- Dummy plugs are used to blind unused terminal holes.

- 盲塞为公端、母端共用。
- 盲塞用于堵塞不使用的端子孔。

8.0mm (312)**Housing (UNIT : mm)**

接插件护套 (毫米)

Ref: Terminal part No. J-09
端子参照页

Ref: wire seal No. B-24
电线密封栓参照页

Ref: Dummy plug No. B-25
盲塞参照页

Material PBT
材质

2way

Color 颜色	Dark Gray 深灰
--------------------	-----------------

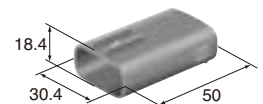
**M (6181-0613)**

Color 颜色	Dark Gray 深灰
Note 备注	J-11 Clamp:TYPE1

F (6189-0915)

SL SEALED SERIES COMMON USE PARTS

Body fastening clamp (mm)

车体固定用卡钉(毫米)

1.5mm standard type, 2.3mm standard type and 8.0mm standard type connectors, the clamp can be installed.

※ The detail dimensions for the mounting portion are specified in drawing

根据需要, 可以在1.5mm 标准 • 2.3mm 标准 • 8.0mm 标准的接插件上, 安装用于固定在车体上的卡钉。

※安装部位的详细尺寸另行图纸规定。

Type 1

(6810-1584)

Material 材质	PBT
Color 颜色	Brown 棕
hole size 孔径	7.2×10.2
Plate thickness range for clamp 卡钉适合板厚	t=0.7~2.0

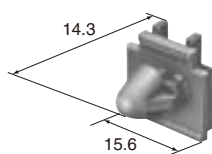

Type 2

(6810-4982)

Material 材质	PA66
Color 颜色	Natural 自然色
Plate thickness range for clamp 卡钉适合板厚	t=2.0

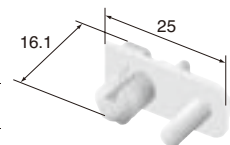

DL SERIES



Features

The DL connector series has a mechanism that detects when terminals are not inserted completely.

This series consists of 0.64mm, 1.0mm and 2.3mm types classified according to the terminal size, supporting use in a variety of control circuits and low power circuits.

- The connector mechanism only allows the retainer to be set when the terminal is completely inserted.
- These connectors can be directly secured to a bracket on the car body.
- RoHS/ELV Compliant

特点

DL 系列接插件具有检验端子插入不足的构造。按照端子尺寸划分为0.64mm · 1.0mm · 2.3mm 类型，可以应用于各种控制回路与低功率回路。

- 具有当端子在半插入状态时，锁片无法安装到位的检验功能。
- 接插件可以直接固定在车体的支架上。
- 可对应欧盟 RoHS 和 ELV 指令

DL SERIES for STANDARD

0.64mm (025)

Structure / 构造

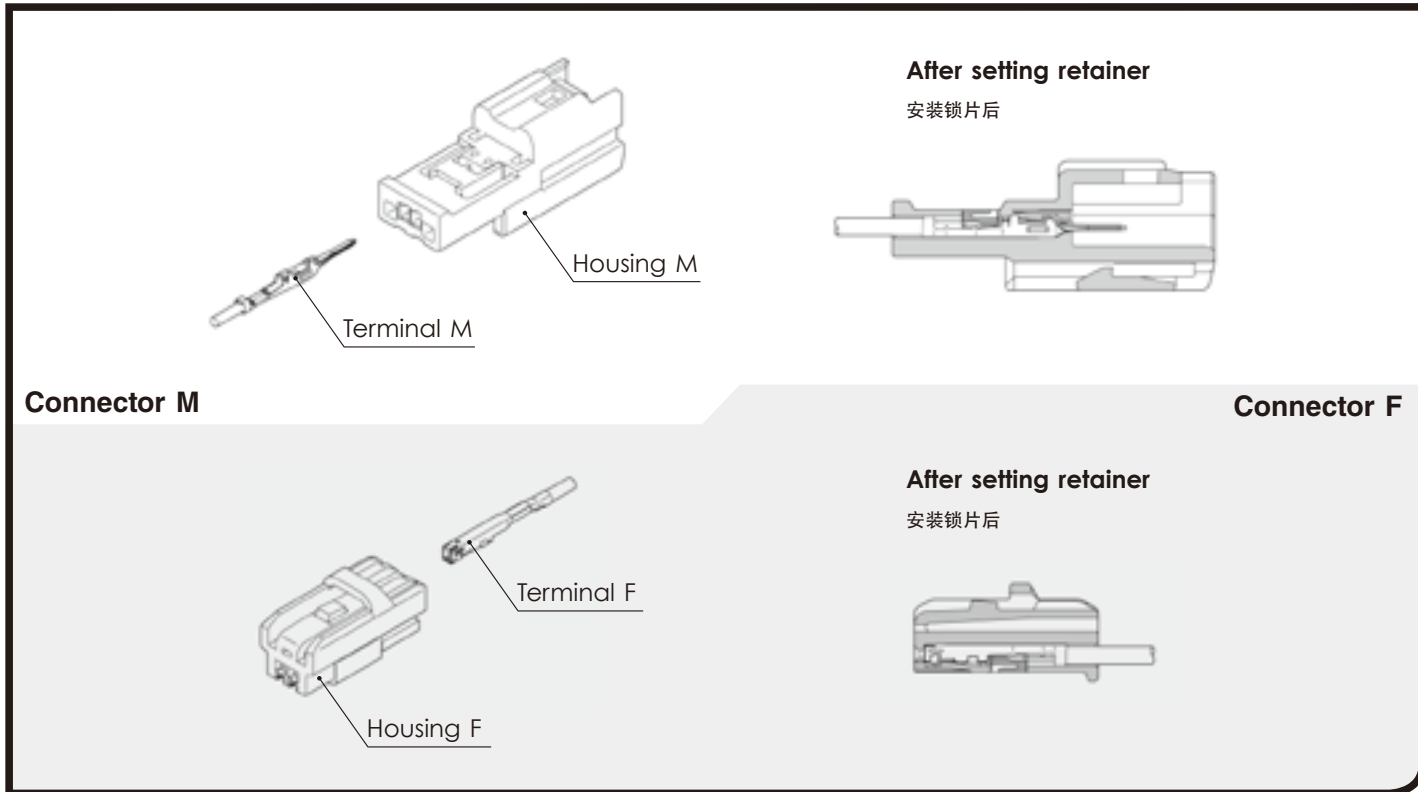

K-02

0.64mm (025)

Terminal (UNIT : mm)
端子 (毫米)

Ref: 0.64mm Terminal detail
0.64mm端子参照页

S	M (8100-4028)	C-02	F (8100-4029)	C-02
M	M (8100-4027)	C-02	F (8100-4030)	C-02

0.64mm (025)

Housing (UNIT : mm)
接插件护套 (毫米)

Ref: Terminal part No. C-02
端子参照页

Material 材质	PBT
-----------------------	-----

2way

Color Natural
颜色 自然色

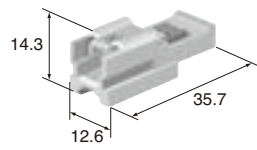

M (6098-4569)

Color Natural
颜色 自然色

Note With body fastening clamp.
备注 带防转卡钉

Plate thickness range for clamp;
 $t=0.6\sim 2.0\text{mm}$
Hole= $7.2\text{mm}\times 10.2\text{mm}$

M (6098-4567)

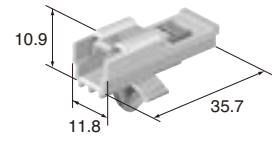

F (6098-4565)

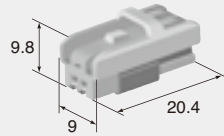

Color Natural
颜色 自然色

K-03

DL SERIES

DL SERIES for STANDARD

1.0mm (040)

This connector has a terminal pitch of 2.5 mm.
端子间间距2.5mm的接插件

Structure / 构造

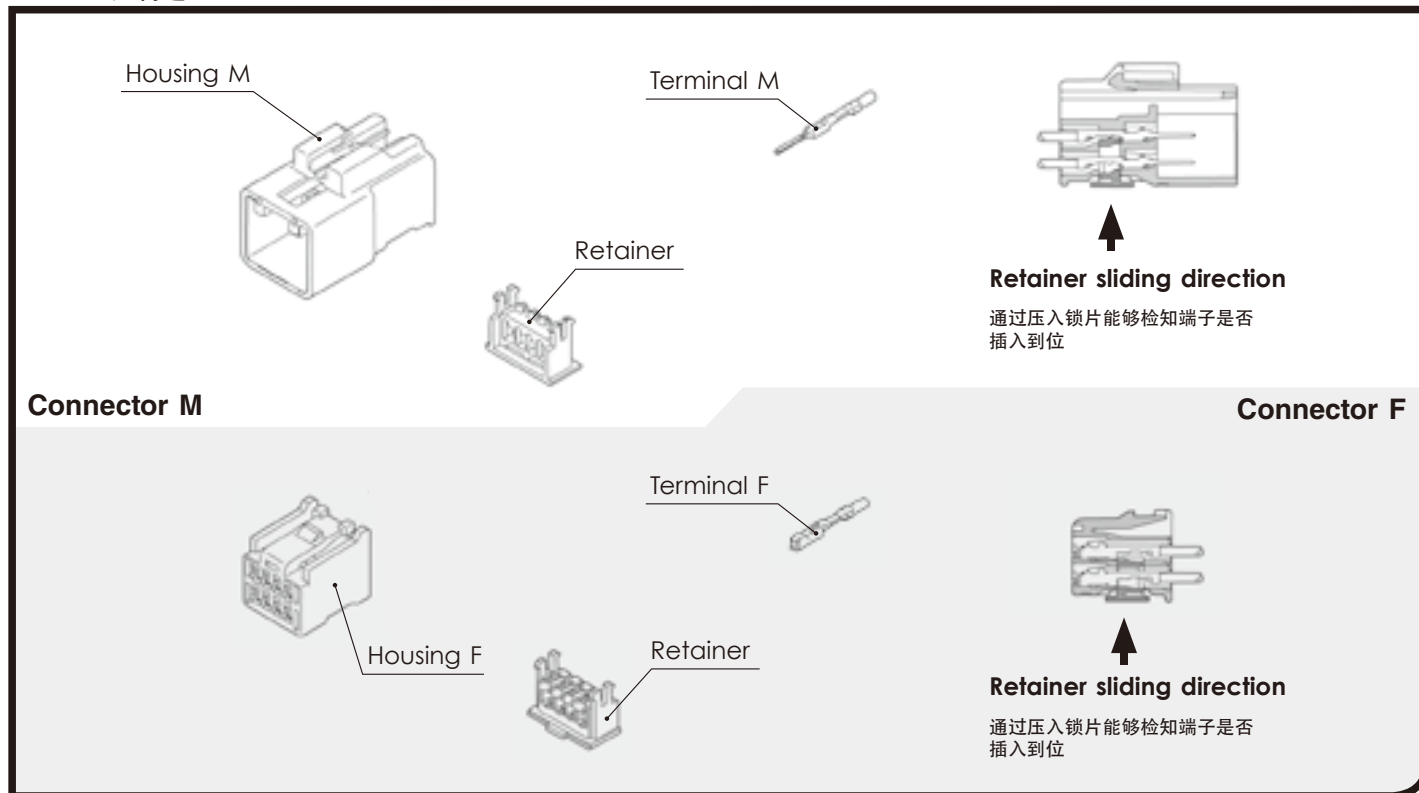

K-04

1.0mm (040)

Terminal (UNIT : mm)

端子(毫米)

※ For terminal selection, please contact our sales staff.
Note) M size terminal can be used connector with insertion cavity specified. For details please contact our sales staff.

※ Surface treatment of gold-plated is available to meet your needs.

Thick size is for the time being now.

※ 选定端子时, 请一定向敝公司销售负责人问讯。

注) M 尺寸端子的可用接插件有限制。

请一定向敝公司销售负责人问讯。

※ 有关镀金式样, 根据需要可以定制。

此外、厚度仅供临时参考。

(S)

Cable size (mm²) 适用电线大小	0.3~0.5
Material 材质	Brass 黄铜
Surface treatment 表面处理	Tin-plated 镀锡

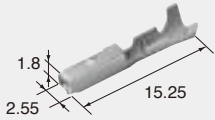
**M (8100-2512)**

Cable size (mm²) 适用电线大小	0.3~0.5
Material 材质	Heat-resistant copper alloy
Surface treatment 表面处理	Tin-plated 镀锡

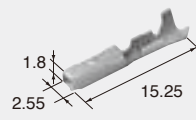
F (8100-1710)**(S)****Au****F (8240-0300)**

Cable size (mm²) 适用电线大小	0.3~0.5
Material 材质	Heat-resistant copper alloy
Surface treatment 表面处理	Gold-plated 镀金

(M)

Cable size (mm²) 适用电线大小	0.75, 0.85~1.25
Material 材质	Brass 黄铜
Surface treatment 表面处理	Tin-plated 镀锡

Note)

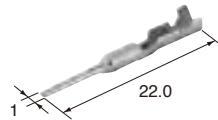
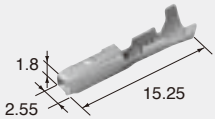
**M (8100-2513)**

Cable size (mm²) 适用电线大小	0.75, 0.85~1.25
Material 材质	Heat-resistant copper alloy
Surface treatment 表面处理	Tin-plated 镀锡

Note)

F (8100-2514)**1.0mm (040)****Housing** (UNIT : mm)

接插件护套(毫米)

Ref: Terminal part No.
端子参照页

K-04

Material
材质

PBT

Note) M size terminal can be used connector with insertion cavity specified. For details please contact our sales staff.

注) M尺寸端子的可用接插件有限制。

4way

Color
颜色

Natural
自然色

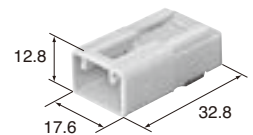
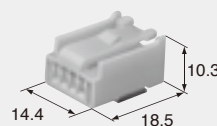
**M (6098-2158)****F (6098-2013)**

Color
颜色

Natural
自然色

K-05

DL SERIES

8way

Color Natural
颜色 自然色

Note)

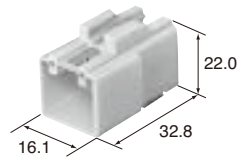

M (6098-2206) F (6098-2208)

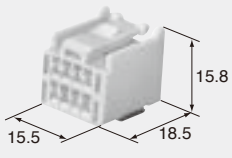

Note)

Color Natural
颜色 自然色

20way

F (6098-1626)

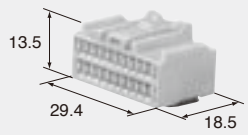

Color Natural
颜色 自然色

12way

F (6098-2289)

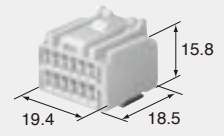

Color Natural
颜色 自然色

16way

F (6098-1624)

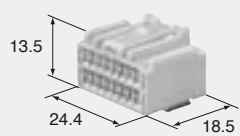

Color Natural
颜色 自然色

DL SERIES for STANDARD

2.3mm (090)

Structure / 构造

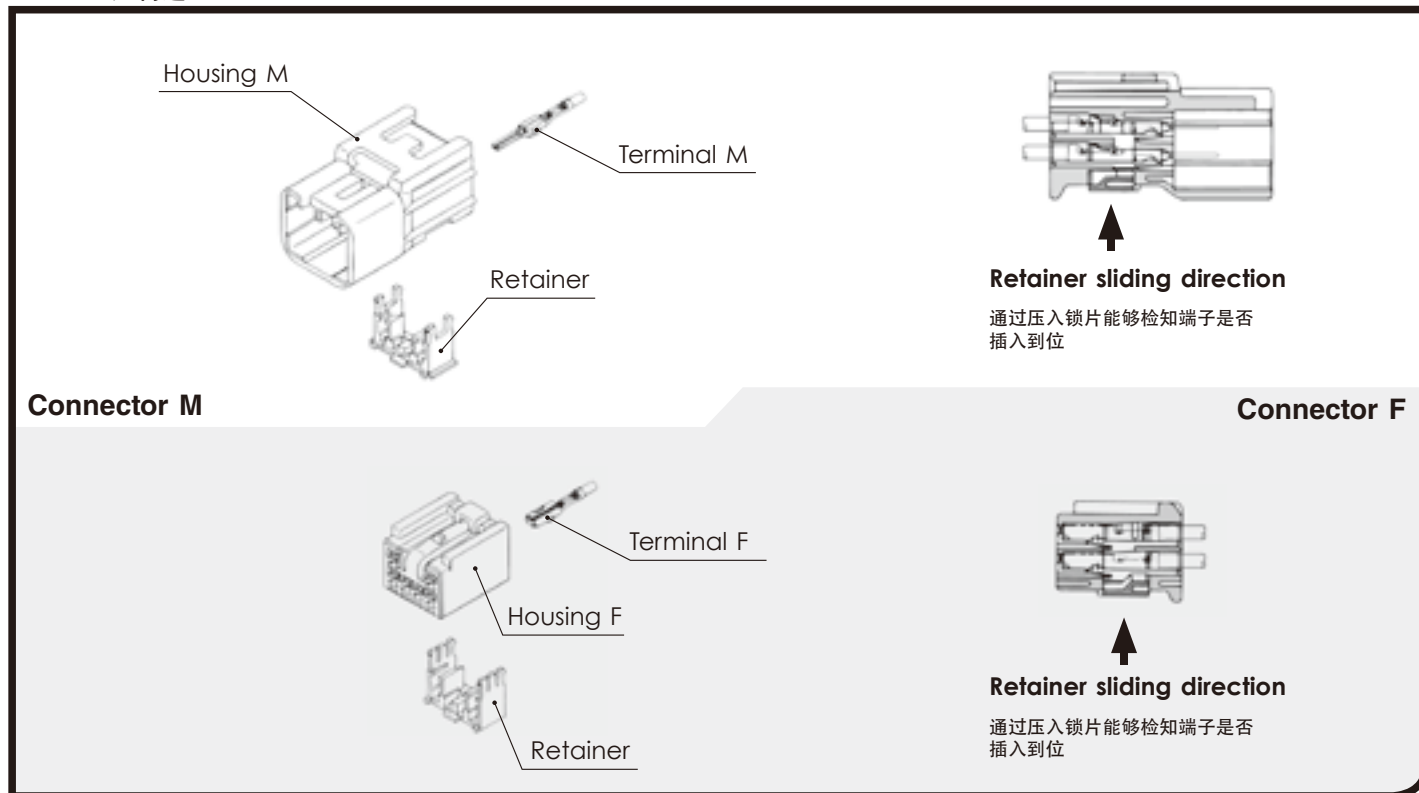

K-07

DL SERIES

2.3mm (090)

Terminal (UNIT : mm)

端子(毫米)

Ref: 2.3mm Terminal detail
2.3mm端子参照页

S M(8230-4492) A-10 **F**(8240-4882) A-10

M M(8230-4502) A-10 **F**(8240-4892) A-10

L M(8230-4512) A-10 **F**(8240-4942) A-10

Regarding "Gold-plated Terminal", please refer "A-10".
镀金端子记载在A-10上

2.3mm (090)

Housing (UNIT : mm)

接插件护套(毫米)

Ref: Terminal part No. A-10
端子参照页

Material Low water absorption
材质 Nylon

K-08

2way

Color 颜色 Natural 自然色

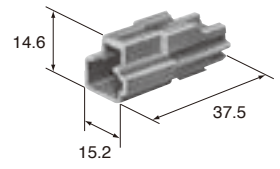

M (6249-1248)

F (6249-1251)

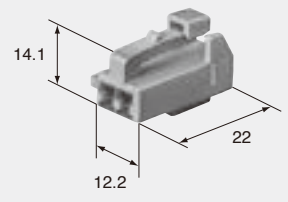

Color 颜色 Natural 自然色

4way

Color 颜色 Natural 自然色

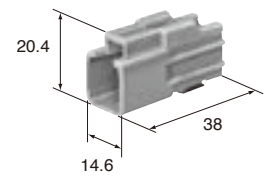

M (6249-1249)

F (6249-1252)

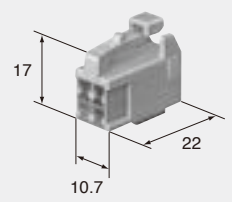

Color 颜色 Natural 自然色

6way

Color 颜色 Natural 自然色

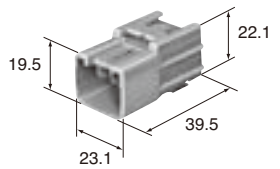

M (6249-1250)

F (6249-1253)

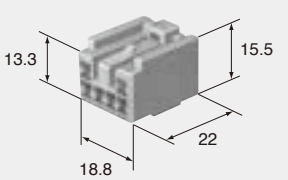

Color 颜色 Natural 自然色

10way

F (6248-5311)

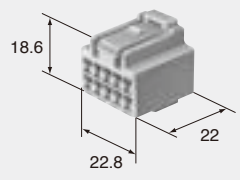

Color 颜色 Natural 自然色

14way

Color 颜色 Natural 自然色

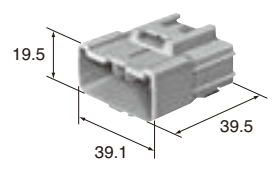

M (6249-1265)

F (6248-5309)

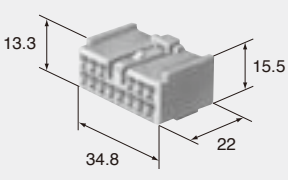

Color 颜色 Natural 自然色

16way

Color 颜色 Natural 自然色

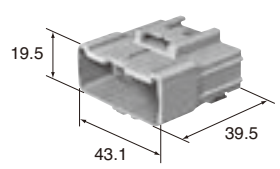

M (6249-1266)

F (6248-5310)

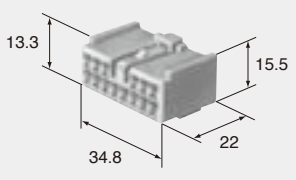

Color 颜色 Natural 自然色

DL SEALED SERIES

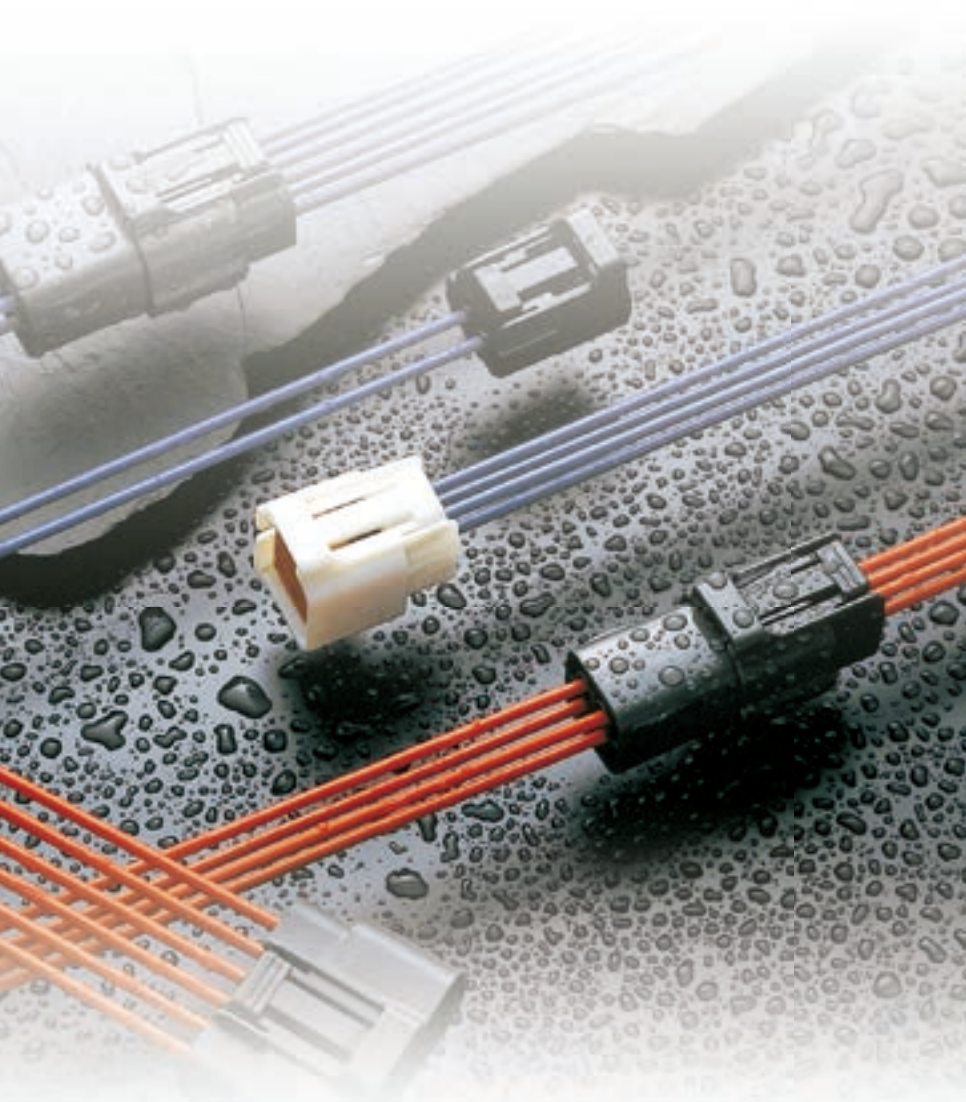

Features

The DL sealed connector series has a mechanism that detects when terminals are not inserted completely.

The series consists of 2.3mm type covering an extensive array of applications from signal circuits to power circuits.

- The connector mechanism only allows the retainer to be set when the terminal is completely inserted.
- These connectors can be directly secured to a bracket on the car body.
- In addition, an extra clip can be attached to the connector to secure it to the car body.
- RoHS/ELV Compliant

特点

DL 防水系列接插件具有检验端子插入不足的功能。

尺寸为2.3mm 的端子可广泛应用于信号回路或低功率回路等。

- 具有当端子在半插入状态时，锁片无法安装到正确位置的检知功能。
- 接插件可以直接固定在车体的支架上。
- 另外在接插件上可安装为固定到车体的卡钉（卡子）。
- 可对应欧盟 RoHS 和 ELV 指令

DL SEALED SERIES for STANDARD

2.3mm (090)

Structure / 构造

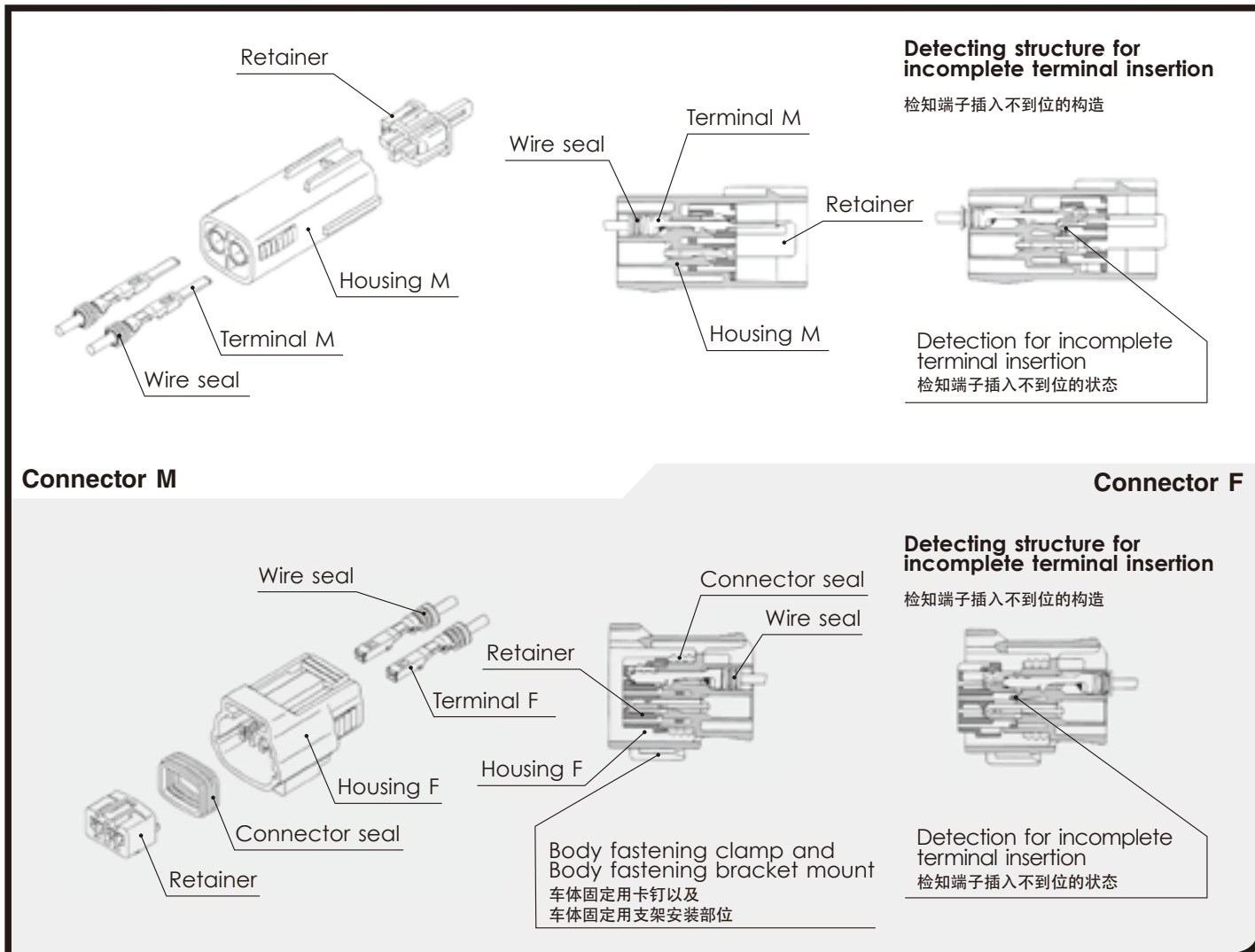

2.3mm (090)

Terminal (UNIT : mm)

端子(毫米)

※ For terminal selection, please contact our sales staff.

※ 选定端子时, 请一定向敝公司销售负责人问讯。

(S)

Cable size (mm²) 适用电线大小	0.3~0.5
Material 材质	Brass 黄铜
Surface treatment 表面处理	Tin-plated 镀锡

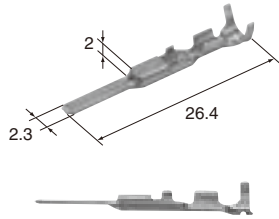
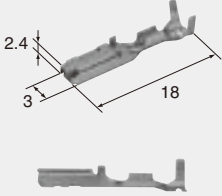
**M (8230-4472)****F (8100-1427)**

Cable size (mm²) 适用电线大小	0.3~0.5
Material 材质	Heat-resistant copper alloy
Surface treatment 表面处理	Tin-plated 镀锡

(S)**Au**

Cable size (mm²) 适用电线大小	0.3~0.5
Material 材质	Brass 黄铜
Surface treatment 表面处理	Gold-plated 镀金

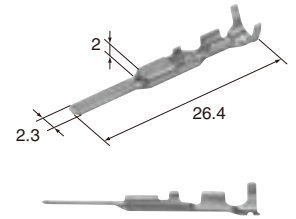
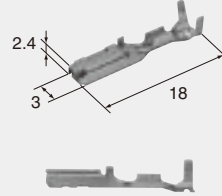
**M (1500-0159)****F (8100-1458)**

Cable size (mm²) 适用电线大小	0.3~0.5
Material 材质	Heat-resistant copper alloy
Surface treatment 表面处理	Gold-plated 镀金

(M)

Cable size (mm²) 适用电线大小	0.75~0.85
Material 材质	Brass 黄铜
Surface treatment 表面处理	Tin-plated 镀锡

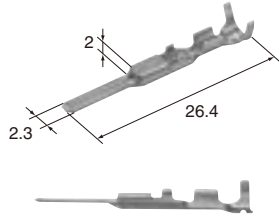
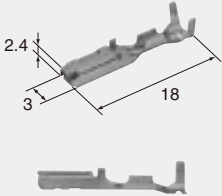
**M (8230-4562)****F (8100-1429)**

Cable size (mm²) 适用电线大小	0.75~0.85
Material 材质	Heat-resistant copper alloy
Surface treatment 表面处理	Tin-plated 镀锡

(M)**Au**

Cable size (mm²) 适用电线大小	0.75~0.85
Material 材质	Brass 黄铜
Surface treatment 表面处理	Gold-plated 镀金

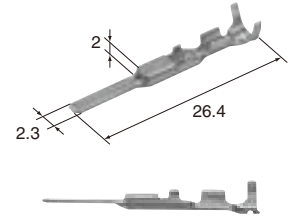
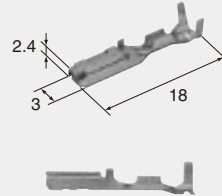
**M (1500-0169)****F (8100-1460)**

Cable size (mm²) 适用电线大小	0.75~0.85
Material 材质	Heat-resistant copper alloy
Surface treatment 表面处理	Gold-plated 镀金

(L)

Cable size (mm²) 适用电线大小	1.25~2.0
Material 材质	Brass 黄铜
Surface treatment 表面处理	Tin-plated 镀锡

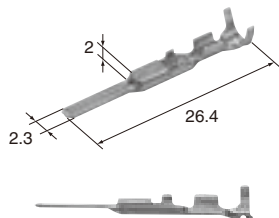
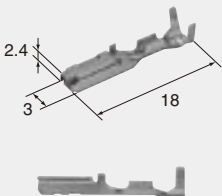
**M (8230-4552)****F (8100-1428)**

Cable size (mm²) 适用电线大小	1.25~2.0
Material 材质	Heat-resistant copper alloy
Surface treatment 表面处理	Tin-plated 镀锡

(L)**Au****F (8100-1459)**

Cable size (mm²) 适用电线大小	1.25~2.0
Material 材质	Heat-resistant copper alloy
Surface treatment 表面处理	Gold-plated 镀金

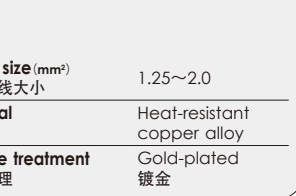

Cable size (mm²) 适用电线大小	1.25~2.0
Material 材质	Heat-resistant copper alloy
Surface treatment 表面处理	Gold-plated 镀金

2.3mm (090)

Wire seals (UNIT : mm)

电线密封栓(毫米)

- The wire seals are common to M and F.
- 电线密封栓为公端、母端共用。

(S)

(7165-0118)

Cable overall diameter(mm) Over than 1.5 mm below 2.0 mm
带绝缘层外径 超过1.5mm在2.0mm以下

Material NBR

Color Blue
颜色 蓝

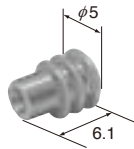

(SS)

(7165-0210)

Cable overall diameter(mm) Over than 1.1 mm below 1.5 mm
带绝缘层外径 超过1.1mm在1.5mm以下

Material NBR

Color Red
颜色 红

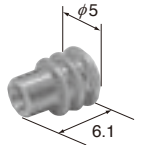

(M)

(7165-0119)

Cable overall diameter(mm) Over than 2.0 mm below 2.9 mm
带绝缘层外径 超过2.0mm在2.9mm以下

Material NBR

Color Brown
颜色 棕

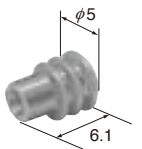

2.3mm (090)

Dummy plugs (UNIT : mm)

盲塞(毫米)

Ref; 2.3mm Dummy plug detail

2.3mm盲塞参照页

(7161-9787) B-15

(7165-0193) J-07

- Dummy plugs are common to M and F.
- Dummy plugs are used to blind unused terminal holes.
- 盲塞为公端、母端共用。
- 盲塞用于堵塞不使用的端子孔。

2.3mm (090)

Housing (UNIT : mm)

接插件护套(毫米)

Ref: Terminal part No. L-02
端子参照页

Ref: wire seal No. L-04
电线密封栓参照页

Ref: Dummy plug No. B-11 J-07
盲塞参照页

Material PBT or Low water absorption Nylon
材质

1way

Color Dark Gray
颜色 深灰

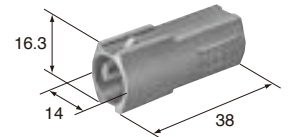

M (6195-0240)

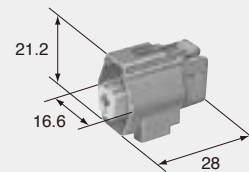

Color Dark Gray
颜色 深灰
Note L-07
备注 Bracket Clamp : TYPE2

F (6195-0066)

2way

Color Dark Gray
颜色 深灰

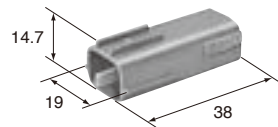

M (6195-0006)

F (6195-0003)

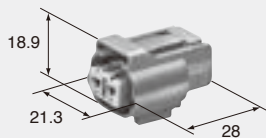

Color Dark Gray
颜色 深灰
Note L-07
备注 Bracket Clamp : TYPE2

3way

Color Dark Gray
颜色 深灰

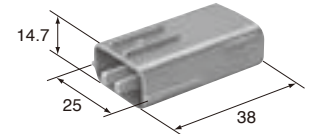

M (6195-0012)

F (6195-0009)

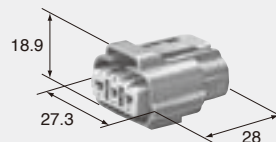

Color Dark Gray
颜色 深灰
Note L-07
备注 Bracket Clamp : TYPE2

4way

Color Dark Gray
颜色 深灰

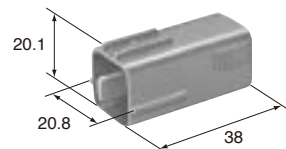

M (6195-0018)

F (6195-0015)

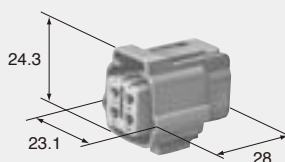

Color Dark Gray
颜色 深灰
Note L-07
备注 Bracket Clamp : TYPE2

6way

Color Dark Gray
颜色 深灰

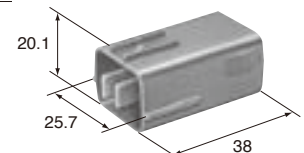

M (6195-0024)

F (6195-0021)

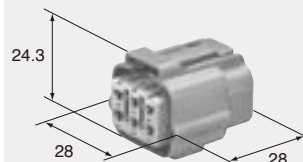

Color Dark Gray
颜色 深灰
Note L-07
备注 Bracket Clamp : TYPE2

8way

Color Dark Gray
颜色 深灰

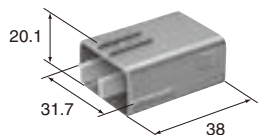

M (6195-0054) **F (6195-0051)**

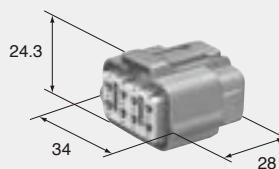

Color Dark Gray
颜色 深灰
Note L-07
备注 Bracket Clamp : TYPE2

10way

Color Light Gray
颜色 浅灰

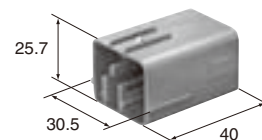

M (6195-0167) **F (6195-0164)**

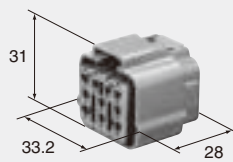

Color Light Gray
颜色 浅灰
Note L-07
备注 Bracket Clamp : TYPE2

12way

Color Dark Gray
颜色 深灰

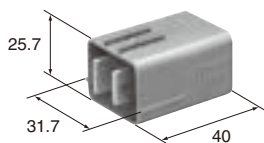

M (6195-0152) **F (6195-0149)**

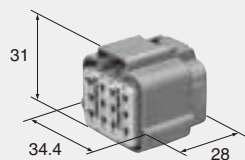

Color Dark Gray
颜色 深灰
Note L-07
备注 Bracket Clamp : TYPE2

16way

Color Dark Gray
颜色 深灰

Note L-07
备注 Bracket Clamp : TYPE1

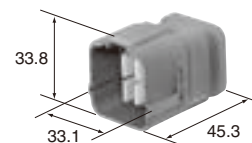

M (6188-0495) **F (6189-0715)**

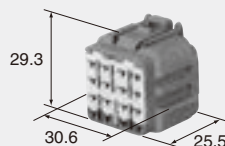

Color Dark Gray
颜色 深灰

DL SEALED SERIES COMMON USE PARTS

Body fastening clamp (mm)

2.3mm standard type connectors, the clamp can be installed.

※ The detail dimensions for the mounting portion are specified in drawing
根据需求可以在2.3mm 标准的接插件上，安装用于固定在车体上的卡钉。

※安装部位的详细尺寸另行图纸规定。

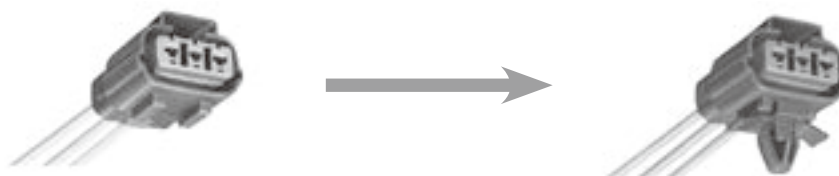

Type 1

(6810-2653)

Material 材质	PA6T
Color 颜色	Natural 自然色
hole size 孔径	φ 7.0
Plate thickness range for clamp 卡钉适合板厚	t=0.6~1.6

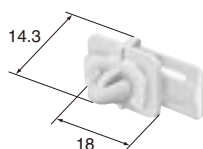

Type 2

(6810-1584)

Material 材质	PBT
Color 颜色	Brown 棕
hole size 孔径	7.2×10.2
Plate thickness range for clamp 卡钉适合板厚	t=0.7~2.0

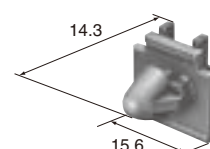

HFC III SERIES

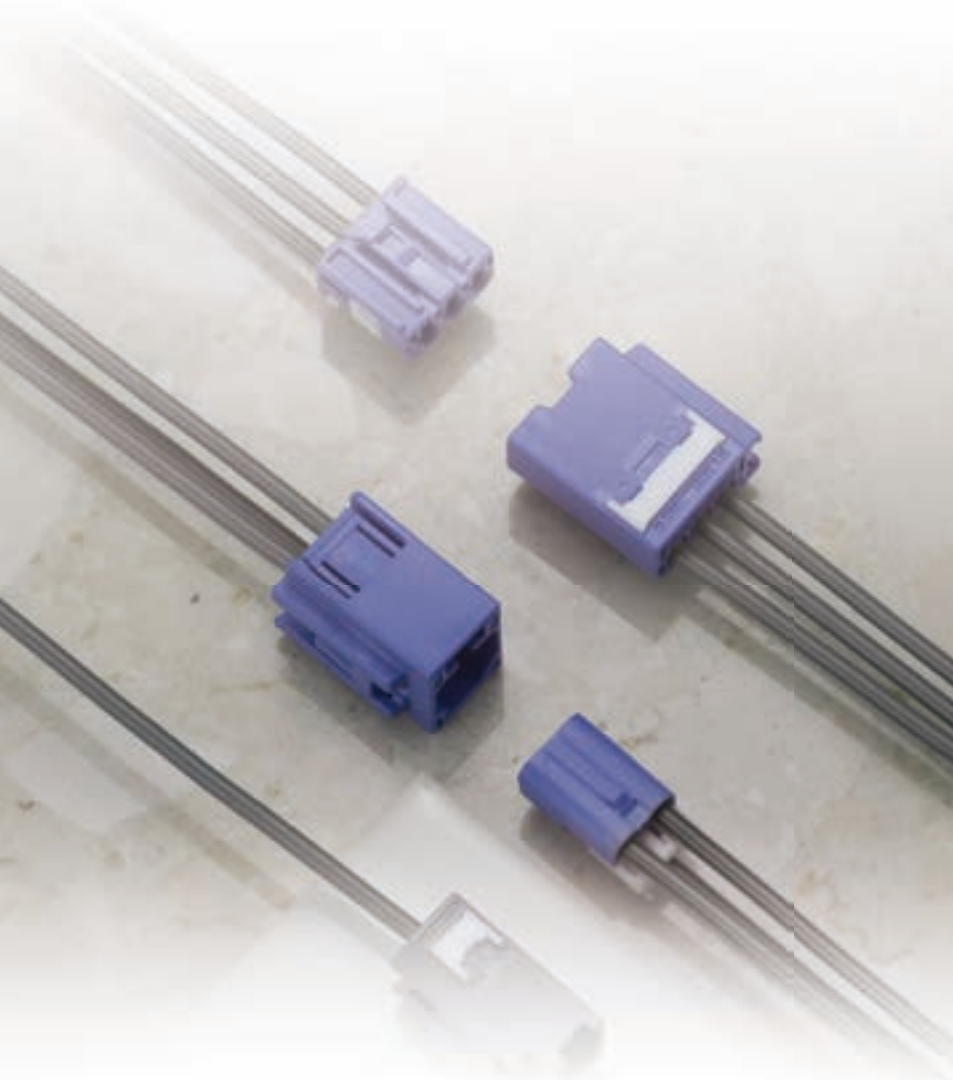

Features

HFC III (High Frequency Connector) series are connectors that connect on-board multimedia devices, such as GPS, TV, VICS and etc., and coaxial wires. These are also suitable for mobile telephone and sensor circuit.

- It reduces reflection/transmission loss and restrains noise radiation. It achieved smaller size with higher performance.
- Hybrid types for high frequency coaxial wire and automobile wire (AV) are established. (It supports diversity receiving system).
- Retainer for secondary lock is preloaded and the structure allows the high frequency coaxial wire and AV wire to be set by one operation. Therefore improvement of assembling operation can be planned.
- RoHS/ELV Compliant

特点

HFC III系列（高频接插件）使用于GPS·TV·VICS等车载多媒体模块相同的同轴线连接用接插件，也适用于车载电话、传感器回路上。

- 制止传送损失、反射、杂讯放射、实现了小型高性能化。
- 设定了高频同轴线和汽车用电线(AV)的混合型。(可以应用于多样性收信方式。)
- 通过预先安装双重锁定锁片、高频同轴线与AV线都能够通过简单的操作进行安装，可提高效率。
- 可对应欧盟RoHS和ELV指令

HFC III SERIES for STANDARD

Structure / 构造

M-02

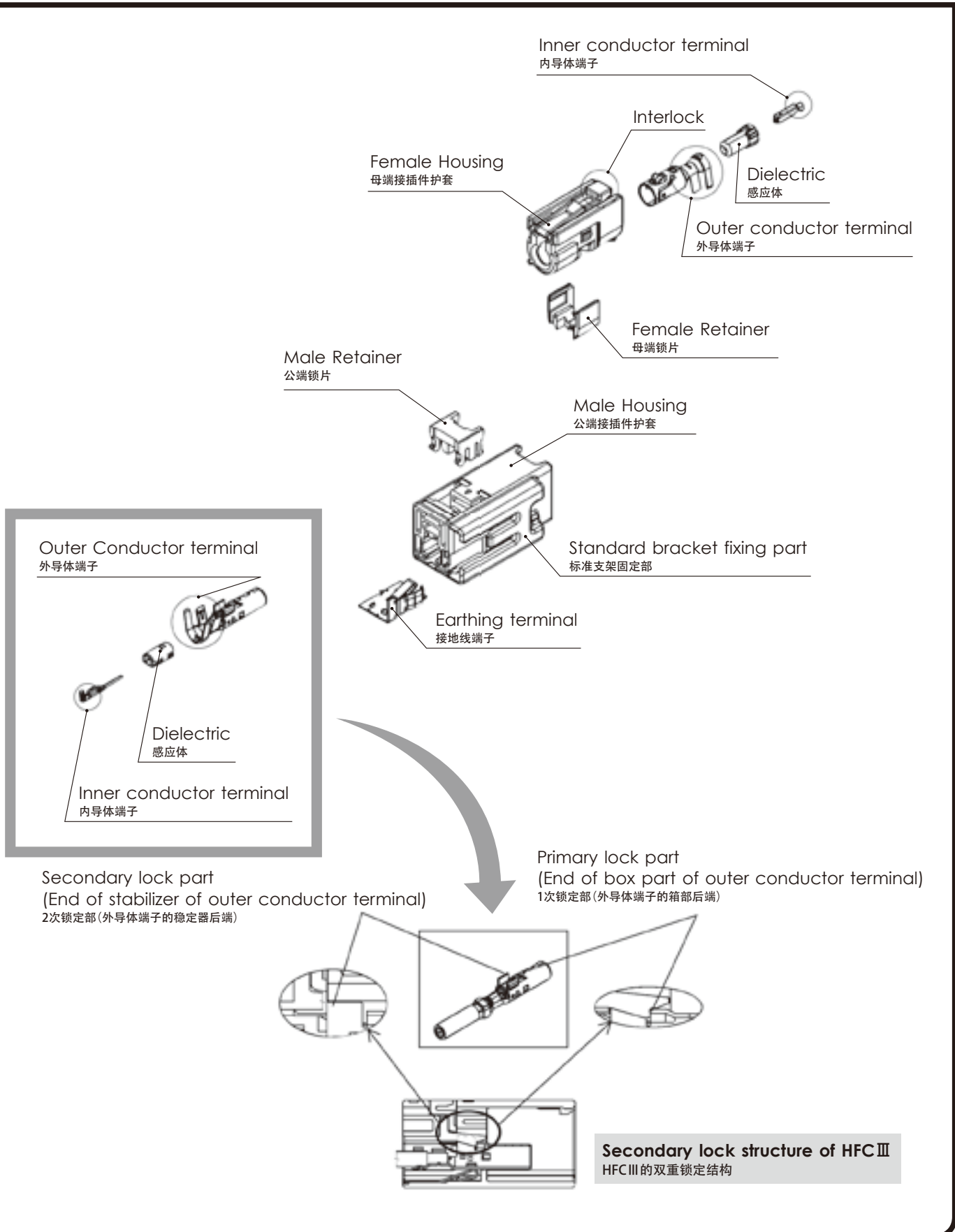

Secondary lock structure of HFC III
HFC III 的双重锁定结构

Basic specification / 基本规格

Type		1 way coaxial wire 2 way coaxial wire + 1 way AV wire 2 way coaxial wire + 2 way AV wire 3 way coaxial wire 4 way coaxial wire + 2 way AV wire		
Contact resistance 接触电阻	Coaxial wire 同轴线	Max. 20mΩ (Initial / 初期)		
	AV wire AV线	Max. 8mΩ (Initial / 初期)		
Insulation resistance 绝缘电阻		Min. 100MΩ		
Working temperature 使用温度		-40°C ~ +105°C		
VSWR	75Ω系	~180MHz	Wire to Wire PCB to Wire	Max. 1.2
		~770MHz	Wire to Wire PCB to Wire	
	50Ω系		~3GHz	Wire to Wire
		PCB to Wire		Max. 1.3

Material 材质	M Terminal	Inner conductor 内导体	Brass (Sn plating) 黄铜 (镀锡)
		Outer conductor 外导体	
	F Terminal	Inner conductor 内导体	Heat resistant cooper-alloy (Au plating) 耐热铜合金 (镀金)
		Outer conductor 外导体	Brass (Sn plating) 黄铜 (镀锡)

(Note) AV wire = MAX. AVSS 0.5mm² (Terminal is TS 0.64 type: Ref. A-02).
注) AV线 = 最大AVSS 0.5mm² (端子为TS0.64: 参照A-02)

Inner conductor terminal (mm) / 内导体端子 (毫米)

(M)

S (8230-5015) M (8230-5016) L (8230-5017)



(F)

S (8240-0276) M (8240-0277) L (8240-0278)



Outer conductor terminal (mm) / 外导体端子 (毫米)

(M)

S (8230-5481) M (8230-5482) L (8230-5484)



(F)

转 播 用 : S (8240-0382) M (8240-0383) F (8240-0619)
无 线 电 用 : S (8240-0387) M (8240-0388)

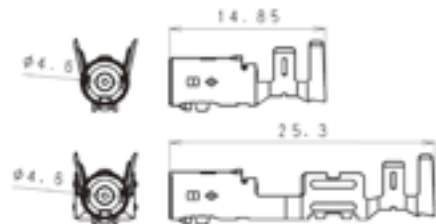

(Note) The terminal for radio can connect a condenser inside. On this occasion, a common crimping terminal is necessary.
注) 无线电用端子内部可以连接电容器。此时需要共同的压接端子 (8110-4493)。

Applicable coaxial wire / 适用同轴线

Applicable coaxial wire (Note 1) 适用同轴线 注1)	1.5C-2V	1.5C-2W	1.5D-2V	1.5D-2W	2.5D
Inner conductor terminal 内导体端子	S	S	M	M	L
Outer conductor terminal 外导体端子	S	M	S	S	F

(Note 1) For some coaxial wire and wire makers, it might be inapplicable. Please contact our sales representative for more details.

注1) 由于各电线商家的同轴线不同, 是否适用请向敝公司的销售负责人询问
注2) 泡沫聚乙烯绝缘同轴线压接时需要使用套管。

Housing (UNIT : mm)

接插件护套(毫米)

Ref: Terminal part No.

端子参照页

coaxial wire M-03
同轴线

AV wire A-02
AV线

1way coaxial wire Rib R1

Color Blue
颜色 蓝

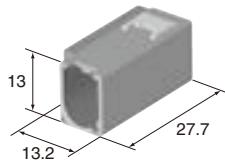

M (6098-7143)

F (6098-6321)

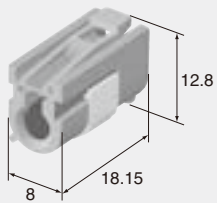

Color Blue
颜色 蓝

1way coaxial wire Rib L1

Color Gray
颜色 灰

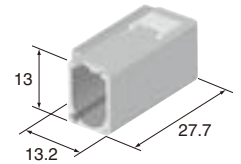

M (6098-6835)

F (6098-6323)

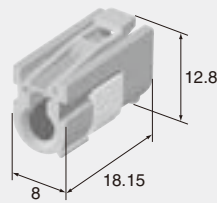

Color Gray
颜色 灰

1way coaxial wire Rib R2

Color Black
颜色 黑

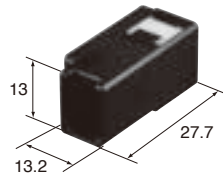

M (6098-7544)

F (6098-7445)

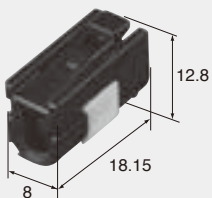

Color Black
颜色 黑

1way coaxial wire Rib L2

Color Natural
颜色 自然色

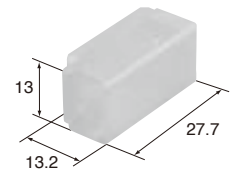

M (6098-7546)

F (6098-7446)

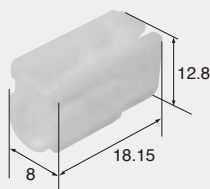

Color Natural
颜色 自然色

M-04

2 way coaxial wire + 1 way AV wire **Rib R**

Color 颜色 Gray 灰

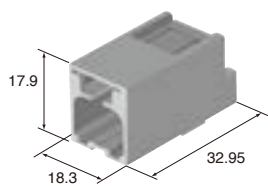

M (6098-6331)

Color 颜色 Gray 灰

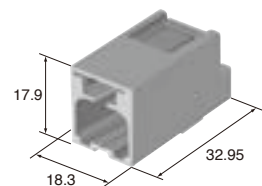

F (6098-6336)

M (6098-6373)

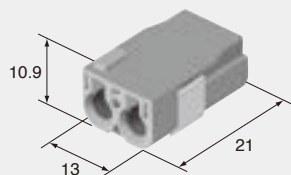

Color 颜色 Gray 灰

2 way coaxial wire + 1 way AV wire **Rib L**

Color 颜色 Natural 自然色

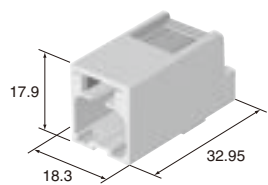

M (6098-6328)

Color 颜色 Natural 自然色

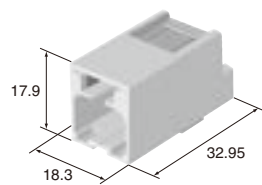

F (6098-6333)

M (6098-6370)

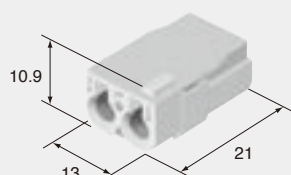

Color 颜色 Natural 自然色

M-05
HFC III SERIES

2 way coaxial wire + 2 way AV wire **Rib R**

Color 颜色 Gray 灰

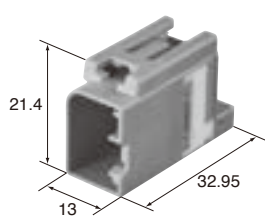

M (6098-7151)

F (6098-7153)

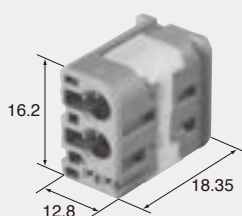

Color 颜色 Gray 灰

2 way coaxial wire + 2 way AV wire **Rib L**

Color 颜色 Natural 自然色

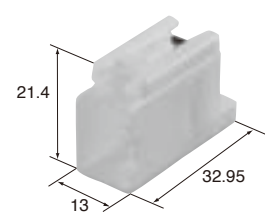

M (6098-7145)

F (6098-7148)

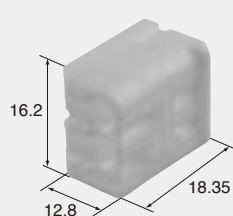

Color 颜色 Natural 自然色

3 way coaxial wire

Color Blue
颜色 蓝

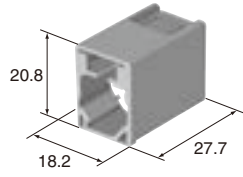

M (6098-6340)

Color Blue
颜色 蓝

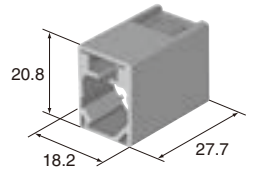

M (6098-6369)

F (6098-6343)

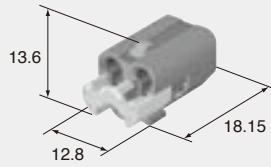

Color Blue
颜色 蓝

3 way coaxial wire

Color Blue
颜色 蓝

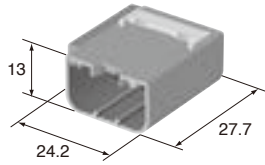

M (6098-6838)

F (6098-6841)

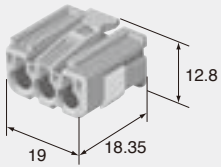

Color Blue
颜色 蓝

4 way coaxial wire + 2 way AV wire

Color Natural
颜色 自然色

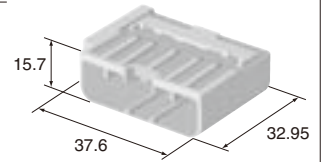

M (6098-6844)

F (6098-6702)

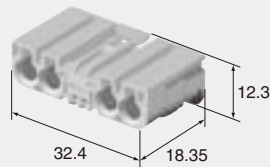

Color Natural
颜色 自然色

M-06

1 way coaxial wire

SMT Type (Rib R1)

M (6098-7132)

Connector F part No. 6098-6321 (M-04)
母端接插件产品号码
Color Blue
颜色 蓝

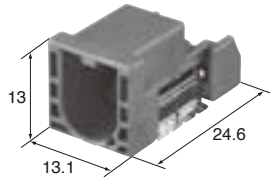

● Detailed dimension
详细尺寸



● Recommended demension of
Circuit board
电路板推荐尺寸



1 way coaxial wire

SMT Type (Rib R2)

M (6098-7449)

Connector F part No. 6098-7445 (M-04)
母端接插件产品号码
Color Black
颜色 黑

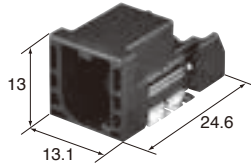

● Detailed dimension
详细尺寸



● Recommended demension of
Circuit board
电路板推荐尺寸



M-08

1 way coaxial wire

SMT Type (Rib L1)

M (6098-7134)

Connector F part No. 6098-6323 (M-04)
母端接插件产品号码
Color Gray
颜色 灰

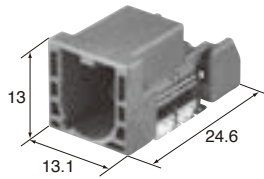

● Detailed dimension
详细尺寸



● Recommended demension of
Circuit board
电路板推荐尺寸



1 way coaxial wire

SMT Type (Rib L2)

M (6098-7450)

Connector F part No. 6098-7446 (M-04)
母端接插件产品号码
Color Natural
颜色 自然色

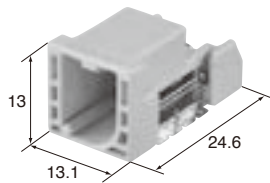

● Detailed dimension
详细尺寸



● Recommended demension of
Circuit board
电路板推荐尺寸



INDEX

Part No.	Page
1500-0159	L-03
1500-0166	C-12
1500-0169	L-03
5010-8627	E-08
5011-1590	E-08
5011-6687	E-08
5011-6818	E-12
5011-7740	E-12
5011-7860	E-12
6098-0149	A-16
6098-0151	A-16
6098-0154	A-17
6098-0156	A-17
6098-0323	A-16
6098-0325	A-16
6098-0441	A-19
6098-0469	A-16
6098-0471	A-16
6098-0518	A-16
6098-0822	A-15
6098-0824	A-15
6098-1104	A-19
6098-1278	A-19
6098-1373	C-11
6098-1377	C-11
6098-1378	C-11
6098-1380	C-11
6098-1489	A-16
6098-1624	K-06
6098-1626	K-06
6098-1627	I-07
6098-1714	I-06
6098-1716	A-16
6098-1744	I-07
6098-1746	I-07
6098-1747	I-06
6098-1774	I-06
6098-1851	A-16
6098-2013	K-05
6098-2101	I-06
6098-2137	A-19
6098-2158	K-05
6098-2206	K-06
6098-2208	K-06
6098-2211	A-16
6098-2289	K-06
6098-2329	G-11
6098-2679	I-06

Part No.	Page
6098-2680	I-06
6098-2764	C-08
6098-2779	C-07
6098-2780	C-07
6098-2781	C-07
6098-2782	C-07
6098-2784	C-08
6098-2785	C-08
6098-2786	C-19
6098-2788	C-08
6098-2789	C-08
6098-3239	C-22
6098-3369	C-08
6098-3370	C-19
6098-3449	I-04
6098-3450	I-10
6098-3452	I-09
6098-3453	I-04
6098-3456	I-03
6098-3458	I-10
6098-3563	C-11
6098-3565	C-20
6098-3567	C-21
6098-3569	C-21
6098-3571	C-18
6098-3572	C-22
6098-3600	C-18
6098-3601	C-18
6098-3616	C-23
6098-3802	A-04
6098-3810	A-04
6098-3818	A-22
6098-3826	A-22
6098-3869	A-04
6098-3877	A-04
6098-3885	A-05
6098-3893	A-21
6098-3901	A-22
6098-3909	A-04
6098-3917	A-04
6098-3925	A-05
6098-3933	A-21
6098-3941	A-22
6098-4008	A-05
6098-4010	A-05
6098-4013	A-05
6098-4015	A-06
6098-4017	C-19

Part No.	Page
6098-4018	C-23
6098-4050	C-11
6098-4069	C-10
6098-4071	C-10
6098-4073	C-10
6098-4075	C-18
6098-4076	C-18
6098-4333	C-04
6098-4339	C-04
6098-4367	C-18
6098-4565	K-03
6098-4567	K-03
6098-4569	K-03
6098-4588	C-04
6098-4589	C-04
6098-4590	C-05
6098-4591	C-16
6098-4594	C-04
6098-4595	C-04
6098-4596	C-05
6098-4597	C-16
6098-4640	C-04
6098-4660	C-20
6098-4661	C-11
6098-4662	C-11
6098-4663	C-13
6098-4664	C-11
6098-4666	C-18
6098-4667	C-13
6098-4669	C-11
6098-4670	C-11
6098-4675	C-04
6098-4707	C-17
6098-4725	C-17
6098-4726	C-17
6098-4740	A-06
6098-4756	A-05
6098-4831	A-06
6098-4876	I-04
6098-4877	I-04
6098-4901	C-10
6098-4902	C-10
6098-4908	C-16
6098-4943	C-04
6098-4944	C-03
6098-4971	C-13
6098-4973	C-14
6098-4974	C-14

Part No.	Page
6098-4975	C-15
6098-4977	C-15
6098-4978	C-03
6098-4979	C-04
6098-4982	C-04
6098-5000	C-04
6098-5049	C-10
6098-5070	C-03
6098-5071	C-03
6098-5119	C-13
6098-5120	C-13
6098-5180	C-16
6098-5217	C-20
6098-5218	C-20
6098-5267	F-03
6098-5269	F-03
6098-5271	F-03
6098-5273	F-04
6098-5275	F-04
6098-5277	F-04
6098-5279	F-05
6098-5281	F-05
6098-5283	F-05
6098-5285	F-05
6098-5287	F-06
6098-5289	F-06
6098-5291	F-06
6098-5293	F-06
6098-5295	F-06
6098-5297	F-06
6098-5310	F-03
6098-5312	F-04
6098-5585	F-06
6098-5594	A-21
6098-5604	A-21
6098-5613	A-21
6098-5622	A-21
6098-5631	A-21
6098-5641	A-21
6098-5650	A-20
6098-5659	A-20
6098-5668	A-09
6098-5677	A-09
6098-5686	A-09
6098-5695	A-09
6098-5704	A-09
6098-5713	A-09
6098-5761	M-09

Part No.	Page
6098-5833	C-03
6098-5888	C-07
6098-5903	A-22
6098-5988	F-08
6098-5989	F-08
6098-6037	M-09
6098-6050	A-09
6098-6053	A-09
6098-6055	A-20
6098-6083	A-20
6098-6090	A-20
6098-6097	A-20
6098-6104	A-20
6098-6111	A-20
6098-6157	M-07
6098-6159	M-07
6098-6161	C-16
6098-6162	C-16
6098-6321	M-04
6098-6323	M-04
6098-6328	M-05
6098-6331	M-05
6098-6333	M-05
6098-6336	M-05
6098-6340	M-06
6098-6343	M-06
6098-6369	M-06
6098-6370	M-05
6098-6373	M-05
6098-6451	F-04
6098-6452	F-04
6098-6455	F-04
6098-6456	F-04
6098-6457	F-05
6098-6478	C-16
6098-6522	F-04
6098-6523	F-04
6098-6524	F-05
6098-6559	C-17
6098-6562	C-16
6098-6653	A-04
6098-6662	A-04
6098-6682	A-05
6098-6688	A-05
6098-6694	A-05
6098-6700	M-07
6098-6702	M-06
6098-6790	A-24

Part No.	Page
6098-6793	A-24
6098-6796	A-25
6098-6798	A-25
6098-6803	A-25
6098-6805	A-25
6098-6810	A-26
6098-6835	M-04
6098-6838	M-06
6098-6841	M-06
6098-6844	M-06
6098-6848	A-25
6098-6861	M-09
6098-6869	A-26
6098-7060	F-05
6098-7061	F-05
6098-7063	F-03
6098-7066	F-04
6098-7067	F-04
6098-7099	F-05
6098-7100	F-05
6098-7102	A-26
6098-7132	M-08
6098-7134	M-08
6098-7143	M-04
6098-7145	M-05
6098-7148	M-05
6098-7151	M-05
6098-7153	M-05
6098-7229	A-24
6098-7231	A-05
6098-7241	A-04
6098-7253	F-08
6098-7254	F-08
6098-7261	F-08
6098-7336	A-05
6098-7445	M-04
6098-7446	M-04
6098-7449	M-08
6098-7450	M-08
6098-7544	M-04
6098-7546	M-04
6098-8478	I-06
6098-8480	I-09
6098-8482	I-04
6181-0381	E-22
6181-0436	J-07
6181-0437	J-08
6181-0438	J-08

Part No.	Page
6181-0439	J-08
6181-0440	J-08
6181-0511	G-09
6181-0512	G-10
6181-0513	G-09
6181-0514	G-09
6181-0515	G-08
6181-0516	G-09
6181-0522	G-10
6181-0532	G-09
6181-0536	G-09
6181-0613	J-10
6181-0629	J-05
6181-0664	G-09
6181-0665	G-09
6181-0666	G-10
6181-0667	G-10
6181-0668	G-09
6181-0669	G-09
6181-0670	G-08
6181-0671	G-09
6181-0803	E-19
6181-6464	E-21
6181-6465	E-21
6181-6481	D-04
6181-6492	J-04
6181-6509	J-04
6181-6614	J-04
6181-6658	H-03
6181-6783	E-16
6181-6784	E-16
6181-6785	E-21
6181-6850	E-16
6181-6851	E-15
6181-6921	E-22
6185-0862	G-05
6185-0865	G-05
6185-0866	G-05
6185-0867	G-05
6185-0868	G-06
6185-0869	G-05
6185-1101	G-05
6185-1169	G-06
6185-1171	G-06
6185-4596	E-21
6185-5175	G-06
6185-5177	G-06
6185-5179	G-07

Part No.	Page
6185-5181	G-06
6188-0047	B-15
6188-0049	B-25
6188-0066	B-17
6188-0067	B-18
6188-0083	B-21
6188-0091	B-29
6188-0096	B-25
6188-0099	B-16
6188-0101	B-29
6188-0108	B-15
6188-0129	B-22
6188-0141	B-17
6188-0173	B-18
6188-0175	B-18
6188-0187	B-29
6188-0209	B-18
6188-0217	B-17
6188-0221	B-29
6188-0229	B-16
6188-0259	B-21
6188-0266	B-15
6188-0282	B-17
6188-0327	B-18
6188-0415	B-29
6188-0470	B-16
6188-0472	B-18
6188-0495	L-06
6188-0517	B-17
6188-0551	G-05
6188-0552	G-05
6188-0553	G-05
6188-0554	G-05
6188-0555	G-06
6188-0556	G-05
6188-0557	G-06
6188-0558	G-06
6188-0589	E-04
6188-0590	E-04
6188-0624	B-16
6188-0657	E-04
6188-0658	E-05
6188-0660	E-07
6188-0663	G-05
6188-0696	B-06
6188-0697	E-09
6188-0698	E-09
6188-0706	B-06

INDEX

Part No.	Page
6188-0779	B-06
6188-4739	E-05
6188-4775	D-03
6188-4776	D-04
6188-4787	E-08
6188-4789	E-08
6188-4797	B-05
6188-4908	D-04
6188-4914	B-06
6188-4920	B-05
6188-5103	B-27
6188-5295	B-26
6188-5516	B-10
6188-5539	G-06
6188-5540	G-06
6188-5542	G-07
6188-5544	G-06
6189-0100	B-15
6189-0101	B-25
6189-0126	B-17
6189-0127	B-18
6189-0143	B-29
6189-0144	B-29
6189-0145	B-21
6189-0165	B-22
6189-0166	B-29
6189-0172	B-25
6189-0179	B-16
6189-0181	B-29
6189-0199	B-15
6189-0249	B-15
6189-0264	B-16
6189-0319	B-18
6189-0323	B-18
6189-0368	B-18
6189-0372	B-17
6189-0376	B-29
6189-0381	B-17
6189-0388	B-16
6189-0413	B-21
6189-0425	B-21
6189-0443	B-17
6189-0504	B-18
6189-0552	E-19
6189-0555	E-22
6189-0566	B-16
6189-0573	B-16
6189-0591	E-19

Part No.	Page
6189-0593	E-19
6189-0596	E-19
6189-0611	B-16
6189-0617	E-19
6189-0629	B-17
6189-0639	J-07
6189-0640	J-08
6189-0643	J-08
6189-0648	J-08
6189-0682	B-16
6189-0685	B-18
6189-0694	B-17
6189-0715	L-06
6189-0772	G-11
6189-0773	G-12
6189-0774	G-12
6189-0775	G-12
6189-0776	G-12
6189-0777	G-12
6189-0778	G-12
6189-0855	E-05
6189-0856	B-25
6189-0887	E-05
6189-0890	E-04
6189-0891	E-04
6189-0915	J-10
6189-0928	G-09
6189-0940	E-04
6189-0950	G-09
6189-0951	G-08
6189-0954	G-10
6189-0955	G-10
6189-0968	E-05
6189-1012	E-05
6189-1046	B-05
6189-1048	B-27
6189-1050	E-09
6189-1051	E-09
6189-1073	J-04
6189-1076	J-04
6189-1081	E-05
6189-1082	E-07
6189-1082	E-08
6189-1083	B-06
6189-1092	B-06
6189-1093	G-12
6189-1094	G-12
6189-1095	G-12

Part No.	Page
6189-1096	G-12
6189-1097	G-12
6189-1104	G-09
6189-1107	G-08
6189-1108	G-10
6189-1109	G-10
6189-1115	J-04
6189-1128	B-06
6189-1129	B-05
6189-1132	B-05
6189-1133	B-06
6189-1134	B-06
6189-1135	B-07
6189-1136	B-27
6189-1142	B-06
6189-1144	J-05
6189-1147	J-05
6189-1149	J-05
6189-1150	J-05
6189-1160	B-27
6189-1161	B-05
6189-1231	B-05
6189-1240	B-06
6189-6863	E-21
6189-6894	B-27
6189-6906	D-04
6189-6909	D-04
6189-6914	E-08
6189-6934	B-26
6189-6953	B-25
6189-6978	B-27
6189-6979	B-27
6189-6980	B-27
6189-6981	B-27
6189-6987	B-07
6189-7020	B-05
6189-7036	D-03
6189-7037	D-03
6189-7039	D-04
6189-7040	D-04
6189-7052	D-03
6189-7058	D-03
6189-7073	B-05
6189-7077	B-26
6189-7094	B-28
6189-7100	B-06
6189-7110	B-07
6189-7115	J-05

Part No.	Page
6189-7156	B-30
6189-7167	B-07
6189-7188	H-03
6189-7189	H-03
6189-7190	H-03
6189-7214	H-03
6189-7256	B-26
6189-7262	J-05
6189-7263	E-12
6189-7264	E-12
6189-7393	G-13
6189-7398	B-17
6189-7401	B-05
6189-7408	E-15
6189-7409	E-16
6189-7410	E-16
6189-7411	E-21
6189-7423	E-16
6189-7426	B-27
6189-7433	B-11
6189-7434	B-11
6189-7435	B-11
6189-7436	B-11
6189-7449	B-10
6189-7469	G-12
6189-7470	G-12
6189-7471	G-12
6189-7494	E-16
6189-7546	B-11
6189-7547	B-11
6189-7567	E-22
6189-7691	B-26
6189-7710	G-12
6189-7711	G-12
6189-7713	G-12
6189-7714	G-12
6189-7716	G-12
6189-7717	G-12
6189-7756	G-09
6189-7757	G-09
6189-7758	G-09
6189-7759	G-09
6189-7760	G-09
6189-7761	G-09
6189-7762	G-09
6189-7763	G-09
6189-7784	J-08
6189-7809	B-28

Part No.	Page
6195-0003	L-05
6195-0006	L-05
6195-0009	L-05
6195-0012	L-05
6195-0015	L-05
6195-0018	L-05
6195-0021	L-05
6195-0024	L-05
6195-0051	L-06
6195-0054	L-06
6195-0066	L-05
6195-0149	L-06
6195-0152	L-06
6195-0164	L-06
6195-0167	L-06
6195-0240	L-05
6240-1033	A-13
6240-1077	A-12
6240-1093	A-19
6240-1107	A-12
6240-1120	A-12
6240-1122	A-13
6240-1158	A-13
6240-5035	A-13
6240-5088	A-13
6240-5118	A-12
6240-5175	A-13
6240-5337	I-06
6240-5339	I-06
6240-5378	C-11
6241-0241	A-23
6241-0261	A-22
6241-0281	A-23
6245-0261	A-23
6245-0281	A-22
6245-0301	A-23
6248-5270	A-12
6248-5275	A-13
6248-5276	A-13
6248-5309	K-08
6248-5310	K-08
6248-5311	K-08
6249-1229	A-12
6249-1234	A-13
6249-1235	A-13
6249-1243	A-12
6249-1248	K-08
6249-1249	K-08

Part No.	Page
6249-1250	K-08
6249-1251	K-08
6249-1252	K-08
6249-1253	K-08
6249-1265	K-08
6249-1266	K-08
6520-0549	A-12
6520-0550	A-12
6520-1004	A-13
6520-1009	A-13
6520-1466	A-19
6810-1203	C-24
6810-1204	C-24
6810-1217	C-24
6810-1462	C-24
6810-1584	J-11
6810-1584	L-07
6810-2653	L-07
6810-4982	J-11
6910-0119	C-24
6910-0120	C-24
6911-5774	B-11
6911-5948	B-28
6914-0050	E-07
6914-0127	E-11
6918-1260	E-19
6918-1263	E-22
6918-1267	E-22
6918-1370	E-19
6918-1371	E-19
6918-1469	E-19
6918-1594	G-11
6918-1594	G-12
6918-1595	G-12
6918-1596	G-12
6918-1597	G-13
6918-1598	G-09
6918-1599	G-09
6918-1600	G-09
6918-1601	G-09
6918-1602	G-10
6918-1603	G-10
6918-1604	G-12
6918-1636	G-11
6918-1651	G-08
6918-1651	G-09
6918-1652	G-09
6918-1653	G-08

Part No.	Page
6918-1653	G-09
6918-1654	G-09
6918-1762	E-05
6918-1773	G-05
6918-1774	G-05
6918-1775	G-05
6918-1775	G-06
6918-1776	G-06
6918-1779	G-06
6918-1780	G-06
6918-1780	G-07
6918-1833	D-03
6918-1833	E-05
6918-1835	D-03
6918-1835	E-04
6918-1979	E-04
6918-2056	E-05
6918-2103	E-09
6918-2104	E-09
6918-2128	D-04
6918-2128	E-05
6918-2131	E-07
6918-2132	E-07
6918-2132	E-08
6918-2665	E-19
6918-2804	D-04
6918-2806	D-04
6918-2810	D-04
6918-2913	D-04
6918-3166	E-12
6920-0861	E-09
6920-0884	E-09
6920-0886	E-09
6920-2376	E-09
6920-2377	E-09
6920-2446	E-09
6950-1054	C-20
6950-1055	C-20
6950-1056	C-20
7160-9465	B-15
7161-9787	B-15
7161-9787	J-04
7161-9787	L-04
7165-0118	L-04
7165-0119	L-04
7165-0130	E-20
7165-0131	E-21
7165-0145	B-21

Part No.	Page
7165-0147	E-21
7165-0148	E-21
7165-0172	E-20
7165-0180	B-25
7165-0180	J-10
7165-0193	E-07
7165-0193	E-18
7165-0193	H-03
7165-0193	J-04
7165-0193	J-07
7165-0193	L-04
7165-0194	E-18
7165-0198	E-18
7165-0210	L-04
7165-0342	B-14
7165-0343	B-14
7165-0344	B-14
7165-0346	B-20
7165-0347	B-20
7165-0348	B-20
7165-0349	B-14
7165-0351	B-14
7165-0356	B-20
7165-0385	E-18
7165-0392	B-24
7165-0392	J-10
7165-0393	B-24
7165-0393	J-10
7165-0395	B-14
7165-0400	B-24
7165-0400	J-10
7165-0432	D-03
7165-0432	E-04
7165-0471	G-04
7165-0472	G-04
7165-0473	G-04
7165-0474	G-04
7165-0514	H-02
7165-0514	J-04
7165-0514	J-07
7165-0515	H-02
7165-0515	J-04
7165-0515	J-07
7165-0516	H-02
7165-0516	J-04
7165-0516	J-07
7165-0621	D-02
7165-0621	E-03

INDEX

Part No.	Page
7165-0622	D-02 E-03
7165-0683	B-24
7165-0683	J-10
7165-0797	B-04
7165-0842	B-14
7165-1043	B-04
7165-1075	D-02 E-03
7165-1131	G-04
7165-1198	B-04
7165-1199	B-04
7165-1312	B-04
7165-1423	B-04
7165-1562	E-14
7165-1563	E-15
7165-1564	E-15
7165-1565	E-15
7165-1566	E-15
7165-1605	B-10
7165-1606	B-09
7165-1607	B-09
7165-1608	B-09
8100-0451	B-23
8100-0452	B-24
8100-0457	B-13
8100-0458	B-13
8100-0459	B-13
8100-0460	B-13
8100-0461	B-13
8100-0462	B-13
8100-0463	B-19 E-20
8100-0464	B-20 E-20
8100-0465	B-20 E-20
8100-0466	B-19
8100-0467	B-20
8100-0468	B-20 E-20
8100-0506	B-23
8100-0507	B-24
8100-0508	B-24
8100-0520	A-18 C-21
8100-0521	A-19 C-21

Part No.	Page
8100-0522	A-19 C-21
8100-0594	B-13
8100-0606	C-12
8100-0660	E-20
8100-0661	E-20
8100-0664	C-12
8100-0706	C-21
8100-0707	A-18 C-21
8100-0782	C-12
8100-0817	B-13
8100-1007	B-13
8100-1008	B-13
8100-1340	B-13
8100-1341	A-11
8100-1342	A-11
8100-1344	B-13
8100-1346	A-11
8100-1347	A-11
8100-1427	H-02 J-06 L-03
8100-1428	H-02 J-06 L-03
8100-1429	H-02 J-06 L-03
8100-1458	L-03
8100-1459	L-03
8100-1460	L-03
8100-1470	C-09
8100-1471	C-10
8100-1472	C-10
8100-1506	C-12
8100-1507	C-12
8100-1553	A-19 C-21
8100-1555	A-15
8100-1571	C-09
8100-1572	C-10
8100-1573	C-10
8100-1710	K-05
8100-2493	A-19
8100-2512	K-05
8100-2513	K-05
8100-2514	K-05

Part No.	Page
8100-2971	C-07
8100-2972	C-07
8100-2980	B-24
8100-3067	D-02 E-03
8100-3068	D-02 E-03
8100-3082	E-07
8100-3083	E-07
8100-3177	D-02 E-03
8100-3178	D-02 E-03
8100-3257	J-10
8100-3258	J-10
8100-3259	J-10
8100-3260	J-10
8100-3382	I-03
8100-3383	I-03
8100-3384	I-03
8100-3385	I-08
8100-3386	I-09
8100-3387	I-09
8100-3388	J-03
8100-3389	J-03
8100-3390	J-03
8100-3391	I-03
8100-3392	I-03
8100-3393	I-03
8100-3394	I-08
8100-3395	I-09
8100-3396	I-09
8100-3397	J-03
8100-3398	J-03
8100-3399	J-03
8100-3402	J-03
8100-3403	J-03
8100-3455	B-03
8100-3456	B-03
8100-3504	J-03
8100-3507	E-07
8100-3508	E-07
8100-3617	B-03
8100-3622	A-03
8100-3623	A-03
8100-3624	A-03
8100-3625	A-03
8100-3626	A-03

Part No.	Page
8100-3627	A-03
8100-3628	A-03
8100-3629	A-03
8100-3708	B-03
8100-3803	G-03
8100-3804	G-03
8100-3805	G-03
8100-3806	G-03
8100-4027	C-03 K-02
8100-4028	C-03 K-02
8100-4029	C-03 K-02
8100-4030	C-03 K-02
8100-4172	G-03
8100-4173	G-03
8100-4307	C-07
8100-4308	C-07
8230-4472	E-17 H-02 J-06 L-03
8230-4492	A-11 I-05 K-07
8230-4502	A-11 I-05 K-07
8230-4512	A-11 I-05 K-07
8230-4522	A-15
8230-4532	A-15
8230-4542	A-15
8230-4552	E-17 H-02 J-06 L-03
8230-4562	E-17 H-02 J-06 L-03
8230-4742	A-10
8230-4878	A-03
8230-4883	I-03
8230-4923	A-08

Part No.	Page
8230-4924	A-08
8230-4925	A-08
8230-5015	M-03
8230-5016	M-03
8230-5017	M-03
8230-5136	A-03
8230-5168	F-07
8230-5169	F-07
8230-5170	F-07
8230-5171	F-08
8230-5172	F-08
8230-5306	E-14
8230-5307	E-14
8230-5308	E-14
8230-5309	E-14
8230-5360	B-09
8230-5361	B-09
8230-5379	F-03
8230-5380	F-03
8230-5481	M-03
8230-5482	M-03
8230-5484	M-03
8240-0029	A-10
8240-0135	I-03
8240-0152	C-14
8240-0153	C-14
8240-0154	C-14
8240-0182	A-03
8240-0213	A-08
8240-0214	A-08
8240-0215	A-08
8240-0263	G-03
8240-0264	G-03
8240-0265	G-03
8240-0266	G-03
8240-0267	G-03
8240-0268	G-03
8240-0276	M-03
8240-0277	M-03
8240-0278	M-03
8240-0279	A-08
8240-0287	B-03
8240-0288	B-03
8240-0300	K-05
8240-0336	B-03
8240-0337	B-03
8240-0338	A-03
8240-0339	A-08

Part No.	Page
8240-0367	F-07
8240-0368	F-07
8240-0369	F-07
8240-0370	F-08
8240-0371	F-08
8240-0382	M-03
8240-0383	M-03
8240-0385	M-03
8240-0387	M-03
8240-0388	M-03
8240-0408	E-10
8240-0409	E-11
8240-0410	E-11
8240-0411	E-11
8240-0412	E-11
8240-0489	E-14
8240-0490	E-14
8240-0491	E-14
8240-0492	E-14
8240-0500	B-09
8240-0501	B-09
8240-0523	F-03
8240-0552	F-03
8240-4862	E-17
8240-4882	A-11 I-05 K-07
8240-4892	A-11 I-05 K-07
8240-4912	A-15
8240-4922	A-15
8240-4932	A-15
8240-4942	A-11 I-05 K-07
8240-4952	E-18
8240-4992	E-18

WARNING

Which may result in overheating or fire.

可能造成发热、起火!

Do not exceed prescribed current to the connectors.
Do not use a broken or cracked housing.
Do not use a deformed or rusty terminal.

- 请不要使用超出规定的电流值。
- 请不要使用有破损的或裂缝的接插件护套。
- 请不要使用变形的或已生锈的端子。

CAUTION

Precautions for Selection and Use of Connectors

选定、使用接插件时的注意事项

- To select a suitable connector, please consult with our sales staff about operating environment, mounting conditions, and other information (e.g. unsealed type for indoor compartment use, sealed type for engine compartment use).
- The performance of a connector may significantly vary depending on changes in variable elements in the operating environment, such as the number of ways, wire size, ambient temperature, etc.
For detailed electrical characteristics of each product, see the "Specifications" of the relevant series.
- We have "Specifications" for connector performance and "Instruction Manuals" for connector usage, handling, and precautions, which are available for each connector series. Please be sure to read these in advance to select the appropriate connector and to use it correctly.
- Some connector series require special attention during circuit checks, etc.
- Although some connector specifications include drawings showing mating support, these drawings are provided only for reference. The manufacture of mating parts is not possible without consideration to dimensional tolerances, etc.
- This catalogue include the parts that was designed and developed jointly with a customer and require prior approval before sales. Please contact our sales staff for details.
- 选定接插件时，针对使用环境、组装条件等问题，请与弊公司销售负责人商量以便选择出适合用途的产品（例如：室内选择非防水性的，发动机仓内选择防水性的等）。
- 接插件的性能的数值受极数、使用电线大小、周围温度等各种使用环境因素的影响，会产生很大的变化。
有关各产品的详细电流特性，请确认各系列的「式样书」。
- 本公司备有各系列接插件性能相关的「式样书」和接插件使用方法、处理方法、注意点相关的「使用说明书」。选定、使用接插件时，请务必阅读并正确使用。
- 针对不同系列的接插件，有需要注意导通检查的情况。
- 在产品目录中虽然有一部分接插件固定用支架以及对接端的内容，但仅为参考图使用，不可忽略相关的尺寸公差，随意制造对接端。
- 在产品目录中有一部分是与客户共同开发的产品。如需销售给别的客户时，需要事先得到其允许，具体事宜请向弊公司销售负责人询问。

*Product specifications may be subject to change without notice.
Before using the product, please obtain a "customer drawing"
"Specifications" "Instruction Manuals" from our sales staff.
Please contact our sales staff for details.

※※ 产品式样变更时可能不另行告知。
使用产品时，请向敝公司销售负责人索取「客户用图纸」「仕样书」「使用说明书」。
对上述相关详细内容，请向敝公司销售负责人询问。

住友电装集团

住电装贸易(上海)有限公司

中国上海市长宁区遵义路100号
虹桥上海城B栋1503-1506室
邮政编码 200051
电话 021-20286588 传真 021-20243251



■ 总公司

三重县四日市市滨田町5番28号
邮政编码 510-8528
电话 (059) 354-6200 传真 (059) 354-6318

■ 总公司东京

东京都港区元赤坂1丁目3番13号 (赤坂中心大厦11楼)
邮政编码 107-0051
电话 (03) 6384-5600 传真 (03) 6384-5601

销售部门一览

日本国内营业统辖部

名古屋营业部
名古屋市西区牛岛町6番1号 (名古屋朗讯大厦17楼)
邮政编码 451-6025
电话 (052) 582-6222 传真 (052) 582-6228

东京营业部
东京都港区元赤坂1丁目3番13号 (赤坂中心大厦11楼)
邮政编码 107-0051
电话 (03) 6384-5604 传真 (03) 6384-5608

大阪营业部
大阪市中央区今桥4丁目3番18号 (HK今桥大厦3楼)
邮政编码 541-0042
电话 (06) 6229-1960 传真 (06) 6229-1965

外营业统辖部

海外事业推进部
名古屋市西区牛岛町6番1号 (名古屋朗讯大厦17楼)
邮政编码 451-6025
电话 (052) 582-6224 传真 (052) 582-6272

开发营业部
东京都港区元赤坂1丁目3番13号 (赤坂中心大厦11楼)
邮政编码 107-0051
电话 (03) 6384-5609 传真 (03) 6384-5610

Global Network-Sales Office Locations-

Sumitomo Wiring Systems (U.S.A.) Inc. 「U.S.A.」 [SWS-USA]
39555 Orchard Hill Place Suite L60 Novi, MI 48375-5523 U.S.A.
TEL (1) 248-347-9450 FAX (1) 248-347-9451

SWS China Ltd. 「China」 [SWS-C]
Room 1503-1506, TowerB, City Center of Shanghai, 100 Zunyi Rd.,
Shanghai, China 200051
TEL (86) 21-2028-6588 FAX (86) 21-2024-3251

Hong Kong Wiring Systems, Ltd. 「China」 [HKWS]
Suites 1701-06, 17th Floor, Chinachem TsuenWan Plaza,
455-457 Castle Peak Road, Tsuen Wan, N.T., HongKong
TEL (852) 2411-0806 FAX (852) 2413-6098

SWS-Korea Co., Ltd. 「Korea」 [SWS-K]
402, 8 Seongnam-daero 331beon-gil, Bundang-gu,
Seongnam-si, Gyeonggi-do, Korea 13558
TEL (82) 31-719-9710 FAX (82) 31-719-9719

SWS Sales & Marketing (Thailand) Co., Ltd. 「Thailand」 [SWS-T]
33/4 The 9th Towers, Grand Rama 9, Tower A, 15th Fl., RamaRd.,
Huaykwang, Huaykwang, Bangkok 10310 Thailand
TEL (66) 02-001-4301-9 FAX (66) 02-001-4310

SEWS-Components & Electronics Europe, KFT. 「Hungary」 [SEWS-CEKFT]
BILK Ipari Park, Europe U, 12/Building L1 Budapest 1239, Hungary
TEL (36) 1889-0500 FAX (36) 1889-0501

URL: <http://www.sws.co.jp>

X-ON Electronics

Largest Supplier of Electrical and Electronic Components

Click to view similar products for [Terminal Block Tools & Accessories](#) category:

Click to view products by [SUMITOMO](#) manufacturer:

Other Similar products are found below :

[1029563](#) [00171430102](#) [00171420102](#) [014415](#) [CSTSPC1-2](#) [9-1437653-4](#) [928358-1](#) [QC209/J](#) [HCL10-6](#) [1437403-6](#) [1437403-9](#) [1437403-8](#)
[147832-1](#) [EC0037-000](#) [MT2/H--](#) [MT2/H-32](#) [MT6/H-N](#) [MT6/V-GRND](#) [MT8/H-101-110](#) [BB2-09BF](#) [EP2.5/4UN/BG](#) [1707755](#) [1735590](#)
[1755480](#) [1760336](#) [BO3-02](#) [1789281](#) [1840227](#) [1840230](#) [1893164](#) [2-1437402-1](#) [2-1437644-9](#) [JB2-09/J](#) [2202307](#) [2302463](#) [2305949](#) [2310581](#)
[8TK2-24](#) [91.201.1](#) [L2U2](#) [2778.0](#) [2890137](#) [2901107](#) [2901123](#) [2901699](#) [2MP/J](#) [2MV-06](#) [1705126](#) [1756294](#) [F03-25](#)