

## 1MHz, Rail-to-Rail I/O CMOS Operational Amplifiers

### FEATURES

- RAIL-TO-RAIL INPUT/OUTPUT
- HIGH SLEW RATE: 1V/ $\mu$ s
- LOW INPUT BIAS CURRENT: 1pA typ at 25°C
- GAIN BANDWIDTH PRODUCT: 1 MHz
- LOW OFFSET VOLTAGE DRIFT: 3 $\mu$ V/ $^{\circ}$ C typ
- LOW POWER CONSUMPTION: 90 $\mu$ A per amplifier at 5 V
- LOW SUPPLY VOLTAGE: 2.5 V ~ 5.5 V (25°C)
- EXTENDED TEMPERATURE: -40°C to +125°C

### APPLICATIONS

- BATTERY-POWERED APPLICATIONS
- PORTABLE DEVICES
- SIGNAL CONDITIONING
- ACTIVE FILTERING
- CURRENT SENSOR AMPLIFIER
- WEIGHT SCALE SENSOR
- MEDICAL/ INDUSTRIAL INSTRUMENTATION
- INSTRUMENTATION

### PIN ASSIGNMENTS

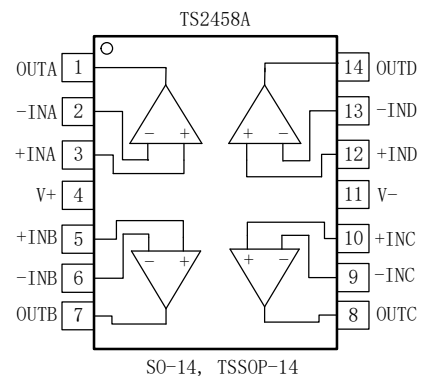
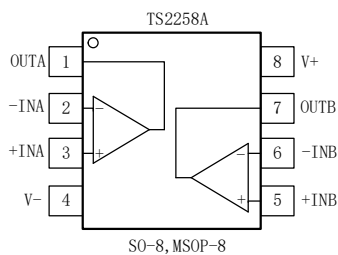
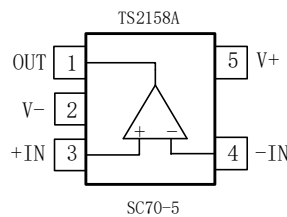
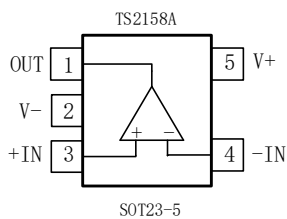

### GENERAL DESCRIPTION

TS2158A/TS2258A/TS2458A are the most cost-effective amplifiers for low voltage, low power consumption and low-cost applications. The rail-to-rail output and rail-to-rail inputs that exceed power supply range make the TS2158A series easy to use for very low voltage supply applications.

Low  $I_B$  feature of these amplifiers allows the parts to be ideal for many sensor applications. 1MHz GBW and 1V/ $\mu$ s slew rate under low power supply voltage can meet almost all sensor requirement.

Small Packages:

TS2158A in a SOT23-5 and SC70-5

TS2258A in a SO8 and MSOP8

TS2458A in a SO14 and TSSOP14

## ORDERING INFORMATION

Model	Part Number	Eco Plan	Package	AMP	Container, Pack Qty
TS2158A	TS2158ASOT235R	Rohs	SOT23-5	1	Reel, 3000
TS2158A	TS2158ASC705R	Rohs	SC70-5	1	Reel, 2500
TS2258A	TS2258ASO8R	Rohs	SO-8	2	Reel, 2500
TS2258A	TS2258AMSOP8R	Rohs	MSOP-8	2	Reel, 2500
TS2458A	TS2458ASO14R	Rohs	SO-14	4	Reel, 2500
TS2458A	TS2458ATSSOP14R	Rohs	TSSOP-14	4	Reel, 2500

## ABSOLUTE MAXIMUM RATINGS

Parameter	Min	Max	Unit
Supply Voltage		7.0	V
Signal Input Terminal Voltage	(V-) - 0.5	(V+) + 0.5	V
Operating Temperature	-50	150	°C
Junction Temperature		150	°C
Storage Temperature	-65	150	°C
Lead Temperature (Soldering, 10s)		260	°C
ESD HBM		±3000	V
ESD MM		±400	V
ESC CDM		±1000	V

## ESD CAUTION



ESD (Electrostatic Discharge) sensitive device. Charged devices and circuit boards can discharge without detection. Although this product features patented or proprietary protection circuitry, damage may occur on devices subjects to high energy ESD. Therefore, proper ESD precautions should be taken to avoid performance degradation or loss of functionality.

## ELECTRICAL CHARACTERISTICS

$V_S = +2.5V$  to  $+5.5V$ , at  $T_A = +25^\circ C$ ,  $R_L = 100k\Omega$  connected to  $V_S/2$ , and  $V_{OUT} = V_S/2$ , unless otherwise noted.  
**Boldface** limits apply over the specified temperature range,  $T_A = -40^\circ C$  to  $+125^\circ C$ .

Symbol	Parameter	Operating Conditions	Min	Typ	Max	Unit
<b>Input Characteristics</b>						
$V_{OS}$ <b>dV<sub>OS</sub>/dT</b>	Input Offset Voltage <b>Drift</b>	$V_S = 5V$		1 <b>3</b>	3.5	mV <b><math>\mu V/^\circ C</math></b>
CMRR	Common Mode Rejection Ratio $T_A = -40^\circ C$ to $+125^\circ C$  $T_A = -40^\circ C$ to $+125^\circ C$	$(V_-) - 0.2V < V_{CM} < (V_+) - 2V$  <b><math>(V_-) - 0.2V &lt; V_{CM} &lt; (V_+) - 2V</math></b> $V_S = 5.5V, (V_-) - 0.2V < V_{CM} < (V_+) + 0.2V$ <b><math>V_S = 5.5V, (V_-) - 0.2V &lt; V_{CM} &lt; (V_+) + 0.2V</math></b>	73  <b>65</b> 60 <b>56</b>	87  72		dB  <b>dB</b> dB <b>dB</b>
$I_B$ $I_{OS}$	Input Bias Current Input Offset Current			1 1		pA pA
PSRR	Power Supply Rejection Ratio $T_A = -40^\circ C$ to $+125^\circ C$	$V_S = 2.5V$ to $V_S = 5.5V, V_{CM} < (V_+) - 2V$	75  <b>68</b>	90		dB  <b>dB</b>
$A_{OL}$	Open-Loop Gain $T_A = -40^\circ C$ to $+125^\circ C$ Open-Loop Gain $T_A = -40^\circ C$ to $+125^\circ C$	$V_S = 5V, R_L = 5k\Omega, 0.125V < V_O < 4.875V$ <b><math>V_S = 5V, R_L = 5k\Omega, 0.125V &lt; V_O &lt; 4.875V</math></b> $V_S = 5V, R_L = 100k\Omega, 0.025V < V_O < 4.975V$ <b><math>V_S = 5V, R_L = 100k\Omega, 0.025V &lt; V_O &lt; 4.975V</math></b>	96  <b>70</b> 101 <b>76</b>	102  110		dB  <b>dB</b> dB <b>dB</b>
<b>Output Characteristics</b>						
	Output Voltage Swing from Rail	$R_L = 100k\Omega$		10		mV
$R_{OUT}$	Open-Loop Output Impedance	$f = 1MHz, I_o = 0$		280		$\Omega$
<b>Frequency Domain Response</b>						
GBW	Gain Bandwidth Product			1		MHz
$t_s$	Settling Time to 0.1%	$V_{OUT} = 2V$ step; $G = +1$		3		$\mu s$
	Overload recovery time	$V_{in} * Gain > V_S$		1		$\mu s$
SR	Slew Rate	$G = +1$		1		V/ $\mu s$
<b>Distortion/Noise Response</b>						
THD+N	Total Harmonic Distortion+ Noise	$V_S = 5V, V_o = 3V_{pp}, G = +1, f = 1kHz$		TBD		%
$e_n$	Input Voltage Noise Density	$f = 10kHz$		40		nV/ $\sqrt{Hz}$
$V_{NOISE}$	Input Voltage Noise	$f = 0.1Hz$ to $10Hz$		6.5		$\mu V_{pp}$
<b>Power Supply</b>						
$V_S$	Specified Voltage Range		2.5		5.5	V
	Operating Voltage Range		2.2		5.5	V
$I_S$	Supply Current	$I_o = 0, V_S = 5V$		90	132	$\mu A$
<b>Temperature Range</b>						
$\theta_{JA}$	Specified Range Thermal Resistance SO-8		-40		125	$^\circ C$
				150		$^\circ C/W$

**TYPICAL CHARACTERISTICS**

At  $T_A = +25^\circ\text{C}$ ,  $R_L = 10\text{k}\Omega$  connected to  $V_S/2$ , and  $V_{OUT} = V_S/2$ , unless otherwise noted.

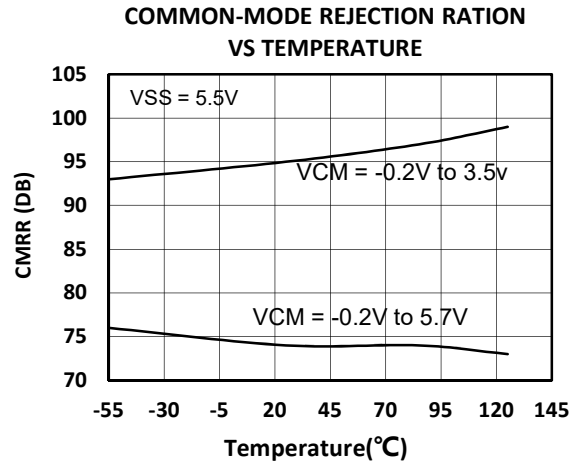
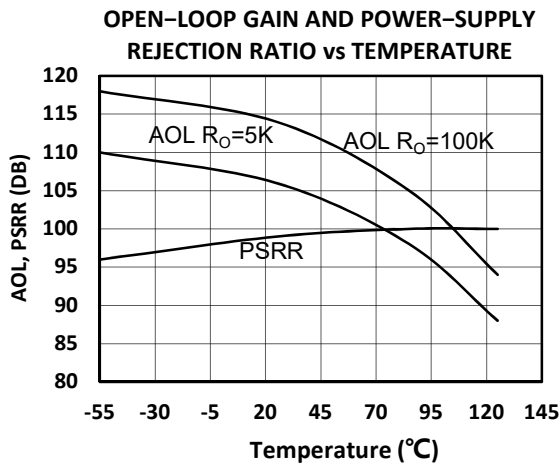
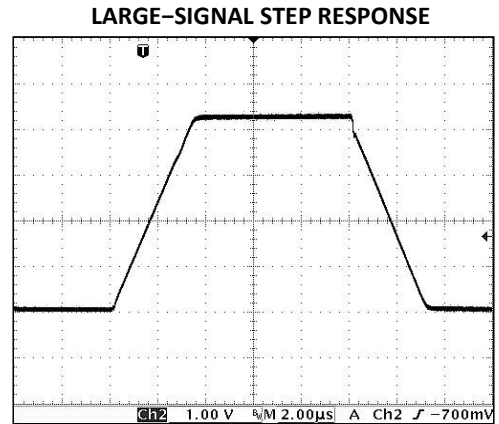
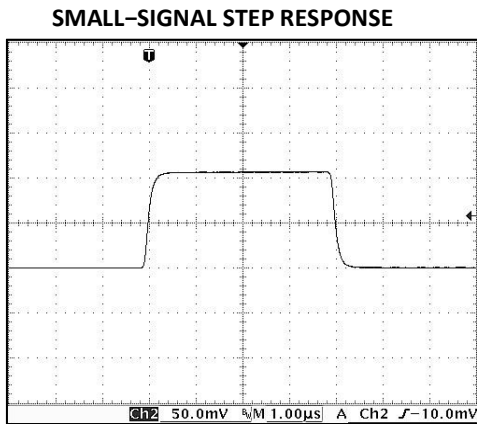
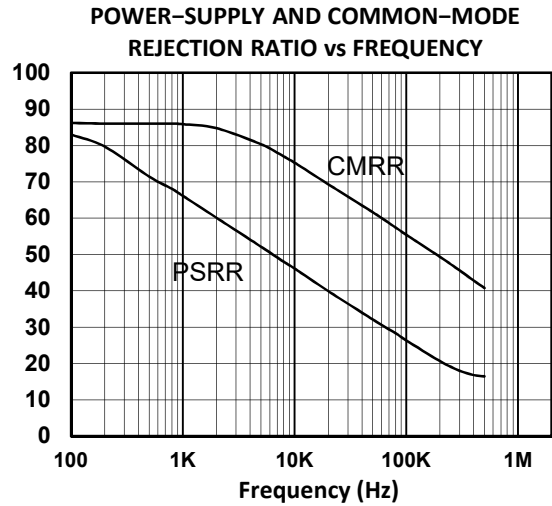
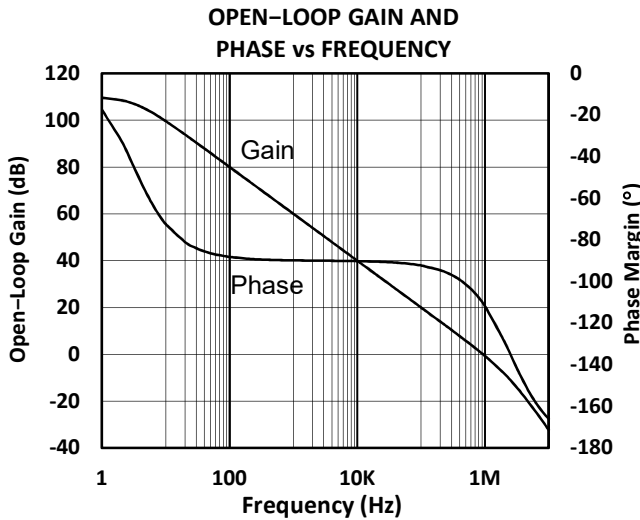

## TYPICAL CHARACTERISTICS

At  $T_A = +25^\circ\text{C}$ ,  $R_L = 10\text{k}\Omega$  connected to  $V_s/2$ , and  $V_{OUT} = V_s/2$ , unless otherwise noted.

QUIESCENT CURRENT VS TEMPERATURE

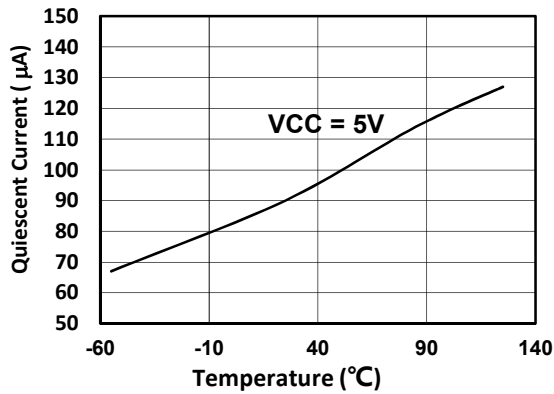

INPUT VOLTAGE NOISE  
SPECTRAL DENSITY VS FREQUENCY

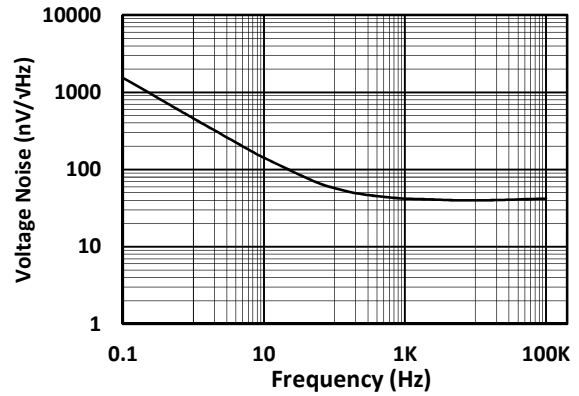

QUIESCENT CURRENT VS  
SUPPLY VOLTAGE

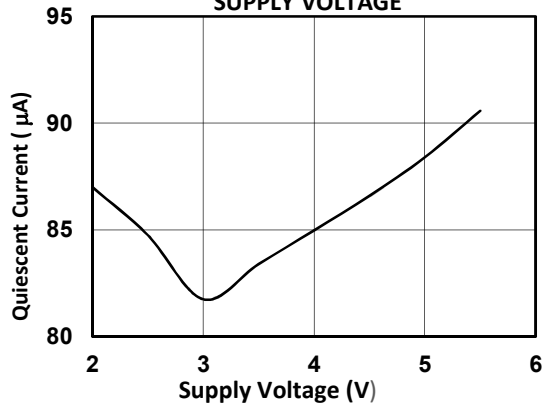

CONTINUOUS SHORT-CIRCUIT CURRENT  
VS POWER-SUPPLY VOLTAGE

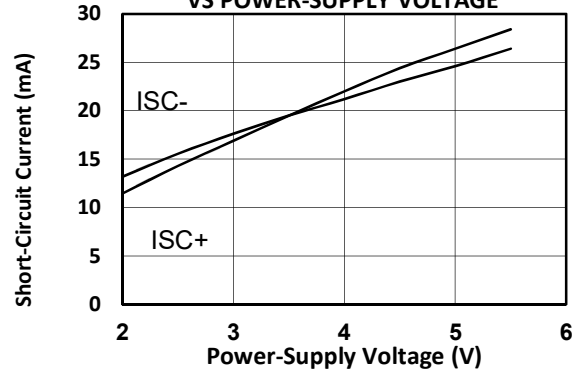

0.1 TO 10HZ NOISE

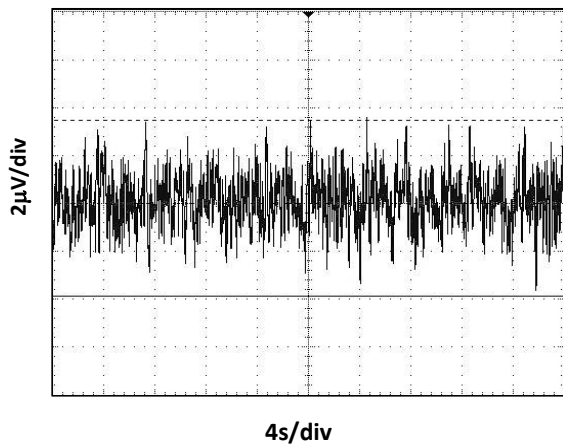

OUTPUT VOLTAGE SWING  
VS OUTPUT CURRENT

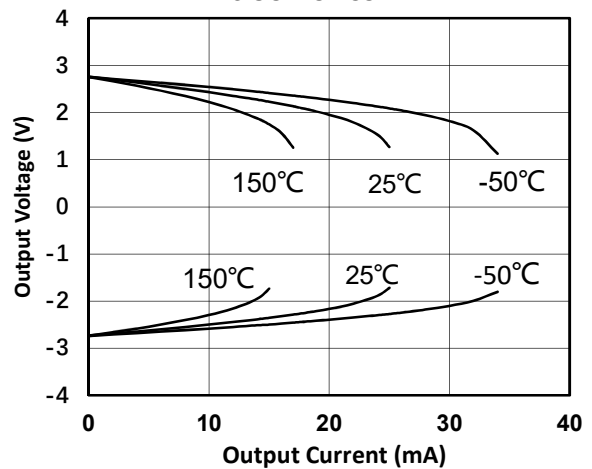

**TYPICAL CHARACTERISTICS**

At  $T_A = +25^\circ\text{C}$ ,  $R_L = 10\text{k}\Omega$  connected to  $V_S/2$ , and  $V_{OUT} = V_S/2$ , unless otherwise noted.

**Offset Voltage Production Distribution**

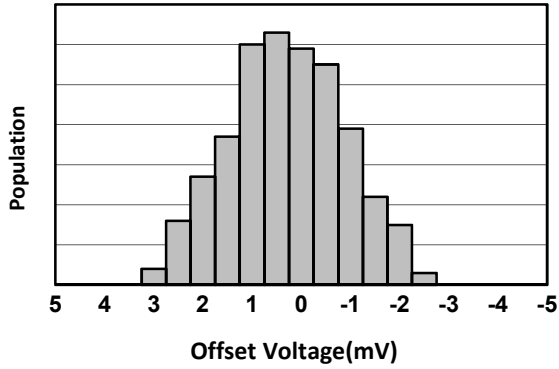

**Offset Voltage Drift Magnitude Production Distribution**

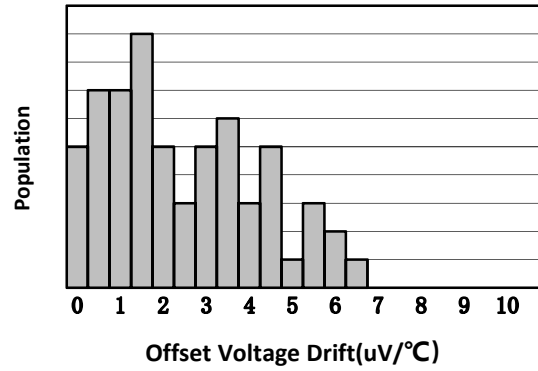

**SHORT-CIRCUIT CURRENT VS TEMPERATURE**

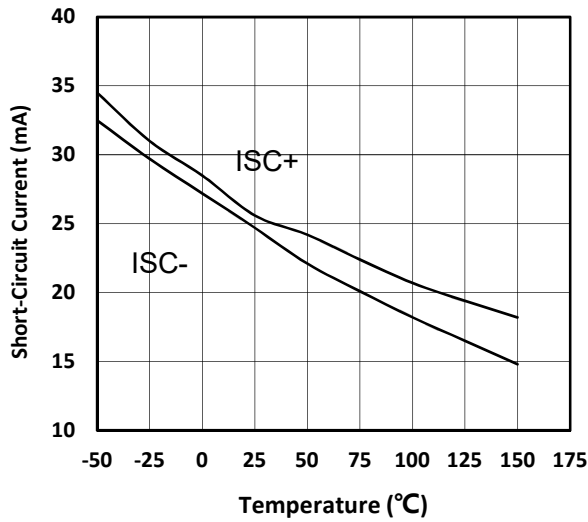

## MECHANICAL DIMENSIONS

### SOT23-5 PACKAGE MECHANICAL DRAWING

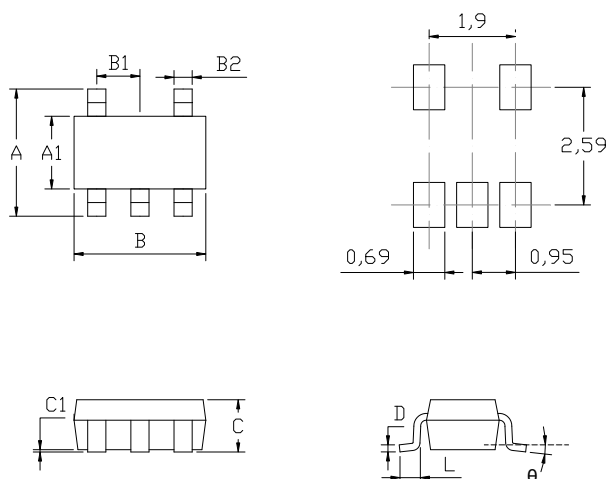

### SOT23-5 PACKAGE MECHANICAL SPECIFICATIONS

symbol	dimensions			
	millimeters		inches	
	min	max	min	max
A	2.6	3	0.1024	0.1181
A1	1.45	1.75	0.0571	0.0689
B	2.75	3.05	0.1083	0.1201
B1	0.95		0.0374	
B2	0.3	0.5	0.0118	0.0197
C		1.45MAX		0.0571MAX
C1	0	0.15	0.0000	0.0059
L	0.3	0.5	0.0118	0.0197
D	0.08	0.22	0.0031	0.0087
$\theta$	0°	8°	0°	8°

**SC70-5 PACKAGE MECHANICAL DRAWING**

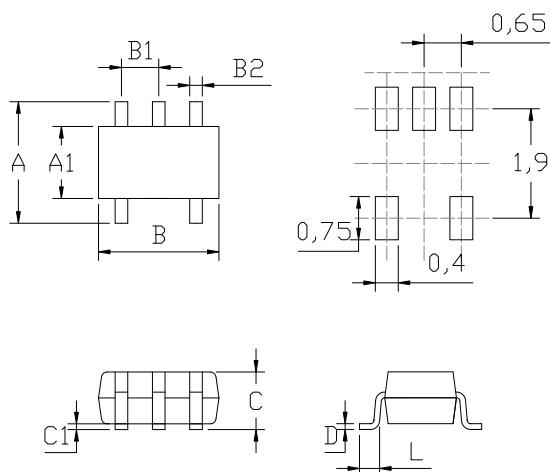

**SC70-5 PACKAGE MECHANICAL SPECIFICATIONS**

symbol	dimensions			
	millimeters		inches	
	min	max	min	max
A	1.8	2.4	0.0709	0.0945
A1	1.1	1.4	0.0433	0.0551
B	2.15	1.85	0.0846	0.0728
B1	0.95		0.0374	
B2	0.15	0.3	0.0059	0.0118
C		1.1MAX		0.0433MAX
C1	0	0.10	0.0000	0.0039
L	0.26	0.46	0.0102	0.0181
D	0.08	0.22	0.0031	0.0087
θ	0°	8°	0°	8°



**MSOP-8 PACKAGE MECHANICAL DRAWING**

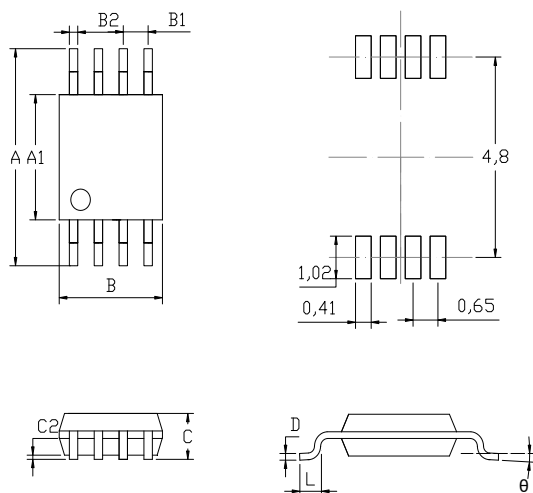

**MSOP-8 PACKAGE MECHANICAL SPECIFICATIONS**

symbol	dimensions			
	millimeters		inches	
	min	max	min	max
A	4.75	5.05	0.1870	0.1988
A1	2.9	3.1	0.1142	0.1220
B	2.9	3.1	0.1142	0.1220
B1	0.65		0.0197	
B2	0.17	0.3	0.0067	0.0106
C		1.10MAX		0.0433
C1	0.05	0.15	0.0020	0.0059
L	0.4	0.7	0.0157	0.0276
D	0.13	0.23	0.0051	0.0091
θ	0°	8°	0°	8°

**TSSOP-14 PACKAGE MECHANICAL DRAWING**

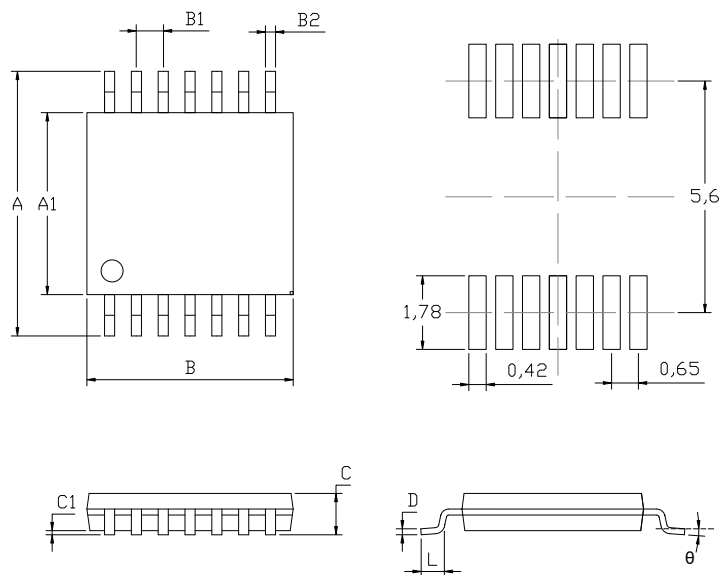

**TSSOP-14 PACKAGE MECHANICAL SPECIFICATIONS**

symbol	dimensions			
	millimeters		inches	
	min	max	min	max
A	6.2	6.6	0.2441	0.2598
A1	4.3	4.5	0.1693	0.1772
B	4.9	5.1	0.1929	0.2008
B1	0.65		0.0256	
B2	0.19	0.3	0.0075	0.0118
C		1.20MAX		0.0472MAX
C1	0.05	0.15	0.0020	0.0059
L	0.5	0.75	0.0197	0.0295
D	0.1	0.2	0.0039	0.0079
θ	0°	8°	0°	8°

**SO-8 PACKAGE MECHANICAL DRAWING**

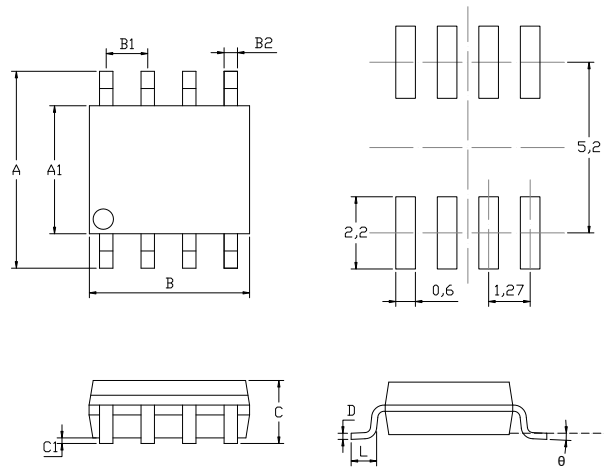

**SO-8 PACKAGE MECHANICAL SPECIFICATIONS**

symbol	dimensions			
	millimeters		inches	
	min	max	min	max
A	5.8	6.2	0.2283	0.2441
A1	3.8	4	0.1496	0.1575
B	4.8	5	0.1890	0.1969
B1	1.27		0.0500	
B2	0.31	0.51	0.0122	0.0201
C		1.75MAX		0.0689MAX
C1	0.1	0.25	0.0039	0.0098
L	0.4	1.27	0.0157	0.0500
D	0.13	0.25	0.0051	0.0098
theta	0°	8°	0°	8°

**SO-14 PACKAGE MECHANICAL DRAWING**

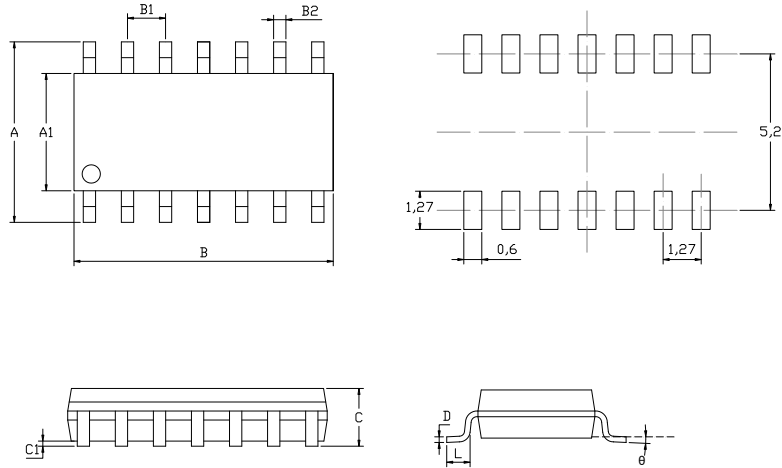

**SO-14 PACKAGE MECHANICAL SPECIFICATIONS**

symbol	dimensions			
	millimeters		inches	
	min	max	min	max
A	6.2	5.8	0.2441	0.2283
A1	3.8	4	0.1496	0.1575
B	8.55	8.75	0.3366	0.3445
B1	1.27		0.0500	
B2	0.31	0.51	0.0122	0.0201
C	1.75MAX			0.0689
C1	0.1	0.25	0.0039	0.0098
L	0.4	1.27	0.0157	0.0500
D	0.13	0.25	0.0051	0.0098
θ	0°	8°	0°	8°

## CONTACT INFORMATION

### Trusignal Microelectronics

Phone: +86 512-65923982

Fax: +86 512-65923995

Email: [sales@kunyuanic.com](mailto:sales@kunyuanic.com)

[support@kunyuanic.com](mailto:support@kunyuanic.com)

## X-ON Electronics

Largest Supplier of Electrical and Electronic Components

*Click to view similar products for [Operational Amplifiers - Op Amps](#) category:*

*Click to view products by [Trusignal Microelec](#) manufacturer:*

Other Similar products are found below :

[OPA2991IDSGR](#) [OPA607IDCKT](#) [007614D](#) [633773R](#) [635798C](#) [635801A](#) [702115D](#) [709228FB](#) [741528D](#) [NCV33072ADR2G](#)  
[SC2902DTBR2G](#) [SC2903DR2G](#) [SC2903VDR2G](#) [LM258AYDT](#) [LM358SNG](#) [430227FB](#) [430228DB](#) [460932C](#) [AZV831KTR-G1](#) [409256CB](#)  
[430232AB](#) [LM2904DR2GH](#) [LM358YDT](#) [LT1678IS8](#) [042225DB](#) [058184EB](#) [070530X](#) [SC224DR2G](#) [SC239DR2G](#) [SC2902DG](#)  
[SCYA5230DR2G](#) [714228XB](#) [714846BB](#) [873836HB](#) [MIC918YC5-TR](#) [TS912BIYDT](#) [NCS2004MUTAG](#) [NCV33202DMR2G](#)  
[M38510/13101BPA](#) [NTE925](#) [SC2904DR2G](#) [SC358DR2G](#) [LM358EDR2G](#) [AZV358MTR-G1](#) [AP4310AUMTR-AG1](#) [HA1630D02MMEL-E](#)  
[NJM358CG-TE2](#) [HA1630S01LPEL-E](#) [LM324AWPT](#) [HA1630Q06TELL-E](#)