

Features

- Ultra low leakage: nA level
- Operating voltage: 3.3V
- Low clamping voltage
- Complies with following standards:
 - IEC 61000-4-2 (ESD) immunity test
 - Air discharge: $\pm 15\text{kV}$
 - Contact discharge: $\pm 8\text{kV}$
 - IEC61000-4-4 (EFT) 40A (5/50ns)
 - IEC61000-4-5 (Lightning) 3A (8/20 μs)
- RoHS Compliant

Dimensions SOT-353

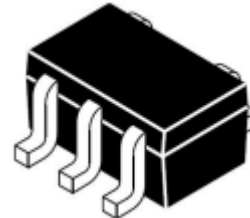

Pin Configuration

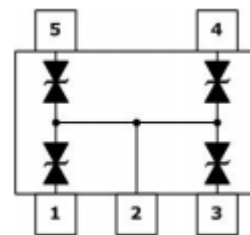

Applications

- USB 2.0 power and data line
- Set-top box and digital TV
- Digital video interface (DVI)
- Notebook Computers
- SIM Ports
- 10/100 Ethernet

Mechanical Characteristics

- Package: SOT-353
- Lead Finish: Lead Free
- UL Flammability Classification Rating 94V-0
- Quantity Per Reel: 3,000pcs
- Reel Size: 7inch

Absolute Maximum Ratings (T_{amb}=25°C unless otherwise specified)

Parameter	Symbol	Value	Unit
Peak Pulse Power (8/20 μs)	P _{pp}	100	W
ESD per IEC 61000-4-2 (Air)	V _{ESD}	± 15	Kv
ESD per IEC 61000-4-2 (Contact)		± 8	
Operating Temperature Range	T _J	-55 to +125	°C
Storage Temperature Range	T _{STJ}	-55 to +150	°C

Electrical Characteristics (TA=25°C unless otherwise specified)

Part Number	Device Marking	V _{RWM} (V)	V _{BR} (V)	I _T (mA)	V _C @1A	V _C		I _R μA (Max)	C (Pf) (Typ.)
						(Max)	(@A)		
ESDA3.3CW-4	W3	3.3	4.5	1	7.5	10	2.5	10	13

Characteristic Curves

Fig1. 8/20μs Pulse Waveform

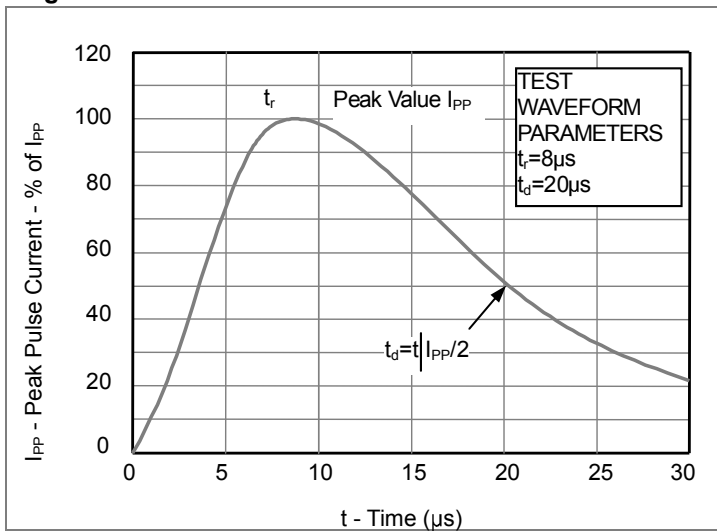

Fig2. ESD Pulse Waveform (according to IEC 61000-4-2)

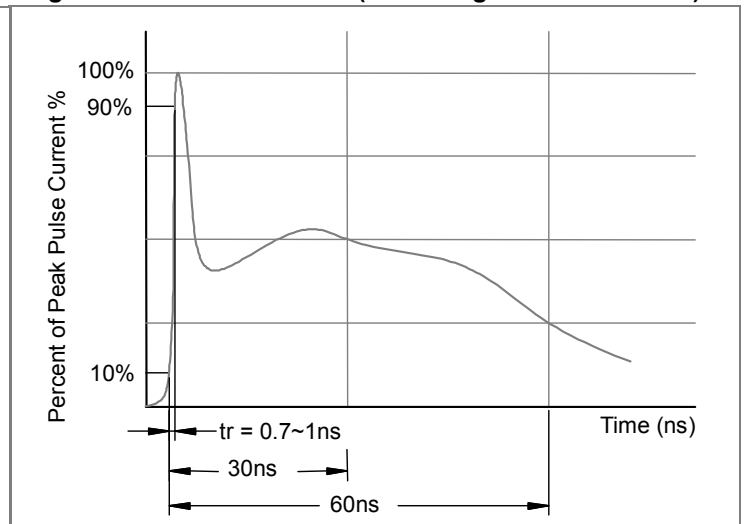
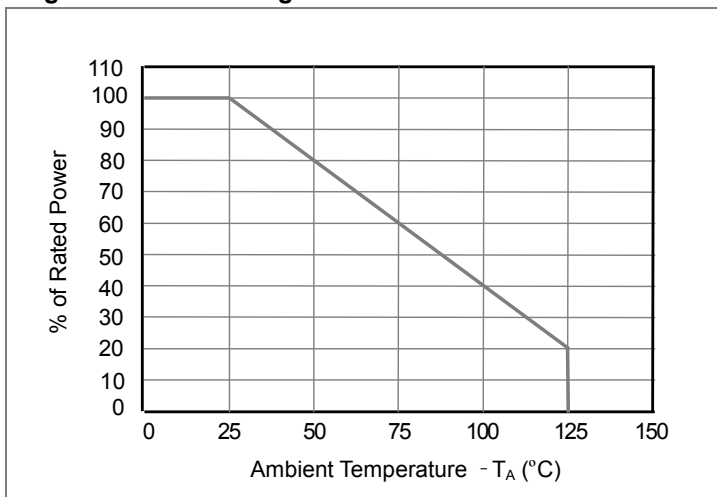
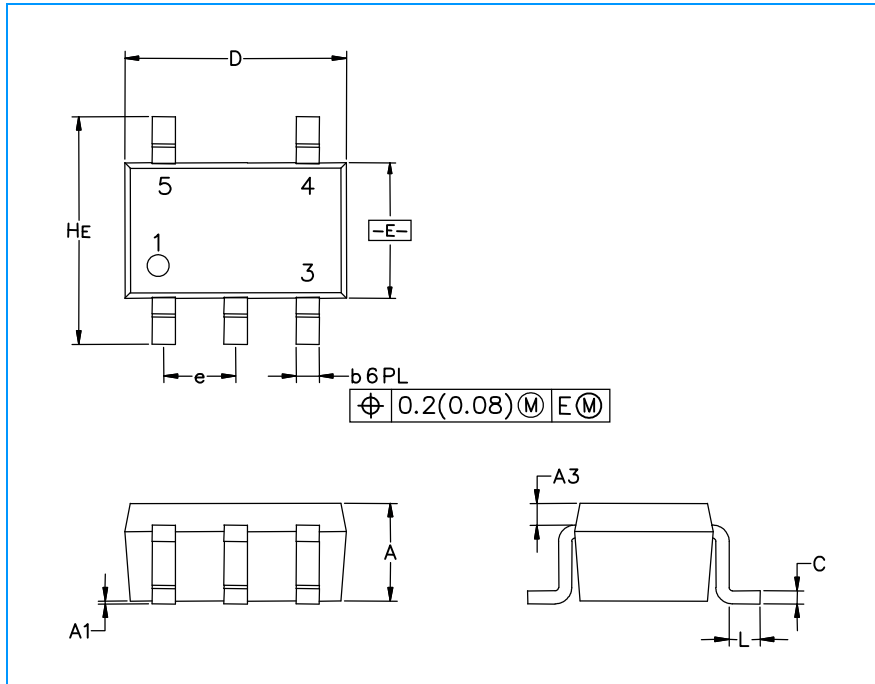

Fig3. Power Derating Curve



SOT-353 Package Outline & Dimensions



Symbol	Inches			Millimeters		
	Min.	Nom.	Max.	Min.	Nom.	Max.
A	0.031	0.037	0.043	0.80	0.95	1.10
A1	0.000	0.002	0.004	0.00	0.05	0.10
A3	0.08 REF			0.2 REF		
b	0.004	0.008	0.012	0.10	0.21	0.30
C	0.004	0.005	0.010	0.10	0.14	0.25
D	0.070	0.078	0.086	1.80	2.00	2.20
E	0.045	0.049	0.053	1.15	1.25	1.35
e	0.026 BSC			0.65 BSC		
L	0.004	0.008	0.012	0.10	0.20	0.30
HE	0.078	0.082	0.086	2.00	2.10	2.20

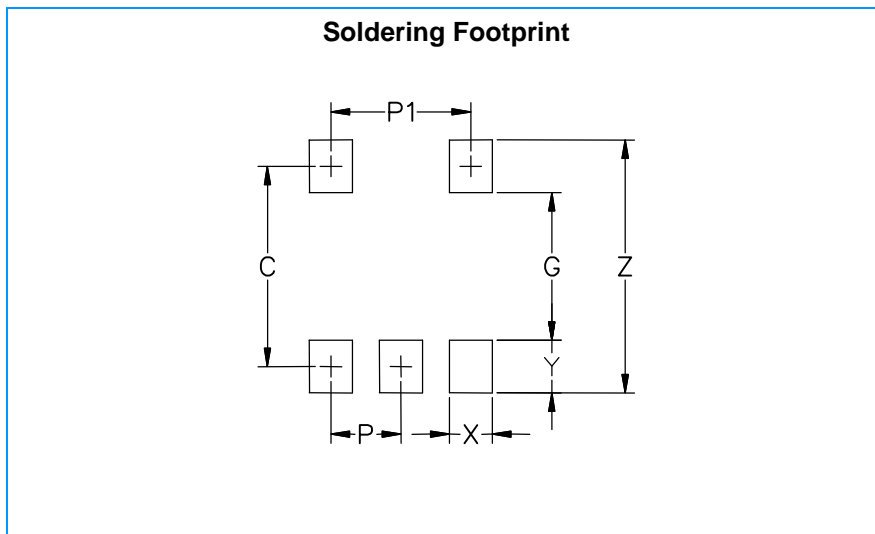

Symbol	Inches	Millimeters
C	0.0748	1.9
G	0.055	1.40
P	0.025	0.65
P1	0.051	1.30
X	0.0157	0.40
Y	0.019	0.50
Z	0.0945	2.4

X-ON Electronics

Largest Supplier of Electrical and Electronic Components

Click to view similar products for [ESD Suppressors / TVS Diodes](#) category:

Click to view products by [Leiditech](#) manufacturer:

Other Similar products are found below :

[NTE4902](#) [P4SMAJ15A](#) [P4SMAJ26A](#) [SMAJ400CA-TP](#) [TGL34-47CA](#) [ESDAULC45-1BF4](#) [SM1605E3/TR13](#) [SMF20A-TP](#) [P4SMAJ12A](#)
[CPDUR24V-HF](#) [CPDQC5V0USP-HF](#) [CPDQC5V0-HF](#) [MPLAD30KP45CAE3](#) [MMBZ27VCLQ-7-F](#) [MMAD1108/TR13](#) [MPLAD30KP24A](#)
[ACPDQC5V0R-HF](#) [DFLT170A-7](#) [NTE4900](#) [NTE4926](#) [NTE4938](#) [SMF22A-TP](#) [SMF12A-TP](#) [SLVU2.8-TP](#) [SMLJ6.5CA-TP](#) [SMAJ6.5CA-](#)
[TP](#) [MMAD1108E3/TR13](#) [D5V0M1U2LP3-7](#) [SMAJ400A-TP](#) [AOZ8811DT-03](#) [AOZ8831DI-05](#) [AOZ8831DT-03](#) [SMAJ188CA](#) [3SMC33CA](#)
[BK](#) [CPDQC3V3C-HF](#) [CPDQC12VE-HF](#) [MPLAD30KP170CA](#) [82357120100](#) [5.0SMLJ15CA-TP](#) [5KP18A-TP](#) [P6KE8.2A-TP](#)
[MPLAD30KP43CAE3](#) [SMAJ43A-TP](#) [D5V0F6U8LP33-7](#) [TVS5501V10MUT5G](#) [5.0SMLJ24CA-TP](#) [SMAJ110CA-TP](#) [MPLAD15KP75CAE3](#)
[MMAD1103e3/TR13](#) [DFLT40AQ-7](#)