

Features

- ◆ The plastic package carries Underwriters Laboratory Flammability Classification 94V-0
- ◆ For surface mounted applications
- ◆ Built-in strain relief, ideal for automated placement
- ◆ Low reverse leakage
- ◆ High forward surge current capability
- ◆ High temperature soldering guaranteed
250°C/10 seconds at terminals

Mechanical Data

Case : Molded plastic body

Terminals : Solder plated, solderable per MIL-STD-750, Method 2026

Polarity : Polarity symbol marking on body

Mounting Position : Any

Weight : 0.0023 ounce, 0.07 grams

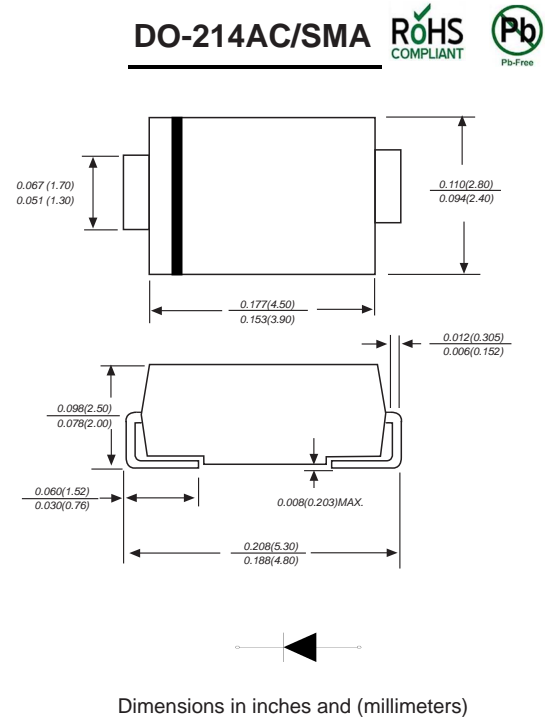

Maximum Ratings And Electrical Characteristics

Ratings at 25°C ambient temperature unless otherwise specified. Single phase half-wave 60Hz, resistive or inductive load, for capacitive load current derate by 20%.

Parameter	SYMBOLS	SS12	SS14	SS145	SS16	SS18	SS110	SS115	SS120	UNITS
Maximum repetitive peak reverse voltage	V_{RRM}	20	40	45	60	80	100	150	200	V
Maximum RMS voltage	V_{RMS}	14	28	31.5	42	56	70	105	140	V
Maximum DC blocking voltage	V_{DC}	20	40	45	60	80	100	150	200	V
Maximum average forward rectified current at $T_L=100^\circ\text{C}$	$I_{(AV)}$	1.0								A
Peak forward surge current, 8.3ms single half sine-wave superimposed on rated load	I_{FSM}	30.0								A
Maximum instantaneous forward voltage at 1.0A	V_F	0.55		0.70	0.85		0.95		V	
Maximum DC reverse current at rated DC blocking voltage $T_A=25^\circ\text{C}$ $T_A=125^\circ\text{C}$	I_R	0.5 50			0.05 10				mA	
Typical thermal resistance	R_{qJA}	80.0								°C/W
Operating junction temperature range	T_J	-55 to +125				-55 to +150				°C
Storage temperature range	T_{STG}	-55 to +150								°C

Ratings And Characteristic Curves

FIG. 1- DERATING CURVE OUTPUT RECTIFIED CURRENT

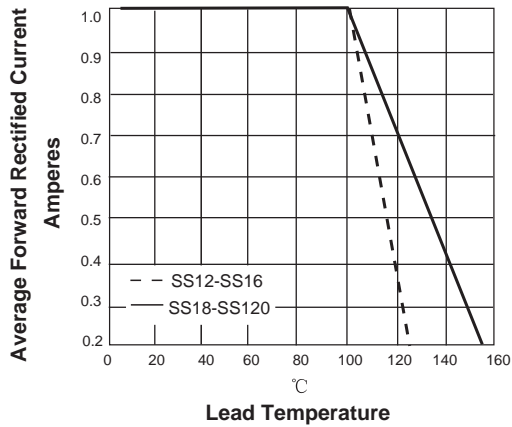

FIG. 2-MAXIMUM NON-REPETITIVE PEAK FORWARD SURGE CURRENT PERLEG

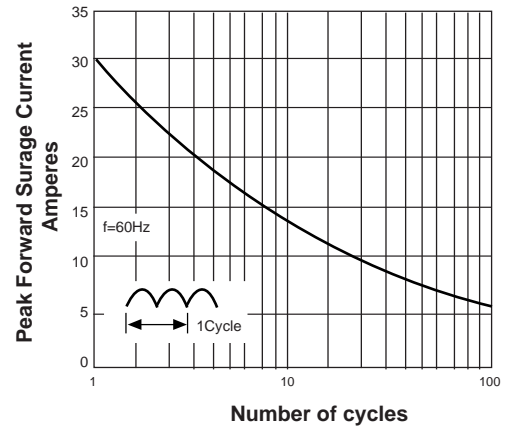

FIG. 3-TYPICAL FORWARD VOLTAGE CHARACTERISTICS

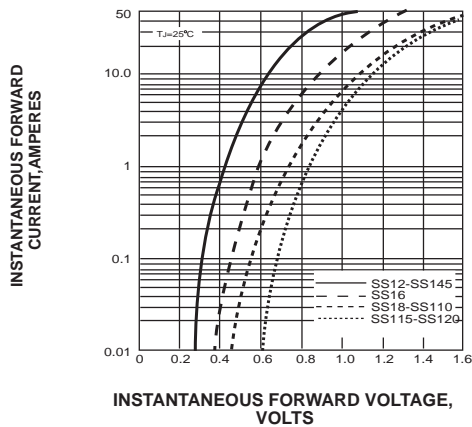
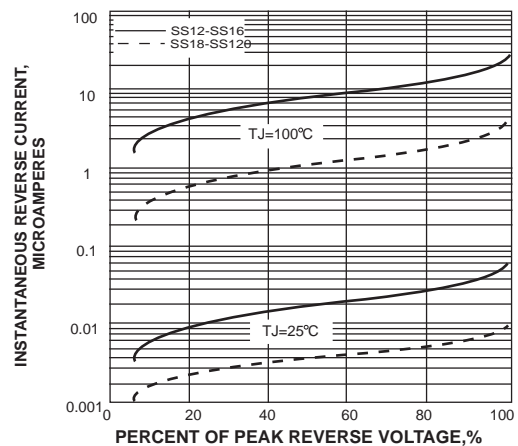
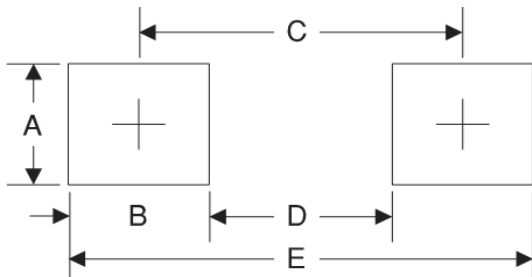

FIG. 4-TYPICAL REVERSE LEAKAGE CHARACTERISTICS



Suggested Pad Layout



Symbol	Unit (mm)	Unit (inch)
A	1.68	0.066
B	1.52	0.060
C	3.90	0.154
D	2.41	0.095
E	5.45	0.215

Suggested Soldering Temperature Profile

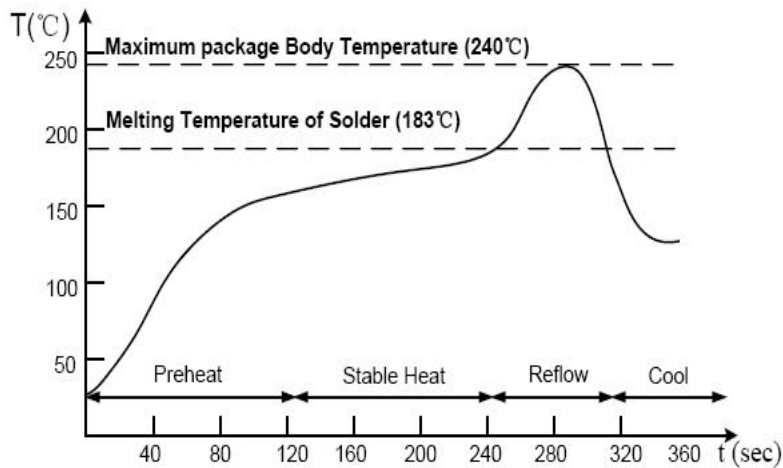

Note

- Recommended reflow methods: IR, vapor phase oven, hot air oven, wave solder.
- The device can be exposed to a maximum temperature of 265°C for 10 seconds.
- Devices can be cleaned using standard industry methods and solvents.
- If reflow temperatures exceed the recommended profile, devices may not meet the performance requirements.

Package Information

Carrier Dimension(mm)

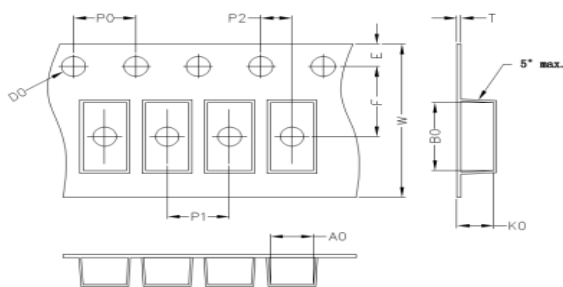

A0	B0	K0	D0	E	F
2.80	5.30	2.36	1.55	1.75	5.50
P0	P1	P2	T	W	Tolerance
4.0	4.0	2.0	0.25	12	0.1

Package Specifications

Package	Reel Size	Reel DIA. (mm)	Q'TY/Reel (Kpcs)	Box Size (mm)	QTY/Box (Kpcs)	Carton Size (mm)	Q'TY/Carton (Kpcs)
SMA	11'	278	5	285	10	355*310*310	80
	13'	330	7.5	340	15	360*360*360	120

X-ON Electronics

Largest Supplier of Electrical and Electronic Components

Click to view similar products for [Schottky Diodes & Rectifiers](#) category:

Click to view products by [Yenji](#) manufacturer:

Other Similar products are found below :

[CUS06\(TE85L,Q,M\)](#) [MA4E2039](#) [D1FH3-5063](#) [MBR0530L-TP](#) [MBR10100CT-BP](#) [MBR30H100MFST1G](#) [MMBD301M3T5G](#) [PMAD1103-LF](#) [PMAD1108-LF](#) [RB160M-50TR](#) [RB520S-30](#) [RB551V-30](#) [DD350N18K](#) [DZ435N40K](#) [DZ600N16K](#) [BAS16E6433HTMA1](#) [BAS 3010S-02LRH E6327](#) [BAT 54-02LRH E6327](#) [IDL02G65C5XUMA1](#) [NSR05F40QNXT5G](#) [NSVR05F40NXT5G](#) [JANS1N6640](#) [SB07-03C-TB-H](#) [SB1003M3-TL-W](#) [SBAT54CWT1G](#) [SBM30-03-TR-E](#) [SBS818-TL-E](#) [SK32A-LTP](#) [SK33A-TP](#) [SK34A-TP](#) [SK34B-TP](#) [SMD1200PL-TP](#) [ACDBN160-HF](#) [SS3003CH-TL-E](#) [STPS30S45CW](#) [PDS3100Q-7](#) [GA01SHT18](#) [CRS10I30A\(TE85L,QM\)](#) [MBR1240MFST1G](#) [MBRB30H30CT-1G](#) [BAS28E6433HTMA1](#) [BAS 70-02L E6327](#) [HSB123JTR-E](#) [JANTX1N5712-1](#) [VS-STPS40L45CW-N3](#) [DD350N12K](#) [SB007-03C-TB-E](#) [SB10015M-TL-E](#) [SB1003M3-TL-E](#) [SK110-LTP](#)