

Metal Oxide Varistors-Q Series (6KV/3KA) Data Sheet

Feature

- Wide operating voltage range from 82V to 1100V
- Operating Temperature: -40°C ~ +125°C
- Storage Temperature: 15°C ~ 35°C

Applications

- The over-voltage protection for transistors, IC, SCR and semiconductor switching components and a variety of electronic, electrical equipment
- Surge absorption and over-voltage protection for household appliances
- Industrial electrical surge absorption
- Electrostatic discharge and noise signal cancellation
- Surge absorption of relays and solenoid valves
- Over-voltage protection for leakage switch
- The lightning protection and over-voltage protection for Telephone program-controlled switches and communications equipment

Applicable Standard

| Approval | | Organization | Safety Standards | Certificate No. |
|---------------|---|--------------|--|---------------------|
| China |  | CQC | GB/T10193 GB/T10194 GB8898-2011 GB4943.1-2011 | 10D: CQC07001020532 |
| | | | | 14D: CQC07001020531 |
| | | | | 20D: CQC07001020530 |
| USA Canada |  | UL | UL 1449 | E330837 |
| Germany |  | VDE | IEC 61051 | 40023049 |

Part Number Code

Inner Management

| | | | | | | | | | | | | | |
|-----|----|---|-----|---|---|---|----|---|---|---|---|---|---|
| STE | 10 | D | 471 | K | 1 | E | N0 | F | Q | B | 0 | R | 0 |
|-----|----|---|-----|---|---|---|----|---|---|---|---|---|---|

Songtian
(STE)

Product Categories
D: (Circular)

Tolerance
K:±10%

Pitch
E:7.5mm
D:10.0mm

Package
B: Bulk
T:Tape

Environmental Standard
R: RoHS
F: RoHS+Halogen-Free

Core Diameter
10:10mm
14:14mm
20:20mm

Foot Type
1:Long straight
2:Outside Crimped
3:Short Straight
8:Vertical Crimped

Style
Q: 6KV/3KA

Lead Material
F: Tinned copper clad steel wire
C:Copper wire

Nominal Varistor Voltage
820:82V
471:470V
122:1200V

Lead Length
S0~S9:1.0~1.9mm
X0~X9:2.0~2.9mm
A0~A9:3.0~3.9mm
B0~B9:4.0~4.9mm
C0~C9:5.0~5.9mm
D0~D9:6.0~6.9mm
E0~E9:7.0~7.9mm

Lead Length
F0~F9:8.0~8.9mm
G0~G9:9.0~9.9mm
H0~H9:10.0~10.9mm
J0~J9:11.0~11.9mm
K0~K9:12.0~12.9mm
L0~L9:13.0~13.9mm
M0~M9:14.0~14.9mm

Lead Length
M0~M9:14.0~14.9mm
N0:16~27.0mm(Bulk)
Crimped Lead Taped
N0:H0=16.5mm
P0:H0=17.0mm
Q0:H0=19.0mm
Straight Lead
Q0:20.0mm

Electrical Characteristics

10D-Q Series

| Part Number | Maximum Allowable Voltage | | Varistor Voltage V_{1mA} (V) | Maximum Clamping Voltage | | Peak Current Rating(8/20 μ s) | | Maximum Energy (10/1000 μ s) (J) | Rated Power (W) | Typical Capacitance (Reference) 1KHz (pF) |
|--------------|---------------------------|--------------------------|--------------------------------------|--------------------------|-----------|-----------------------------------|----------------|--|--------------------|--|
| | AC _{rms} (V) | DC _{rms} (V) | | VC (V) | IP (A) | 1 pulse (A) | 2 pulse (A) | | | |
| STE-10D391KQ | 250 | 320 | 390(351-429) | 650 | 25 | 3500 | 2500 | 81.2 | 0.4 | 300 |
| STE-10D431KQ | 275 | 350 | 430(387-473) | 710 | 25 | 3500 | 2500 | 68.2 | 0.4 | 270 |
| STE-10D471KQ | 300 | 385 | 470(423-517) | 775 | 25 | 3500 | 2500 | 99.4 | 0.4 | 230 |
| STE-10D511KQ | 320 | 415 | 510(459-561) | 845 | 25 | 3500 | 2500 | 99.4 | 0.4 | 210 |
| STE-10D561KQ | 350 | 460 | 560(504-616) | 925 | 25 | 3500 | 2500 | 99.4 | 0.4 | 180 |
| STE-10D621KQ | 385 | 505 | 620(558-682) | 1025 | 25 | 3500 | 2500 | 102.2 | 0.4 | 190 |
| STE-10D681KQ | 420 | 560 | 680(612-748) | 1120 | 25 | 3500 | 2500 | 102.2 | 0.4 | 170 |
| STE-10D751KQ | 460 | 615 | 750(675-825) | 1240 | 25 | 3500 | 2500 | 124.6 | 0.4 | 160 |
| STE-10D821KQ | 510 | 670 | 820(738-902) | 1355 | 25 | 3500 | 2500 | 124.6 | 0.4 | 140 |
| STE-10D911KQ | 550 | 745 | 910(819-1001) | 1500 | 25 | 3500 | 2500 | 133 | 0.4 | 120 |
| STE-10D102KQ | 625 | 825 | 1000(900-1100) | 1650 | 25 | 3500 | 2500 | 133 | 0.4 | 110 |
| STE-10D112KQ | 680 | 895 | 1100(990-1210) | 1815 | 25 | 3500 | 2500 | 155 | 0.4 | 90 |

14D-Q Series

| Part Number | Maximum Allowable Voltage | | Varistor Voltage V_{1mA} (V) | Maximum Clamping Voltage | | Peak Current Rating(8/20 μ s) | | Maximum Energy (10/1000 μ s) (J) | Rated Power (W) | Typical Capacitance (Reference) 1KHz (pF) |
|--------------|---------------------------|--------------------------|--------------------------------------|--------------------------|-----------|-----------------------------------|----------------|--|--------------------|--|
| | AC _{rms} (V) | DC _{rms} (V) | | VC (V) | IP (A) | 1 pulse (A) | 2 pulse (A) | | | |
| STE-14D820KQ | 50 | 65 | 82(74-90) | 135 | 50 | 6000 | 4500 | 29.4 | 0.6 | 3700 |
| STE-14D101KQ | 60 | 85 | 100(90-110) | 165 | 50 | 6000 | 4500 | 33.6 | 0.6 | 3200 |
| STE-14D121KQ | 75 | 100 | 120(108-132) | 200 | 50 | 6000 | 4500 | 40.6 | 0.6 | 2700 |
| STE-14D151KQ | 95 | 125 | 150(135-165) | 250 | 50 | 6000 | 4500 | 51.8 | 0.6 | 2200 |
| STE-14D181KQ | 115 | 150 | 180(162-198) | 300 | 50 | 6000 | 4500 | 58.8 | 0.6 | 1100 |
| STE-14D201KQ | 130 | 170 | 200(180-220) | 340 | 50 | 6000 | 4500 | 79.8 | 0.6 | 770 |
| STE-14D221KQ | 140 | 180 | 220(198-242) | 360 | 50 | 6000 | 4500 | 79.8 | 0.6 | 740 |
| STE-14D241KQ | 150 | 200 | 240(216-264) | 395 | 50 | 6000 | 4500 | 82.6 | 0.6 | 700 |
| STE-14D271KQ | 175 | 225 | 270(243-297) | 455 | 50 | 6000 | 4500 | 93.8 | 0.6 | 640 |
| STE-14D301KQ | 190 | 250 | 300(270-330) | 500 | 50 | 6000 | 4500 | 103.6 | 0.6 | 670 |
| STE-14D331KQ | 210 | 275 | 330(297-363) | 550 | 50 | 6000 | 4500 | 112 | 0.6 | 580 |
| STE-14D361KQ | 230 | 300 | 360(324-396) | 595 | 50 | 6000 | 4500 | 123.2 | 0.6 | 540 |
| STE-14D391KQ | 250 | 320 | 390(351-429) | 650 | 50 | 6000 | 4500 | 134.4 | 0.6 | 500 |
| STE-14D431KQ | 275 | 350 | 430(387-473) | 710 | 50 | 6000 | 4500 | 145.6 | 0.6 | 450 |
| STE-14D471KQ | 300 | 385 | 470(423-517) | 775 | 50 | 6000 | 4500 | 149.8 | 0.6 | 400 |
| STE-14D511KQ | 320 | 415 | 510(459-561) | 845 | 50 | 6000 | 4500 | 149.8 | 0.6 | 350 |
| STE-14D561KQ | 350 | 460 | 560(504-616) | 925 | 50 | 6000 | 4500 | 149.8 | 0.6 | 360 |
| STE-14D621KQ | 385 | 505 | 620(558-682) | 1025 | 50 | 6000 | 4500 | 168 | 0.6 | 330 |
| STE-14D681KQ | 420 | 560 | 680(612-748) | 1120 | 50 | 6000 | 4500 | 168 | 0.6 | 320 |
| STE-14D751KQ | 460 | 615 | 750(675-825) | 1240 | 50 | 6000 | 4500 | 203 | 0.6 | 310 |
| STE-14D781KQ | 485 | 640 | 780(702-858) | 1290 | 50 | 6000 | 4500 | 203 | 0.6 | 260 |
| STE-14D821KQ | 510 | 670 | 820(738-902) | 1355 | 50 | 6000 | 4500 | 203 | 0.6 | 280 |
| STE-14D911KQ | 550 | 745 | 910(819-1001) | 1500 | 50 | 6000 | 4500 | 217 | 0.6 | 250 |
| STE-14D102KQ | 625 | 825 | 1000(900-1100) | 1650 | 50 | 6000 | 4500 | 217 | 0.6 | 230 |
| STE-14D112KQ | 680 | 895 | 1100(990-1210) | 1815 | 50 | 6000 | 4500 | 310 | 0.6 | 180 |

20D-Q Series

| Part Number | Maximum Allowable Voltage | | Varistor Voltage | Maximum Clamping Voltage | | | Peak Current Rating(8/20 μ s) | | Maximum Energy (10/1000 μ s) (J) | Rated Power (W) | Typical Capacitance (Reference) 1KHz (pF) |
|--------------|---------------------------|--------------------------|------------------|--------------------------|-----------|-----------|-----------------------------------|----------------|---|--------------------|--|
| | AC _{rms} (V) | DC _{rms} (V) | | V _{1mA} (V) | VC (V) | IP (A) | 1 pulse (A) | 2 pulse (A) | | | |
| STE-20D820KQ | 50 | 65 | 82(74-90) | 135 | 100 | 10000 | 6500 | 37.8 | 1.0 | 7500 | |
| STE-20D101KQ | 60 | 85 | 100(90-110) | 165 | 100 | 10000 | 6500 | 42 | 1.0 | 6500 | |
| STE-20D121KQ | 75 | 100 | 120(108-132) | 200 | 100 | 10000 | 6500 | 56 | 1.0 | 5500 | |
| STE-20D151KQ | 95 | 125 | 150(135-165) | 250 | 100 | 10000 | 6500 | 70 | 1.0 | 4500 | |
| STE-20D181KQ | 115 | 150 | 180(162-198) | 300 | 100 | 10000 | 6500 | 84 | 1.0 | 2200 | |
| STE-20D201KQ | 130 | 170 | 200(180-220) | 340 | 100 | 10000 | 6500 | 98 | 1.0 | 1700 | |
| STE-20D221KQ | 140 | 180 | 220(198-242) | 360 | 100 | 10000 | 6500 | 105 | 1.0 | 1600 | |
| STE-20D241KQ | 150 | 200 | 240(216-264) | 395 | 100 | 10000 | 6500 | 112 | 1.0 | 1500 | |
| STE-20D271KQ | 175 | 225 | 270(243-297) | 455 | 100 | 10000 | 6500 | 126 | 1.0 | 1300 | |
| STE-20D301KQ | 190 | 250 | 300(270-330) | 500 | 100 | 10000 | 6500 | 133 | 1.0 | 1300 | |
| STE-20D331KQ | 210 | 275 | 330(297-363) | 550 | 100 | 10000 | 6500 | 140 | 1.0 | 1100 | |
| STE-20D361KQ | 230 | 300 | 360(324-396) | 595 | 100 | 10000 | 6500 | 168 | 1.0 | 1100 | |
| STE-20D391KQ | 250 | 320 | 390(351-429) | 650 | 100 | 10000 | 6500 | 182 | 1.0 | 1100 | |
| STE-20D431KQ | 275 | 350 | 430(387-473) | 710 | 100 | 10000 | 6500 | 196 | 1.0 | 1000 | |
| STE-20D471KQ | 300 | 385 | 470(423-517) | 775 | 100 | 10000 | 6500 | 210 | 1.0 | 900 | |
| STE-20D511KQ | 320 | 415 | 510(459-561) | 845 | 100 | 10000 | 6500 | 210 | 1.0 | 800 | |
| STE-20D561KQ | 350 | 460 | 560(504-616) | 925 | 100 | 10000 | 6500 | 210 | 1.0 | 710 | |
| STE-20D621KQ | 385 | 505 | 620(558-682) | 1025 | 100 | 10000 | 6500 | 224 | 1.0 | 700 | |
| STE-20D681KQ | 420 | 560 | 680(612-748) | 1120 | 100 | 10000 | 6500 | 224 | 1.0 | 650 | |
| STE-20D751KQ | 460 | 615 | 750(675-825) | 1240 | 100 | 10000 | 6500 | 266 | 1.0 | 600 | |
| STE-20D781KQ | 485 | 640 | 780(702-858) | 1290 | 100 | 10000 | 6500 | 440 | 1.0 | 510 | |
| STE-20D821KQ | 510 | 670 | 820(738-902) | 1355 | 100 | 10000 | 6500 | 266 | 1.0 | 530 | |
| STE-20D911KQ | 550 | 745 | 910(819-1001) | 1500 | 100 | 10000 | 6500 | 280 | 1.0 | 500 | |
| STE-20D102KQ | 625 | 825 | 1000(900-1100) | 1650 | 100 | 10000 | 6500 | 280 | 1.0 | 450 | |
| STE-20D112KQ | 680 | 895 | 1100(990-1210) | 1815 | 100 | 10000 | 6500 | 620 | 1.0 | 360 | |

Dimensions (mm) and Approval

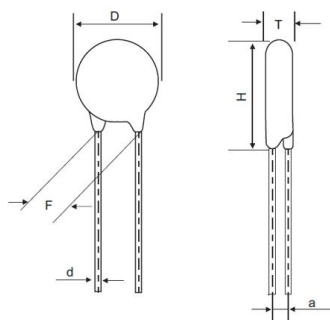

10D-Q Series

| Part No. | Size (mm) | | | | Approval | | | |
|--------------|-----------|--------|-------|--------|----------|-----|----------|--------------|
| | D Max. | T Max. | F±0.8 | d±0.05 | CQC | VDE | UL (USA) | cUL (Canada) |
| STE-10D391KQ | 13.5 | 5.5 | 7.5 | 0.7 | √ | √ | √ | √ |
| STE-10D431KQ | 13.5 | 6.0 | 7.5 | 0.7 | √ | √ | √ | √ |
| STE-10D471KQ | 13.5 | 6.0 | 7.5 | 0.7 | √ | √ | √ | √ |
| STE-10D511KQ | 13.5 | 6.5 | 7.5 | 0.7 | √ | √ | √ | √ |
| STE-10D561KQ | 13.5 | 6.5 | 7.5 | 0.7 | √ | √ | √ | √ |
| STE-10D621KQ | 13.5 | 7.0 | 7.5 | 0.7 | √ | √ | √ | √ |
| STE-10D681KQ | 13.5 | 7.5 | 7.5 | 0.7 | √ | √ | √ | √ |
| STE-10D751KQ | 13.5 | 7.5 | 7.5 | 0.7 | √ | √ | √ | √ |
| STE-10D821KQ | 13.5 | 8.0 | 7.5 | 0.7 | √ | √ | √ | √ |
| STE-10D911KQ | 13.5 | 8.5 | 7.5 | 0.7 | √ | √ | √ | √ |
| STE-10D102KQ | 13.5 | 9.0 | 7.5 | 0.7 | √ | √ | √ | √ |
| STE-10D112KQ | 13.5 | 10.0 | 7.5 | 0.7 | √ | | √ | √ |

14D-Q Series

| Part No. | Size (mm) | | | | Approval | | | |
|--------------|-----------|--------|-------|--------|----------|-----|----------|--------------|
| | D Max. | T Max. | F±0.8 | d±0.05 | CQC | VDE | UL (USA) | cUL (Canada) |
| STE-14D820KQ | 16.5 | 4.0 | 7.5 | 0.7 | √ | √ | √ | √ |
| STE-14D101KQ | 16.5 | 4.0 | 7.5 | 0.7 | √ | √ | √ | √ |
| STE-14D121KQ | 16.5 | 4.0 | 7.5 | 0.7 | √ | √ | √ | √ |
| STE-14D151KQ | 16.5 | 4.5 | 7.5 | 0.7 | √ | √ | √ | √ |
| STE-14D181KQ | 16.5 | 4.5 | 7.5 | 0.7 | √ | √ | √ | √ |
| STE-14D201KQ | 16.5 | 4.5 | 7.5 | 0.7 | √ | √ | √ | √ |
| STE-14D221KQ | 16.5 | 5.0 | 7.5 | 0.7 | √ | √ | √ | √ |
| STE-14D241KQ | 16.5 | 4.5 | 7.5 | 0.7 | √ | √ | √ | √ |
| STE-14D271KQ | 16.5 | 4.5 | 7.5 | 0.7 | √ | √ | √ | √ |
| STE-14D301KQ | 16.5 | 5.0 | 7.5 | 0.7 | √ | √ | √ | √ |
| STE-14D331KQ | 16.5 | 5.0 | 7.5 | 0.7 | √ | √ | √ | √ |
| STE-14D361KQ | 16.5 | 5.0 | 7.5 | 0.7 | √ | √ | √ | √ |
| STE-14D391KQ | 16.5 | 5.0 | 7.5 | 0.7 | √ | √ | √ | √ |
| STE-14D431KQ | 16.5 | 5.5 | 7.5 | 0.7 | √ | √ | √ | √ |
| STE-14D471KQ | 16.5 | 5.5 | 7.5 | 0.7 | √ | √ | √ | √ |
| STE-14D511KQ | 16.5 | 6.0 | 7.5 | 0.7 | √ | √ | √ | √ |
| STE-14D561KQ | 16.5 | 6.0 | 7.5 | 0.7 | √ | √ | √ | √ |
| STE-14D621KQ | 16.5 | 6.5 | 7.5 | 0.7 | √ | √ | √ | √ |
| STE-14D681KQ | 16.5 | 6.5 | 7.5 | 0.7 | √ | √ | √ | √ |
| STE-14D751KQ | 16.5 | 7.0 | 7.5 | 0.7 | √ | √ | √ | √ |
| STE-14D781KQ | 16.5 | 7.0 | 7.5 | 0.7 | | | √ | √ |
| STE-14D821KQ | 16.5 | 7.5 | 7.5 | 0.7 | √ | √ | √ | √ |
| STE-14D911KQ | 16.5 | 7.5 | 7.5 | 0.7 | √ | √ | √ | √ |
| STE-14D102KQ | 16.5 | 8.0 | 7.5 | 0.7 | √ | √ | √ | √ |
| STE-14D112KQ | 16.5 | 8.5 | 7.5 | 0.7 | √ | | √ | √ |

20D-Q Series

| Part No. | Size (mm) | | | | | Approval | | | |
|--------------|-----------|--------|-------|---------------|--------------|----------|-----|----------|--------------|
| | D Max. | T Max. | F±0.8 | d±0.05 | | CQC | VDE | UL (USA) | cUL (Canada) |
| | | | | Straight lead | Crimped lead | | | | |
| STE-20D820KQ | 23.0 | 4.0 | 10.0 | 1.0 | 0.7 | √ | √ | √ | √ |
| STE-20D101KQ | 23.0 | 4.5 | 10.0 | 1.0 | 0.7 | √ | √ | √ | √ |
| STE-20D121KQ | 23.0 | 4.5 | 10.0 | 1.0 | 0.7 | √ | √ | √ | √ |
| STE-20D151KQ | 23.0 | 5.0 | 10.0 | 1.0 | 0.7 | √ | √ | √ | √ |
| STE-20D181KQ | 23.0 | 5.0 | 10.0 | 1.0 | 0.7 | √ | √ | √ | √ |
| STE-20D201KQ | 23.0 | 5.0 | 10.0 | 1.0 | 0.7 | √ | √ | √ | √ |
| STE-20D221KQ | 23.0 | 5.5 | 10.0 | 1.0 | 0.7 | √ | √ | √ | √ |
| STE-20D241KQ | 23.0 | 5.0 | 10.0 | 1.0 | 0.7 | √ | √ | √ | √ |
| STE-20D271KQ | 23.0 | 5.0 | 10.0 | 1.0 | 0.7 | √ | √ | √ | √ |
| STE-20D301KQ | 23.0 | 5.5 | 10.0 | 1.0 | 0.7 | √ | √ | √ | √ |
| STE-20D331KQ | 23.0 | 5.5 | 10.0 | 1.0 | 0.7 | √ | √ | √ | √ |
| STE-20D361KQ | 23.0 | 5.5 | 10.0 | 1.0 | 0.7 | √ | √ | √ | √ |
| STE-20D391KQ | 23.0 | 5.5 | 10.0 | 1.0 | 0.7 | √ | √ | √ | √ |
| STE-20D431KQ | 23.0 | 6.0 | 10.0 | 1.0 | 0.7 | √ | √ | √ | √ |
| STE-20D471KQ | 23.0 | 6.0 | 10.0 | 1.0 | 0.7 | √ | √ | √ | √ |
| STE-20D511KQ | 23.0 | 6.5 | 10.0 | 1.0 | 0.7 | √ | √ | √ | √ |
| STE-20D561KQ | 23.0 | 6.5 | 10.0 | 1.0 | 0.7 | √ | √ | √ | √ |
| STE-20D621KQ | 23.0 | 7.0 | 10.0 | 1.0 | 0.7 | √ | √ | √ | √ |
| STE-20D681KQ | 23.0 | 7.0 | 10.0 | 1.0 | 0.7 | √ | √ | √ | √ |
| STE-20D751KQ | 23.0 | 7.5 | 10.0 | 1.0 | 0.7 | √ | √ | √ | √ |
| STE-20D781KQ | 23.0 | 7.5 | 10.0 | 1.0 | 0.7 | | | √ | √ |
| STE-20D821KQ | 23.0 | 8.0 | 10.0 | 1.0 | 0.7 | √ | √ | √ | √ |
| STE-20D911KQ | 23.0 | 8.5 | 10.0 | 1.0 | 0.7 | √ | √ | √ | √ |
| STE-20D102KQ | 23.0 | 8.5 | 10.0 | 1.0 | 0.7 | √ | √ | √ | √ |
| STE-20D112KQ | 23.0 | 9.0 | 10.0 | 1.0 | 0.7 | √ | | √ | √ |

Lead Configuration

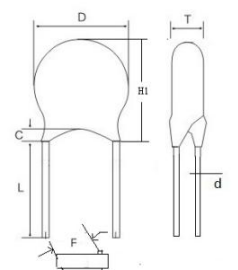
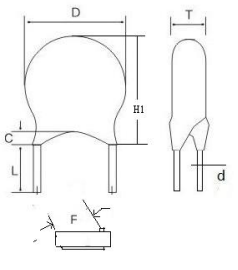
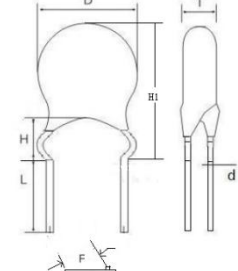
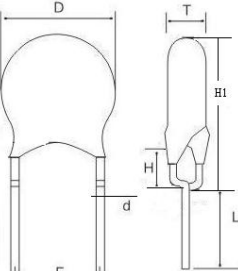
| Lead Style | Drawing | Lead Length L (mm) | Coating Lead Length C (mm) | Height H (mm) |
|------------------|---|--|----------------------------|---------------|
| Long Straight |  | 16.0 min | 3.0 Max | / |
| Short Straight |  | ①[2.5≤L < 6.0]±0.5; ②[6.0≤L≤10]±1.0 | 3.0 Max | / |
| Outside Crimped |  | ①[2.5≤L < 6.0]±0.5; ②[6.0≤L≤10]±1.0 | Not exceed the bend point | 5.5mm Max |
| Vertical Crimped |  | ①[2.5≤L < 6.0]±0.5; ②[6.0≤L≤10]±1.0 | Not exceed the bend point | 4.5mm Max |

Taping And Dimensions (mm)

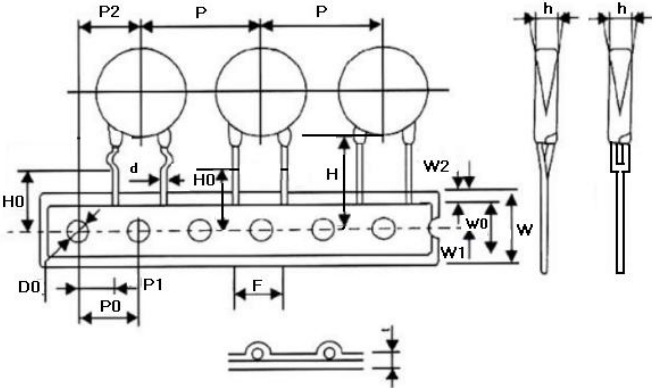
| Figure | Symbol | P=7.5 | | P=10.0 | | |
|--|--------|-----------------------------|----------|-----------------------------|---------------|--------------|
|  | Po | 12.7±0.3 | | 12.7±0.3 | | |
| | P | 25.4±1.0 | | 25.4±1.0 | | |
| | P1 | 8.95±0.7 | | 7.7±0.7 | | |
| | P2 | 12.7±1.3 | | 12.7±1.3 | | |
| | F | 7.5±0.8 | | 10.0±0.8 | | |
| | Δh | 0±2.0 | | 0±2.0 | | |
| | W | 18.0 +1.5/-1.0 | | 18.0 +1.5/-1.0 | | |
| | Wo | 10.5 Max | | 10.5 Max | | |
| | W1 | 9.0+0.75/-0.5 | | 9.0+0.75/-0.5 | | |
| | W2 | 3.0 Max | | 3.0 Max | | |
| | Do | 4.0±0.2 | | 4.0±0.2 | | |
| | H | 20+1.5/-1.0 | | 20+1.5/-1.0 | | |
| | Ho | 16.5&17.0&19.0 +1.5/-1.0 | | 16.5&17.0&19.0 +1.5/-1.0 | | |
| | L | Straight Lead | | | Straight Lead | Crimped Lead |
| | | | 11.0 Max | 9.0 Max | 11.0 Max | 9.0 Max |
| | t1 | 0.5±0.2 | | 0.5±0.2 | | |
| | t2 | 1.7 Max | | 1.7 Max | | |

X-ON Electronics

Largest Supplier of Electrical and Electronic Components

Click to view similar products for [Varistors](#) category:

Click to view products by [Songtian](#) manufacturer:

Other Similar products are found below :

[820443211E](#) [MLV0402E30703T](#) [MLV0603E30403T](#) [B72205S271K111](#) [B72207S350K311](#) [B72207S381K101](#) [B72260B102K1](#)
[B72260B251K1](#) [B72280B0381K001](#) [B72280B0461K001](#) [B72280B271K1](#) [B72650M0151K093](#) [B72660M0271K093](#) [S10K11G5S5](#) [ERZ-](#)
[C07DK221U](#) [TND10V-471KB00AAA0](#) [B72205S301K211](#) [B72207S141K111](#) [B72210S271K111](#) [B72214S350K551](#) [B72220P3351K101](#)
[B72280B0231K001](#) [B72280B112K1](#) [B72280B381K1](#) [B72590D360A60](#) [B72650M0400K072](#) [B72650M0500K072](#) [B72660M0200K072](#)
[B72660M1300K072](#) [B72670M1140K72](#) [MLV0603E30703T](#) [MLV0603E32503T](#) [TVZ18EC271KBS](#) [TVZ20EB911KBS](#) [TVZ25D201KBS](#)
[TVZ25D241KBS](#) [419-2080-101](#) [ERZ-V20R201](#) [MLV0805E31103T](#) [MLV0805E30703T](#) [ERZ-V20R221](#) [B72205S350K211](#)
[B72210P2511K101](#) [B72214S271K501](#) [B72220P3551K101](#) [B72240B681K1](#) [B72650M350K72](#) [TVZ20ECN511KBS](#) [TVZ20EC911KBS](#)
[TVZ20EBN911KBS](#)