

SPECIFICATIONS FOR APPROVAL



Customer Part No.: _____ HELE. Part No: **SSW32768KE3CH-I**

Application For: _____ Products: **OSCILLATOR**

Accepted Model: _____ Type & Freq.: **HSO321S(RTC)/32.768KHz**

Sample Order No: **EOS-D40084-1** Date: **2013/04/12**

Approved By :

加高電子股份有限公司

HARMONY ELECTRONICS CORP.

HARMONY ELECTRONICS (THAILAND) CO., LTD.

HARMONY ELECTRONICS (SHENZHEN) CORP., LTD.

HARMONY ELECTRONICS (SUZHOU) CO.,LTD

TAIPEI OFFICE:

公司:(114)
台北市內湖區堤頂大道 2 段 409
號 2 樓
2F., NO.409, SEC.2, TIDING
BLVD., NEIHU DISTRICT,
TAIPEI CITY 114, TAIWAN
TEL:886-2-26588883
FAX:886-2-26588683

TAIWAN FACTORY:

工廠:(831)
高雄市大寮區大發工業區華東路
39 號
No.39, HWA DONG RD.,
DALLIAO DIST.,DAFA
INDUSTRIAL PARK.,
KAOHSIUNG CITY 831,
TAIWAN
TEL: (07)787-1555-6
FAX: (07)787-1557

THAILAND FACTORY:

66MOO 5,
KAONGU-BEOKPRAI RD.,
T.BEOKPRAI, A. BANPONG,
RAJCHABUREE PROVINCE
70110, THAILAND
TEL: (032)221994-6,
200740-1
FAX: (032)200742

SHENZHEN FACTORY:

深圳市福永鎮塘尾村塘橋路聚源
工業區
QIAO TANG RD., TANGWEI
VILLAGE FU YONG TOWN
SHENZHEN CITY CHINA
TEL: 0755-27309272 /
27309262
FAX: 0755-27309755

SUZHOU FACTORY:

蘇州市相城區黃埭鎮安民路 5 號
NO.5 ANMING ROAD,
HUANGDAI TOWN,
XIANGCHENG DISTRICT,
SUZHOU CITY, JIANGSU
PROVINCE
TEL:86-512-67592373
FAX:86-512-67592363

Title				Country of origin		
HSO321S(RTC) SPECIFICATION				TAIWAN FACTORY		
Date	Confirm	Check	Prepare	Spec. No.	Rev.	Page
2013/04/12	F. S. TSAI	C. H. WENG	U. F. CHEN	SSW32768KE3CH-I	0	1

HARMONY ELECTRONICS CORP.

HSO321S(RTC) SPECIFICATION

INDEX

ITEM	PAGE
1. Type	3
2. Output Frequency	3
3. Absolute Maximum Ratings	3
4. Electric Specifications	3-4
5. Dimensions	5
6. Inside Structure	6
7. Mechanical Performance	6
8. Environment Performance	7
9. Supplement	8-9
10. Taping and Packing	9-11
11. Flow Chart	12
12.Environmental Workload Chemical Substance Components List . .	13

Title				Country of origin		
HSO321S(RTC) SPECIFICATION				TAIWAN FACTORY		
Date	Confirm	Check	Prepare	Spec. No.	Rev.	Page
2013/04/12	F. S. TSAI	C. H. WENG	U. F. CHEN	SSW32768KE3CH-I	0	2

1. Type Name :
HSO321S(RTC)

2. Output Frequency :
32.768000 KHz

3. Absolute Maximum Ratings :

Item	Symbol	Value	Unit
Vdd terminal voltage	Vdd	-0.5 ~ 4.0	V
Input terminal voltage	Vcont	-0.5 ~ Vdd+0.5	V
Output terminal voltage	Vout	-0.5 ~ Vdd+0.5	V
Output terminal current	Iout	10	mA
Storage temp. range	Tstr	-55 ~ 125	deg.C

4. Electric Specifications :

Item	Symbol	Value			Unit	Condition		
		Min	Typ	Max		Etc	Vdd	Temp
Frequency Stability	$\Delta f/F$	-25	-	+25	ppm		3.3+/- 0.3V	-10~70 °C
Operating temp. range	Topr	-10	25	+70	°C			
Supply voltage	Vdd	3.0	3.3	3.6	V			
Current consumption 1 (#1 pin: open or "H")	Idd1	-	-	3	mA	Fig1,2	3.3V	25+/-3 °C
Current consumption 2 (#1 pin: "L" level)	Idd2	-	-	0.01	mA			
Symmetry	Duty	40	50	60	%			
Low level output voltage	Vol	-	-	0.1xVdd	V			
High level output voltage	Voh	0.9xVdd	-	-	V			
Rise & Fall time	Tr & Tf	-	-	10	ns			
Pin #1 options	YES							
Output load	C-MOS CL = 15pF (Idd1, Idd2 test at No Load)							
Low level input current	Iil	-	-	10	uA	Fig3	3.3V	25+/-3 °C
High Level input current	Iih	-	-	10	uA			
Low level input voltage	Vil	-	-	Vddx0.3	V			
High level input voltage	Vih	Vddx0.7	-	-	V			
Output disable time	Tplz	-	-	150	nsce			
Output enable time	Tpzi	-	-	5	msce			
Aging	-	-3	-	3	ppm/year			

F :Output Frequency

Δf =Oscillation Frequency – F

Frequency Stability is inclusive of 25°C

Tolerance, operating temperature range, input voltage change,
Load chang, first of aging , shock and vibration.

Moisture Sensitivity Level : Level 1

Title				Country of origin		
HSO321S(RTC) SPECIFICATION				TAIWAN FACTORY		
Date	Confirm	Check	Prepare	Spec. No.	Rev.	Page
2013/04/12	F. S. TSAI	C. H. WENG	U. F. CHEN	SSW32768KE3CH-I	0	3

HARMONY ELECTRONICS CORP.

Fig. 1) Measurement Circuit :

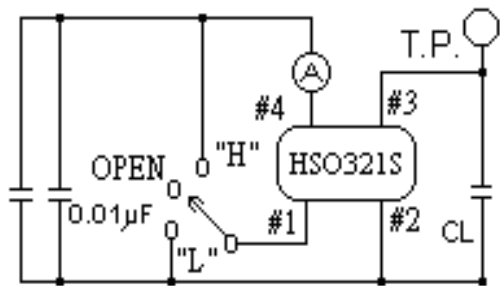

CL = Include jig & probe capacitance
(Refer to 4)

Switch	Out term.
H	Oscillation out
Open	Oscillation out
L	High Z

Fig. 2) Output Wave Form :

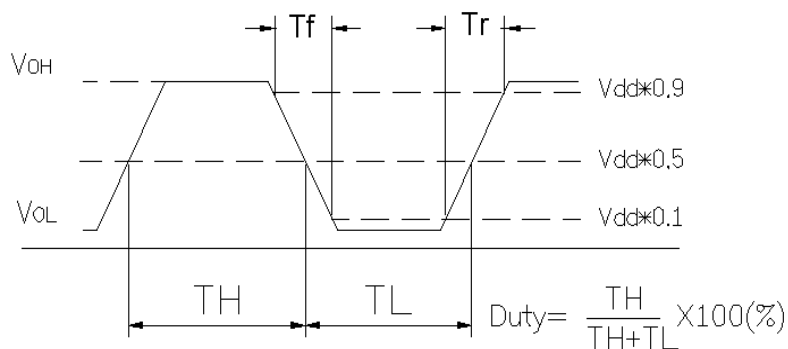
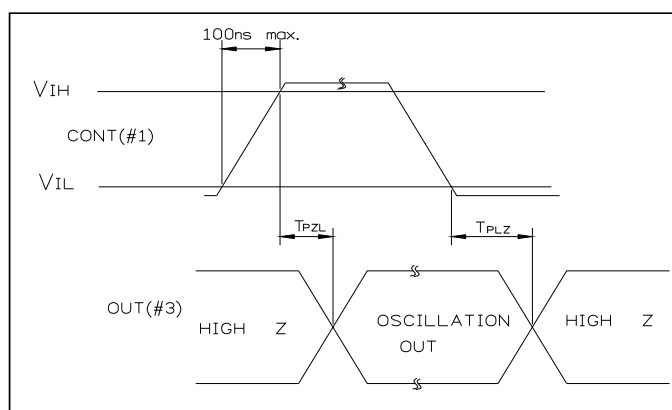
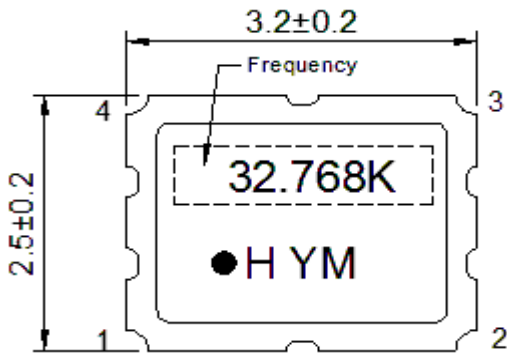

Fig. 3) Input Output Condition :



Title HSO321S(RTC) SPECIFICATION				Country of origin TAIWAN FACTORY		
Date 2013/04/12	Confirm F. S. TSAI	Check C. H. WENG	Prepare U. F. CHEN	Spec. No. SSW32768KE3CH-I	Rev. 0	Page 4

5. Dimensions :



Pin Connections	
1	OE(Output Enable)
2	GND
3	Output
4	Vdd

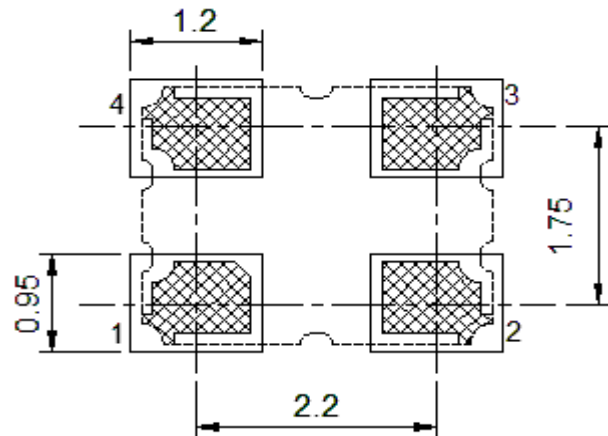
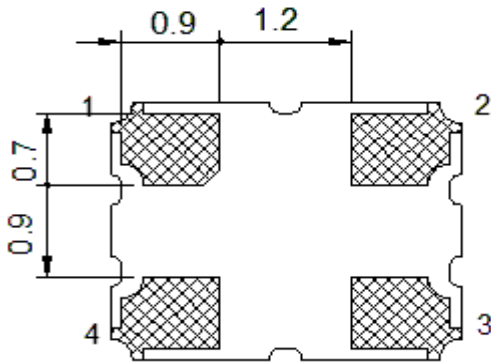
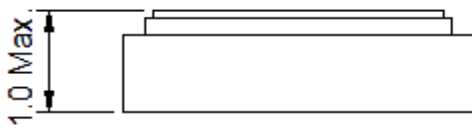

Lot No. :

Year : Last digit of the year

Year	2000	2001	2002	2003	2004	2005	2006	2007	2008	2009
	2010	2011	2012	2013	2014	2015	2016	2017	2018	2019
Code	0	1	2	3	4	5	6	7	8	9

Month : Alphabet assign below

Month	1	2	3	4	5	6	7	8	9	10	11	12
Code	A	B	C	D	E	F	G	H	J	K	L	M

Marking : Laser marking

Title HSO321S(RTC) SPECIFICATION				Country of origin TAIWAN FACTORY		
Date 2013/04/12	Confirm F. S. TSAI	Check C. H. WENG	Prepare U. F. CHEN	Spec. No. SSW32768KE3CH-I	Rev. 0	Page 5

HARMONY ELECTRONICS CORP.

6. Inside Structure :

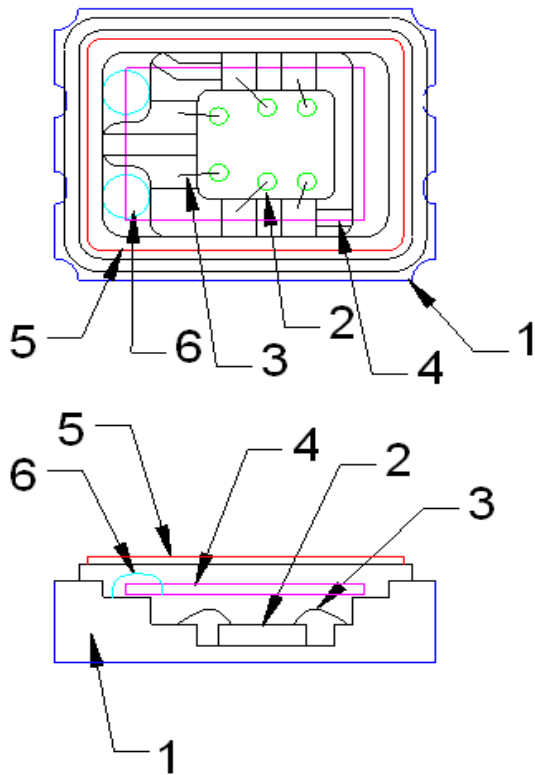

Reference drawing

(1) Base: Alumina Ceramic (Al ₂ O ₃) Metalized Pad: W Ni Plating Au Plating
(2) IC IC(Si. Al. Ti.)
(3) Au Bonding Wire: Au
(4) Crystal Blank Rectangular At-Cut Quartz Crystal Blank
(5) LID: Fe+Ni+Co
(6) Adhesive Silver Conductive Silicon Resin

The use prohibition chemistry substance of Table 1 of DHE-0204-1 (HE-QA-24) is not included in this item.

7. Mechanical Performance :

Item		Test Methods	Specifications Code
1	Natural Drop	Drop 3 times from the height of 50cm onto min. 30mm thickness hard wooden board.	A
2	Vibration	Frequency 10-55Hz, Sine Wave full amplitude of 0.8mm to X, Y and Z 3 axes, Duration of 2 hours to each axis.	A
3	Sealing Tightness	(1) Leak Rate 1.0x10 ⁻⁸ Pa·m ³ /sec. Max. Measured by Helium leak detector. – Fine Leakage. (2) Dipping in the FC-40 at +125 +/-5deg.C for 5 minutes, no gas bubble observed from the inside of the can.	---
4	Solderability	After applying ROSIN Flux, dipping in solder bath at 245deg.C +/-5deg.C for 3 +/-0.5 sec.	B

Title HSO321S(RTC) SPECIFICATION				Country of origin TAIWAN FACTORY		
Date 2013/04/12	Confirm F. S. TSAI	Check C. H. WENG	Prepare U. F. CHEN	Spec. No. SSW32768KE3CH-I	Rev. 0	Page 6

8. Environment Performance :

Item		Test Methods	Specifications Code
1	Humidity	Temperature 60°C +/-2°C, RH 90~95%, Duration of 240 hours. Back to room temperature first, then in 1~2 hours, the component shall be checked.	A
2	Storage in Low Temperature	-40deg.C +/-2deg.C, Duration of 240 hours. Back to the room temperature first, then in 1~2 hours, the component shall be checked.	A
3	Storage in High Temperature	+85deg.C +/-2deg.C, Duration of 240 hours. Back to the room temperature first, then in 1~2 hours, the component shall be checked.	A
4	Temperature cycles	-30deg.C +/-2deg.C (30min) ↔ +80deg.C +/-2deg.C (30min) 25 cycles. Temp. increasing or reducing time need to be within 3 minutes. Back to the room temperature first, then in 1~2 hours, the component shall be checked.	A
5	High Temperature Operation	+85deg.C +/-2deg.C, +3.3V Vdd Duration of 240 hours. Back to the room temperature first, then in 1~2 hours, the component shall be checked.	A

Specifications code	Specifications
A	Frequency variation shall be within +/-5ppm and equivalent resistance shall be within the specification after the test
B	More than 90% of lead shall be covered by new solder.

Title				Country of origin		
HSO321S(RTC) SPECIFICATION				TAIWAN FACTORY		
Date	Confirm	Check	Prepare	Spec. No.	Rev.	Page
2013/04/12	F. S. TSAI	C. H. WENG	U. F. CHEN	SSW32768KE3CH-I	0	7

9. Supplement :

9.1. Please stay with our proposed reflow condition and do then soldering 2 times max.

Available for Lead Free Soldering

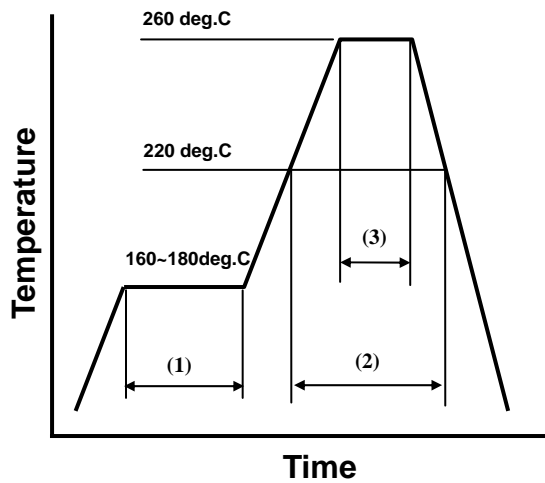

(1)	Preheat	160~180 deg.C	120sec.
(2)	Primary heat	220 deg.C	60sec.
(3)	Peak	260 deg.C	10sec. Max.

9.2.Land Pattern Layout : (Example)

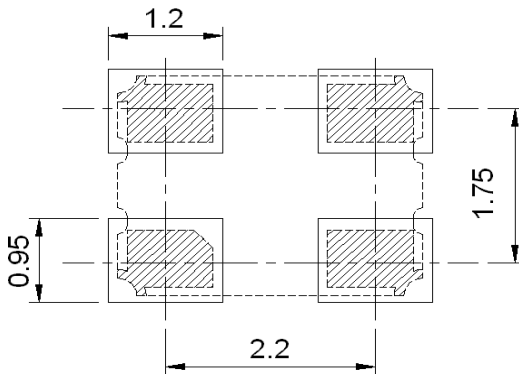

9.3.Solder Iron : (Example)

Bit temp.:350deg.C Max. , Time:3sec Max. , Each terminal solder a 1 time Max.

9.4.Mounting :

This component is designed for automatic insertion.

However, you are requested to do the trial with your insertion machine in order to be sure of proper operation and no damage of component.

Please pay attention to board warp which may damage the component and cause Soldering Process.

9.5.Cleaning :

Title HSO321S(RTC) SPECIFICATION				Country of origin TAIWAN FACTORY		
Date 2013/04/12	Confirm F. S. TSAI	Check C. H. WENG	Prepare U. F. CHEN	Spec. No. SSW32768KE3CH-I	Rev. 0	Page 8

Cleaning liquid which corrodes Nickel shall not be used.
 It may cause the problem on the surface, color, marking etc.
 Ultra-sonic cleaning is possible, however, you are requested to check on your board.
 Because we only checked as single unit.

9.6.Handling :

HSO321S series is designed to withstand Drop and Vibration, however, the crystal blank might be broken. So, if excess force is given, please check the characteristics before use.

HSO321S series has C-MOS circuit inside. Please pay attention to static-electricity as same handling as other C-MOS. devices.

9.7.By-pass Capacitor :

It has no by-pass capacitor integrated. We recommend you to use capacitor (like ceramic chip capacitor) $0.01 \mu F$ in-between Vdd and GND.

9.8.Storage :

Please keep away from high temperature and high humidity, which may cause put solderbility. No direct Sunlight, No dew as well.

10. Taping and Packing :

10.1.Emboss Tape Specifications :

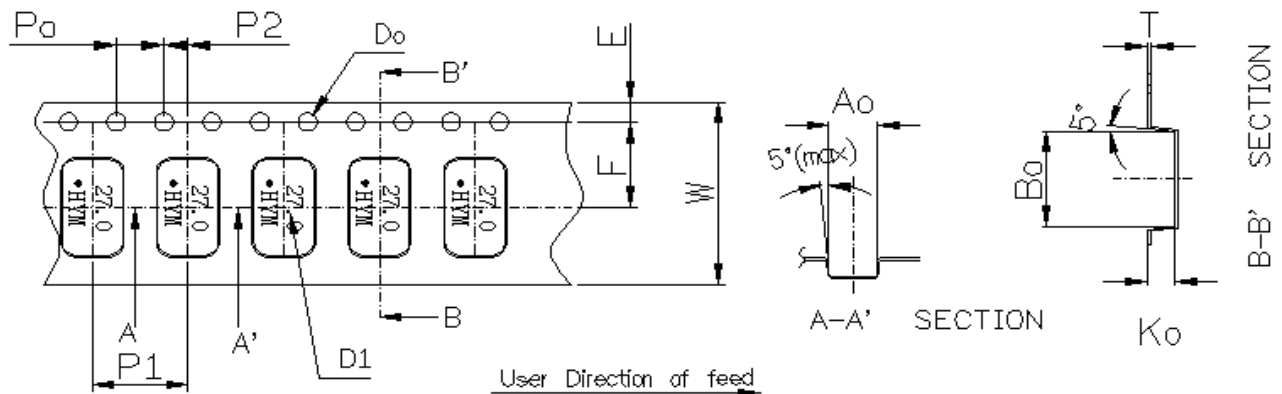

Symbol	Ao	Bo	Ko	Po	P1	P2
Spec	2.70±0.1	3.4±0.1	1.40±0.1	4.0±0.1	4.0±0.1	2.0±0.05
Symbol	E	F	Do	D1	W	T
Spec	1.75±0.1	3.5±0.05	∅1.55±0.05	∅1.0(min)	8.0±0.2	0.25±0.05

Title HSO321S(RTC) SPECIFICATION				Country of origin TAIWAN FACTORY		
Date 2013/04/12	Confirm F. S. TSAI	Check C. H. WENG	Prepare U. F. CHEN	Spec. No. SSW32768KE3CH-I	Rev. 0	Page 9

10.2.Reel Specifications :

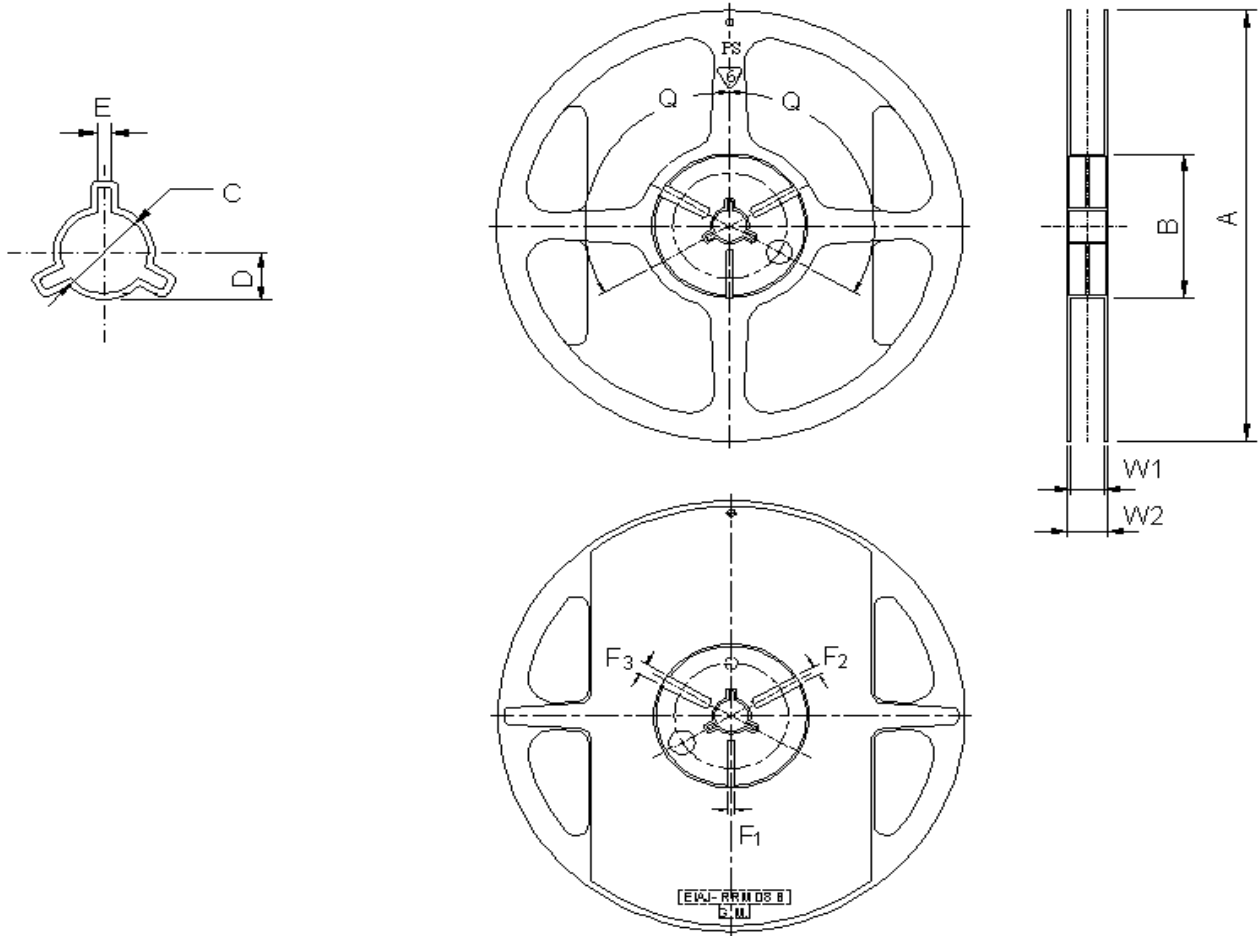

(Table-2)

(UNIT: mm)

ITEM		MARK	DIMENSIONS · ANGLE	
FLANGE	Diameter	A	$\phi 180+0/-3$	
	Inner Width	W1	$9.3+/-0.3$	
	Outer Width	W2	$11.3+/-1.0$	
HUB	Out Line diameter		B	$\phi 60.5+/-0.5$
	Center Core slit	Width	F1	$3.0+0.5/-0$
			F2	$4.0+0.5/-0$
			F3	$5.0+0.5/-0$
	Position		q	120deg
	Spindle diameter		C	$\phi 13.2+/-0.5$
Key Ditch	Width	E	$3.0+/-0.2$	

10.3.Storage :

Title HSO321S(RTC) SPECIFICATION				Country of origin TAIWAN FACTORY		
Date 2013/04/12	Confirm F. S. TSAI	Check C. H. WENG	Prepare U. F. CHEN	Spec. No. SSW32768KE3CH-I	Rev. 0	Page 10

Temperature+40deg.C Max.
Humidity 80% Max.

10.4.Quantity on Reel :
3,000 PCS/REEL

10.5.Label :
Label is following information :

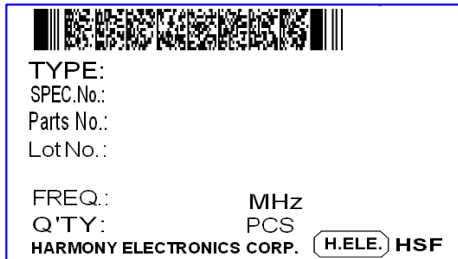

10.6.Shipping Carton :

The size carton box is shown as below. One carton contains 10 reels. In case of less than 10 reels, suitable size of carton will be used. The cushion is filled in the carton box, which material shall be anti-static.

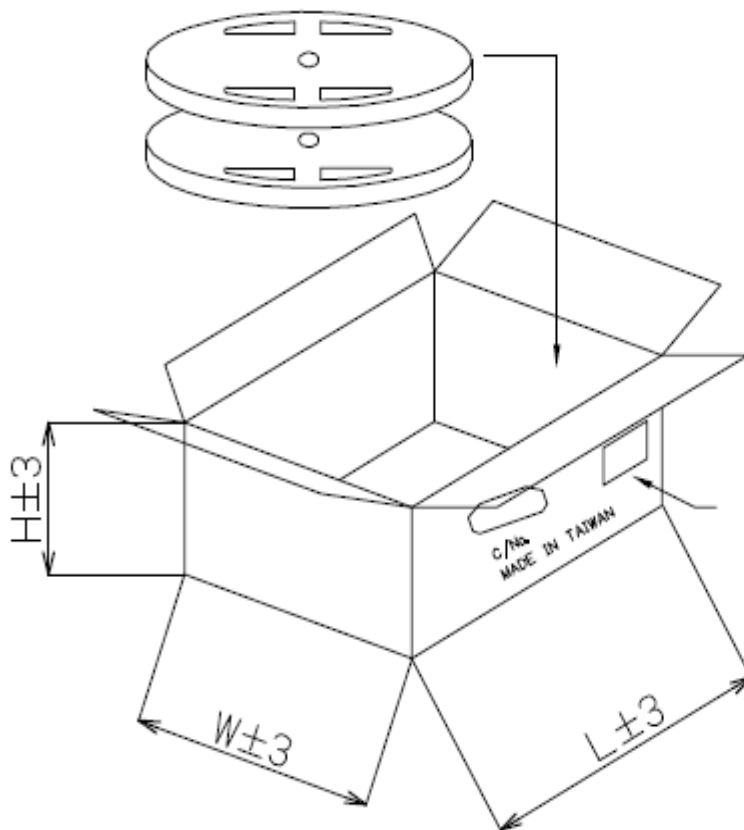

外觀尺寸	20個以下	10個以下
L±3	360	195
W±3	195	195
H±3	120	150

Label

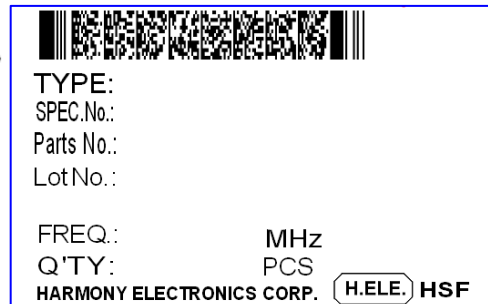

註：1. 外箱側面須印如下圖面



2. 外箱:五層瓦楞紙(紙厚:7±1mm)

3. 尺寸線為外徑尺寸線

11. Flow Chart :

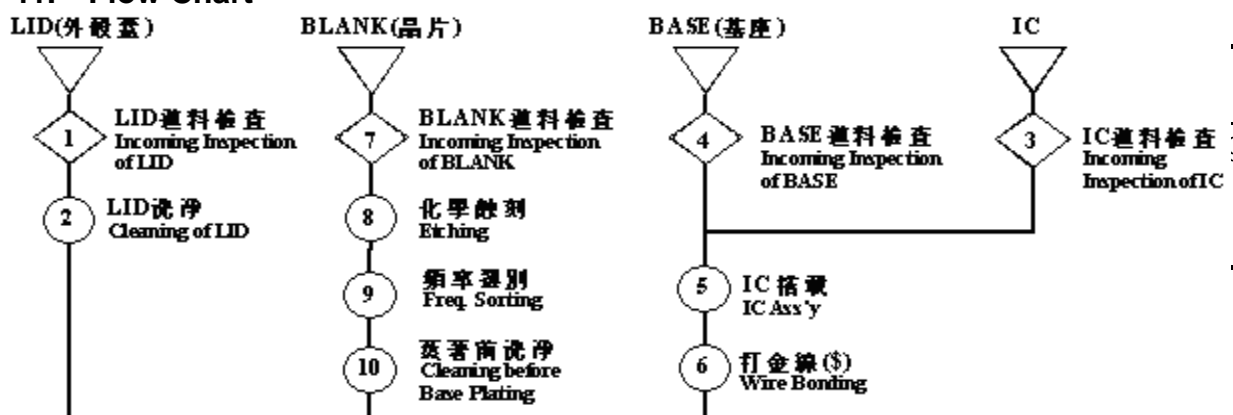

Title
Date
2013

je
11

Title				Country of origin		
HS0321S(RTC) SPECIFICATION				TAIWAN FACTORY		
Date	Confirm	Check	Prepare	Spec. No.	Rev.	Page
2013/04/12	F. S. TSAI	C. H. WENG	U. F. CHEN	SSW32768KE3CH-I	0	12

HARMONY ELECTRONICS CORP.

12. Environmental Workload Chemical Substance Components List

Environmental Workload Chemical Substance Components List		
Chemical Substance Components	TYPE	D(H)SO321S
	PERCENTAGE	25.2(mg) ppm
WOLFRAM AND ITS COMPOUND(W)	0.21168	53.3434
COBALT AND ITS COMPOUND(Co)	0.96900	244.1880
CHROMIUM AND ITS COMPOUND(Cr)	0.07308	18.4162
SILVER(Ag)	0.15876	40.0075
COPPER(Cu)	0.07812	19.6862
NICKEL AND ITS COMPOUND(Ni)	2.26044	569.6309
MANGANESE AND ITS COMPOUND(Mn)	0.02016	5.0803
MOLYBDENUM AND ITS COMPOUND(Mo)	0.12348	31.1170
SILICON AND ITS COMPOUND(Si)	0.28476	71.7595
ALUMINIUM AND ITS COMPOUND(Al)	7.96320	2006.7264
GOLD(Au)	0.15372	38.7374
IRON(Fe)	3.37176	849.6835

Title				Country of origin		
HSO321S(RTC) SPECIFICATION				TAIWAN FACTORY		
Date	Confirm	Check	Prepare	Spec. No.	Rev.	Page
2013/04/12	F. S. TSAI	C. H. WENG	U. F. CHEN	SSW32768KE3CH-I	0	13

HARMONY ELECTRONICS CORP.

X-ON Electronics

Largest Supplier of Electrical and Electronic Components

Click to view similar products for [Standard Clock Oscillators](#) category:

Click to view products by [Harmony](#) manufacturer:

Other Similar products are found below :

[EP1400SJTSC-125.000M](#) [601137](#) [601252](#) [CSX750FBC-24.000M-UT](#) [CSX750FBC-33.333M-UT](#) [CSX750FCC-3.6864M-UT](#) [F335-12](#) [F335-25](#) [F535L-50](#) [DSC506-03FM2](#) [ASA-20.000MHZ-L-T](#) [ASA-25.000MHZ-L-T](#) [ASA-27.000MHZ-L-T](#) [ASV-20.000MHZ-LR-T](#) [ECS-2018-160-BN-TR](#) [EL13C7-H2F-125.00M](#) [MXO45HS-2C-66.6666MHZ](#) [NBXDBB017LN1TAG](#) [NBXHBA019LN1TAG](#) [SiT1602BI-22-33E-50.000000E](#) [SIT8003AC-11-33S-2.04800X](#) [SiT8256AC-23-33E-156.250000X](#) [SIT8918AA-11-33S-50.000000G](#) [SM4420TEV-40.0M-T1K](#) [SMA4306-TL-H](#) [F335-24](#) [F335-40](#) [F335-50](#) [F535L-10](#) [F535L-12](#) [F535L-16](#) [F535L-24](#) [F535L-27](#) [F535L-48](#) [PE7744DW-100.0M](#) [CSX750FBC-20.000M-UT](#) [CSX-750FBC33333000T](#) [CSX750FBC-4.000M-UT](#) [CSX750FBC-7.3728M-UT](#) [CSX750FBC-8.000M-UT](#) [CSX-750FCC14745600T](#) [CSX750FCC-16.000M-UT](#) [CSX-750FCC40000000T](#) [CSX750FCC-4.000M-UT](#) [ASA-22.000MHZ-L-T](#) [ASA2-26.000MHZ-L-T](#) [ASA-40.000MHZ-L-T](#) [ASA-48.000MHZ-L-T](#) [ASA-60.000MHZ-L-T](#) [ASF1-3.686MHZ-N-K-S](#)