

H.ELE.

Specifications for Approval



PRODUCT TYPE	Quartz Crystal HSX221SA
NOMINAL FREQUENCY	26.000000MHz
H.ELE. SAMPLE O/N	EOS-HC0286-2
H.ELE. P/N	X2B026000L91H-S
RELEASE DATE	2017/12/19
VERSION	00
MSL	Level 01
GREEN PRODUCT	<input checked="" type="checkbox"/> Pb free <input checked="" type="checkbox"/> RoHS Compliant <input checked="" type="checkbox"/> HF-Halogen free <input checked="" type="checkbox"/> REACH Compliant
CUSTOMER P/N	
APPLICATION & MODEL	
APPROVED BY CUSTOMER	

(DATE)

Harmony Electronics Corp.			
<u>F. S. TSAI</u> (APPROVE)	<u>Y. W. LEE</u> (CHECK)	<u>U. F. CHEN</u> (PREPARE)	Country of Origin: Taiwan Factory Thailand Factory China Factory

HARMONY ELECTRONICS CORPRATION

KAOSIUNG

TAIPEI

THAILAND

SHENZHEN

TEL: 886-2-26588883

Email: contactus@hele.com.tw



Contents

ITEM	PAGE
1. QUARTZ CRYSTAL UNIT SPECIFICATION	3
2. DIMENSIONS	4
3. MARKING	4
4. INSIDE STRUCTURE	5
5. HANDLING SUGGESTIONS	5-6
6. EMBOSS CARRIER TAPE&REEL	6-7
7. PACKAGE	7-8
8. MECHANICAL PERFORMANCE	8-9
9. ENVIRONMENTAL PERFORMANCE	9
10. APPENDIX	

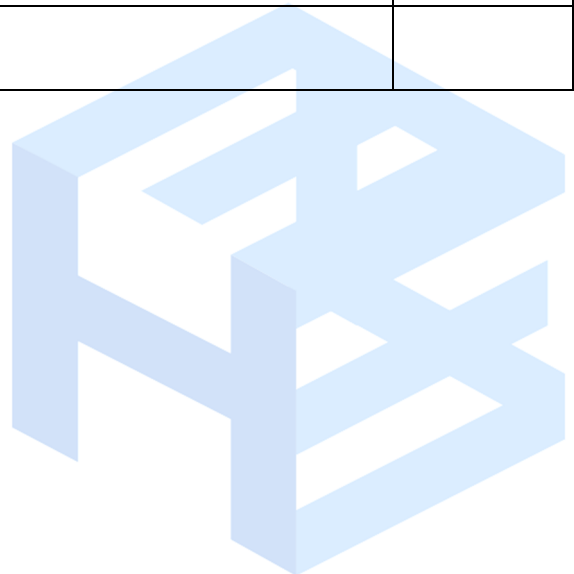

HARMONY ELECTRONICS CORPRATION

KAOSIUNG

TAIPEI

THAILAND

SHENZHEN

TEL: 886-2-26588883

Email: contactus@hele.com.tw



1. QUARZ CRYSTAL UNIT SPECIFICATION

Items	Electrical Spec.			Unit	Notes
	Min	Type	Max		
1. Frequency (FL)	26.000000			MHz	
2. Mode of oscillation	Fundamental				
3. Frequency tolerance	-8		+8	ppm	at 25°C±3°C
4. Equivalent resistance (RR)			80	Ω	SERIES
5. Storage temperature range	-40		+85	°C	
6. Operable temperature range	-20		+75	°C	
7. Temperature stability	-12		+12	ppm	-20°C ~ +75°C
8. Loading capacitance (CL)		9.0		pF	
9. Drive level (DL)		10	100	μW	
10. Shunt Capacitance (C0)			2.0	pF	
11. Insulation resistance	500			MΩ	at DC 100V
12. Aging	-3		+3	ppm/Year	
13. Circuit	Measured in HP/E5100A,S&A 250B				

Note:



HARMONY ELECTRONICS CORPRATION

KAOSIUNG

TAIPEI

THAILAND

SHENZHEN

TEL: 886-2-26588883

Email: contactus@hele.com.tw



2. DIMENSION

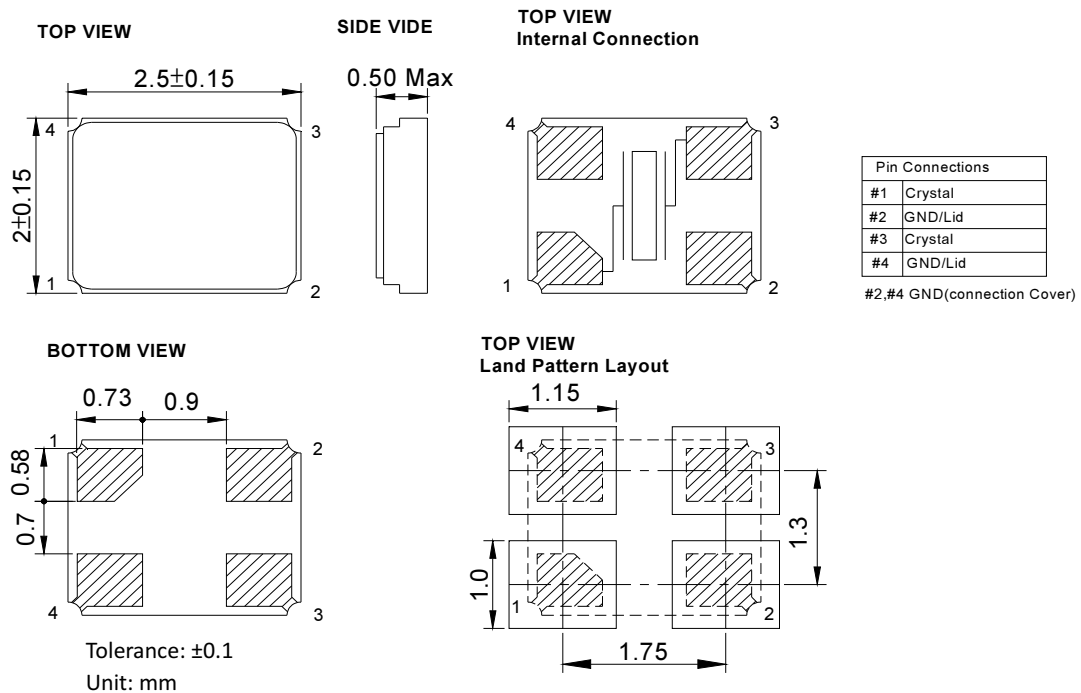

* Note: The Index mark was defined by the BASE suppliers.

3. MARKING

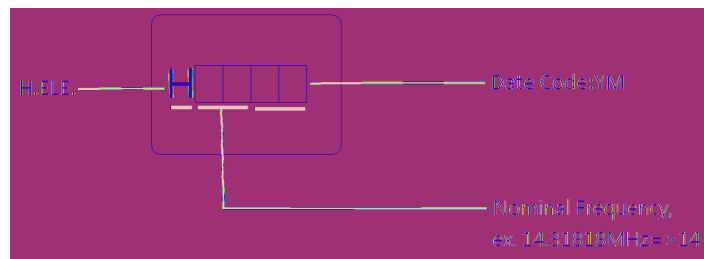

Note:

1. Laser marking.
2. Date Code:

Y=Year	2010	2011	2012	2013	2014	2015	2016	2017	2018	2019
	2020	2021	2022	2023	2024	2025	2026	2027	2028	2029
Code	0	1	2	3	4	5	6	7	8	9

M=Month	Jan.	Feb.	Mar.	Apr.	May.	Jun.	Jul.	Aug.	Sep.	Oct.	Nov.	Dec.
Code	A	B	C	D	E	F	G	H	J	K	L	M

HARMONY ELECTRONICS CORPRATION

KAOHSIUNG

TAIPEI

THAILAND

SHENZHEN

TEL: 886-2-26588883

Email: contactus@hele.com.tw



4. INSIDE STRUCTURE

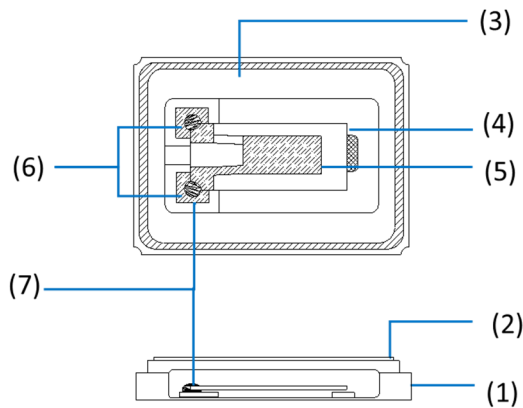

Reference drawing

No.	Component	Material	Note
(1)	Base	Ceramic	Al ₂ O ₃
(2)	Lid	Metal	Fe- Ni -Co Ni Plating
(3)	Kovar	Metal	Fe- Ni -Co
(4)	Crystal Blank	Quartz	SiO ₂ Rectangular At-Cut
(5)	Electrode	Metal	-
(6)	PAD	Metal	W Ni Plating Au Plating
(7)	Connective Adhesive	Silver Powder	Ag

※The use prohibition chemistry substance of Table 1 of DHE-0204-1 (HE-QA-24) is not included in this item.

5. HANDLING SUGGESTION

■ Reflow Conditions

Please stay with our proposed reflow conditions and do soldering within 2 times.

(1)	Preheat	160~180deg.C	120 sec.
(2)	Primary heat	>=220 deg.C	60~120 sec.
(3)	Peak	260 deg.C	10 sec. Max.

■ Manual Solder iron (Example)

Bit temp.: 350°C max., Time: 3sec max. ,

Each terminal solder only should be soldered once.

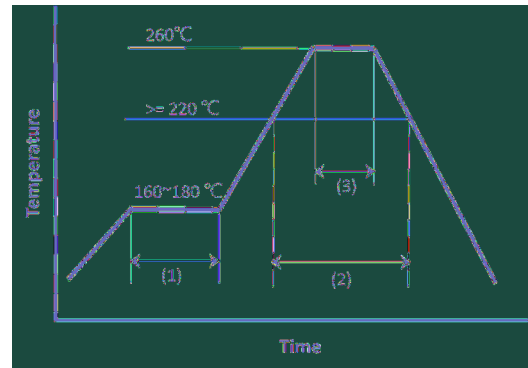

■ Mounting Conditions

Our products are suitable for most automated SMT processes. However, we strongly advise all our customers to conduct SMT sampling prior to mass production in order to make sure production processes will not affect the properties and specifications of our product.

Seal welding and mounting procedures involving the use of ultra-sonic processes are not recommended and will affect and/or damage the internal properties of our product.

Excessive shock during the mounting process will also affect the product and we strongly recommend setting SMT conditions to minimize such conditions.

If a possibility of the PCB being warped exists we strongly advise to ensure the degree of warping will not affect the product.

Please also ensure the operating characteristics and or soldering conditions are all within the specifications of use for our product.

Ultimately the worst case scenario of all the above will lead to cases of non-oscillation but other negative effects are also likely should our products be used in an inappropriate way.

Please note such cases of misuse and its related quality issues are not included in our product warranty.

HARMONY ELECTRONICS CORPRATION

KAOHSIUNG

TAIPEI

THAILAND

SHENZHEN

TEL: 886-2-26588883

Email: contactus@hele.com.tw



■ Cleansing Conditions

General cleaning solutions may be used to clean our products but we always recommend testing to be performed prior to mass production processes. Ultrasonic cleaning procedures are not recommended and we strongly advise other forms of cleansing to be evaluated first. Unsuitable cleansing may lead to a number of negative effects such as damage to the product surface, discoloration of the product, corrosion of the package, package contamination, illegible marking, etc. Please note cases of unadvised treatment and its related quality issues are not included in our product warranty.

■ Storage Conditions

Please ensure our products are preserved appropriately in their original packaging. Irregular environmental instances of moisture will affect our product's stability and may cause problems such as frequency instability, soldering ability and conditions, package defects, and other problems. It is essential to keep our products in a clean dust-free environment out of direct sunlight.

Our products' storage conditions should at least meet the following condition:
Environmental Temperature: + 40 degrees Celsius Maximum
Relative Humidity: 80% Maximum

Please note storage instances which do not conform to our guidelines and the related quality issues produced as an outcome are not included in our product warranty.

6. EMBOSS CARRIER TAPE AND REEL

■ Carrier Tape

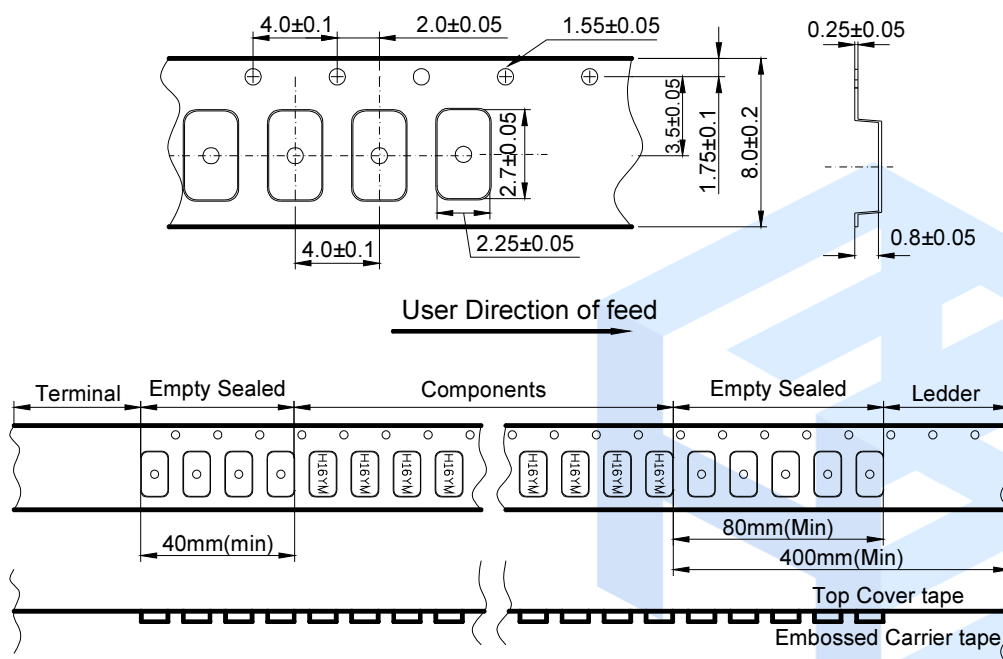

HARMONY ELECTRONICS CORPORATION

KAOHSIUNG

TAIPEI

THAILAND

SHENZHEN

TEL: 886-2-26588883

Email: contactus@hele.com.tw



■ Reel

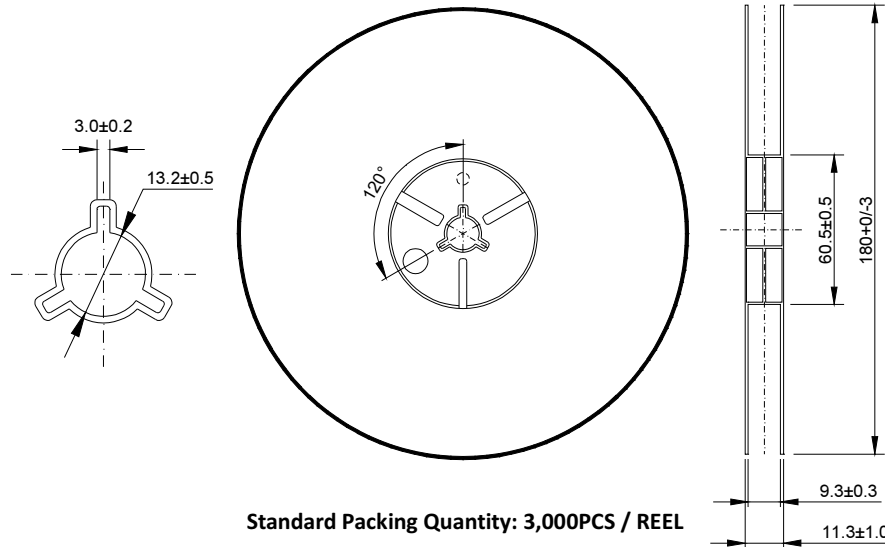

Standard Packing Quantity: 3,000PCS / REEL

■ Material of The Tape

Tape	Material
Carrier tape	PS Conductive
Top tape	PET

■ Joint of tape

The carrier-tape and top cover-tape should not be jointed.

■ Release strength of cover tape

The force should be controlled between 0.1N to 0.7N under following condition.

Pulling direction: 165° to 180°

Speed: 300mm/min.

Otherwise unless specified.

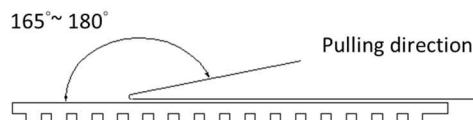

Other standards shall be based on JIS C 0806-1990.

7. PACKAGE

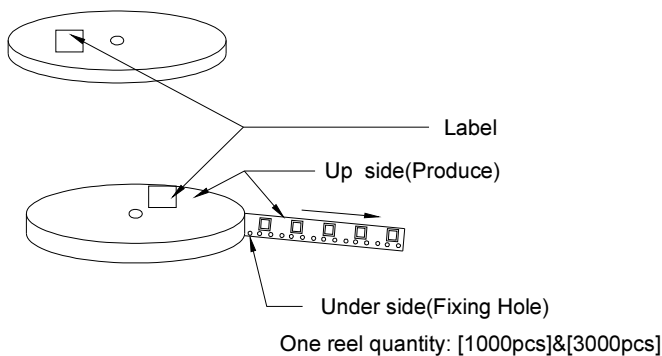

Label Contents

TYPE:
SPEC. No.:
Parts No.:
Lot No.:

FREQ.: MHz
Q'TY: PCS

HARMONY ELECTRONICS CORP.

Q.C PASS H10

HSF

The label will be stickled on all reels.

HARMONY ELECTRONICS CORPRATION

KAOHSIUNG

TAIPEI

THAILAND

SHENZHEN

TEL: 886-2-26588883

Email: contactus@hele.com.tw

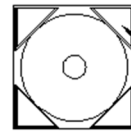

use 4 trigon pilla

Green Product
ROHS Compliant

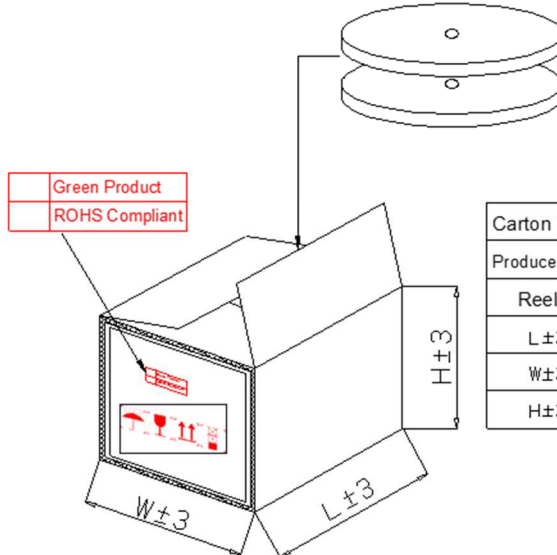

Carton Type	A	B	C	D
Produce Type	840/751	630/531/421	321/221/211/111	OTHER
Reel	15	15	15	1~7
L±3	200	200	200	195
W±3	200	200	200	195
H±3	230/260	230	230	150

- ① Top and bottom with 2.3cm thickness foam-rubber cushion for protection.
- ② Carton's Q'TY: 1~15 pcs.
- ③ Carton Type=A,B,C use 4 trigon pillar to fasten the Reel.
- ④ Need to add 3 pages dry agent in each outer box.

8. MECHANICAL PERFORMANCE

Item		Test Methods	Specifications Code
1	Shock	Dropping from 120 cm height 3 times on 30 mm Concrete floor. Refer to: JIS C 60068-2-32	A
2	Vibration	Frequency 10-55Hz, Sine Wave full amplitude of 0.8mm to X, Y and Z 3 axes, 2 cycles and duration of 2 hours to each direction. Refer to: JIS C 60068-2-6	A
3	Leakage Test	Leak Rate 1.0×10^{-9} Pa·m ³ /sec. Max. Measured by Helium leak detector.	---
4	Solder ability	After applying ROSIN Flux, dipping in solder bath at 245deg.C ± 5 deg.C for 3 ± 0.5 sec. Refer to: JIS C 60068-2-20	B
5	Bending Strength	Mount a sample on board. Apply Pressure to the center of board until it is bent to 3 mm and hold for 5 ± 1 sec. Pressure speed: 0.5 mm/sec. Refer to: EIAJ ET-7403	A

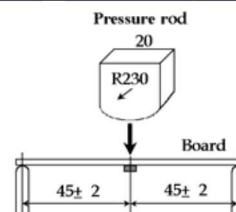

HARMONY ELECTRONICS CORPRATION

KAOHSIUNG

TAIPEI



THAILAND

SHENZHEN

TEL: 886-2-26588883

Email: contactus@hele.com.tw

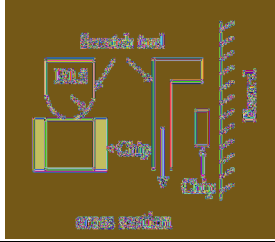

6	Adhesion	Mount a sample on the circuit board. Apply pressure vertically to the side of specimen attached to the circuit board with the pressure jig. Pressure: 5N for 10±1 sec. Refer to: EIAJ ET-7403		C
7	Body strength	Apply pressure to the center of body with the R0.5 pressure jig. pressure :10N for 10±1sec Refer to: EIAJ ET-7403		C

9. ENVIRONMENT PERFORMANCE

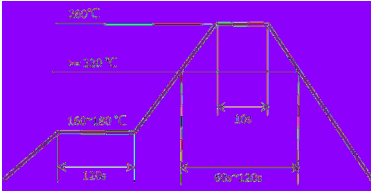
Item	Test Methods	Specifications Code
1	Resistance of Soldering Heat 	A
2	Humidity Temperature 60°C±2°C, RH 90~95%, duration of 240 hours. Back to room temperature first, then check the component after 1~2 hours. Refer to: JIS C 60068-2-3	A
3	Storage in Low Temperature -40deg.C ±2deg.C, duration of 240 hours. Back to the room temperature first, then check the component after 1~2 hours. Refer to: JIS C 60068-2-1	A
4	Storage in High Temperature +85deg.C ±2deg.C, duration of 240 hours. Back to the room temperature first, then check the component after 1~2 hours. Refer to: JIS C 60068-2-2	A
5	Temperature cycles -40deg.C ±2deg.C (30min) ↔ +85deg.C ±2deg.C (30min) 25 cycles. And Temperature Increasing/reducing time < 3mins. Back to the room temperature first, then check the component after 1~2 hours. Refer to: JIS C 0025	A

Specifications code	Specifications
A	FREQ. DRIFT: ±5 ppm Max, RESISTANCE DRIFT: ±15% or 2Ω
B	More than 90% of lead shall be covered by new solder.
C	FREQ. DRIFT: ±15 ppm Max, RESISTANCE DRIFT: ±25% or 10Ω

HARMONY ELECTRONICS CORPRATION

KAOHSIUNG

TAIPEI

THAILAND

SHENZHEN

TEL: 886-2-26588883

Email: contactus@hele.com.tw

FACTORY LOCATION

HEAD OFFICE/TAIWAN FACTORY

No.39, Huadong Rd., Daliao Dist., Dafa Industrial Park,
Kaohsiung City 831, Taiwan (ROC).

CHINA FACTORY

Ju Yuan Industrial Park, Qiao Tang Road, Tang Wei
Community, Fuyong, Baoan District, Shen Zhen City,
China (Post Code:518103)

THAILAND FACTORY

66moo 5, Kaongu-beokprai Rd., t.beokprai, A. Banpong,
Ratchaburi Province 70110, Thailand.

SERVICE CENTER

TAIPEI OFFICE

2F., NO.409, SEC.2, TIDING BLVD., NEIHU DISTRICT,
TAIPEI CITY 114, TAIWAN
TEL: 886-2-26588883
FAX: 886-2-26588683

CONTACT INFORMATION

E-MAIL: contactus@hele.com.tw



加高電子股份有限公司
HARMONY ELECTRONICS CORP.



X-ON Electronics

Largest Supplier of Electrical and Electronic Components

Click to view similar products for [Crystals](#) category:

Click to view products by [Harmony](#) manufacturer:

Other Similar products are found below :

[CS325S24000000ABJT](#) [718-13.2-1](#) [MC405 32.0000K-R3:PURE SN](#) [FC-135R 32.7680KF-A3](#) [7A-40.000MAAE-T](#) [7B-27.000MBBK-T](#)
[FL2000085](#) [9B-15.360MBBK-B](#) [9C-7.680MBBK-T](#) [ASH7K-32.768KHZ](#) [AT-41.600MAGQ-T](#) [BTD1062E05A-513](#) [LFX TAL066198Cutt](#)
[9C-14.31818MBBK-T](#) [FA-238 50.0000MB30X-K3](#) [FC-12M 32.7680KA-AC3](#) [SSPT7F-9PF20-R](#) [FX325BS-38.88EEM1201](#)
[LFX TAL065253Cutt](#) [LFX TAL066431Cutt](#) [XT9S20ANA14M7456](#) [XT9SNLANA16M](#) [646G-24-2](#) [7A-24.576MBBK-T](#) [7B-30.000MBBK-T](#)
[WX26-32.768K-6PF](#) [9B-14.31818MBBK-B](#) [CD1AM](#) [7B-25.000MAAE-T](#) [7A-14.31818MBBK-T](#) [6504-202-1501](#) [6526-202-1501](#) [FA-118T](#)
[27.1200MB50P-K0](#) [FC-135R 32.7680KA-A3](#) [ABM12-104-37.400MHZT](#) [ABLS-10.000MHZ-D3W-T](#) [BTJ112E01E-513](#) [BTJ722K01C-7067](#)
[BTL-20-513](#) [TSX-3225 24.0000MF15X-AC](#) [TSX-3225 16.0000MF18X-AC](#) [BTJ120E02C](#) [BTL-12-513](#) [7A-10.000MBBK-T](#) [7A-](#)
[11.0592MBBK-T](#) [ABM12-103-24.000MHZT](#) [CS325S25000000ABJT](#) [ABM3B-25.000MHZ-B2-X-T](#) [FC-135 32.7680KA-A5](#) [FX0800015](#)