

## Metal Oxide Varistors-Q Series (6KV/3KA) Data Sheet



### Feature

- Wide operating voltage range from 82V to 1100V
- Operating Temperature: -40°C ~ +125°C
- Storage Temperature: 15°C ~ 35°C

### Applications

- The over-voltage protection for transistors, IC, SCR and semiconductor switching components and a variety of electronic, electrical equipment
- Surge absorption and over-voltage protection for household appliances
- Industrial electrical surge absorption
- Electrostatic discharge and noise signal cancellation
- Surge absorption of relays and solenoid valves
- Over-voltage protection for leakage switch
- The lightning protection and over-voltage protection for Telephone program-controlled switches and communications equipment

### Applicable Standard

Approval		Organization	Safety Standards	Certificate No.
China		CQC	GB/T10193 GB/T10194 GB8898-2011 GB4943.1-2011	10D: CQC07001020532
				14D: CQC07001020531
				20D: CQC07001020530
USA Canada		UL	UL 1449	E330837
Germany		VDE	IEC 61051	40023049

## Part Number Code

Inner Management

STE	10	D	471	K	1	E	N0	F	Q	B	0	R	0
-----	----	---	-----	---	---	---	----	---	---	---	---	---	---

**Songtian**  
(STE)

**Product Categories**  
D: (Circular)

**Tolerance**  
K:±10%

**Pitch**  
E:7.5mm  
D:10.0mm

**Package**  
B: Bulk  
T:Tape

**Environmental Standard**  
R: RoHS  
F: RoHS+Halogen-Free

**Core Diameter**  
10:10mm  
14:14mm  
20:20mm

**Foot Type**  
1:Long straight  
2:Outside Crimped  
3:Short Straight  
8:Vertical Crimped

**Style**  
Q: 6KV/3KA

**Lead Material**  
F: Tinned copper clad steel wire  
C:Copper wire

**Nominal Varistor Voltage**  
820:82V  
471:470V  
122:1200V

**Lead Length**  
S0~S9:1.0~1.9mm  
X0~X9:2.0~2.9mm  
A0~A9:3.0~3.9mm  
B0~B9:4.0~4.9mm  
C0~C9:5.0~5.9mm  
D0~D9:6.0~6.9mm  
E0~E9:7.0~7.9mm

**Lead Length**  
F0~F9:8.0~8.9mm  
G0~G9:9.0~9.9mm  
H0~H9:10.0~10.9mm  
J0~J9:11.0~11.9mm  
K0~K9:12.0~12.9mm  
L0~L9:13.0~13.9mm  
M0~M9:14.0~14.9mm

**Lead Length**  
M0~M9:14.0~14.9mm  
N0:16~27.0mm(Bulk)  
**Crimped Lead Taped**  
N0:H0=16.5mm  
P0:H0=17.0mm  
Q0:H0=19.0mm  
**Straight Lead**  
Q0:20.0mm

## Electrical Characteristics

### 10D-Q Series

Part Number	Maximum Allowable Voltage		Varistor Voltage $V_{1mA}$ (V)	Maximum Clamping Voltage		Peak Current Rating(8/20 $\mu$ s)		Maximum Energy (10/1000 $\mu$ s) (J)	Rated Power (W)	Typical Capacitance (Reference) 1KHz (pF)
	AC <sub>rms</sub> (V)	DC <sub>rms</sub> (V)		VC (V)	IP (A)	1 pulse (A)	2 pulse (A)			
STE-10D391KQ	250	320	390(351-429)	650	25	3500	2500	81.2	0.4	300
STE-10D431KQ	275	350	430(387-473)	710	25	3500	2500	68.2	0.4	270
STE-10D471KQ	300	385	470(423-517)	775	25	3500	2500	99.4	0.4	230
STE-10D511KQ	320	415	510(459-561)	845	25	3500	2500	99.4	0.4	210
STE-10D561KQ	350	460	560(504-616)	925	25	3500	2500	99.4	0.4	180
STE-10D621KQ	385	505	620(558-682)	1025	25	3500	2500	102.2	0.4	190
STE-10D681KQ	420	560	680(612-748)	1120	25	3500	2500	102.2	0.4	170
STE-10D751KQ	460	615	750(675-825)	1240	25	3500	2500	124.6	0.4	160
STE-10D821KQ	510	670	820(738-902)	1355	25	3500	2500	124.6	0.4	140
STE-10D911KQ	550	745	910(819-1001)	1500	25	3500	2500	133	0.4	120
STE-10D102KQ	625	825	1000(900-1100)	1650	25	3500	2500	133	0.4	110
STE-10D112KQ	680	895	1100(990-1210)	1815	25	3500	2500	155	0.4	90

## 14D-Q Series

Part Number	Maximum Allowable Voltage		Varistor Voltage $V_{1mA}$ (V)	Maximum Clamping Voltage		Peak Current Rating(8/20 $\mu$ s)		Maximum Energy (10/1000 $\mu$ s) (J)	Rated Power (W)	Typical Capacitance (Reference) 1KHz (pF)
	AC <sub>rms</sub> (V)	DC <sub>rms</sub> (V)		VC (V)	IP (A)	1 pulse (A)	2 pulse (A)			
STE-14D820KQ	50	65	82(74-90)	135	50	6000	4500	29.4	0.6	3700
STE-14D101KQ	60	85	100(90-110)	165	50	6000	4500	33.6	0.6	3200
STE-14D121KQ	75	100	120(108-132)	200	50	6000	4500	40.6	0.6	2700
STE-14D151KQ	95	125	150(135-165)	250	50	6000	4500	51.8	0.6	2200
STE-14D181KQ	115	150	180(162-198)	300	50	6000	4500	58.8	0.6	1100
STE-14D201KQ	130	170	200(180-220)	340	50	6000	4500	79.8	0.6	770
STE-14D221KQ	140	180	220(198-242)	360	50	6000	4500	79.8	0.6	740
STE-14D241KQ	150	200	240(216-264)	395	50	6000	4500	82.6	0.6	700
STE-14D271KQ	175	225	270(243-297)	455	50	6000	4500	93.8	0.6	640
STE-14D301KQ	190	250	300(270-330)	500	50	6000	4500	103.6	0.6	670
STE-14D331KQ	210	275	330(297-363)	550	50	6000	4500	112	0.6	580
STE-14D361KQ	230	300	360(324-396)	595	50	6000	4500	123.2	0.6	540
STE-14D391KQ	250	320	390(351-429)	650	50	6000	4500	134.4	0.6	500
STE-14D431KQ	275	350	430(387-473)	710	50	6000	4500	145.6	0.6	450
STE-14D471KQ	300	385	470(423-517)	775	50	6000	4500	149.8	0.6	400
STE-14D511KQ	320	415	510(459-561)	845	50	6000	4500	149.8	0.6	350
STE-14D561KQ	350	460	560(504-616)	925	50	6000	4500	149.8	0.6	360
STE-14D621KQ	385	505	620(558-682)	1025	50	6000	4500	168	0.6	330
STE-14D681KQ	420	560	680(612-748)	1120	50	6000	4500	168	0.6	320
STE-14D751KQ	460	615	750(675-825)	1240	50	6000	4500	203	0.6	310
STE-14D781KQ	485	640	780(702-858)	1290	50	6000	4500	203	0.6	260
STE-14D821KQ	510	670	820(738-902)	1355	50	6000	4500	203	0.6	280
STE-14D911KQ	550	745	910(819-1001)	1500	50	6000	4500	217	0.6	250
STE-14D102KQ	625	825	1000(900-1100)	1650	50	6000	4500	217	0.6	230
STE-14D112KQ	680	895	1100(990-1210)	1815	50	6000	4500	310	0.6	180

## 20D-Q Series

Part Number	Maximum Allowable Voltage		Varistor Voltage	Maximum Clamping Voltage			Peak Current Rating(8/20 $\mu$ s)		Maximum Energy (10/1000 $\mu$ s) (J)	Rated Power (W)	Typical Capacitance (Reference) 1KHz (pF)
	AC <sub>rms</sub> (V)	DC <sub>rms</sub> (V)		V <sub>1mA</sub> (V)	VC (V)	IP (A)	1 pulse (A)	2 pulse (A)			
STE-20D820KQ	50	65	82(74-90)	135	100	10000	6500	37.8	1.0	7500	
STE-20D101KQ	60	85	100(90-110)	165	100	10000	6500	42	1.0	6500	
STE-20D121KQ	75	100	120(108-132)	200	100	10000	6500	56	1.0	5500	
STE-20D151KQ	95	125	150(135-165)	250	100	10000	6500	70	1.0	4500	
STE-20D181KQ	115	150	180(162-198)	300	100	10000	6500	84	1.0	2200	
STE-20D201KQ	130	170	200(180-220)	340	100	10000	6500	98	1.0	1700	
STE-20D221KQ	140	180	220(198-242)	360	100	10000	6500	105	1.0	1600	
STE-20D241KQ	150	200	240(216-264)	395	100	10000	6500	112	1.0	1500	
STE-20D271KQ	175	225	270(243-297)	455	100	10000	6500	126	1.0	1300	
STE-20D301KQ	190	250	300(270-330)	500	100	10000	6500	133	1.0	1300	
STE-20D331KQ	210	275	330(297-363)	550	100	10000	6500	140	1.0	1100	
STE-20D361KQ	230	300	360(324-396)	595	100	10000	6500	168	1.0	1100	
STE-20D391KQ	250	320	390(351-429)	650	100	10000	6500	182	1.0	1100	
STE-20D431KQ	275	350	430(387-473)	710	100	10000	6500	196	1.0	1000	
STE-20D471KQ	300	385	470(423-517)	775	100	10000	6500	210	1.0	900	
STE-20D511KQ	320	415	510(459-561)	845	100	10000	6500	210	1.0	800	
STE-20D561KQ	350	460	560(504-616)	925	100	10000	6500	210	1.0	710	
STE-20D621KQ	385	505	620(558-682)	1025	100	10000	6500	224	1.0	700	
STE-20D681KQ	420	560	680(612-748)	1120	100	10000	6500	224	1.0	650	
STE-20D751KQ	460	615	750(675-825)	1240	100	10000	6500	266	1.0	600	
STE-20D781KQ	485	640	780(702-858)	1290	100	10000	6500	440	1.0	510	
STE-20D821KQ	510	670	820(738-902)	1355	100	10000	6500	266	1.0	530	
STE-20D911KQ	550	745	910(819-1001)	1500	100	10000	6500	280	1.0	500	
STE-20D102KQ	625	825	1000(900-1100)	1650	100	10000	6500	280	1.0	450	
STE-20D112KQ	680	895	1100(990-1210)	1815	100	10000	6500	620	1.0	360	

## Dimensions (mm) and Approval

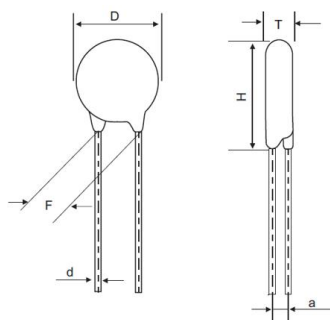

### 10D-Q Series

Part No.	Size (mm)				Approval			
	D Max.	T Max.	F±0.8	d±0.05	CQC	VDE	UL (USA)	cUL (Canada)
STE-10D391KQ	13.5	5.5	7.5	0.7	√	√	√	√
STE-10D431KQ	13.5	6.0	7.5	0.7	√	√	√	√
STE-10D471KQ	13.5	6.0	7.5	0.7	√	√	√	√
STE-10D511KQ	13.5	6.5	7.5	0.7	√	√	√	√
STE-10D561KQ	13.5	6.5	7.5	0.7	√	√	√	√
STE-10D621KQ	13.5	7.0	7.5	0.7	√	√	√	√
STE-10D681KQ	13.5	7.5	7.5	0.7	√	√	√	√
STE-10D751KQ	13.5	7.5	7.5	0.7	√	√	√	√
STE-10D821KQ	13.5	8.0	7.5	0.7	√	√	√	√
STE-10D911KQ	13.5	8.5	7.5	0.7	√	√	√	√
STE-10D102KQ	13.5	9.0	7.5	0.7	√	√	√	√
STE-10D112KQ	13.5	10.0	7.5	0.7	√		√	√

## 14D-Q Series

Part No.	Size (mm)				Approval			
	D Max.	T Max.	F±0.8	d±0.05	CQC	VDE	UL (USA)	cUL (Canada)
STE-14D820KQ	16.5	4.0	7.5	0.7	√	√	√	√
STE-14D101KQ	16.5	4.0	7.5	0.7	√	√	√	√
STE-14D121KQ	16.5	4.0	7.5	0.7	√	√	√	√
STE-14D151KQ	16.5	4.5	7.5	0.7	√	√	√	√
STE-14D181KQ	16.5	4.5	7.5	0.7	√	√	√	√
STE-14D201KQ	16.5	4.5	7.5	0.7	√	√	√	√
STE-14D221KQ	16.5	5.0	7.5	0.7	√	√	√	√
STE-14D241KQ	16.5	4.5	7.5	0.7	√	√	√	√
STE-14D271KQ	16.5	4.5	7.5	0.7	√	√	√	√
STE-14D301KQ	16.5	5.0	7.5	0.7	√	√	√	√
STE-14D331KQ	16.5	5.0	7.5	0.7	√	√	√	√
STE-14D361KQ	16.5	5.0	7.5	0.7	√	√	√	√
STE-14D391KQ	16.5	5.0	7.5	0.7	√	√	√	√
STE-14D431KQ	16.5	5.5	7.5	0.7	√	√	√	√
STE-14D471KQ	16.5	5.5	7.5	0.7	√	√	√	√
STE-14D511KQ	16.5	6.0	7.5	0.7	√	√	√	√
STE-14D561KQ	16.5	6.0	7.5	0.7	√	√	√	√
STE-14D621KQ	16.5	6.5	7.5	0.7	√	√	√	√
STE-14D681KQ	16.5	6.5	7.5	0.7	√	√	√	√
STE-14D751KQ	16.5	7.0	7.5	0.7	√	√	√	√
STE-14D781KQ	16.5	7.0	7.5	0.7			√	√
STE-14D821KQ	16.5	7.5	7.5	0.7	√	√	√	√
STE-14D911KQ	16.5	7.5	7.5	0.7	√	√	√	√
STE-14D102KQ	16.5	8.0	7.5	0.7	√	√	√	√
STE-14D112KQ	16.5	8.5	7.5	0.7	√		√	√

## 20D-Q Series

Part No.	Size (mm)					Approval			
	D Max.	T Max.	F±0.8	d±0.05		CQC	VDE	UL (USA)	cUL (Canada)
				Straight lead	Crimped lead				
STE-20D820KQ	23.0	4.0	10.0	1.0	0.7	√	√	√	√
STE-20D101KQ	23.0	4.5	10.0	1.0	0.7	√	√	√	√
STE-20D121KQ	23.0	4.5	10.0	1.0	0.7	√	√	√	√
STE-20D151KQ	23.0	5.0	10.0	1.0	0.7	√	√	√	√
STE-20D181KQ	23.0	5.0	10.0	1.0	0.7	√	√	√	√
STE-20D201KQ	23.0	5.0	10.0	1.0	0.7	√	√	√	√
STE-20D221KQ	23.0	5.5	10.0	1.0	0.7	√	√	√	√
STE-20D241KQ	23.0	5.0	10.0	1.0	0.7	√	√	√	√
STE-20D271KQ	23.0	5.0	10.0	1.0	0.7	√	√	√	√
STE-20D301KQ	23.0	5.5	10.0	1.0	0.7	√	√	√	√
STE-20D331KQ	23.0	5.5	10.0	1.0	0.7	√	√	√	√
STE-20D361KQ	23.0	5.5	10.0	1.0	0.7	√	√	√	√
STE-20D391KQ	23.0	5.5	10.0	1.0	0.7	√	√	√	√
STE-20D431KQ	23.0	6.0	10.0	1.0	0.7	√	√	√	√
STE-20D471KQ	23.0	6.0	10.0	1.0	0.7	√	√	√	√
STE-20D511KQ	23.0	6.5	10.0	1.0	0.7	√	√	√	√
STE-20D561KQ	23.0	6.5	10.0	1.0	0.7	√	√	√	√
STE-20D621KQ	23.0	7.0	10.0	1.0	0.7	√	√	√	√
STE-20D681KQ	23.0	7.0	10.0	1.0	0.7	√	√	√	√
STE-20D751KQ	23.0	7.5	10.0	1.0	0.7	√	√	√	√
STE-20D781KQ	23.0	7.5	10.0	1.0	0.7			√	√
STE-20D821KQ	23.0	8.0	10.0	1.0	0.7	√	√	√	√
STE-20D911KQ	23.0	8.5	10.0	1.0	0.7	√	√	√	√
STE-20D102KQ	23.0	8.5	10.0	1.0	0.7	√	√	√	√
STE-20D112KQ	23.0	9.0	10.0	1.0	0.7	√		√	√

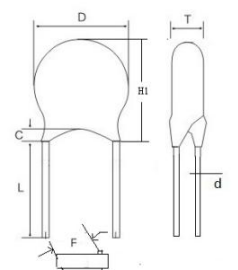
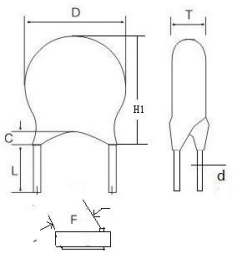
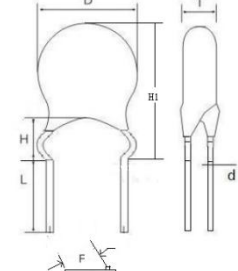
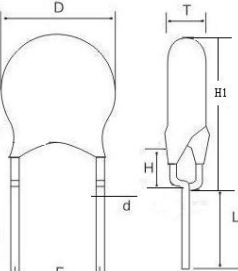

## Lead Configuration

Lead Style	Drawing	Lead Length L (mm)	Coating Lead Length C (mm)	Height H (mm)
Long Straight		16.0 min	3.0 Max	/
Short Straight		①[2.5≤L < 6.0]±0.5; ②[6.0≤L≤10]±1.0	3.0 Max	/
Outside Crimped		①[2.5≤L < 6.0]±0.5; ②[6.0≤L≤10]±1.0	Not exceed the bend point	5.5mm Max
Vertical Crimped		①[2.5≤L < 6.0]±0.5; ②[6.0≤L≤10]±1.0	Not exceed the bend point	4.5mm Max

## Taping And Dimensions (mm)

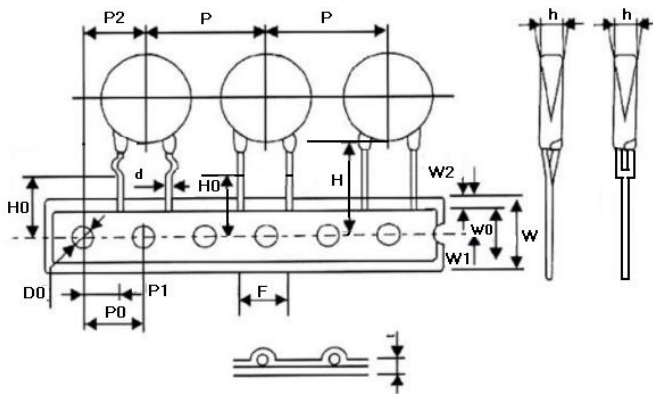
Figure	Symbol	P=7.5		P=10.0		
	Po	12.7±0.3		12.7±0.3		
	P	25.4±1.0		25.4±1.0		
	P1	8.95±0.7		7.7±0.7		
	P2	12.7±1.3		12.7±1.3		
	F	7.5±0.8		10.0±0.8		
	Δh	0±2.0		0±2.0		
	W	18.0 +1.5/-1.0		18.0 +1.5/-1.0		
	Wo	10.5 Max		10.5 Max		
	W1	9.0+0.75/-0.5		9.0+0.75/-0.5		
	W2	3.0 Max		3.0 Max		
	Do	4.0±0.2		4.0±0.2		
	H	20+1.5/-1.0		20+1.5/-1.0		
	Ho	16.5&17.0&19.0 +1.5/-1.0		16.5&17.0&19.0 +1.5/-1.0		
	L	Straight Lead			Straight Lead	
		Crimped Lead			Crimped Lead	
			11.0 Max	9.0 Max	11.0 Max	9.0 Max
	t1	0.5±0.2		0.5±0.2		
t2	1.7 Max		1.7 Max			

## X-ON Electronics

Largest Supplier of Electrical and Electronic Components

*Click to view similar products for [Varistors](#) category:*

*Click to view products by [Songtian](#) manufacturer:*

Other Similar products are found below :

[820443211E](#) [MLV0402E30703T](#) [MLV0603E30403T](#) [B72205S271K111](#) [B72207S350K311](#) [B72207S381K101](#) [B72260B102K1](#)  
[B72260B251K1](#) [B72280B0381K001](#) [B72280B0461K001](#) [B72280B271K1](#) [B72650M0151K093](#) [B72660M0271K093](#) [S10K11G5S5](#) [ERZ-](#)  
[C07DK221U](#) [TND10V-471KB00AAA0](#) [B72205S301K211](#) [B72207S141K111](#) [B72210S271K111](#) [B72214S350K551](#) [B72220P3351K101](#)  
[B72280B0231K001](#) [B72280B112K1](#) [B72280B381K1](#) [B72590D360A60](#) [B72650M0400K072](#) [B72650M0500K072](#) [B72660M0200K072](#)  
[B72660M1300K072](#) [B72670M1140K72](#) [MLV0603E30703T](#) [MLV0603E32503T](#) [TVZ18EC271KBS](#) [TVZ20EB911KBS](#) [TVZ25D201KBS](#)  
[TVZ25D241KBS](#) [419-2080-101](#) [ERZ-V20R201](#) [MLV0805E31103T](#) [MLV0805E30703T](#) [ERZ-V20R221](#) [B72205S350K211](#)  
[B72210P2511K101](#) [B72214S271K501](#) [B72220P3551K101](#) [B72240B681K1](#) [B72650M350K72](#) [TVZ20ECN511KBS](#) [TVZ20EC911KBS](#)  
[TVZ20EBN911KBS](#)