

MOLDING POWER INDUCTOR.

Features:

- Low profile and low DCR.
- Shielded construction.
- handles high transient current spikes without saturation
- frequency up to 3MHz
- Ultra Low buzz noise, due to composite construction
- 100% lead (Pb) free meet RoHS standard

Applications

- PDA/Notebook/Desktop, and server applications.
- low profile,high current power supplies.
- Battery powered devices.
- DC/DC converters.



Product Dimensions [unit: inch/ mm]:

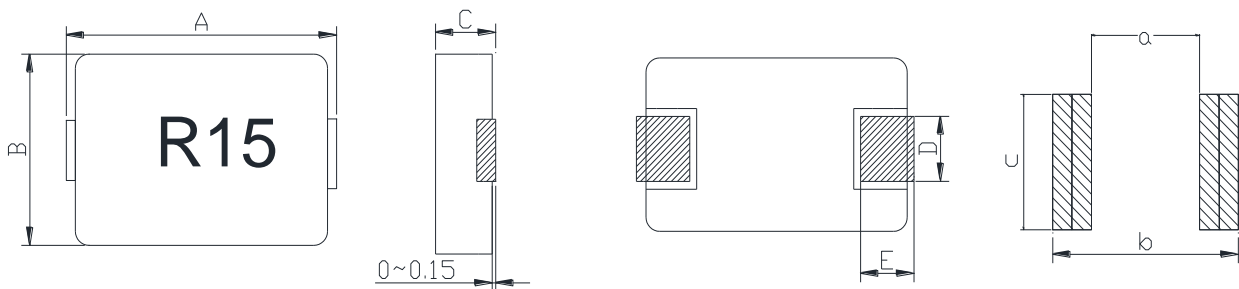

Product Dimensions

A	B	C	D	E	a	b	c
12.80	7.80	4.20	3.50	2.50	6.00	14.50	5.00
±0.40	±0.40	MAX	±0.50	±0.50	TYP	TYP	TYP

PART NUMBERING SYSTEM:

<u>SMIS</u>	<u>130804</u>	<u>XXXX</u>	<u>XXXX</u>
1	2	3	4

1.SERIES NAME

2.DIMENSIONS

3.INDUCTANCE

4.TOLERANCE CODE: J: ±5% K: ±10% L: ±15% M: ±20% P: ±25% N: ±30%

Test instruments :

L tested by Wayne kerr 3260B LCR meter with Wayne kerr 3265B bias current source.

DCR tested by Milli-ohm meter.

MATERIAL LIST:

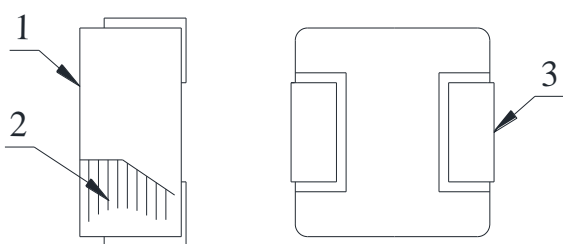

No	Part	Material
1	CORE	Carbonyl powder
2	WIRE	Copper wire
3	BASE	copper
Surface spray paint treatment		

Electrical characteristics for MPIB130840 series:

P/N	100KHz 1.0V	D.C.R (mΩ)		Saturation Current	Heat Rating Current
	L0(μH) ±20%	Typical	Max	I sat (Amp) Typical	I rms (Amp) Typical
SMIS130804-R15M	0.15	0.41	0.55	85.00	45.00
SMIS130804-R22M	0.22	0.45	0.60	80.00	45.00
SMIS130804-R33M	0.33	1.12	1.30	70.00	35.00
SMIS130804-R47M	0.47	1.12	1.30	60.00	35.00

- All test data is referenced to 25°C ambient
- DC current (I_{rms}) that will cause an approximate Δ T of 40°C
- DC current (I_{sat}) that will cause L₀ to drop approximately 30%
- Operating temperature Range: -55°C to +125°C
- Absolute maximum voltage 30VDC
- Operating temperature range - 55°C ~ 125°C (Including self - temperature rise)

Typical performance curves:

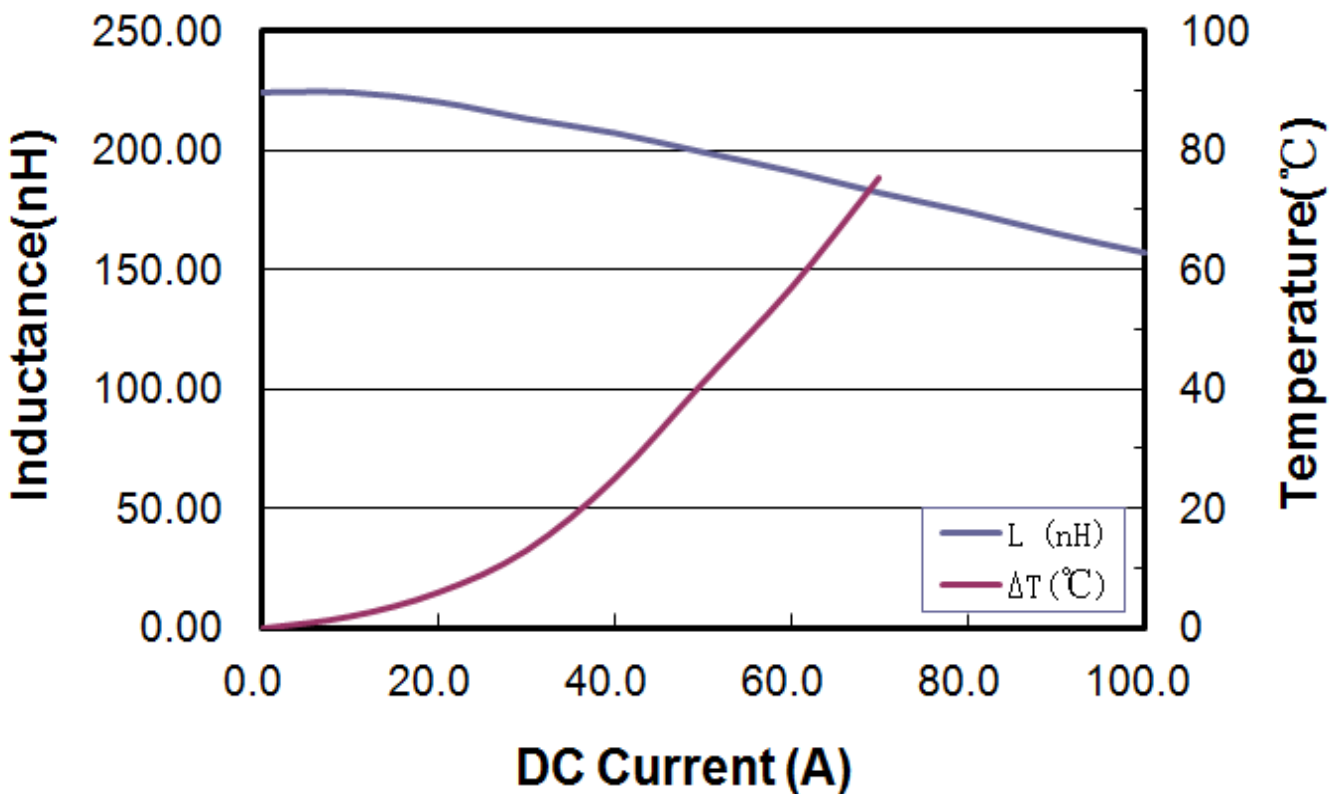
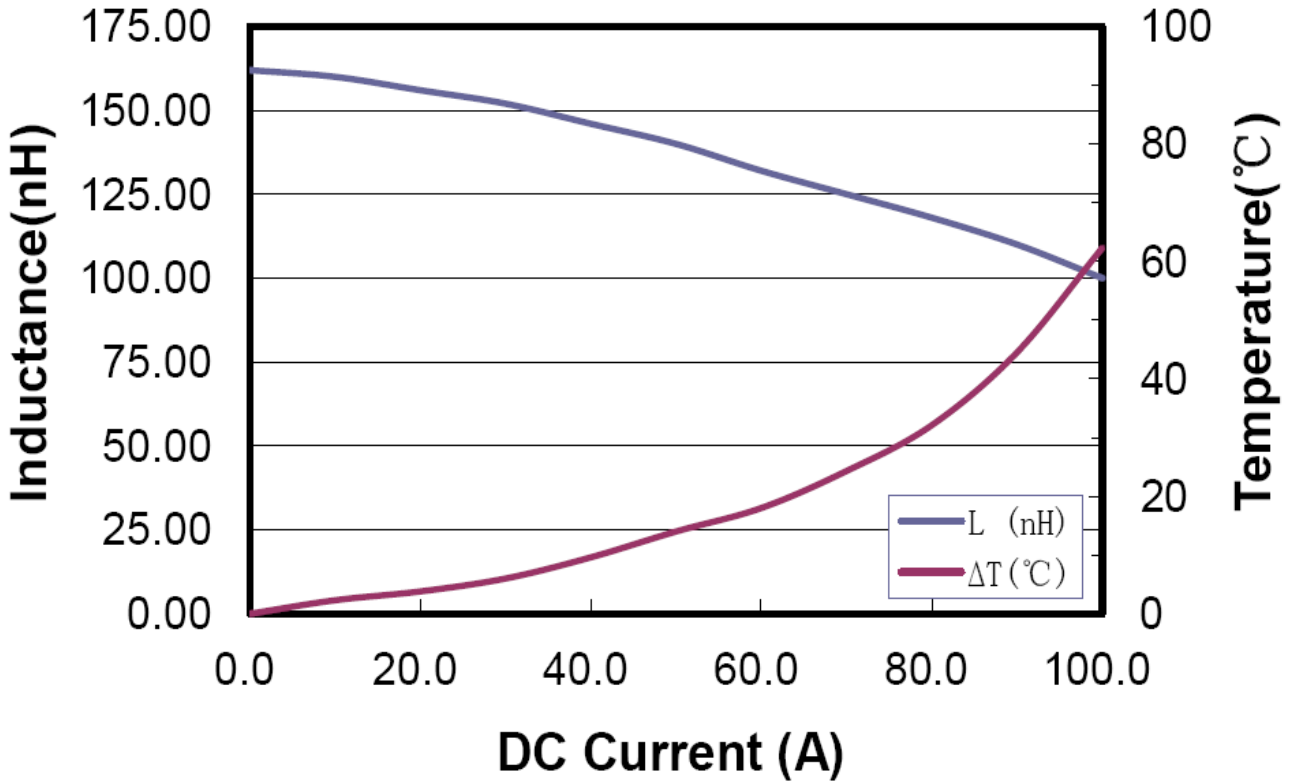

Typical performance curves:

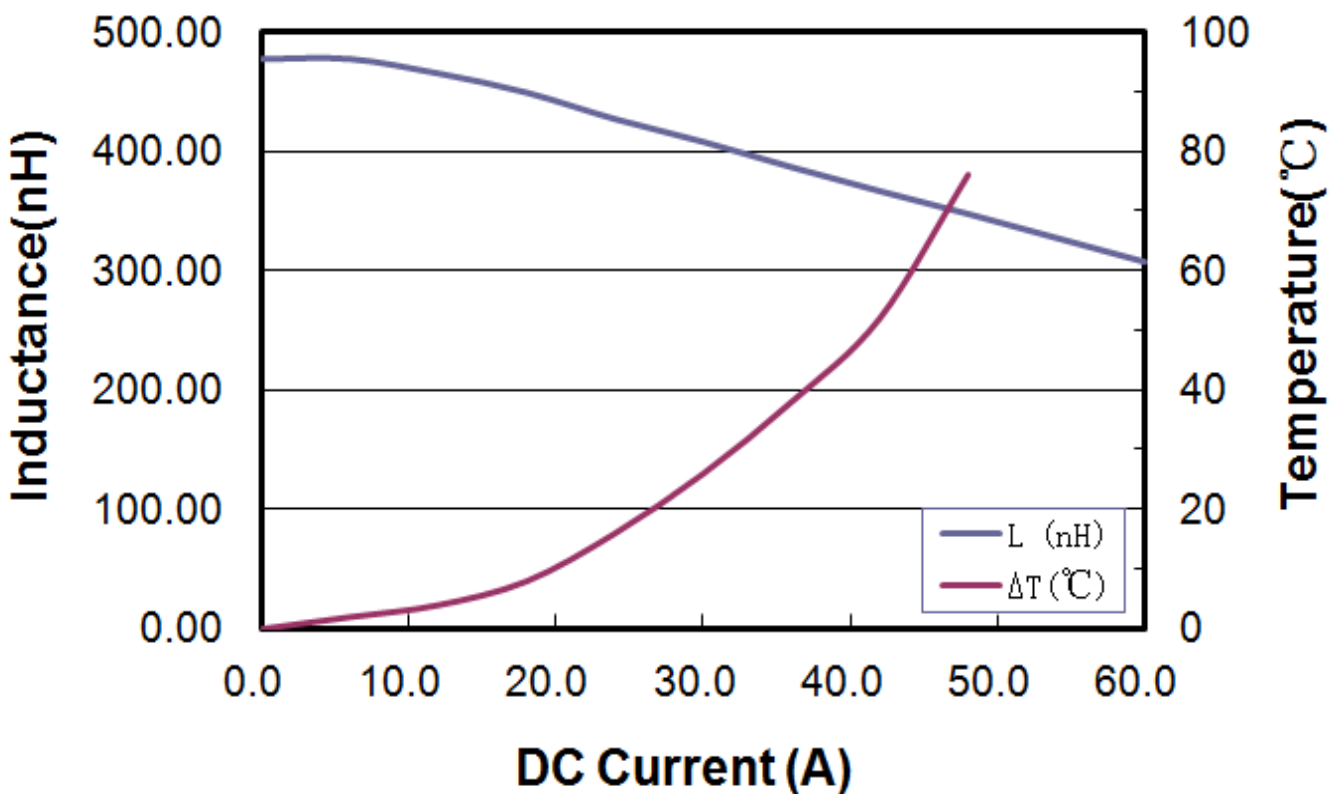
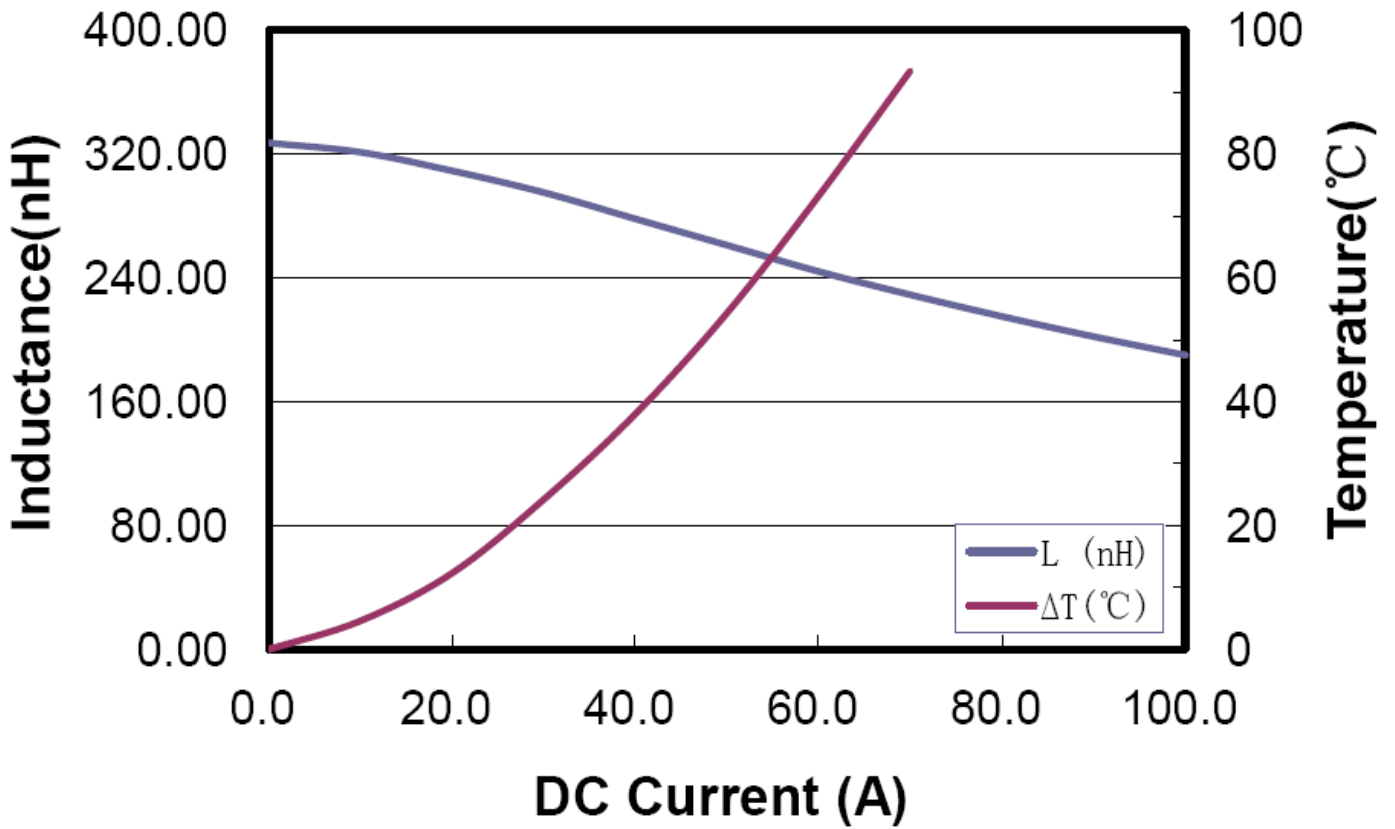

DIMENSIONS FOR CARRIER TAPES (unit:mm)

ITEM	W	A0	B0	K0	P	F	E	D0	D1	P0	P2	T
DIM	24.00 ±0.3	8.30 ±0.3	13.6 ±0.3	4.20 ±0.3	12.00 ±0.1	11.50 ±0.1	1.75 ±0.1	1.50 ±0.1	1.50 ±0.1	4.00 ±0.1	2.00 ±0.1	0.35 ±0.1

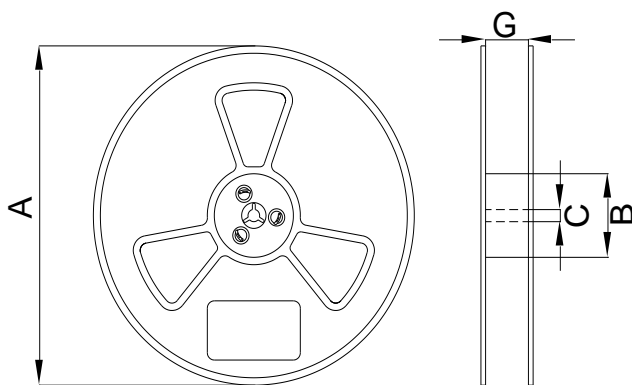
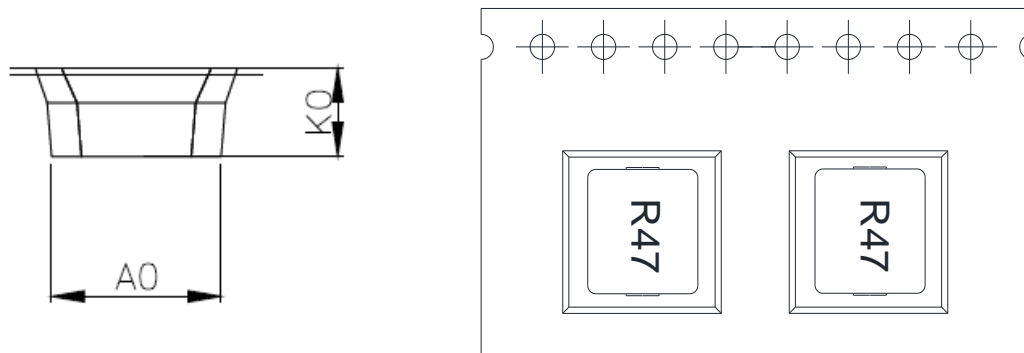
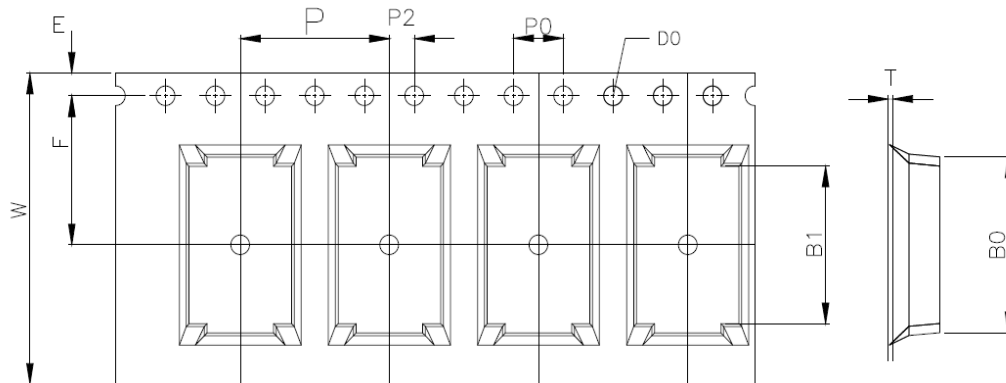

REEL SPEC	13"
A±1.0	330.0
B±1.0	100.0
C±0.50	13.2
G±0.20	24.5

PACKING(mm)

载带宽度 (W)	间距 (P)	卷(PCS) 13inch	2卷/内箱 (PCS)	3内箱/外箱 (PCS)	产品单重
24	12	1000	2000	6000	2.40g/pcs

Product application examples

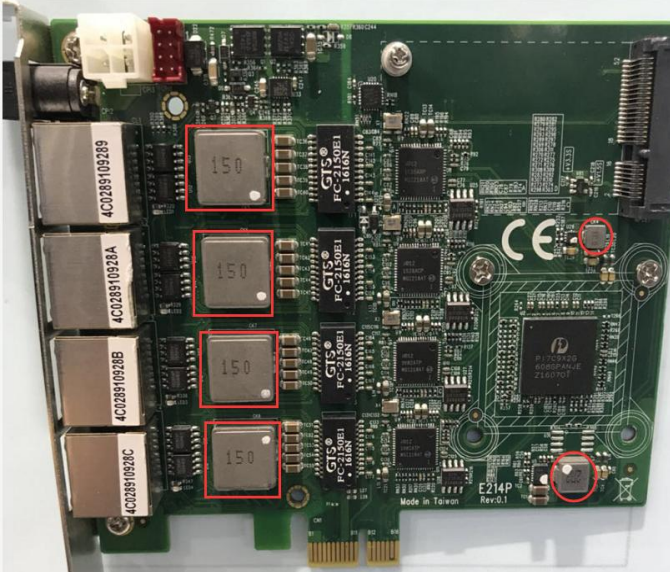

网络扩展卡

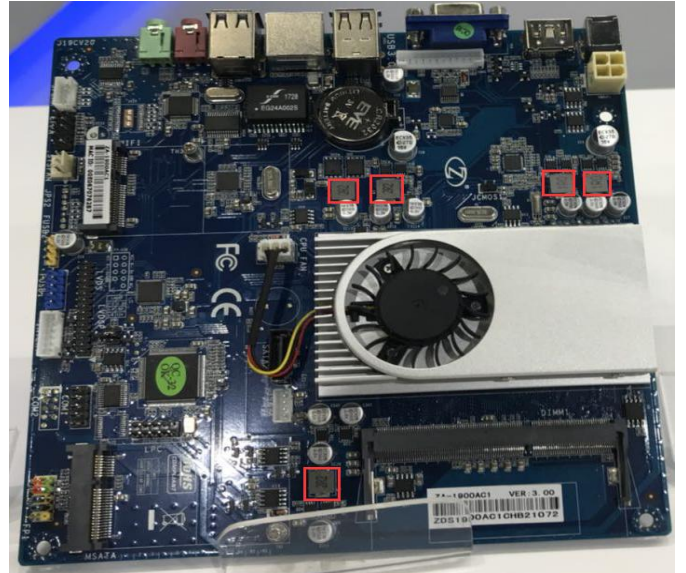

电脑主板 (一)



电源卡-电池充电

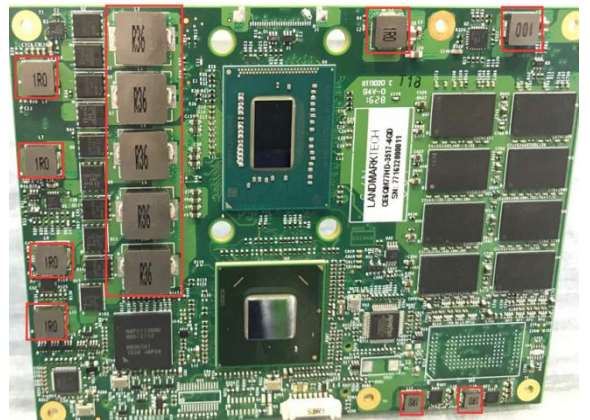

工业主板 (二)

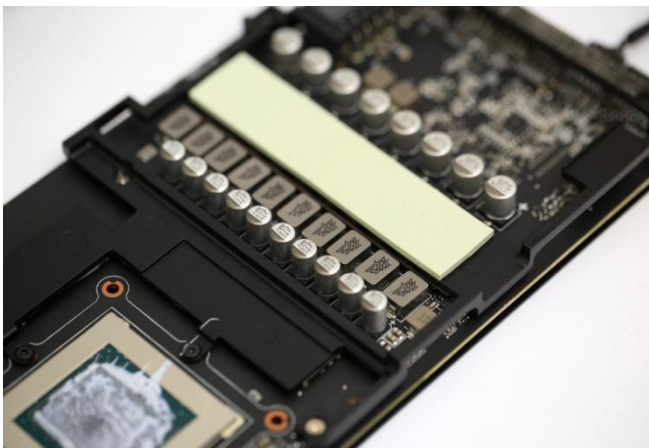

显示卡 (一)

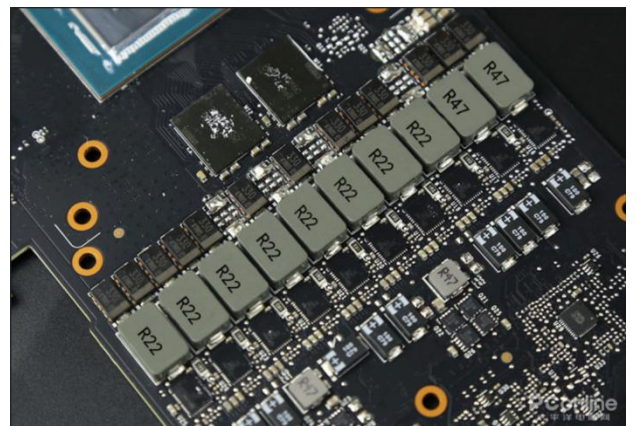

显示卡 (二)

X-ON Electronics

Largest Supplier of Electrical and Electronic Components

Click to view similar products for [Fixed Inductors](#) category:

Click to view products by [SXN](#) manufacturer:

Other Similar products are found below :

[MLZ1608M6R8WTD25](#) [MLZ1608N6R8LT000](#) [MLZ1608N3R3LTD25](#) [MLZ1608N3R3LT000](#) [MLZ1608N150LT000](#)
[MLZ1608M150WTD25](#) [MLZ1608M3R3WTD25](#) [MLZ1608M3R3WT000](#) [MLZ1608M150WT000](#) [MLZ1608A1R5WT000](#)
[MLZ1608N1R5LT000](#) [B82432C1333K000](#) [PCMB053T-1R0MS](#) [PCMB053T-1R5MS](#) [PCMB104T-1R5MS](#) [CR32NP-100KC](#) [CR32NP-151KC](#) [CR32NP-180KC](#) [CR32NP-181KC](#) [CR32NP-1R5MC](#) [CR32NP-390KC](#) [CR32NP-3R9MC](#) [CR32NP-680KC](#) [CR32NP-820KC](#)
[CR32NP-8R2MC](#) [CR43NP-390KC](#) [CR43NP-560KC](#) [CR43NP-680KC](#) [CR54NP-181KC](#) [CR54NP-470LC](#) [CR54NP-820KC](#) [CR54NP-8R5MC](#)
[MGDQ4-00004-P](#) [MGDU1-00016-P](#) [MHL1ECTTP18NJ](#) [MHL1JCTTD12NJ](#) [PE-51506NL](#) [PE-53601NL](#) [PE-53630NL](#) [PE-53824SNLT](#) [PE-62892NL](#) [PE-92100NL](#) [PG0434.801NLT](#) [PG0936.113NLT](#) [PM06-2N7](#) [PM06-39NJ](#) [HC2LP-R47-R](#) [HC2-R47-R](#) [HC3-2R2-R](#) [HC8-1R2-R](#)