

SPECIFICATIONS FOR APPROVAL



Customer Part No.: _____ HELE. Part No: X2C024000B71H-V
Application For: _____ Products: CRYSTAL
Accepted Model: _____ Type & Freq.: HSX211S / 24.000MHz
Sample Order No: EOS-G50030-2 Date: 2016/05/04

Approved By :

加高電子股份有限公司
加高電子股份有限公司

HARMONY ELECTRONICS CORP.

HARMONY ELECTRONICS (THAILAND) CO., LTD.

HARMONY ELECTRONICS (SHENZHEN) CORP., LTD.

TAIPEI OFFICE:

公司:(114)
台北市內湖區堤頂大道2段409號2樓
2F., NO.409, SEC.2, TIDING BLVD.,
NEIHU DISTRICT, TAIPEI CITY 114,
TAIWAN
TEL:886-2-26588883
FAX:886-2-26588683

TAIWAN FACTORY:

工廠:(831)
高雄市大寮區大發工業區華東路39號
No.39, HWA DONG RD., DALLIAO
DIST.,DAFA INDUSTRIAL PARK.,
KAOHSIUNG CITY 831, TAIWAN
TEL: (07)787-1555-6
FAX: (07)787-1557

THAILAND FACTORY:

66MOO 5, KAONGU-BEOKPRAI RD.,
T.BEOKPRAI, A. BANPONG,
RAJCHABUREE PROVINCE 70110,
THAILAND
TEL: (032)221994-6,
200740-1
FAX: (032)200742

SHENZHEN FACTORY:

深圳市福永鎮塘尾村橋塘路聚源工業區
QIAO TANG RD., TANGWEI VILLAGE
FU YONG TOWN SHENZHEN CITY
CHINA
TEL: 0755-27309272 /
27309262
FAX: 0755-27309755

Title HSX211S QUARTZ CRYSTAL SPECIFICATION				Country of origin TAIWAN FACTORY THAILAND FACTORY CHINA FACTORY		
Date	Confirm	Check	Prepare	Spec. No.	Rev.	Page
2016/05/04	F. S. TSAI	Y. W. LEE	U. F. CHEN	X2C024000B71H-V	0	1

HARMONY ELECTRONICS CORP.

HSX211S SPECIFICATION

INDEX

ITEM	PAGE
1. QUARTZ CRYSTAL UNIT SPECIFICATION	3
2. MARKING & DIMENSIONS	4
3. INSIDE STRUCTURE	5
4. EMBOSS CARRIER TAPE&REEL	
a. DIMENSIONS OF CARRIER TAPE	6
b. DIMENSIONS OF REEL	6-7
c. STORAGE CONDITION	7
d. STANDARD PACKING QUANTITY	7
e. MATERIAL OF TAPE	7
f. LABEL CONTENTS	7
g. TAPING DIMENSION	8
h. JOINT OF TAPE	8
i. RELEASE STRENGTH OF COVER TAPE	8
j. PACKAGE	9
5. MECHANICAL ENDURANCE	10
6. ENVIRONMENTAL ENDURANCE	11
7. SUPPLEMENT	12-13
8. Flow Chart	14

Title HSX211S QUARTZ CRYSTAL SPECIFICATION				Country of origin TAIWAN FACTORY THAILAND FACTORY CHINA FACTORY		
Date	Confirm	Check	Prepare	Spec. No.	Rev.	Page
2016/05/04	F. S. TSAI	Y. W. LEE	U. F. CHEN	X2C024000B71H-V	0	2

1. QUARTZ CRYSTAL UNIT SPECIFICATION

- | | |
|--------------------------------|---|
| 1. Frequency: | 24.000000MHz |
| 2. Holder type : | HSX211S |
| 3. Frequency tolerance: | +/- 10ppm at 25deg.C +/-3deg.C |
| 4. Equivalent resistance: | 100 ohms Max. / SERIES |
| 5. Storage temperature range: | -40 deg.C To +125 deg.C |
| 6. Operable temperature range: | -40 deg.C To +85 deg.C |
| 7. Temperature drift: | +/-30 ppm -40 deg.C To +85 deg.C |
| 8. Loading capacitance (CL) : | 12.5 pF |
| 9. Drive level: | 10μW (100uW Max.) |
| 10. Shunt Capacitance: | 2.0 pF Max. |
| 11. Insulation resistance : | More than 500M ohms at DC 100V |
| 12. Mode of oscillation: | Fundamental |
| 13. Circuit: | Measured in HP/E5100A,S&A 250B |
| 14. Shocking : | Dropping from 120 cm height 3 times on Concrete floor |
| Variation : | Frequency less than +/-5 ppm
Resistance less than +/- 15 % or 2ohms max. |
| 15. Aging: | Less than +/- 3 ppm/Year |
| 16. Holder | HSX211S Seam type |
| 17. Dimensions and marking | Refer to page.4 |
| 18. Emboss carrier tape & reel | Refer to page.6 and page.7 |
| 19. Moisture Sensitivity Level | Level 1 |
| 20. Note : | |

Title HSX211S QUARTZ CRYSTAL SPECIFICATION				Country of origin TAIWAN FACTORY THAILAND FACTORY CHINA FACTORY		
Date	Confirm	Check	Prepare	Spec. No.	Rev.	Page
2016/05/04	F. S. TSAI	Y. W. LEE	U. F. CHEN	X2C024000B71H-V	0	3

2. HSX211S MARKING & DIMENSIONS

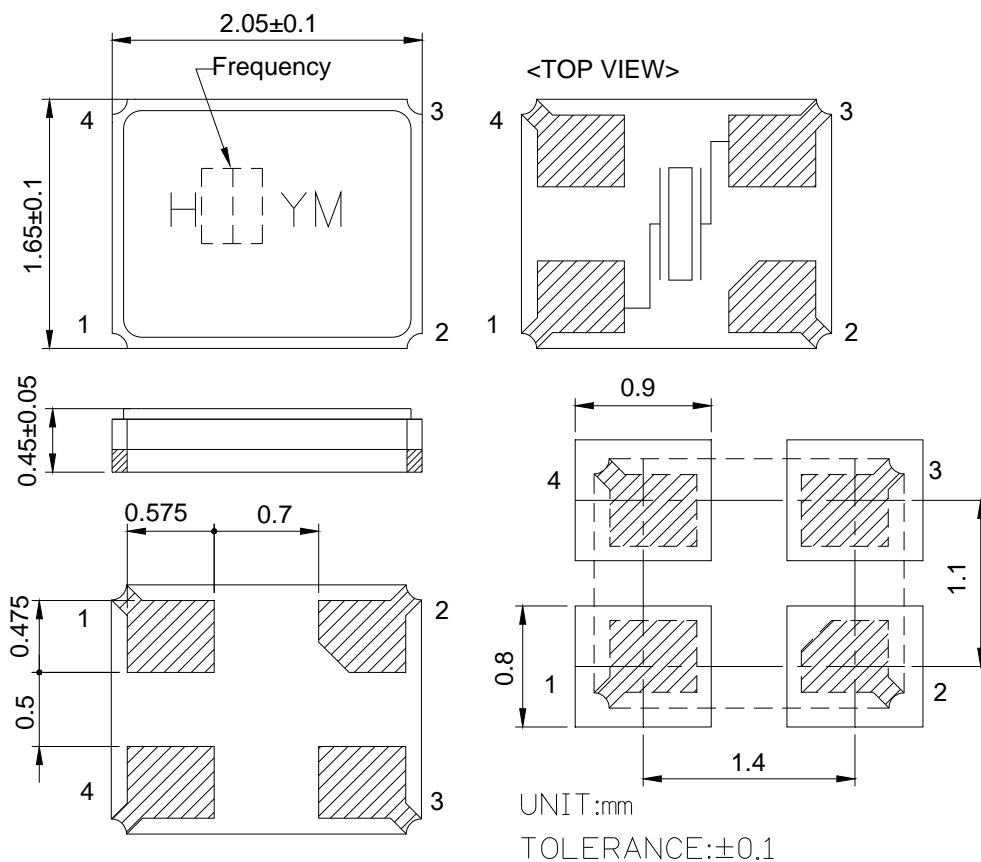

Chamfer index mark depends on the ceramic base supplier.

*Marking should be printed as following:

Logo, Nominal Frequency, Manufactured year & month

*Nominal frequency = integer only

(ex. 14.31818 MHz → 14)

*Manufacturing Lot No.

(Y: year) ex. 2000 shall be marked as ' 0 ' (As shown on the Table-1)

(M: month) ex. June shall be marked as ' F ' (As shown on the Table-2).

Marking : Laser marking.

(Table-1)

Year	2000	2001	2002	2003	2004	2005	2006	2007	2008	2009
	2010	2011	2012	2013	2014	2015	2016	2017	2018	2019
Code	0	1	2	3	4	5	6	7	8	9

(Table-2)

Jan.	Feb.	Mar.	Apr.	May.	Jun.	Jul.	Aug.	Sep.	Oct.	Nov.	Dec.
A	B	C	D	E	F	G	H	J	K	L	M

Title **HSX211S**

QUARTZ CRYSTAL SPECIFICATION

Country of origin

TAIWAN FACTORY
THAILAND FACTORY
CHINA FACTORY

Date

Confirm

Check

Prepare

Spec. No.

Rev.

Page

2016/05/04

F. S. TSAI

Y. W. LEE

U. F. CHEN

X2C024000B71H-V

0

4

HARMONY ELECTRONICS CORP.

3. INSIDE STRUCTURE

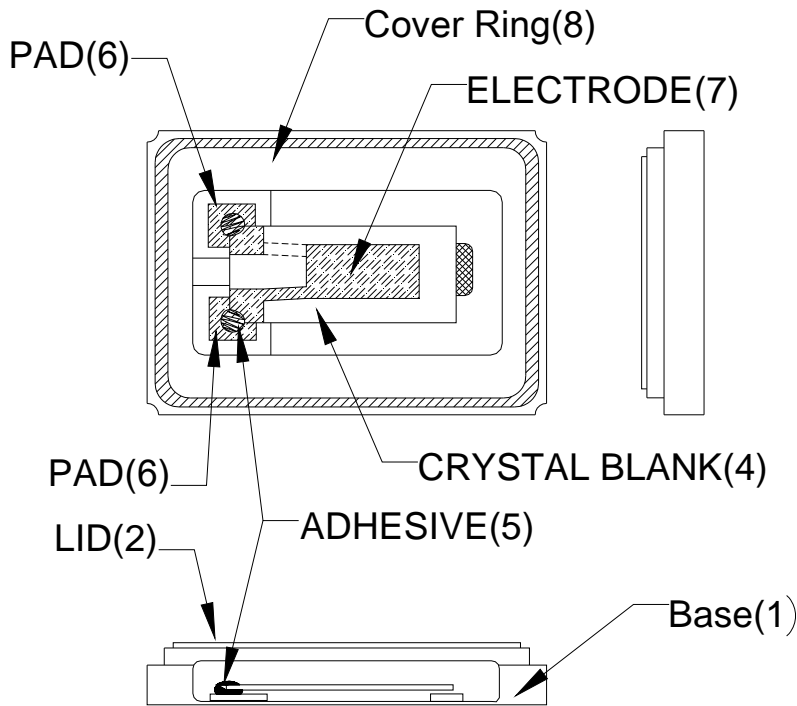

※Reference drawing

(1) Base: Alumina Ceramic (Al ₂ O ₃)
(6) Metallized Pad: Mo Ni Plating Au Plating
(2) LID: Fe- Ni -Co
(3) Crystal Enclosure Seal: Seal Seam
(4) Crystal Blank Rectangular At-Cut Quartz Crystal Blank
(5) Adhesive Silver Conductive Silicon Resin
(7) Electrode
(8) Cover Ring : Fe-Ni-Co Alloy

The use prohibition chemistry substance of Table 1 of DHE-0204-1 (HE-QA-24) is not included in this item.

Title HSX211S QUARTZ CRYSTAL SPECIFICATION				Country of origin TAIWAN FACTORY THAILAND FACTORY CHINA FACTORY		
Date	Confirm	Check	Prepare	Spec. No.	Rev.	Page
2016/05/04	F. S. TSAI	Y. W. LEE	U. F. CHEN	X2C024000B71H-V	0	5

4. HSX211S EMBOSS CARRIER TAPE & REEL

a.) Dimensions of Carrier Tape

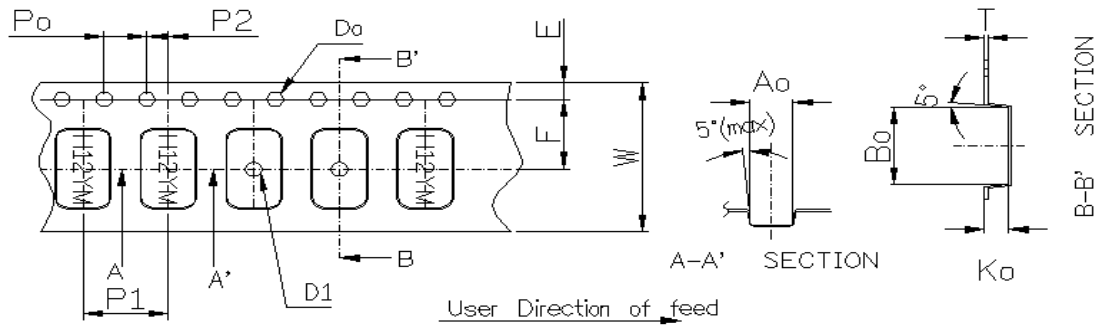

Symbol	Ao	Bo	Ko	Po	P1	P2
Spec	1.9±0.10	2.3±0.10	0.65±0.10	4.0±0.1	4.0±0.1	2.0±0.05
Symbol	E	F	Do	D1	W	T
Spec	1.75±0.1	3.5±0.05	∅1.55±0.05	∅1.1±0.05	8.0±0.2	0.25±0.02

b.) Dimensions of Reel

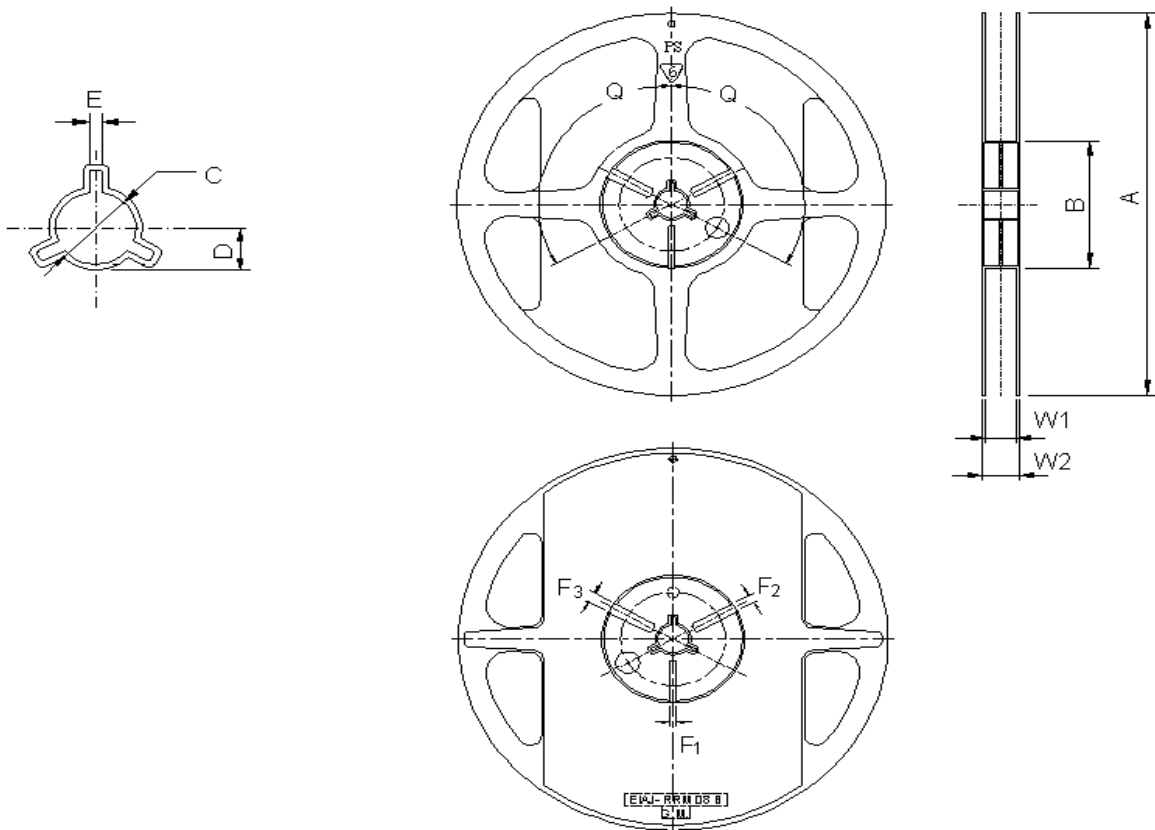

Title **HSX211S**
QUARTZ CRYSTAL SPECIFICATION

Country of origin **TAIWAN FACTORY**
THAILAND FACTORY
CHINA FACTORY

Date	Confirm	Check	Prepare	Spec. No.	Rev.	Page
2016/05/04	F. S. TSAI	Y. W. LEE	U. F. CHEN	X2C024000B71H-V	0	6

(Table-2)

(UNIT: mm)

ITEM		MARK	DIMENSIONS • ANGLE	
FLANCE	Diameter	A	$\psi 180+0/-3$	
	Inner Width	W1	$9.3+/-0.3$	
	Outer Width	W2	$11.3+/-1.0$	
HUB	Out Line diameter	B	$\psi 60.5+/-0.5$	
	Center Core slit	Width	F1	$3.0+0.5/-0$
			F2	$4.0+0.5/-0$
			F3	$5.0+0.5/-0$
		Position	Q	120deg
	Spindle diameter		C	$\psi 13.2+/-0.5$
Key Ditch	Width	E	$3.0+/-0.2$	

c.) Storage condition

Temperature: +40deg.C Max.

Relative Humidity: 80% Max.



d.) Standard packing quantity

3,000PCS / REEL

e.) Material of the tape

Tape	Material
Carrier tape	PS Conductive
Top tape	Polyester

f.) Label contents

	
TYPE:	
SPEC.No.:	
Parts No.:	
Lot No.:	
FREQ.:	MHz
Q'TY:	PCS
HARMONY ELECTRONICS CORP.  HSF	

Sticks label for every reel.

Title HSX211S QUARTZ CRYSTAL SPECIFICATION				Country of origin TAIWAN FACTORY THAILAND FACTORY CHINA FACTORY		
Date	Confirm	Check	Prepare	Spec. No.	Rev.	Page
2016/05/04	F. S. TSAI	Y. W. LEE	U. F. CHEN	X2C024000B71H-V	0	7

g.) Taping dimension

Leader	Cover-tape	The length of cover-tape in the leader is more than 400 mm including empty embossed area.
	Carrier-tape	After all products were packaged, must remain more than twenty pieces or 400 mm empty area, which should be sealed by cover-tape.
Terminal	Cover-tape	The tip of cover-tape shall be fixed temporary by paper tape and roll around the core of reel one round.
	Carrier-tape	The empty embossed area which are sealed by top cover-tape must remain more the 40 mm.



h.) Joint of tape

The carrier-tape and top cover-tape should not be jointed.

i.) Release strength of cover tape

It has to between 0.1N to 0.7N under following condition.

Pulling direction 165° to 180°

Speed 300mm/min.

Otherwise unless specified.

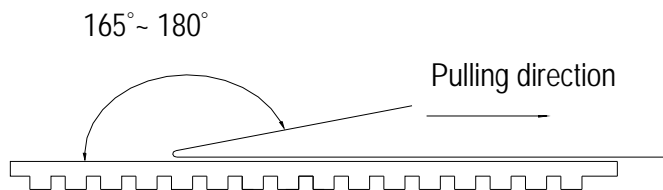

Other standards shall be based on JIS C 0806-1990.

Title HSX211S QUARTZ CRYSTAL SPECIFICATION				Country of origin TAIWAN FACTORY THAILAND FACTORY CHINA FACTORY		
Date	Confirm	Check	Prepare	Spec. No.	Rev.	Page
2016/05/04	F. S. TSAI	Y. W. LEE	U. F. CHEN	X2C024000B71H-V	0	8

j.) Package

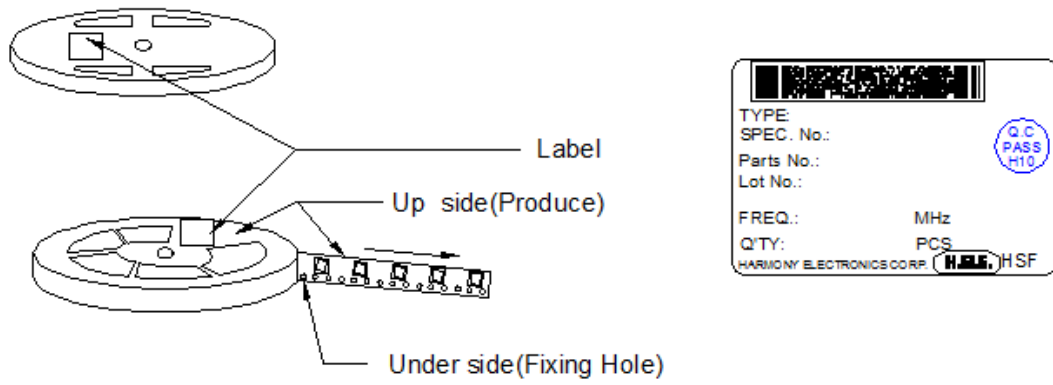

One reel quantity: [1000pcs]&[3000pcs]

- ① Top and bottom with 2.3cm thickness foam-rubber cushion for protection.
- ② Carton's QTY: 1~15 pcs.
- ③ Carton Type=A,B,C use 4 trigon pillar to fasten the Reel.
- ④ Need to add 3 pages dry agent in each outer box.

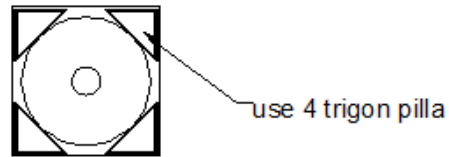

Green Product

ROHS Compliant

Carton Type	A	B	C	D
Produce Type	840/751	630/531/ 421	321/221/ 211/111	OTHER
Reel	15	15	15	1~7
L±3	200	200	200	195
W±3	200	200	200	195
H±3	230/260	230	230	150

1. Every Carton with 3 desiccant.
2. Top and bottom with 2.3cm thickness foam-rubber cushion for protection

Title HSX211S QUARTZ CRYSTAL SPECIFICATION				Country of origin TAIWAN FACTORY THAILAND FACTORY CHINA FACTORY		
Date	Confirm	Check	Prepare	Spec. No.	Rev.	Page
2016/05/04	F. S. TSAI	Y. W. LEE	U. F. CHEN	X2C024000B71H-V	0	9

5. Mechanical Performance

Item		Test Methods	Specifications Code
1	Natural Drop	Dropping from 120 cm height 3 times on Concrete floor Refer to: JIS C 60068-2-6	A
2	Vibration	Frequency 10-55Hz, Sine Wave full amplitude of 0.8mm to X, Y and Z 3 axes, Duration of 2 hours to each axis. Refer to: MIL-HDBK-781A 6.5.2/ JIS C 60068-2-6	A
3	Sealing Tightness	Leak Rate 1.0×10^{-8} Pa-m ³ /sec. Max. Measured by Helium leak detector.	---
4	Solder ability	After applying ROSIN Flux, dipping in solder bath at 245deg.C +/- 5deg.C for 3 +/- 0.5 sec. Refer to: JIS C 60068-2-20	B
5	Substrate Bending	Mount a sample on board. Apply Pressure to the center of board until it is bent to 3 mm and hold for 5 ± 1 sec Pressure speed : 0.5 mm / sec Refer to: EIAJ ET-7403	A
6	Adhesion	Mount a sample on the circuit board. Apply pressure vertically to the side of specimen attached to the circuit board with the pressure jig. Pressure : 5N for 10 ± 1 sec Refer to: EIAJ ET-7403	A
7	Body strength	Apply pressure to the center of body with the R0.5 pressure jig. pressure : 10N for 10 ± 1 sec Refer to: EIAJ ET-7403	A

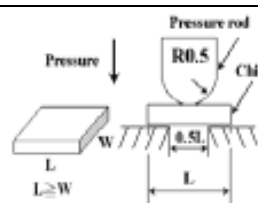
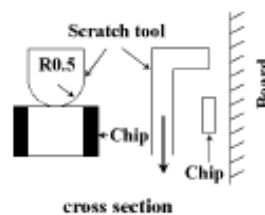
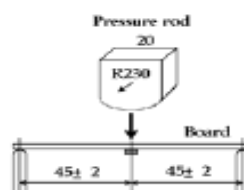

Title **HSX211S**
QUARTZ CRYSTAL SPECIFICATION

Country of origin **TAIWAN FACTORY**
THAILAND FACTORY
CHINA FACTORY

Date	Confirm	Check	Prepare	Spec. No.	Rev.	Page
2016/05/04	F. S. TSAI	Y. W. LEE	U. F. CHEN	X2C024000B71H-V	0	10

6. Environment Performance

Item		Test Methods	Specifications Code
1	Humidity	Temperature 60°C +/-2°C, RH 90~95%, Duration of 240 hours. Back to room temperature first, then in 1~2 hours, the component shall be checked. Refer to: JIS C 60068-2-3	A
2	Storage in Low Temperature	-40deg.C +/-2deg.C, Duration of 240 hours. Back to the room temperature first, then in 1~2 hours, the component shall be checked. Refer to: JIS C 60068-2-1	A
3	Storage in High Temperature	+85deg.C +/-2deg.C, Duration of 240 hours. Back to the room temperature first, then in 1~2 hours, the component shall be checked. Refer to: JIS C 60068-2-2	A
4	Temperature cycles	-40deg.C +/-2deg.C (30min) ↔ +85deg.C +/-2deg.C (30min) 25 cycles. Back to the room temperature first, then in 1~2 hours, the component shall be checked. Refer to: JIS C 0025	A

Specifications code	Specifications
A	Frequency variation shall be within +/-5ppm and equivalent resistance shall be within +/-15% or 2Ω
B	More than 90% of lead shall be covered by new solder.

Title HSX211S QUARTZ CRYSTAL SPECIFICATION				Country of origin TAIWAN FACTORY THAILAND FACTORY CHINA FACTORY		
Date	Confirm	Check	Prepare	Spec. No.	Rev.	Page
2016/05/04	F. S. TSAI	Y. W. LEE	U. F. CHEN	X2C024000B71H-V	0	11

7. Supplement

7.1.Soldering

7.2.Please stay with our proposed reflow condition and do then soldering 2 times max.

Available for Lead Free Soldering

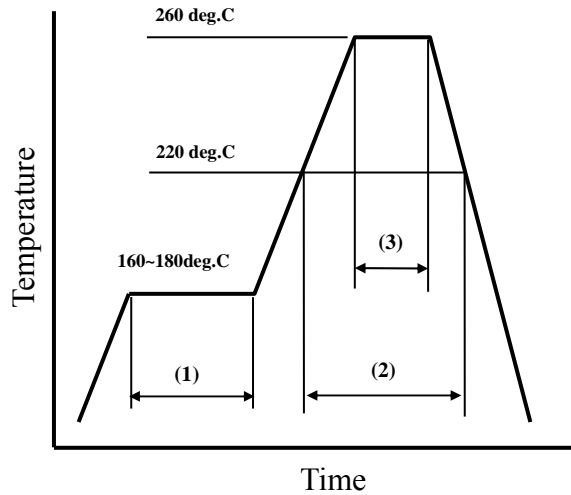

(1)	Preheat	160~180 deg.C	120sec.
(2)	Primary heat	220 deg.C	60sec.
(3)	Peak	260 deg.C	10sec. Max.

7.3.Land pattern layout(Example)

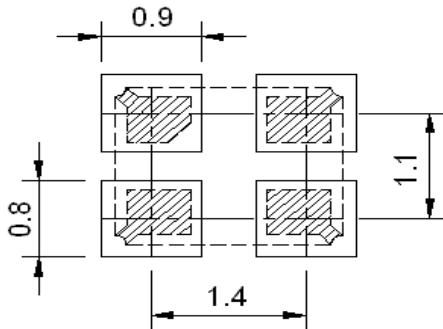

7.4.Solder iron (Example)

Bit temp.: 350°C max., Time: 3sec max. , Each terminal solder a 1 time max.

Title HSX211S QUARTZ CRYSTAL SPECIFICATION				Country of origin TAIWAN FACTORY THAILAND FACTORY CHINA FACTORY		
Date	Confirm	Check	Prepare	Spec. No.	Rev.	Page
2016/05/04	F. S. TSAI	Y. W. LEE	U. F. CHEN	X2C024000B71H-V	0	12

7.5.Mounting

This component is designed for automatic insertion.

However, you are requested to do the trial with your insertion machine in order to be sure

Of proper operation and no damage of component.

Please pay attention to board warp which may damage the component and cause

Soldering process.

Avoid mounting and processing by Ultrasonic welding because this method has a possibility

Of an excessive vibration spreading inside the crystal products and becoming the cause of

Characteristic deterioration and not oscillating.

7.6.Cleaning

Cleaning liquid which corrodes Nickel shall not be used

It may cause the problem on the surface, color, marking etc.

Ultra-sonic cleaning is possible, however, you are requested to check on your board.

Because we only checked as single unit.

7.7.Storage

Please keep away from high temperature and high humidity, which may cause put solderbility.

No direct Sunlight, No dew as well.

Title HSX211S QUARTZ CRYSTAL SPECIFICATION				Country of origin TAIWAN FACTORY THAILAND FACTORY CHINA FACTORY		
Date	Confirm	Check	Prepare	Spec. No.	Rev.	Page
2016/05/04	F. S. TSAI	Y. W. LEE	U. F. CHEN	X2C024000B71H-V	0	13

8. Flow Chart

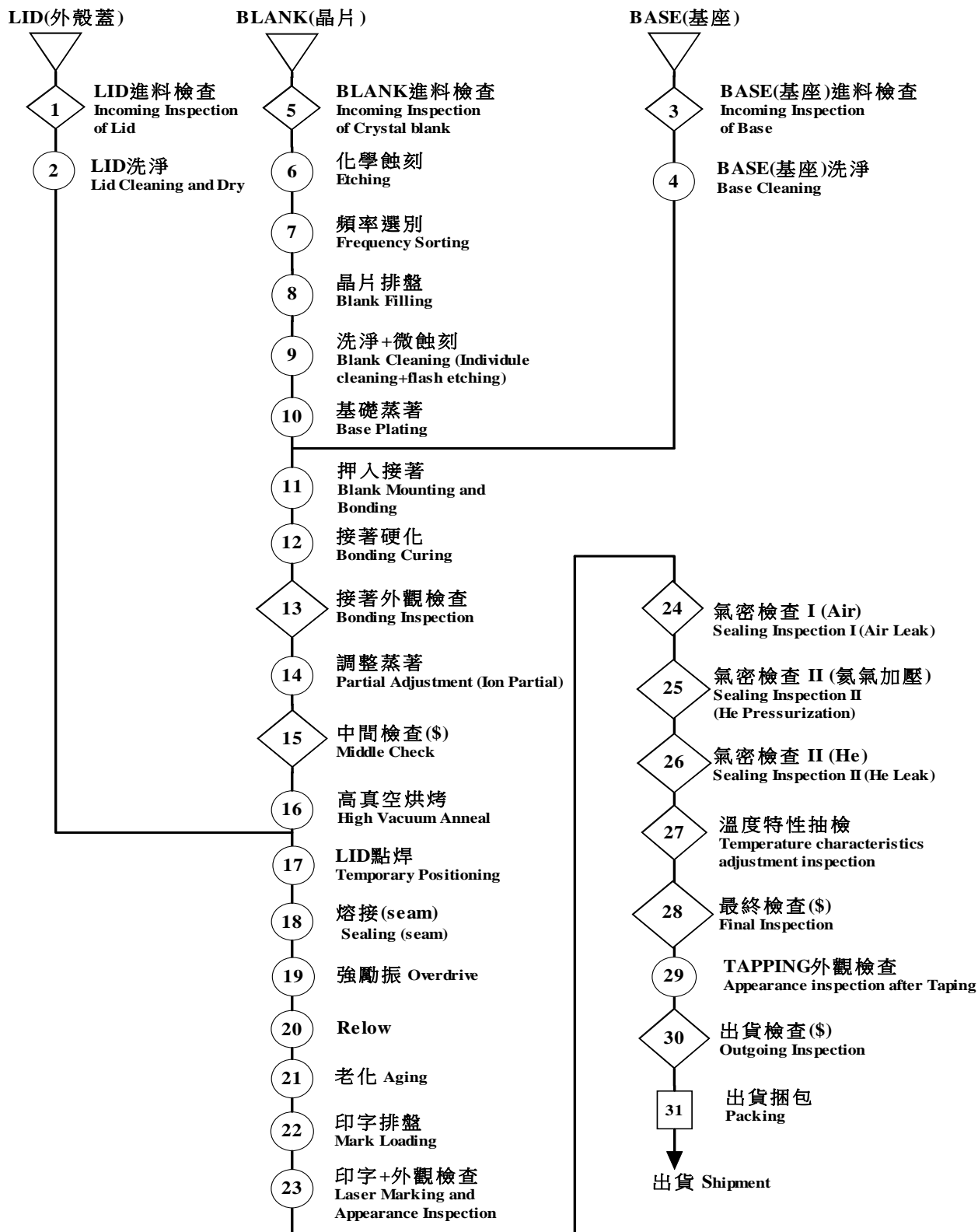

(\$): 特殊特性
(For Critical process had been monitored)

Title HSX211S QUARTZ CRYSTAL SPECIFICATION				Country of origin TAIWAN FACTORY THAILAND FACTORY CHINA FACTORY		
Date	Confirm	Check	Prepare	Spec. No.	Rev.	Page
2016/05/04	F. S. TSAI	Y. W. LEE	U. F. CHEN	X2C024000B71H-V	0	14

X-ON Electronics

Largest Supplier of Electrical and Electronic Components

Click to view similar products for [Crystals](#) category:

Click to view products by [Harmony](#) manufacturer:

Other Similar products are found below :

[CS325S24000000ABJT](#) [718-13.2-1](#) [MC405 32.0000K-R3:PURE SN](#) [FC-135R 32.7680KF-A3](#) [7A-40.000MAAE-T](#) [7B-27.000MBBK-T](#)
[FL2000085](#) [9B-15.360MBBK-B](#) [9C-7.680MBBK-T](#) [ASH7K-32.768KHZ](#) [AT-41.600MAGQ-T](#) [BTD1062E05A-513](#) [LFX TAL066198Cutt](#)
[9C-14.31818MBBK-T](#) [FA-238 50.0000MB30X-K3](#) [FC-12M 32.7680KA-AC3](#) [SSPT7F-9PF20-R](#) [FX325BS-38.88EEM1201](#)
[LFX TAL065253Cutt](#) [LFX TAL066431Cutt](#) [XT9S20ANA14M7456](#) [XT9SNLANA16M](#) [646G-24-2](#) [7A-24.576MBBK-T](#) [7B-30.000MBBK-T](#)
[WX26-32.768K-6PF](#) [9B-14.31818MBBK-B](#) [CD1AM](#) [7B-25.000MAAE-T](#) [7A-14.31818MBBK-T](#) [6504-202-1501](#) [6526-202-1501](#) [FA-118T](#)
[27.1200MB50P-K0](#) [FC-135R 32.7680KA-A3](#) [ABM12-104-37.400MHZT](#) [ABLS-10.000MHZ-D3W-T](#) [BTJ112E01E-513](#) [BTJ722K01C-7067](#)
[BTL-20-513](#) [TSX-3225 24.0000MF15X-AC](#) [TSX-3225 16.0000MF18X-AC](#) [BTJ120E02C](#) [BTL-12-513](#) [7A-10.000MBBK-T](#) [7A-](#)
[11.0592MBBK-T](#) [ABM12-103-24.000MHZT](#) [CS325S25000000ABJT](#) [ABM3B-25.000MHZ-B2-X-T](#) [FC-135 32.7680KA-A5](#) [FX0800015](#)