

规格 Specifications

额定负荷 Rating	DC 12V/50mA
接触电阻 Contact Resistance	500mΩ max.
绝缘电阻 Insulation resistance	DC100V 60S 100MΩ min.
抗电强度 Dielectric strength	AC250V(50-60HZ) 60S min.
操作力 Operation force	≤180±30gf ≥240±50gf
寿命试验 Operating Life	300,000 cycles 100,000 cycles
行程 Travels	0.15±0.05mm

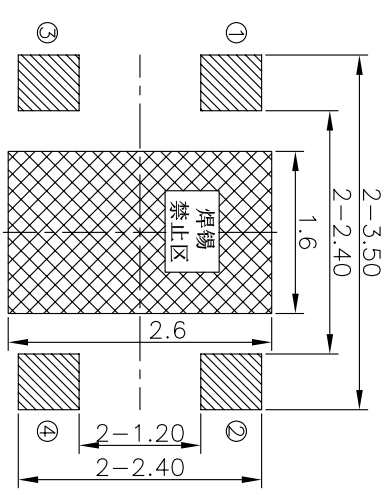
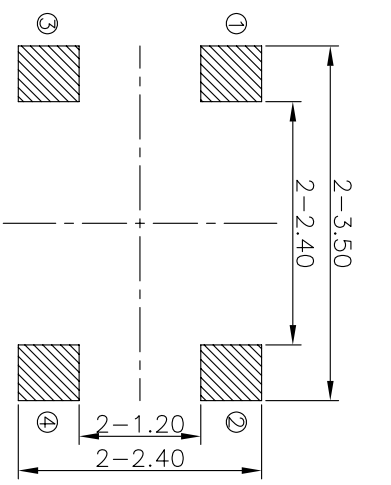
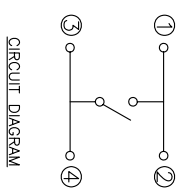
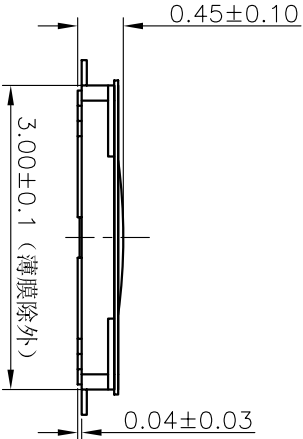

PRODUCT NO. : 1TS016B***-0450 - **

轻触开关
3X2.6系列
外形:
A=四脚
B=四脚无按柄

按点颜色:
底座颜色:
贴膜颜色:

操作力度:
160=160gf
180=180gf
240=240gf

手感:
0=常规(弹片)
1=大手感(弹片)
2=小手感(弹片)
3=特殊手感(弹片)

脚距:
0=常规脚距3.5mm
1=特殊脚距3.2mm
依次增加

产品高度(H):
045=0.45mm

其它:
CT=编带(非编带,不启用)

ITEM	PART NAME	QUANTITY	MATERIAL	FINISH
4	FILM	1	POLYAMIDE	WHITE
3	DOME	2	STAINLESS STEEL	Ag-PLATED
2	HOUSING	1	POLYAMIDE	BLACK
1	TERMINAL	1	PHOSPHOR BRONZE	Ag-PLATED

X. ± 0.2	X' ± 3'	UNITS	MM
.X ± 0.1	.X' ± 2'	MATL	
.XX ± 0.05	.XX' ± 1'	FINISH	
.XXX ± 0.03	.XXX' ± 0.5'		

NAME(INTENDED USE)	HON YUAN
3X2.6 SERIES	HON YUAN PRECISION IND. CO.,LTD.
TACT SWITCHES	SHENZHEN, CHINA.
PART NO.(INTENDED USE)	1TS016B***-0450
APPD:	ZO 3/13/2019
CHKD:	M.H.LI 3/13/2019
DR:	Y.Y.Chen 3/13/2019
DWG NO.:	1TS016B
SCALE	1/1
SHEET	1/1
REV.	A

THESE DRAWINGS AND SPECIFICATIONS ARE THE PROPERTY OF HON YUAN PRECISION IND. CO., LTD. AND SHALL NOT BE REPRODUCED, COPIED OR USED IN ANY MANNER WITHOUT THE WRITTEN PERMISSION OF HON YUAN PRECISION IND. CO., LTD.

X-ON Electronics

Largest Supplier of Electrical and Electronic Components

Click to view similar products for [Tactile Switches](#) category:

Click to view products by [HYP](#) manufacturer:

Other Similar products are found below :

[KMR633NG LFG](#) [5GTH92001](#) [5GTH9202242](#) [6426-201-11343](#) [MJ1226](#) [MJTP1109B](#) [MJTP1138EAUTR](#) [MJTP1230BL](#) [MJTPSHW](#)
[GS6.90F300QP](#) [1-1977223-0](#) [1-1977120-4](#) [ADTSA62NV](#) [ADTSA62RV](#) [ADTSA63KV](#) [ADTSA644NV](#) [ADTSM24NVTR](#) [ADTSMW66NV](#)
[ADTSMW67RV](#) [ATM533VTR](#) [1571300-3](#) [B3F-3123](#) [B3F-6055A](#) [B3F-B32-01-KIT](#) [1977177-8](#) [1977266-1](#) [2-1977223-4](#) [2-1977223-7](#)
[ADTS644KV](#) [ADTSA61RV](#) [ADTSA62KV](#) [ADTSA63NV](#) [ADTSA63RV](#) [ADTSA65NV](#) [ADTSM21NSVTR](#) [ADTSM25RVTR](#)
[ADTSM31RVTR](#) [ADTSM32NVTR](#) [ADTSM61YVTR](#) [ADTSM63SVTR](#) [ADTSM644KVTR](#) [ADTSMW64RV](#) [ADTSMW69NV](#)
[FSMRA4JHA04](#) [GS4.70F300QP](#) [D38999/20JJ37SA](#) [TL1105B](#) [TL1105J](#) [ATH447K2Q](#) [ATM534VTR](#)