



## SPECIFICATION OF PRODUCT 承认书

CUSTOMER: \_\_\_\_\_

DESCRIPTION: Magnetic Buzzer

FUSHENG P/N: FST-9650B-3v

CUSTOMER P/N: \_\_\_\_\_

DATE: 2018-8-28

CUSTOMER	APPROVER	CHECKER
	Yunqing Wu	Bing Yan

### 泰州福声电子科技有限公司

地址:江苏省泰州市海陵区凤凰西路 168 号

电话: 0086-523-86219066 传真: 0086-523-81601108

邮箱: sales@electronic-tech.cn

网址: [www.tzfsdz.com](http://www.tzfsdz.com)

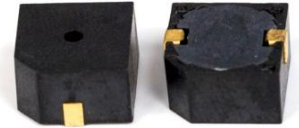

## 1.SPECIFICATION 规格

No.	Item	Unit	Specification	Condition
1	Oscillation Frequency	Hz	3000	
2	Operating Voltage	VDC	2 ~ 5	
3	Rated Voltage	VDC	3	
4	Current Consumption	mA	MAX. 30	at Rated Voltage
5	Sound Pressure Level	dB	MIN. 85	at 10cm at Rated Voltage
6	Operating Temperature	°C	-20 ~ +80	
7	Storage Temperature	°C	-30 ~ +85	
8	Dimension	mm	9.6x 9.6x H 5.0	See appearance drawing
9	Weight (MAX)	gram	2	
10	Housing Material		PPS( Black )	
11	Leading Pin		Tin Plated Brass(Au)	See appearance drawing
12	Environmental Protection Regulation		RoHS	

## 2. APPEARANCE DRAWING 尺寸图

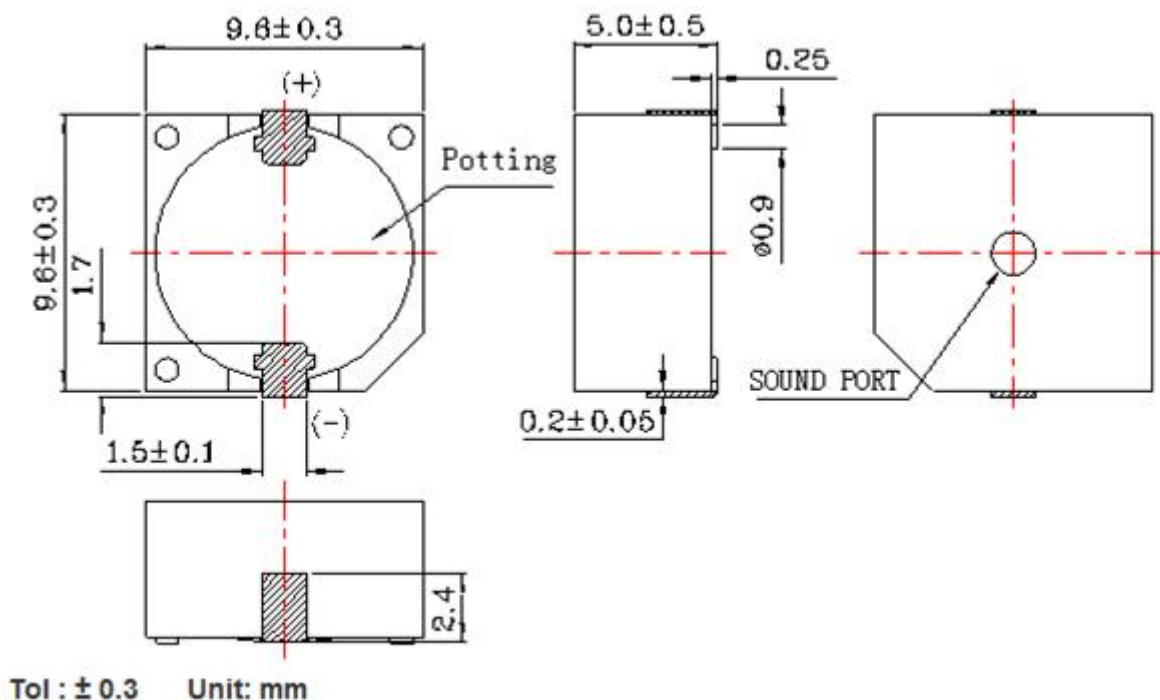

### 3. TESTING METHOD 测量方式

#### Standard Measurement conditions

Temperature:  $25 \pm 2^\circ\text{C}$  Humidity: 45-65%

#### Acoustic Characteristics:

The oscillation frequency, current consumption and sound pressure are measured by the measuring instruments shown below

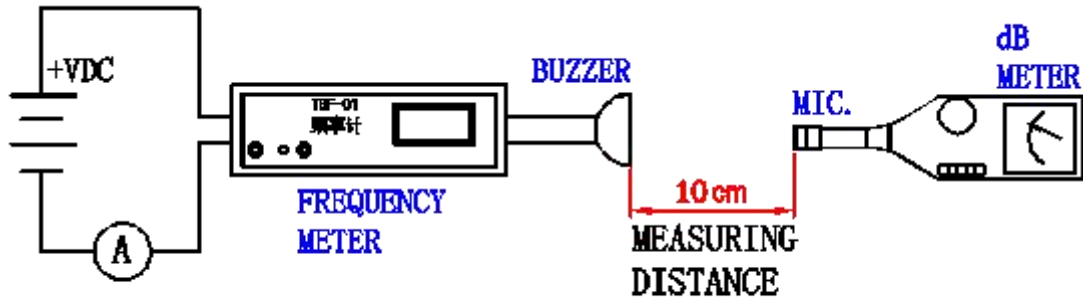

In the measuring test, buzzer is placed as follows:

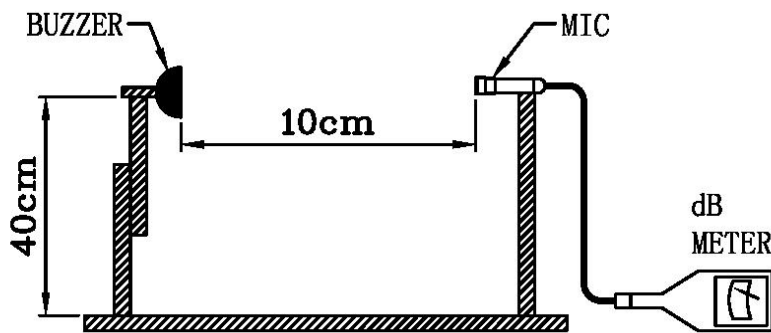

### 4. VOLTAGE / CURRENT / SOUND PRESSURE CHARACTERISTICS

dB-V

mA-V

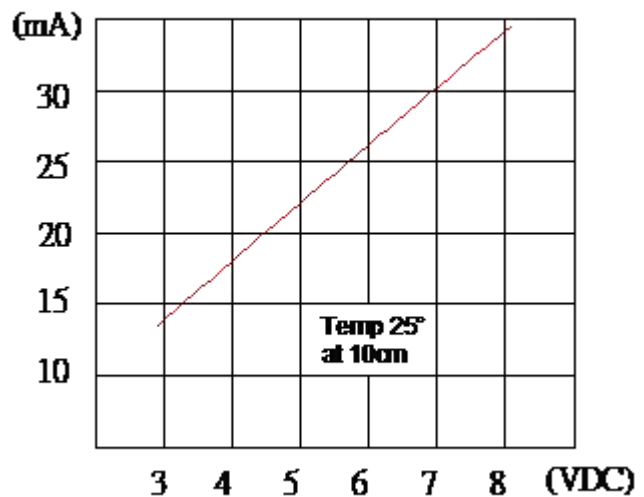
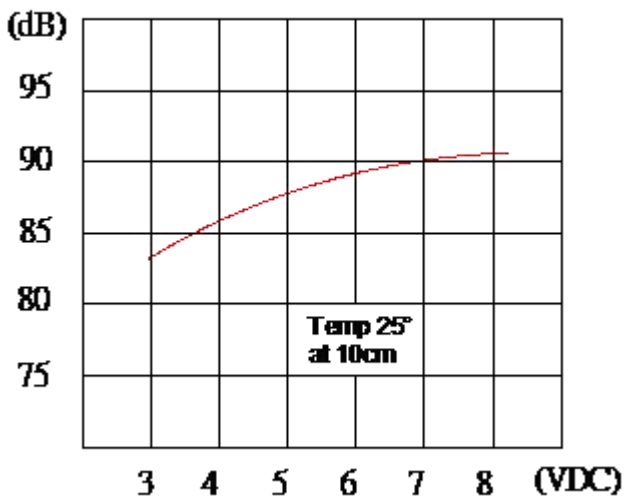

## 5.Soldering Condition

(1)Recommendable reflow soldering condition is as follows

(Reflow soldering is twice)

Note:It is requested that reflow soldering should be executed after heat of product goes down to normal.

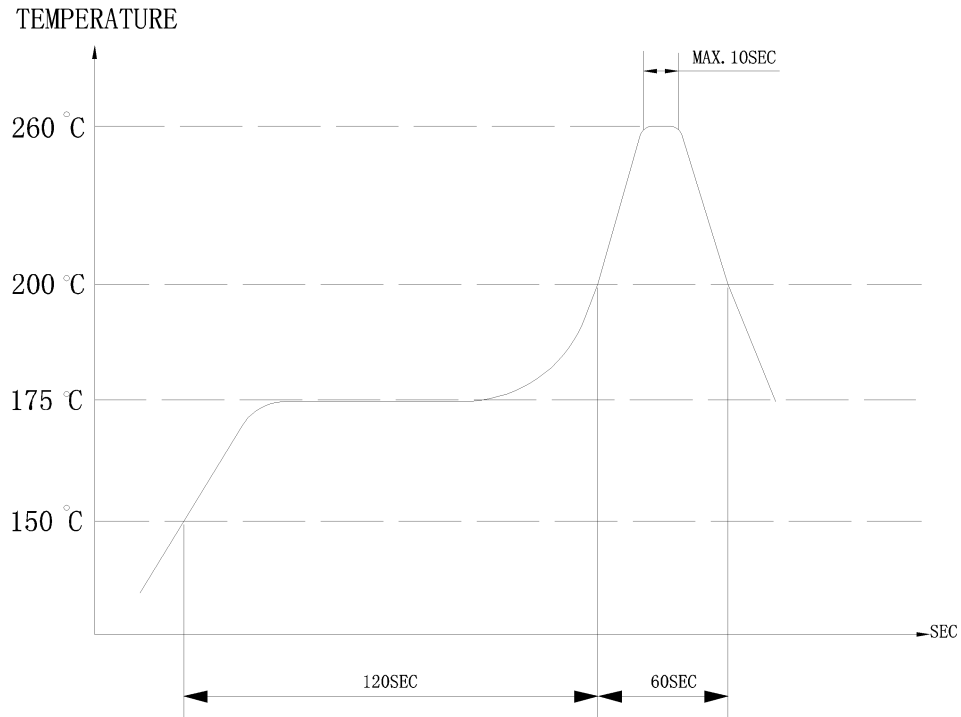

Heat resistant line

(Used when heat resistant reliability test is performed)

(2)Manual soldering

Manual soldering temperature 350 °C within 5 sec.

## 6. RELIABILITY TEST 可靠性测试

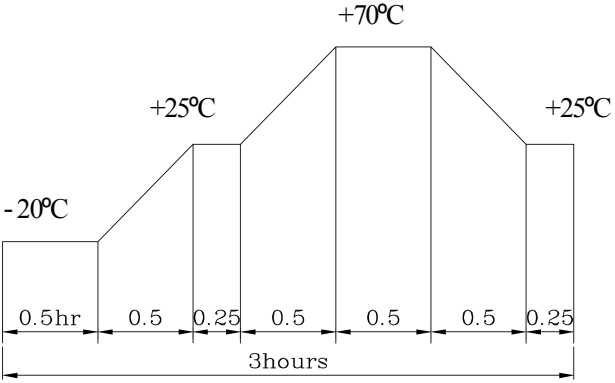
NO.	ITEM	TEST CONDITION AND REQUIREMENT
1	High Temperature Test (Storage)	After being placed in a chamber with 80 °C for 96 hours and then being placed in normal condition for 2 hours. Allowable variation of SPL after test: 10dB.
2	Low Temperature Test (Storage)	After being Placed in a chamber with -30 °C for 96 hours and then being placed in normal condition for 2 hours. Allowable variation of SPL after test: 10dB.
3	Humidity Test	After being Placed in a chamber with 90-95% R.H. at 40 °C for 96 hours and then being placed in normal condition for 2 hours. Allowable variation of SPL after test: 10dB.
4	Temperature Cycle Test	The part shall be subjected to 5 cycles. One cycle shall be consist of:  <p>The diagram shows a temperature cycle profile over 3 hours. It starts at -20°C for 0.5 hours, then ramps up to +25°C in 0.5 hours, holds at +25°C for 0.25 hours, ramps up to +70°C in 0.5 hours, holds at +70°C for 0.5 hours, ramps down to +25°C in 0.5 hours, holds at +25°C for 0.25 hours, and finally ramps down to -20°C in 0.5 hours. The total duration is 3 hours.</p> Allowable variation of SPL after test: 10dB.
5	Drop Test	Drop on a hard wood board of 4cm thick, any directions ,6 times, at the height of 75cm . Allowable variation of SPL after test: 10dB.
6	Vibration Test	After being applied vibration of amplitude of 1.5mm with 10 to 55 Hz band of vibration frequency to each of 3 perpendicular directions for 2 hours . Allowable variation of SPL after test: 10dB.
7	Solderability Test	Lead terminals are immersed in rosin for 5 seconds and then immersed in solder bath of +300 °C for 3 1 seconds . 90% min. lead terminals shall be wet with solder (Except the edge of terminals).
8	Terminal Strength Pulling Test	The force of 9.8N(1.0kg) is applied to each terminal in axial direction for 10 seconds. No visible damage and cutting off.

### TEST CONDITION.

Standard Test Condition	:	a) Temperature : +5 ~ +35°C	b) Humidity : 45-85%	c) Pressure : 860-1060mbar
一般测试条件	:	a) 温度 : +5 ~ +35°C	b) 湿度 : 45-85%	c) 气压 : 860-1060mbar
Judgment Test Condition	:	a) Temperature : +25 ± 2°C	b) Humidity : 60-70%	c) Pressure : 860-1060mbar
争议时测试条件	:	a) 温度 : +25 ± 2°C	b) 湿度 : 60-70%	c) 气压 : 860-1060mbar

## 7. PACKING STANDARD 包装

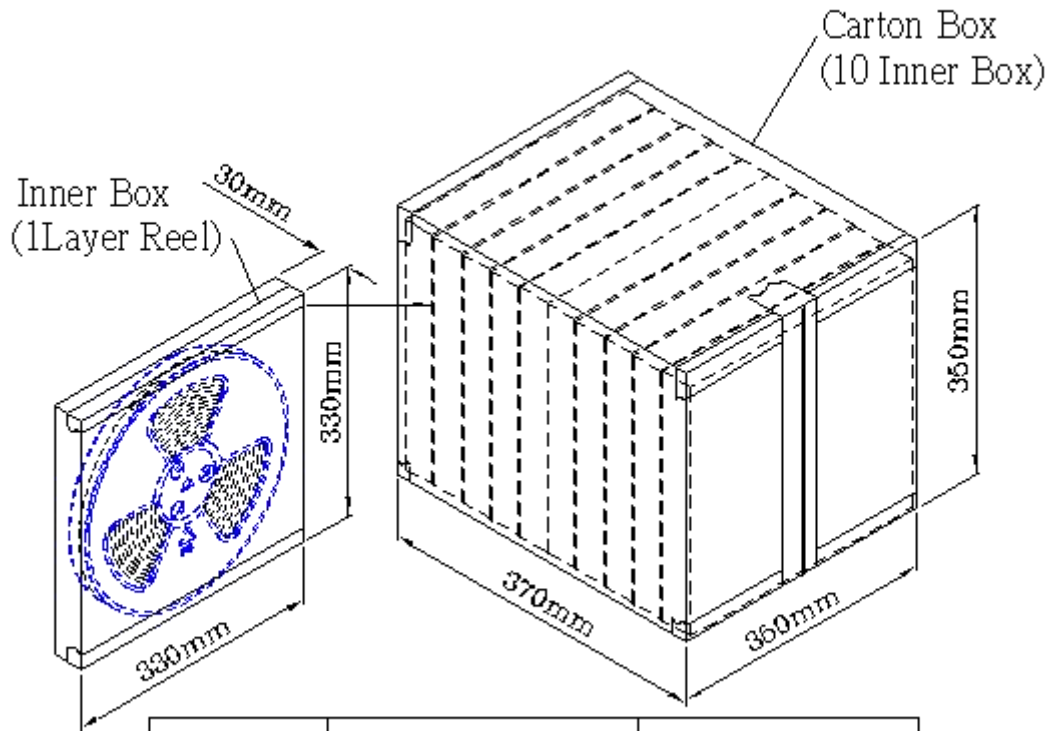
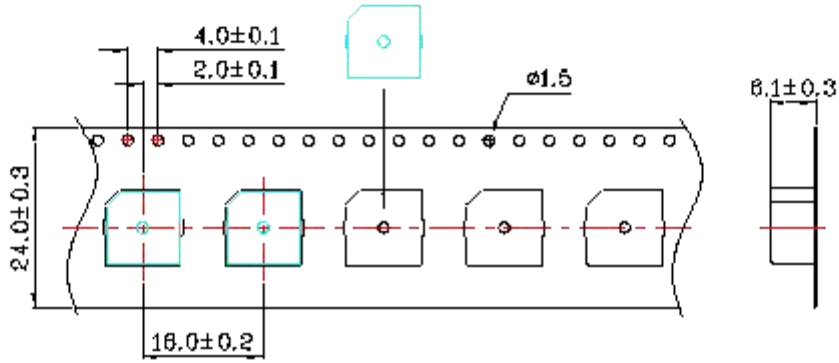
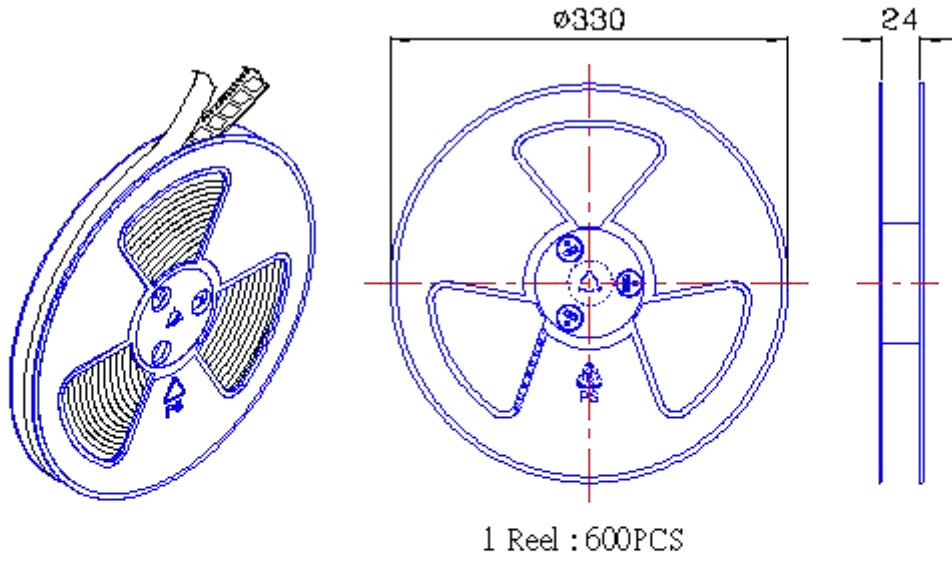

Inner Box	330mm×330mm×30mm	1×600PCS=600PCS
Carton Box	350mm×350mm×370mm	10×600PCS=6,000PCS

## X-ON Electronics

Largest Supplier of Electrical and Electronic Components

*Click to view similar products for [Audio Indicators & Alerts](#) category:*

*Click to view products by [FUET](#) manufacturer:*

Other Similar products are found below :

[M2BJ-BH24E](#) [6-4](#) [68S1240-PA](#) [MBA-624](#) [F/BC 40P-DR LF](#) [FDG111PLF](#) [F/NRMB 24 BLACK LF](#) [PF-35N29WQ](#) [PFD-27A35PQ](#) [PL-27A35PSQ](#) [PS-531Q](#) [AB2020B-2-LW1](#) [EBPT-401](#) [PB06SD12AP](#) [PB-1220PEQ](#) [S6109](#) [SC2036ACP](#) [SC616N-2](#) [SC628FW](#) [SC628MPG](#) [SC648D](#) [SCS045MD9DT3S](#) [AB2025B-LW50-R](#) [ESZ-25B-5-250B](#) [F/BC 35-DR LF](#) [FCM12PLF](#) [F/EB20P-DR LF](#) [F/HU110MP24V-IP67B LF](#) [AI-2835-TF-LW150-2-R](#) [AI-4228-TF-LW305-R](#) [FSMD8585JSLF](#) [FSS-26T](#) [F/SU 21-02 LF](#) [F/TCW 05 WITH LABEL LF](#) [F/UCW 03 WITH LABEL LF](#) [F/UCW 06 WITH LABEL LF](#) [PKM22EPPH40S1-B0](#) [PKM35-4A0](#) [PL-35N29WQ](#) [PLD-27A35PQ](#) [PS-552Q](#) [CM-5](#) [M2BJ-BH24E-D](#) [REF-202](#) [LSC628ANR](#) [5-100](#) [PAL-328](#) [03-810.001](#) [RTO-1R07-001](#) [PL-21N31PQ](#) [PF-27A25PSQ](#)