

# BL 0605 Series

## Multilayer Chip Baluns

### Features

- ❖ Monolithic SMD with small, low-profile and light-weight type.
- ❖ RoHS compliant

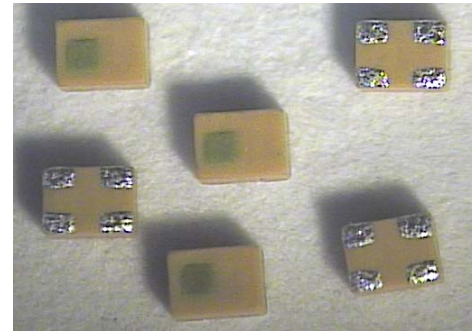

### Applications

- ❖ 758 ~ 821 MHz wireless communication systems.

### Specifications

Part Number	Frequency Range (MHz)	Unbalanced Impedance (ohm)	Balance Impedance (ohm)	Insertion Loss (dB)	VSWR @BW	Phase Difference (degree)	Amplitude Difference (dB)
<b>BL0605-10L0790NA_</b>	758~821	50	100	0.8 max.	2.0 max.	180 ± 10	2.0 max.

Q'ty/Reel (pcs) : 10,000  
 Operating Temperature Range : -40 ~ +85 °C  
 Storage Temperature Range : -40 ~ +85 °C  
 Storage Period : 12 months max.\*  
 \*12 months in vacuum sealed bag and 1 week after opened. Please keep unused parts in vacuum sealed bags.  
 Solder Paste : SAC 305 type is recommended.  
 Power Capacity : 2W max.

### Part Number

BL   0605   -   10   L   0790   NA   □   /LF  
 ①   ②   ③   ④   ⑤   ⑥   ⑦   ⑧

① Type	BL : Balun	② Dimensions ( L x W )	0.6 x 0.5 mm
③ Balanced Impedance	10 : 100 ohm	④ Material Code	L
⑤ Central Frequency	0790 : 790MHz	⑥ Specification Code I	NA
⑦ Packaging	T: Tape & Reel B: Bulk	⑧ Soldering	/LF=lead-free

### Terminal Configuration

< Top View >

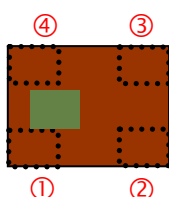

No.	Terminal Name	No.	Terminal Name
①	GND	③	Balanced Port
②	Unbalanced Port	④	Balanced Port

## Dimensions and Recommended PC Board Pattern

Unit : mm

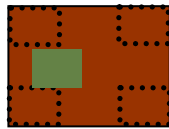

< Top View >

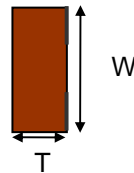

< Side View >

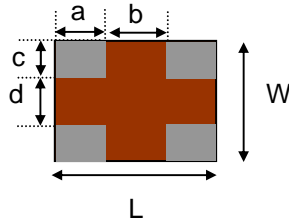



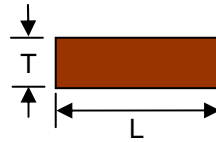

< Bottom View >

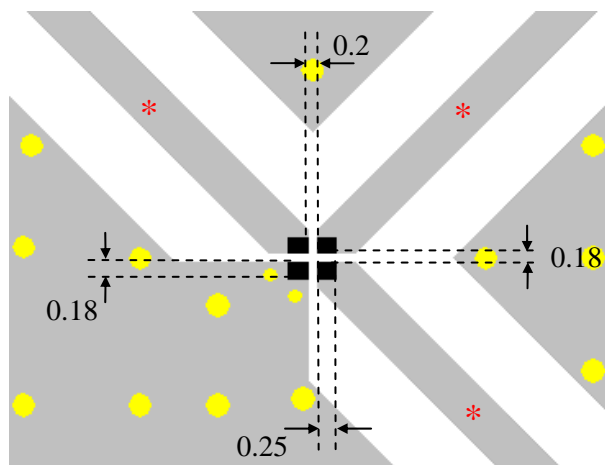

< Side View >

Mark	L	W	T	a	b	c	d
<b>Dimensions</b>	0.65 ± 0.05	0.5 ± 0.05	0.45 max	0.225 +0.1/-0.05	0.2 +0.1/-0.05	0.15 +0.1/-0.05	0.2 +0.1/-0.05



-  Solder Resist
-  Land
-  Through-hole ( $\phi$  0.2 / 0.35)

\* Line width should be designed to match 50 $\Omega$  characteristic impedance, depending on PCB material and thickness.

## Measuring Diagram

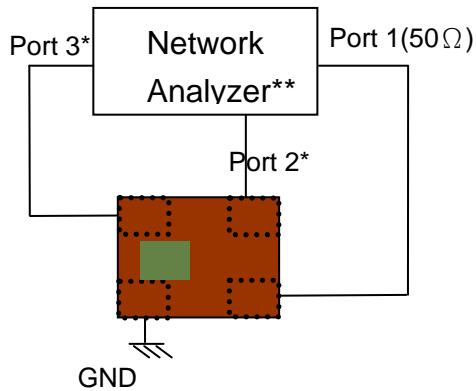

Port 1: Unbalanced Port

Ports 2 and 3: Balanced Port

$$IL = S_{ds21}$$

$$RL = S_{ss11}$$

$$\text{Amp\_balance} = \text{dB}(S(2,1)/S(3,1))$$

$$\text{Phase\_balance} = \text{Phase}(S(2,1)/S(3,1))$$

\*Impedance for ports 2 and 3 = Balanced Impedance/2

\*\*E5071B from Agilent

## Typical Electrical Characteristics (T=25°C)

### Insertion and Return Loss

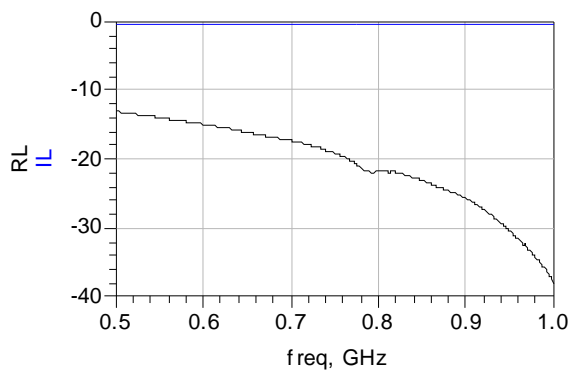

### Amplitude and Phase Balance

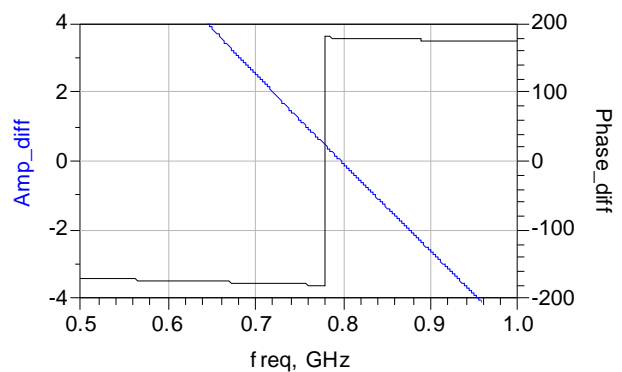

## Notes

❖ The contents of this data sheet are subject to change without notice. Please confirm the specifications and delivery conditions when placing your order.

## Taping Specifications

### ❖ Tape Dimensions (Unit: mm) & Quantity

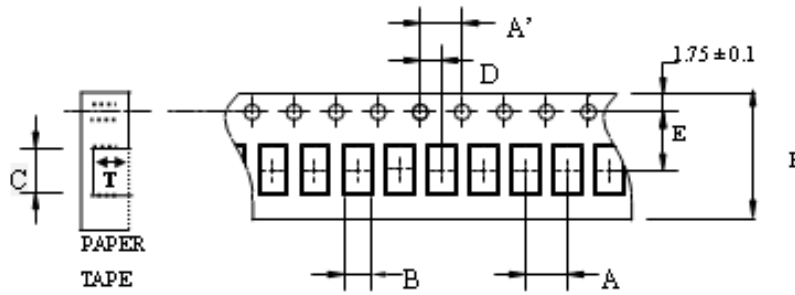

Type	A	A'	B	C	D	E	F	T	Quantity/reel	Tape material
0605	2.0±	4.0±	0.58±	0.78±	2.0±	3.5±	8.0±	0.45±	10,000pcs	Paper
	0.05	0.1	0.03	0.03	0.05	0.05	0.2	0.03		

### ❖ Reel Dimensions (Unit: mm)

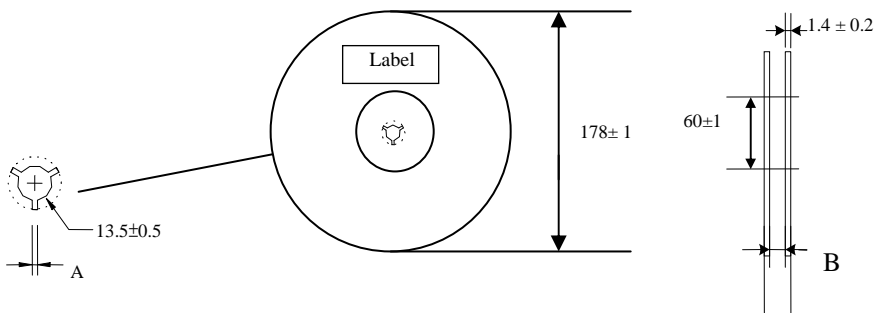

Label: Customer's Name,  
ACX P/N, Q'ty, Date,  
ACX Corp.

Type	A	B
0605	2.3±0.5	9.0±0.3

### ❖ Leader and Trailer Tape

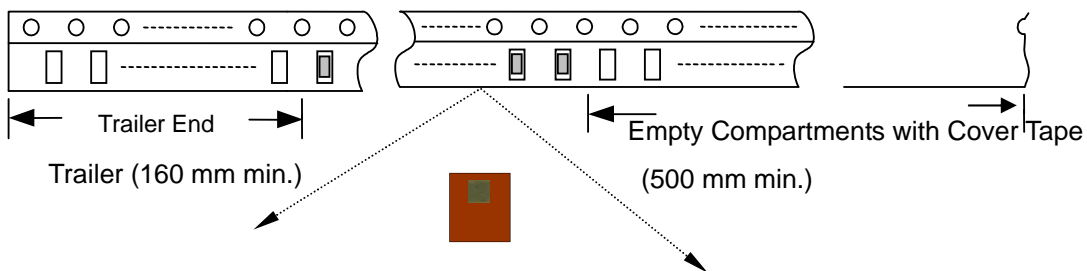

❖ **Peel-off Force**

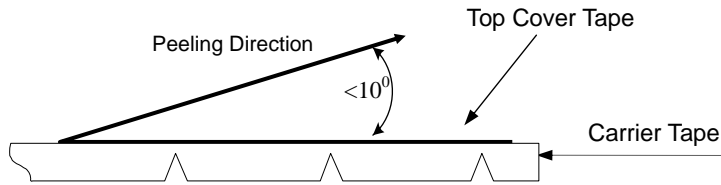

Peel-off force should be in the range of 0.1 – 0.6 N at a peel-off speed of  $300 \pm 10$  mm/min .

❖ **Storage Conditions**

- (1) Temperature:  $5 \sim 35^{\circ}\text{C}$  , relative humidity (RH): 45~75%.
- (2) Non-corrosive environment.

**Notes**

- ❖ The contents of this data sheet are subject to change without notice. Please confirm the specifications and delivery conditions when placing your order.

## Mechanical & Environmental Characteristics

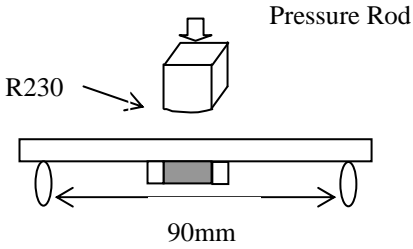
Item	Requirements	Procedure
Solderability	<ol style="list-style-type: none"> <li>No apparent damage</li> <li>More than 75% of the terminal electrode shall be covered with new solder.</li> </ol>	<ol style="list-style-type: none"> <li>Preheat: <math>120 \pm 5^\circ\text{C}</math></li> <li>Solder: <math>245 \pm 5^\circ\text{C}</math> for <math>5 \pm 1</math> sec</li> </ol>
Soldering strength (Termination Adhesion)	<ol style="list-style-type: none"> <li>2N minimum</li> </ol>	<ol style="list-style-type: none"> <li>Solder specimen onto test jig.</li> <li>Apply push force at 0.5mm/s until electrode pads are peeled off or ceramic are broken. Pushing force is applied to longitude direction</li> </ol>
Deflection (Substrate Bending)	<ol style="list-style-type: none"> <li>No apparent damage</li> <li>Fulfill the electrical specification</li> </ol>	<ol style="list-style-type: none"> <li>Solder specimen onto test jig (FR4, 0.8mm) using the recommend soldering profile.</li> <li>Apply a bending force of 2mm deflection</li> </ol> 
Heat/Humidity Resistance	<ol style="list-style-type: none"> <li>No apparent damage</li> <li>Fulfill the electrical specification after test</li> </ol>	<ol style="list-style-type: none"> <li>Temperature: <math>85 \pm 2^\circ\text{C}</math></li> <li>Humidity: 90% ~ 95% RH</li> <li>Duration: <math>1000 \pm 48</math>hrs</li> <li>Recovery: 1-2hrs</li> </ol>
Thermal shock (Temperature Cycle)	<ol style="list-style-type: none"> <li>No apparent damage</li> <li>Fulfill the electrical specification after test</li> </ol>	<ol style="list-style-type: none"> <li>One cycle/step 1 : <math>125 \pm 5^\circ\text{C}</math> for 30 min step 2 : <math>-40 \pm 5^\circ\text{C}</math> for 30 min</li> <li>No of cycles : 100</li> <li>Recovery: 1-2 hrs</li> </ol>
Low Temperature Resistance	<ol style="list-style-type: none"> <li>No apparent damage</li> <li>Fulfill the electrical specification after test</li> </ol>	<ol style="list-style-type: none"> <li>Temperature: <math>-40 \pm 5^\circ\text{C}</math></li> <li>Duration: <math>500 \pm 24</math>hrs</li> <li>Recovery: 1-2hrs</li> </ol>

## Soldering Conditions

### ❖ Typical Soldering Profile for Lead-free Process

Reflow Soldering :

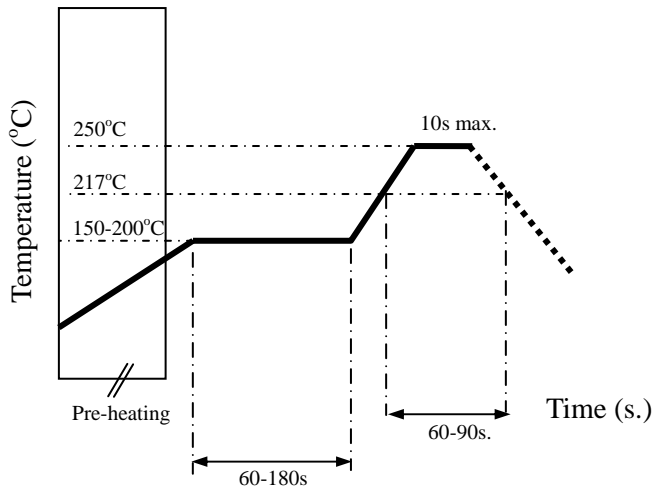

## Notes

❖ The contents of this data sheet are subject to change without notice. Please confirm the specifications and delivery conditions when placing your order.

### **Advanced Ceramic X Corp.**

16 Tzu Chiang Road, Hsinchu Industrial District Hsinchu Hsien 303, Taiwan

TEL:886-3-5987008 FAX:886-3-5987001

E-mail: [acx@acxc.com.tw](mailto:acx@acxc.com.tw)

<http://www.acxc.com.tw>

## X-ON Electronics

Largest Supplier of Electrical and Electronic Components

*Click to view similar products for [Signal Conditioning](#) category:*

*Click to view products by [ACX](#) manufacturer:*

Other Similar products are found below :

[MAPDCC0004](#) [PD0409J5050S2HF](#) [880157](#) [HHS-109-PIN](#) [DC1417J5005AHF](#) [DC4859J5005AHF](#) [AFS14A30-2185.00-T3](#) [AFS14A35-1591.50-T3](#) [DS-323-PIN](#) [DSS-313-PIN](#) [B39321R801H210](#) [B39321R821H210](#) [B39921B4317P810](#) [1A0220-3](#) [2089-6207-00](#) [JP510S](#) [LFB212G45SG8C341](#) [LFB322G45SN1A504](#) [LFL182G45TC3B746](#) [SF2159E](#) [30057](#) [1P510S](#) [CER0813B](#) [3A325](#) [40287](#) [41180](#) [ATB3225-75032NCT](#) [B69842N5807A150](#) [BD0810N50100AHF](#) [BD2326L50200AHF](#) [BD2425J50200AHF](#) [HMC189AMS8TR](#) [C5060J5003AHF](#) [JHS-114-PIN](#) [JP503AS](#) [DC0710J5005AHF](#) [DC2327J5005AHF](#) [DC3338J5005AHF](#) [43020](#) [LFB2H2G60BB1C106](#) [LFL15869MTC1B787](#) [X3C19F1-20S](#) [XC3500P-20S](#) [10013-20](#) [SF2081E](#) [SF2194E](#) [SF2238E](#) [CDBLB455KCAX39-B0](#) [RF1353C](#) [PD0922J5050D2HF](#)