

## Specifications

Current rating:4A AC,DC  
 Voltage rating:125V AC,DC  
 Temperature range:-40°C~+105°C  
 Contact resistance:10mΩMax.  
 Insulation resistance:1000MΩMin.  
 Withstanding voltage:1000V AC/minute  
 \*Compliant with RoHS and REACH\*  
 \*Meet the HF/Halogen Free,need to customize\*  
 \*Contact CJT for details\*

Standards



## Assembly layout

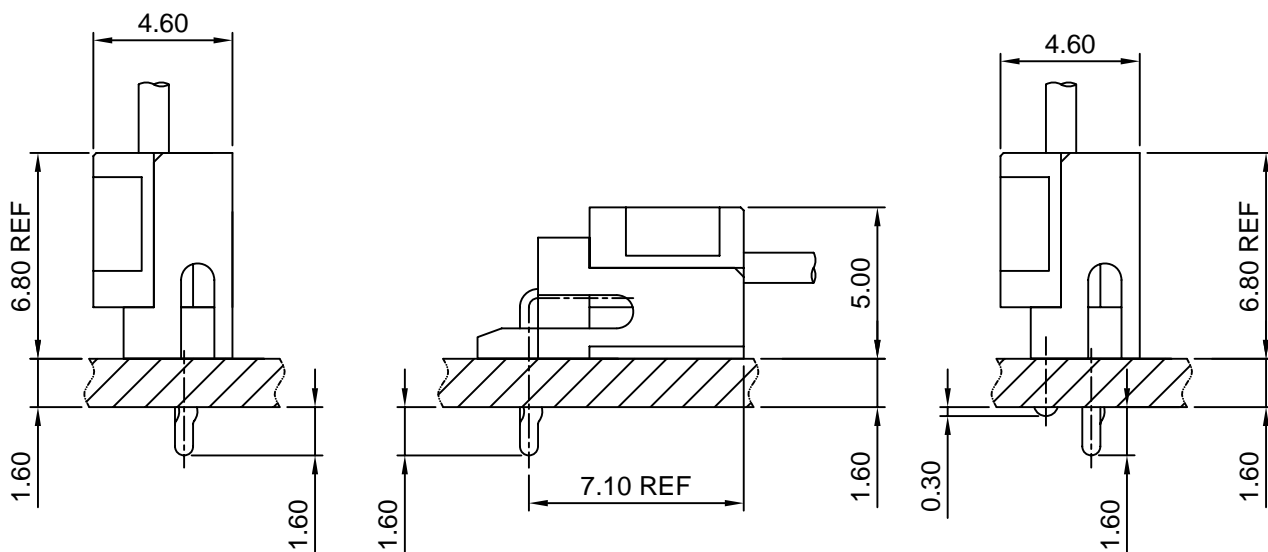

# A2007-T

2.00mm pitch Crimp Terminal

#### Reference Informations:

\*Used in CJT A2007H-XP series Housing

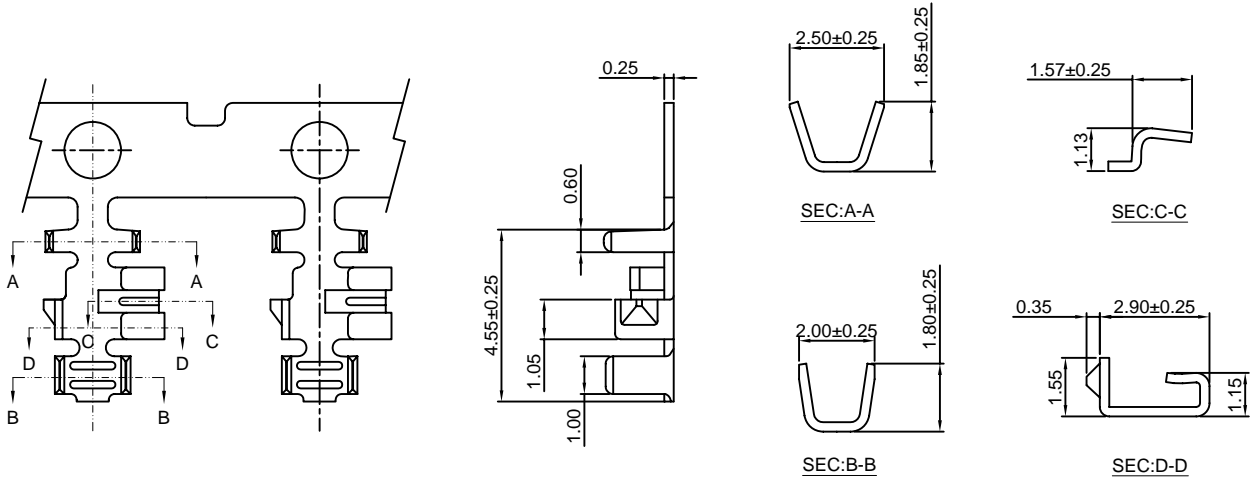

#### Ordering information & Specifications:

Unit:mm

Part NO.	Wire Range	Insulation O.D.	Material	Finish	Qty/reel
A2007-TP	AWG#22-#26	1.50mm(max)	Phosphor Bronze	Tin over Nickel	10,000 PCS
A2007-GP	AWG#22-#26	1.50mm(max)	Phosphor Bronze	Gold over Nickel	10,000 PCS

Optional Gold plating available but MOQ requested

# A2007H-XP

2.00mm pitch Housing

#### Reference Informations:

\*Material:Nylon 66,UL94V-0

\*Suitable CJT A2007-T series Terminal

\*Mates with CJT A2007WV,WR,WR-S,WR-S-F-XP, A2007WVD,WRD-XP series Wafer

\*Color:White

#### Ordering Information:

A2007H-XP - \*\*\* - \*\*  
1 2 3

1.Part No.

2.Material:

(Blank):Nylon 66,UL94V-0

GWT :Nylon 66,UL94V-0 GWT 750 °C

3.Color:

(Blank):White

BK:Black

BL:Blue

YL:Yellow

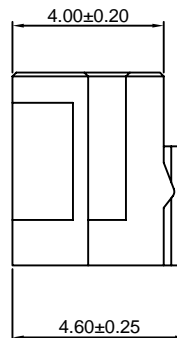
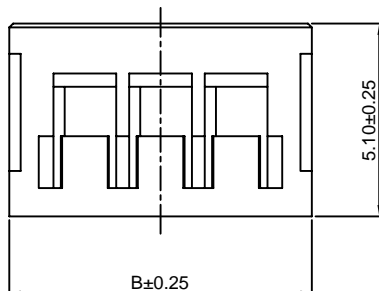
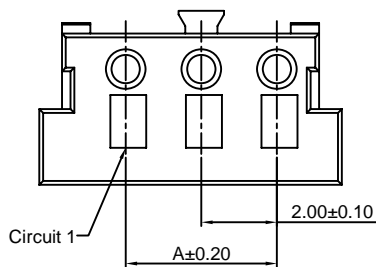
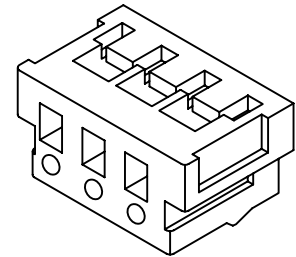

#### Ordering Information & Dimensions:

PART NO.	Dimensions	
	A	B
2P	2.00	5.60
3P	4.00	7.60
4P	6.00	9.60
5P	8.00	11.60
6P	10.00	13.60
7P	12.00	15.60
8P	14.00	17.60
9P	16.00	19.60
10P	18.00	21.60
11P	20.00	23.60
12P	22.00	25.60
13P	24.00	27.60
14P	26.00	29.60
15P	28.00	31.60

Unit: mm

## A2007HD-XP

2.00mm pitch IDC Housing

### Reference Informations:

- \*Material:  
Terminal: Phosphor Bronze/Tin over Nickel  
Housing: Nylon 66, UL94V-0
- \*Mates with CJT A2007WV, WR, WR-S, WR-S-F-XP, A2007WVD, WRD-XP series Wafer
- \*Color: White

Ordering Information:  
A2007HD-XP - \*\*\* - \*\*  
1 2 3

- 1. Part No.
- 2. Material:  
(Blank): Nylon 66, UL94V-0  
GWT: Nylon 66, UL94V-0 GWT 750 °C
- 3. Color:  
(Blank): White  
BK: Black  
BL: Blue  
YL: Yellow

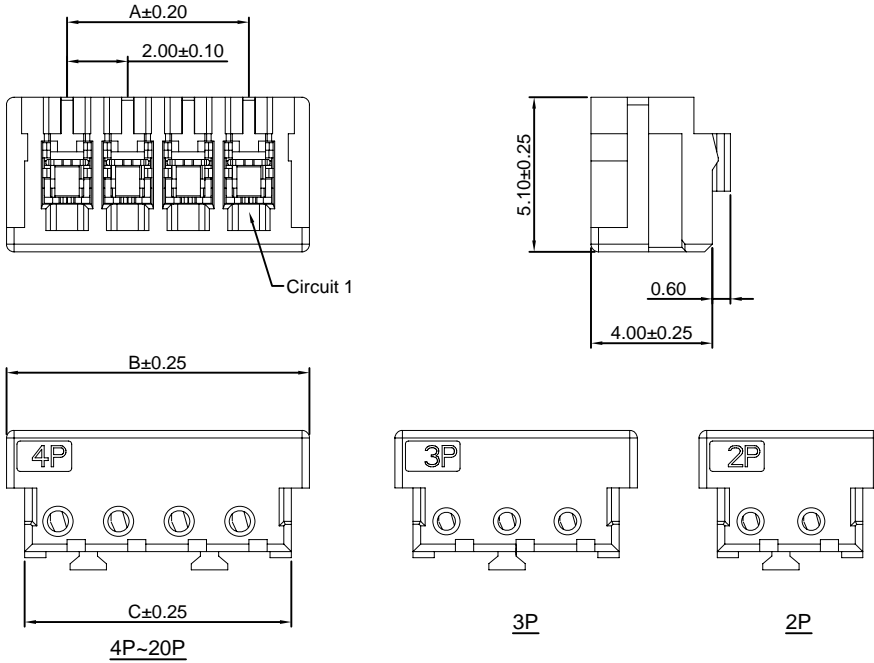

### Ordering Information & Dimensions:

PART NO.	Dimensions		
	A	B	C
2P	2.00	6.00	4.80
3P	4.00	8.00	6.80
4P	6.00	10.00	8.80
5P	8.00	12.00	10.80
6P	10.00	14.00	12.80
7P	12.00	16.00	14.80
8P	14.00	18.00	16.80
9P	16.00	20.00	18.80
10P	18.00	22.00	20.80
11P	20.00	24.00	22.80
12P	22.00	26.00	24.80
13P	24.00	28.00	26.80
14P	26.00	30.00	28.80
15P	28.00	32.00	30.80

Unit: mm

## A2007WV-XP

2.00mm pitch 180° Wafer

### Reference Informations:

- \*Material: Pin: Brass/Tin over Nickel  
Insulator: Nylon 66, UL94V-0
- \*Mates with CJT A2007H, HD-XP series Housing
- \*Color: White

Ordering Information:  
A2007WV-XP - \*\*\* - \*\*  
1 2 3

- 1. Part No.
- 2. Material:  
(Blank): Nylon 66, UL94V-0  
GWT: Nylon 66, UL94V-0 GWT 750 °C
- 3. Color:  
(Blank): White  
BK: Black  
BL: Blue  
YL: Yellow

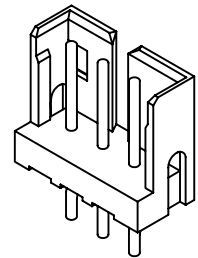
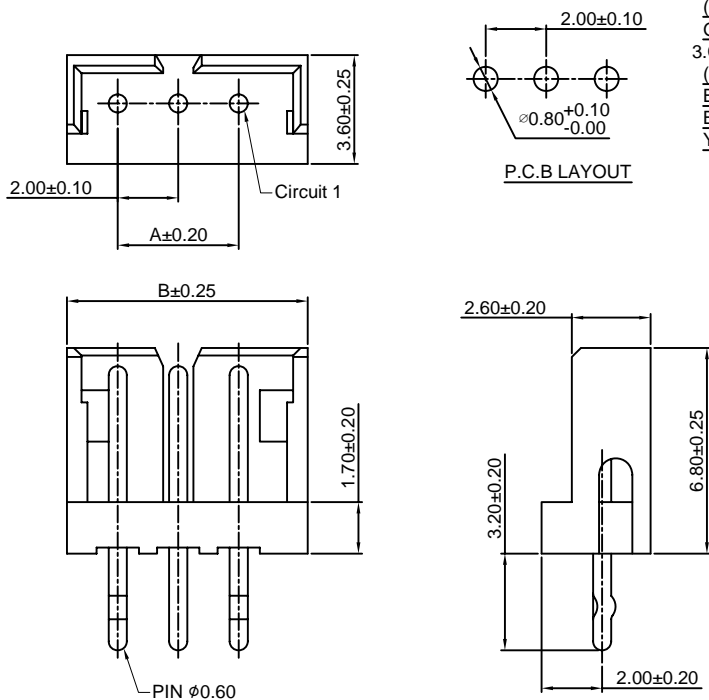

### Ordering Information & Dimensions:

PART NO.	Dimensions	
	A	B
2P	2.00	5.96
3P	4.00	7.96
4P	6.00	9.96
5P	8.00	11.96
6P	10.00	13.96
7P	12.00	15.96
8P	14.00	17.96
9P	16.00	19.96
10P	18.00	21.96
11P	20.00	23.96
12P	22.00	25.96
13P	24.00	27.96
14P	26.00	29.96
15P	28.00	31.96

Unit: mm

### A2007WR-XP

2.00mm pitch 90° Wafer

**Reference Informations:**

- \*Material:Pin:Brass/Tin over Nickel  
Insulator:Nylon 66,UL94V-0
- \*Mates with CJT A2007H,HD-XP series Housing
- \*Color:White

Ordering Information:  
A2007WR-XP - \*\*\* - \*\*  
1 2 3

- 1.Part No.
- 2.Material:  
(Blank):Nylon 66,UL94V-0  
GWT :Nylon 66,UL94V-0 GWT 750 °C
- 3.Color:  
(Blank):White  
BK:Black  
BL:Blue  
YL:Yellow

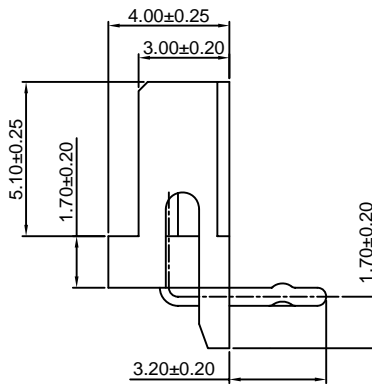
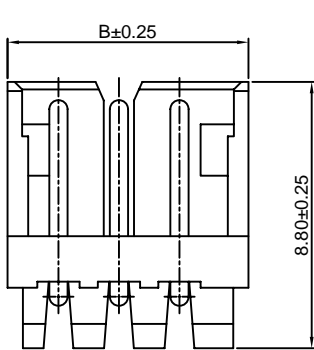
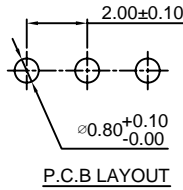
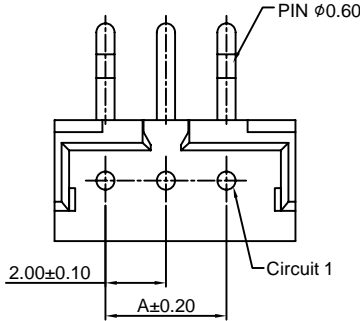
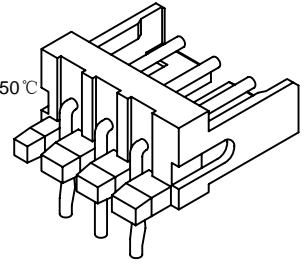

**Ordering Information & Dimensions:**

PART NO.	Dimensions	
	A	B
2P	2.00	5.96
3P	4.00	7.96
4P	6.00	9.96
5P	8.00	11.96
6P	10.00	13.96
7P	12.00	15.96
8P	14.00	17.96
9P	16.00	19.96
10P	18.00	21.96
11P	20.00	23.96
12P	22.00	25.96
13P	24.00	27.96
14P	26.00	29.96
15P	28.00	31.96

Unit: mm

### A2007WVD-XP

2.00mm pitch 180° Wafer

**Reference Informations:**

- \*Material:Pin:Brass/Tin over Nickel  
Insulator:Nylon 66,UL94V-0
- \*Mates with CJT A2007H,HD-XP series Housing
- \*Color:White

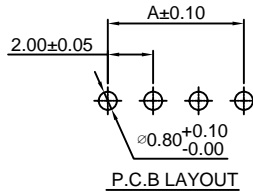

Ordering Information:  
A2007WVD-XP - \*\*\* - \*\*  
1 2 3

- 1.Part No.
- 2.Material:  
(Blank):Nylon 66,UL94V-0  
GWT :Nylon 66,UL94V-0 GWT 750 °C
- 3.Color:  
(Blank):White  
BK:Black  
BL:Blue  
YL:Yellow

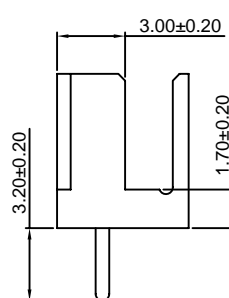
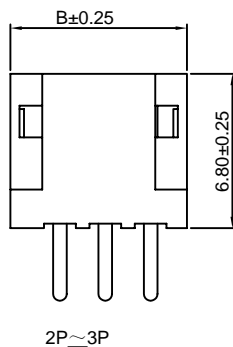
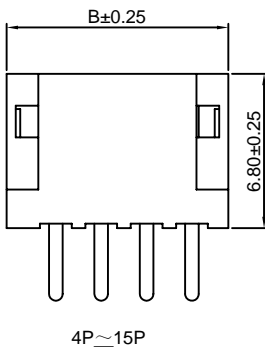
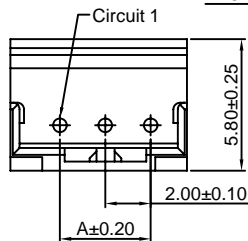
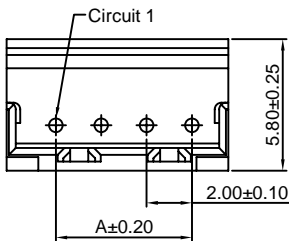
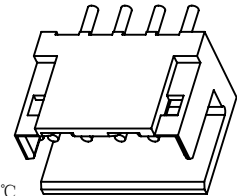

**Ordering Information & Dimensions:**

PART NO.	Dimensions	
	A	B
2P	2.00	5.80
3P	4.00	7.80
4P	6.00	9.80
5P	8.00	11.80
6P	10.00	13.80
7P	12.00	15.80
8P	14.00	17.80
9P	16.00	19.80
10P	18.00	21.80
11P	20.00	23.80
12P	22.00	25.80
13P	24.00	27.80
14P	26.00	29.80
15P	28.00	31.80

Unit: mm

### A2007WRD-XP

2.00mm pitch 90° Wafer

**Reference Informations:**

- \*Material:Pin:Brass/Tin over Nickel  
Insulator:Nylon 66,UL94V-0
- \*Mates with CJT A2007H,HD-XP series Housing
- \*Color:White

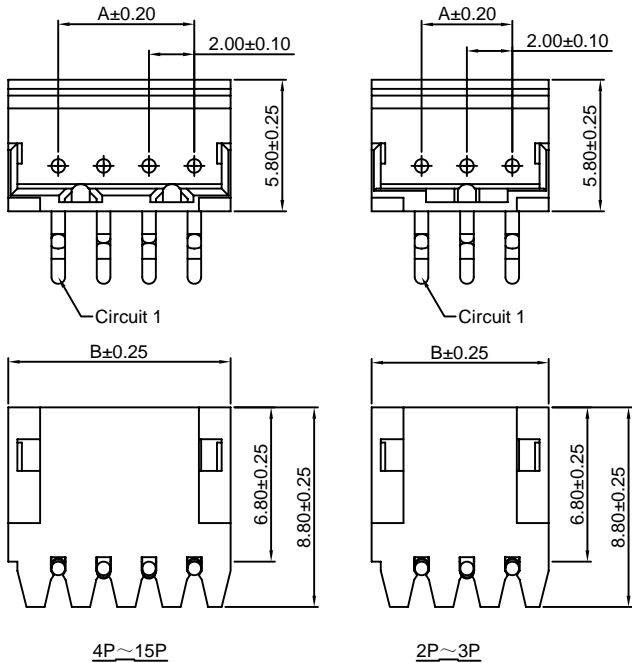
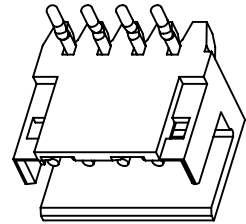
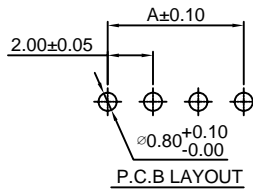

Ordering Information:  
A2007WRD-XP - \*\*\* - \*\*  
1 2 3

- 1.Part No.
- 2.Material:  
(Blank):Nylon 66,UL94V-0  
GWT :Nylon 66,UL94V-0 GWT 750°C
- 3.Color:  
(Blank):White  
BK:Black  
BL:Blue  
YL:Yellow

**Ordering Information & Dimensions:**

PART NO.	Dimensions	
	A	B
2P	2.00	5.80
3P	4.00	7.80
4P	6.00	9.80
5P	8.00	11.80
6P	10.00	13.80
7P	12.00	15.80
8P	14.00	17.80
9P	16.00	19.80
10P	18.00	21.80
11P	20.00	23.80
12P	22.00	25.80
13P	24.00	27.80
14P	26.00	29.80
15P	28.00	31.80

Unit: mm

### A2007WV-F-3P

2.00mm pitch 180° Wafer With Foot

**Reference Informations:**

- \*Material:Pin:Brass/Tin over Nickel  
Insulator:Nylon 66,UL94V-0
- \*Mates with CJT A2007H,HD-3P series Housing
- \*Color:White

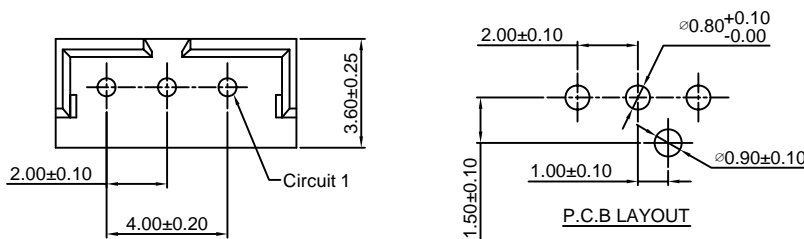

Ordering Information:  
A2007WV-F-3P - \*\*\* - \*\*  
1 2 3

- 1.Part No.
- 2.Material:  
(Blank):Nylon 66,UL94V-0  
GWT :Nylon 66,UL94V-0 GWT 750°C
- 3.Color:  
(Blank):White  
BK:Black  
BL:Blue  
YL:Yellow

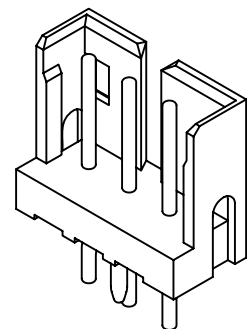
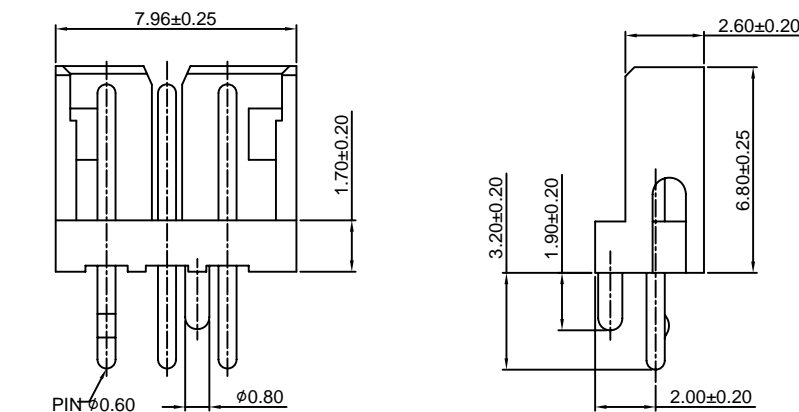

Unit: mm

### A2007WR-S-XP

2.00mm pitch 90° Wafer - SMT TYPE

**Reference Informations:**

- \*Material:Pin:Brass/Tin over Nickel  
Insulator:Nylon 6T,UL94V-0
- \*Mates with CJT A2007H,HD-XP series Housing
- \*Color:Beige

**Ordering Information:**

- A2007WR-S-XP - \*\*\* - \*\*
- |   |   |   |
|---|---|---|
| 1 | 2 | 3 |
|---|---|---|
- Part No.
  - Material:  
(Blank):Nylon 66,UL94V-0  
GWT :Nylon 66,UL94V-0 GWT 750°C
  - Color:  
(Blank):Beige  
BK:Black  
BL:Blue  
YL:Yellow

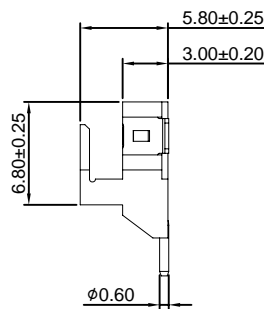
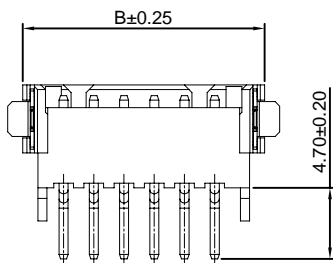
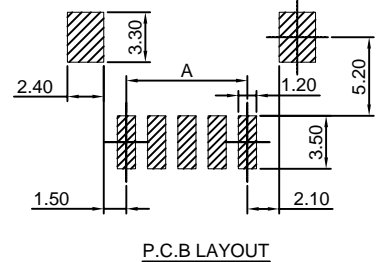
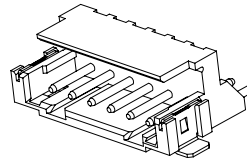
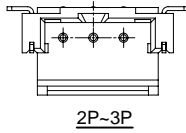
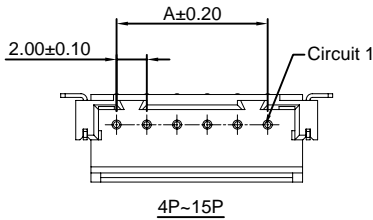

PART NO.	Dimensions	
	A	B
2P	2.00	8.00
3P	4.00	10.00
4P	6.00	12.00
5P	8.00	14.00
6P	10.00	16.00
7P	12.00	18.00
8P	14.00	20.00
9P	16.00	22.00
10P	18.00	24.00
11P	20.00	26.00
12P	22.00	28.00
13P	24.00	30.00
14P	26.00	32.00
15P	28.00	34.00

Unit: mm

### A2007WR-S-F-XP

2.00mm pitch 90° Wafer - SMT TYPE

**Reference Informations:**

- \*Material:Pin:Brass/Tin over Nickel  
Insulator:Nylon 6T,UL94V-0
- \*Mates with CJT A2007H,HD-XP series Housing
- \*Color:Beige

**Ordering Information:**

- A2007WR-S-F-XP - \*\*\* - \*\*
- |   |   |   |
|---|---|---|
| 1 | 2 | 3 |
|---|---|---|
- Part No.
  - Material:  
(Blank):Nylon 66,UL94V-0  
GWT :Nylon 66,UL94V-0 GWT 750°C
  - Color:  
(Blank):Beige  
BK:Black  
BL:Blue  
YL:Yellow

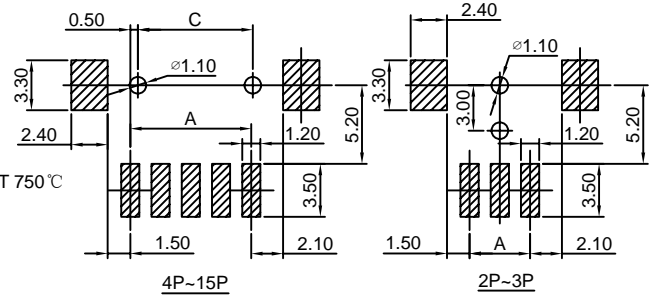
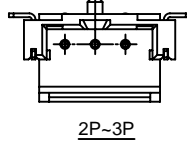
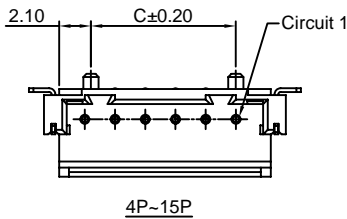

P.C.B LAYOUT

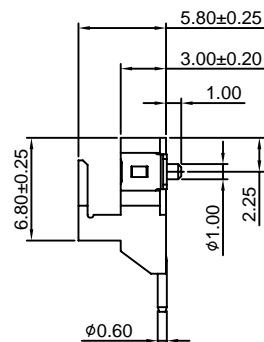
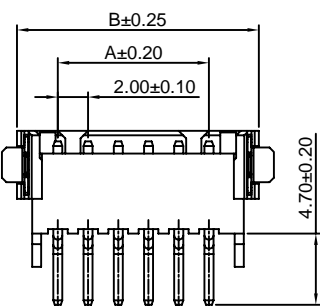

PART NO.	Dimensions		
	A	B	C
2P	2.00	8.00	----
3P	4.00	10.00	----
4P	6.00	12.00	5.60
5P	8.00	14.00	7.60
6P	10.00	16.00	9.60
7P	12.00	18.00	11.60
8P	14.00	20.00	13.60
9P	16.00	22.00	15.60
10P	18.00	24.00	17.60
11P	20.00	26.00	19.60
12P	22.00	28.00	21.60
13P	24.00	30.00	23.60
14P	26.00	32.00	25.60
15P	28.00	34.00	27.60

Unit: mm

## X-ON Electronics

Largest Supplier of Electrical and Electronic Components

*Click to view similar products for [Headers & Wire Housings](#) category:*

*Click to view products by [Changjiang](#) manufacturer:*

Other Similar products are found below :

[95000-104TRLF](#) [10135584-644402LF](#) [DF62W-EP2022PCA](#) [95000-106TRLF](#) [DF62W-2022SCA](#) [DF62W-EP2022PC](#) [2203348](#) [DF62W-2022SC](#) [1084018](#) [1029039](#) [1084017](#) [802-10-012-10-002000](#) [1112640](#) [1112639](#) [891-007-9SS-BST1T](#) [000-34000](#) [0008550134](#) [0009482033](#) [0009507031](#) [57102-F02-18ULF](#) [57102-S06-03LF](#) [57202-S52-04LF](#) [PCN6-15S-2.5E](#) [0039019024](#) [58102-G61-06LF](#) [582553-1](#) [0009485154](#) [0009508121](#) [0022285053](#) [0050291907](#) [018731A](#) [LY20-4P-DT1-P1E-BR](#) [02.125.8002.8](#) [60101931](#) [60598-1 \(Cut Strip\)](#) [M1625-3R/100](#) [61062-3](#) [61082-181009](#) [CSU011177004](#) [636-1427](#) [638009-1](#) [641938-9](#) [641991-4](#) [644168-1](#) [644827-2](#) [647662-1](#) [65039-019ELF](#) [65692-001LF](#) [65781-018](#) [65781-047](#)