

Specifications

- Current rating:3A AC,DC
- Voltage rating:250V AC,DC
- Temperature range:-40°C~+105°C
- Contact resistance:20mΩ Max.
- Insulation resistance:1000MΩ Min.
- Withstanding voltage:1500V AC/minute
- *Compliant with RoHS and REACH*
- *Meet the HF/Halogen Free,need to customize*
- *Contact CJT for details*

Standards



A2547-T

2.54mm Pitch Crimp Terminal

Reference Informations:

*Used in CJT A2547 series Housing

Use With CJT A2547 series Housing :

| | |
|------------|---|
| Single Row | A2547H-XP, A2547H-XP-2, A2547H-XP-3, A2547HE-XP |
| | A2547HG-XP, A2547HC-2P, A2547HD-2P, A2547HU-XP |
| Dual Row | A2547H-2xXP, A2547HA-2xXP, A2547HD-2xXP, A2547HN-2xXP |
| | A2547HF-2xXP, A2547HG-2xXP, A2547HJ-2xXP |

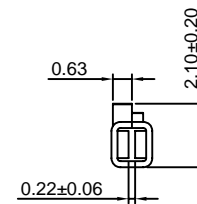
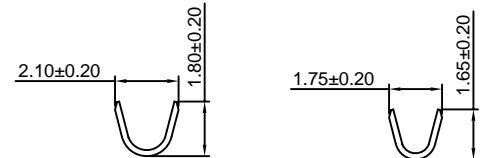

Ordering information & Specifications:

Unit:mm

| Part NO. | Wire Range | Insulation O.D. | Material | Finish | Qty/reel |
|----------|------------|-----------------|-----------------|------------------|------------|
| A2547-TP | AWG#22-#24 | 1.60mm(max) | Phosphor Bronze | Tin over Nickel | 15,000 PCS |
| A2547-GP | AWG#22-#24 | 1.60mm(max) | Phosphor Bronze | Gold over Nickel | 15,000 PCS |

Optional Gold plating available but MOQ requested

A2547-T-L

2.54mm Pitch Crimp Terminal

Reference Informations:

*Used in CJT A2547 series Housing

Use With CJT A2547 series Housing :

| | |
|------------|---|
| Single Row | A2547H-XP, A2547H-XP-2, A2547H-XP-3, A2547HE-XP |
| | A2547HG-XP, A2547HC-2P, A2547HD-2P, A2547HU-XP |
| Dual Row | A2547H-2xXP, A2547HA-2xXP, A2547HD-2xXP, A2547HN-2xXP |
| | A2547HF-2xXP, A2547HG-2xXP, A2547HJ-2xXP |

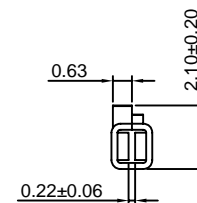
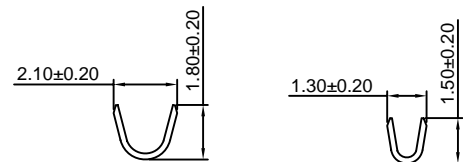
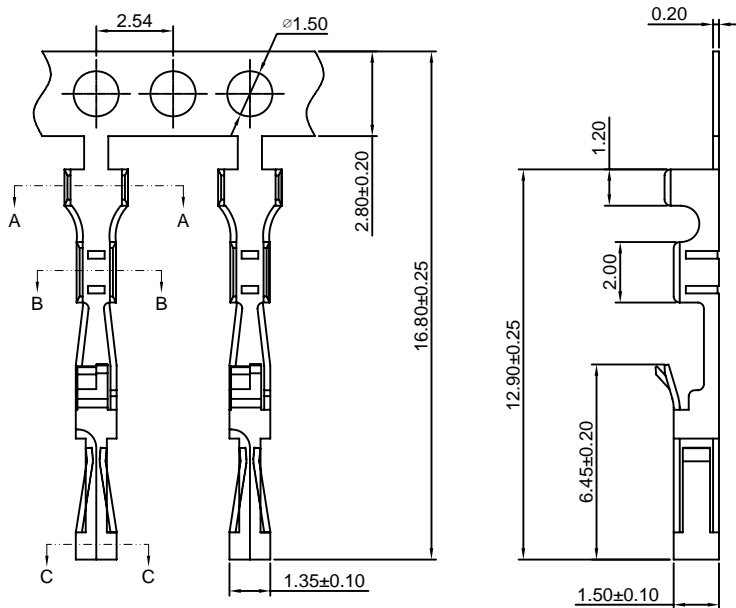

Ordering information & Specifications:

Unit:mm

| Part NO. | Wire Range | Insulation O.D. | Material | Finish | Qty/reel |
|------------|------------|-----------------|-----------------|------------------|------------|
| A2547-TP-L | AWG#24-#30 | 1.60mm(max) | Phosphor Bronze | Tin over Nickel | 15,000 PCS |
| A2547-GP-L | AWG#24-#30 | 1.60mm(max) | Phosphor Bronze | Gold over Nickel | 15,000 PCS |

Optional Gold plating available but MOQ requested

A2547-T-C

2.54mm Pitch Crimp Terminal

Reference Informations:

*Used in CJT A2547 series Housing



Use With CJT A2547 series Housing :

| | |
|------------|---|
| Single Row | A2547H-XP, A2547H-XP-2, A2547H-XP-3, A2547HE-XP |
| | A2547HG-XP, A2547HC-2P, A2547HD-2P, A2547HU-XP |
| Dual Row | A2547H-2xXP, A2547HA-2xXP, A2547HD-2xXP, A2547HN-2xXP |
| | A2547HF-2xXP, A2547HG-2xXP, A2547HJ-2xXP |



Ordering information & Specifications:

Unit:mm

| Part NO. | Wire Range | Insulation O.D. | Material | Finish | Qty/reel |
|------------|------------|-----------------|-----------------|------------------|------------|
| A2547-TP-C | AWG#22-#24 | 1.60mm(max) | Phosphor Bronze | Tin over Nickel | 15,000 PCS |
| A2547-GP-C | AWG#22-#24 | 1.60mm(max) | Phosphor Bronze | Gold over Nickel | 15,000 PCS |

Optional Gold plating available but MOQ requested

A2547-T-C-L

2.54mm Pitch Crimp Terminal

Reference Informations:

*Used in CJT A2547 series Housing



Use With CJT A2547 series Housing :

| | |
|------------|---|
| Single Row | A2547H-XP, A2547H-XP-2, A2547H-XP-3, A2547HE-XP |
| | A2547HG-XP, A2547HC-2P, A2547HD-2P, A2547HU-XP |
| Dual Row | A2547H-2xXP, A2547HA-2xXP, A2547HD-2xXP, A2547HN-2xXP |
| | A2547HF-2xXP, A2547HG-2xXP, A2547HJ-2xXP |



Ordering information & Specifications:

Unit:mm

| Part NO. | Wire Range | Insulation O.D. | Material | Finish | Qty/reel |
|--------------|------------|-----------------|-----------------|------------------|------------|
| A2547-TP-C-L | AWG#24-#30 | 1.60mm(max) | Phosphor Bronze | Tin over Nickel | 15,000 PCS |
| A2547-GP-C-L | AWG#24-#30 | 1.60mm(max) | Phosphor Bronze | Gold over Nickel | 15,000 PCS |

Optional Gold plating available but MOQ requested

A2547-T-B

2.54mm Pitch Crimp Terminal

Reference Informations:

*Used in CJT A2547HA,HB-XP,A2549H,HA-XP,A2549H-2xXP series Housing

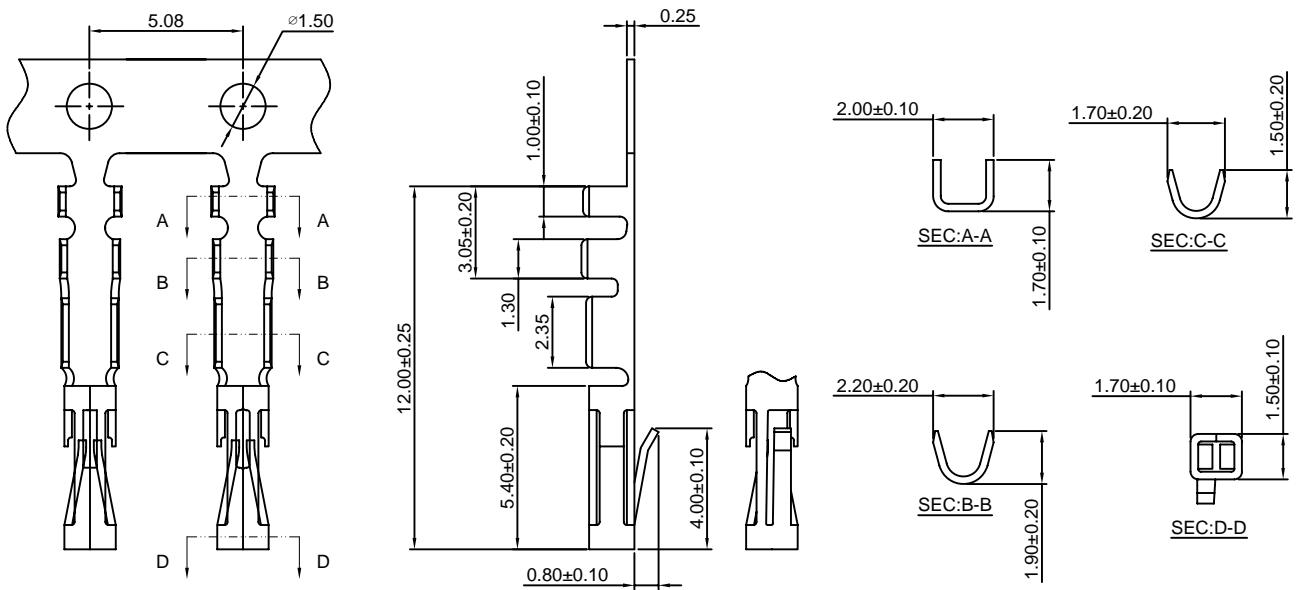

Ordering information & Specifications:

Unit:mm

| Part NO. | Wire Range | Insulation O.D. | Material | Finish | Qty/reel |
|------------|------------|-----------------|-----------------|------------------|------------|
| A2547-TP-B | AWG#22-#26 | 1.55mm(max) | Phosphor Bronze | Tin over Nickel | 20,000 PCS |
| A2547-GP-B | AWG#22-#26 | 1.55mm(max) | Phosphor Bronze | Gold over Nickel | 20,000 PCS |

Optional Gold plating available but MOQ requested

A2547-T-D

2.54mm Pitch Insulation Displacement Terminal

Reference Informations:

*Used in CJT A2547 series Housing

Use With CJT A2547 series Housing :

| | |
|------------|--|
| Single Row | A2547H-XP,A2547H-XP-2,A2547H-XP-3,A2547HE-XP |
| | A2547HG-XP,A2547HC-2P,A2547HD-2P,A2547HJ-XP |
| Dual Row | A2547H-2xXP,A2547HA-2xXP,A2547HD-2xXP,A2547HN-2xXP |
| | A2547HF-2xXP,A2547HG-2xXP,A2547HJ-2xXP |

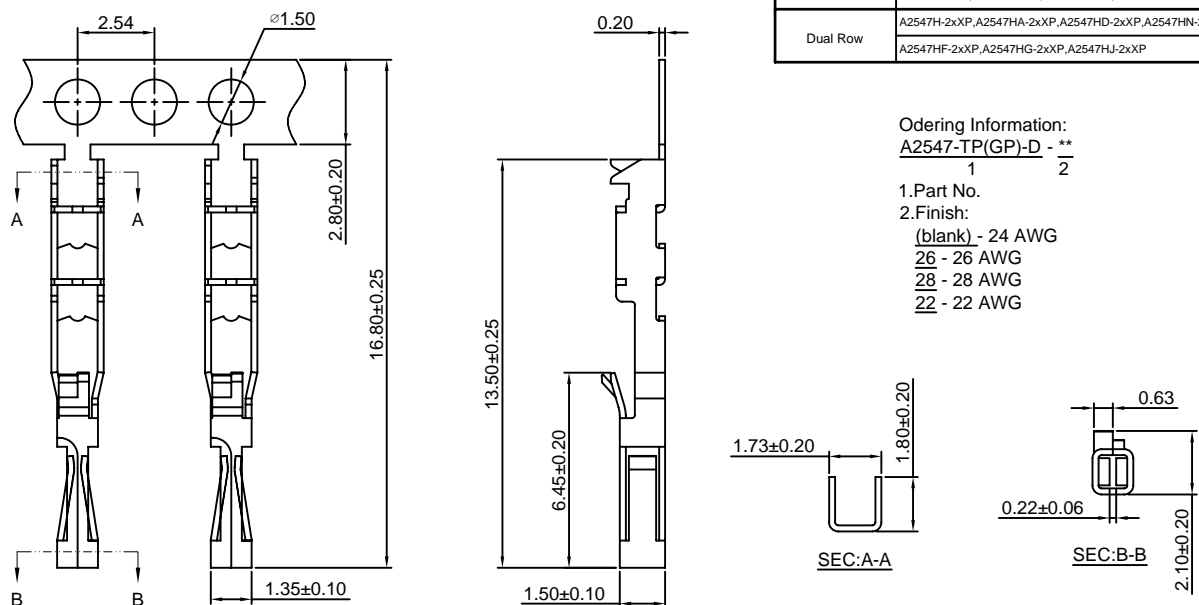

Odering Information:

A2547-TP(GP)-D - **

1. Part No.

2. Finish:

(blank) - 24 AWG

26 - 26 AWG

28 - 28 AWG

22 - 22 AWG

Ordering information & Specifications:

Unit:mm

| Part NO. | Wire Range | Insulation O.D. | Material | Finish | Qty/reel |
|------------|------------|-----------------|-----------------|------------------|------------|
| A2547-TP-D | AWG#22-#28 | 1.60mm(max) | Phosphor Bronze | Tin over Nickel | 15,000 PCS |
| A2547-GP-D | AWG#22-#28 | 1.60mm(max) | Phosphor Bronze | Gold over Nickel | 15,000 PCS |

Optional Gold plating available but MOQ requested

A2547-T-S

2.54mm Pitch Crimp Terminal

Reference Informations:

*Used in CJT A2547HS, HSA-2xXP series Housing



Ordering information & Specifications:

Unit:mm

| Part NO. | Wire Range | Insulation O.D. | Material | Finish | Qty/reel |
|------------|------------|-----------------|-----------------|------------------|------------|
| A2547-TP-S | AWG#22-#28 | 1.63mm(max) | Phosphor Bronze | Tin over Nickel | 10,000 PCS |
| A2547-GP-S | AWG#22-#28 | 1.63mm(max) | Phosphor Bronze | Gold over Nickel | 10,000 PCS |

Optional Gold plating available but MOQ requested

A2547M-T

2.54mm Pitch Crimp Terminal

Reference Informations:

*Used in CJT A2547HM, HMA-XP, A2547H-XP-2, A2547H-XP-3, A2547HE-XP, A2547HF-2xXP series Housing

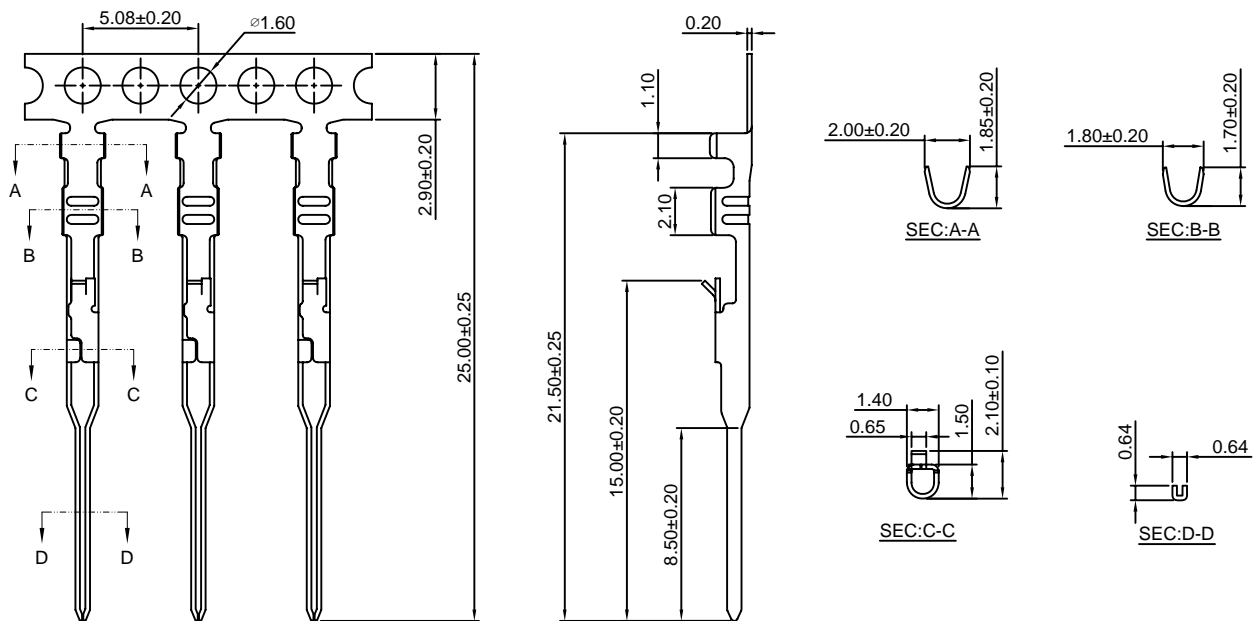

Ordering information & Specifications:

Unit:mm

| Part NO. | Wire Range | Insulation O.D. | Material | Finish | Qty/reel |
|-----------|------------|-----------------|-----------------|------------------|------------|
| A2547M-TP | AWG#22-#24 | 1.60mm(max) | Phosphor Bronze | Tin over Nickel | 15,000 PCS |
| A2547M-GP | AWG#22-#24 | 1.60mm(max) | Phosphor Bronze | Gold over Nickel | 15,000 PCS |

Optional Gold plating available but MOQ requested

A2547M-T-L

2.54mm Pitch Crimp Terminal

Reference Informations:

*Used in CJT A2547HM,HMA-XP,A2547H-XP-2,A2547H-XP-3,A2547HE-XP,A2547HF-2xXP series Housing

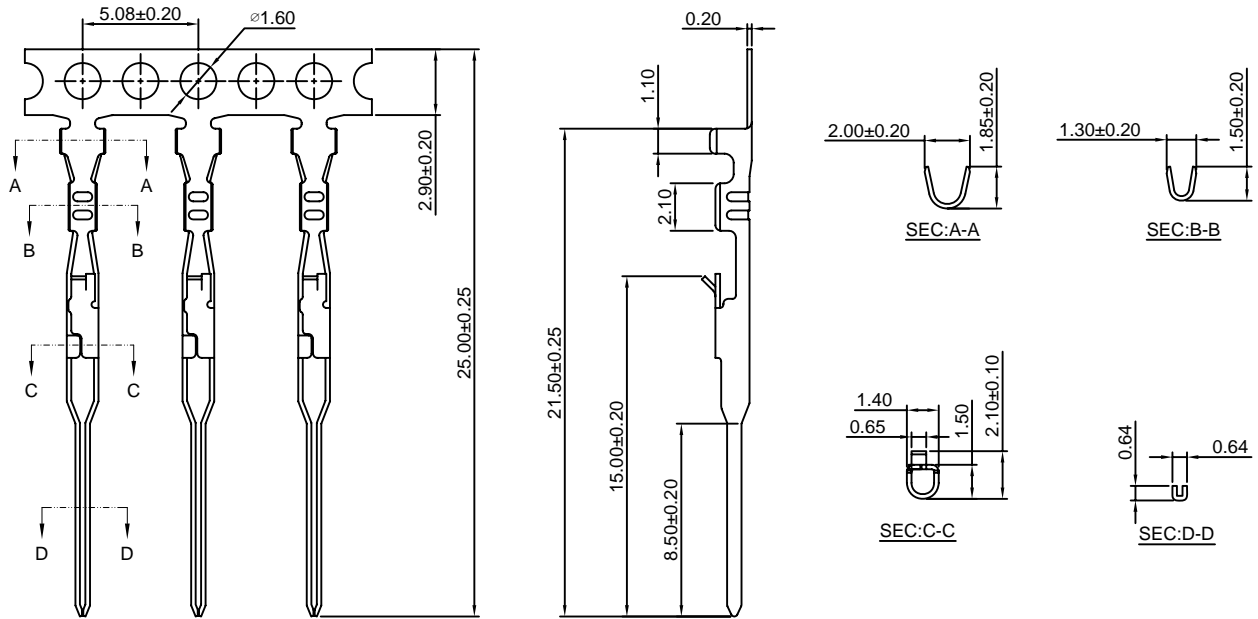

Ordering information & Specifications:

Unit:mm

| Part NO. | Wire Range | Insulation O.D. | Material | Finish | Qty/reel |
|-------------|------------|-----------------|-----------------|------------------|------------|
| A2547M-TP-L | AWG#24-#30 | 1.60mm(max) | Phosphor Bronze | Tin over Nickel | 15,000 PCS |
| A2547M-GP-L | AWG#24-#30 | 1.60mm(max) | Phosphor Bronze | Gold over Nickel | 15,000 PCS |

Optional Gold plating available but MOQ requested

A2547M-T-B

2.54mm Pitch Crimp Terminal

Reference Informations:

*Used in CJT A2547HMB-XP series Housing



Ordering information & Specifications:

Unit:mm

| Part NO. | Wire Range | Insulation O.D. | Material | Finish | Qty/reel |
|-------------|------------|-----------------|-----------------|------------------|------------|
| A2547M-TP-B | AWG#22-#26 | 1.63mm(max) | Phosphor Bronze | Tin over Nickel | 15,000 PCS |
| A2547M-GP-B | AWG#22-#26 | 1.63mm(max) | Phosphor Bronze | Gold over Nickel | 15,000 PCS |

Optional Gold plating available but MOQ requested

A2547H-XP

2.54mm Pitch Housing With Lock

Reference Informations:

- *Material:PBT,UL94V-0
- *Suitable CJT A2547-T(-L) A2547-T-C(-L) A2547-T-D series Terminal
- *Mates with CJT A2547HM,HMA,HMB-XP series Housing or A2547WV,WR,WVA,WRA-XP,A2547WR-F,WR-S-F-XP series single row Wafer
- *Color:Black

Ordering Information:

- A2547H-XP - ***
 1 2
- 1.Part No.
 - 2.Material:
 (Blank):PBT,UL94V-0
 GWT:PBT,UL94V-0,GWT 750°C

Ordering Information & Dimensions:

| PART NO. | Dimensions | |
|----------|------------|-------|
| | A | B |
| 2P | 2.54 | 5.08 |
| 3P | 5.08 | 7.62 |
| 4P | 7.62 | 10.16 |
| 5P | 10.16 | 12.70 |
| 6P | 12.70 | 15.24 |
| 7P | 15.24 | 17.78 |
| 8P | 17.78 | 20.32 |
| 9P | 20.32 | 22.86 |
| 10P | 22.86 | 25.40 |
| 11P | 25.40 | 27.94 |
| 12P | 27.94 | 30.48 |
| 13P | 30.48 | 33.02 |
| 14P | 33.02 | 35.56 |
| 15P | 35.56 | 38.10 |
| 16P | 38.10 | 40.64 |
| 17P | 40.64 | 43.18 |
| 18P | 43.18 | 45.72 |
| 19P | 45.72 | 48.26 |
| 20P | 48.26 | 50.80 |
| 21P | 50.80 | 53.34 |
| 22P | 53.34 | 55.88 |
| 23P | 55.88 | 58.42 |
| 24P | 58.42 | 60.96 |
| 25P | 60.96 | 63.50 |

Unit: mm



A2547H-XP-2

2.54mm Pitch Housing

Reference Informations:

- *Material:PBT,UL94V-0
- *Suitable CJT A2547-T(-L) A2547M-T(-L) A2547-T-C(-L) A2547-T-D series Terminal
- *Mates with CJT A2547 series single row Housing or A2547 A2541 series single row Wafer
- *Color:Black

Ordering Information:

- A2547H-XP-2 - ***
 1 2
- 1.Part No.
 - 2.Material:
 (Blank):PBT,UL94V-0
 GWT:PBT,UL94V-0,GWT 750°C

Ordering Information & Dimensions:

| PART NO. | Dimensions | |
|----------|------------|-------|
| | A | B |
| 1P | ---- | 2.54 |
| 2P | 2.54 | 5.08 |
| 3P | 5.08 | 7.62 |
| 4P | 7.62 | 10.16 |
| 5P | 10.16 | 12.70 |
| 6P | 12.70 | 15.24 |
| 7P | 15.24 | 17.78 |
| 8P | 17.78 | 20.32 |
| 9P | 20.32 | 22.86 |
| 10P | 22.86 | 25.40 |
| 11P | 25.40 | 27.94 |
| 12P | 27.94 | 30.48 |
| 13P | 30.48 | 33.02 |
| 14P | 33.02 | 35.56 |
| 15P | 35.56 | 38.10 |
| 16P | 38.10 | 40.64 |
| 17P | 40.64 | 43.18 |
| 18P | 43.18 | 45.72 |
| 19P | 45.72 | 48.26 |
| 20P | 48.26 | 50.80 |
| 21P | 50.80 | 53.34 |
| 22P | 53.34 | 55.88 |
| 23P | 55.88 | 58.42 |
| 24P | 58.42 | 60.96 |
| 25P | 60.96 | 63.50 |

Unit: mm



A2547HB-XP

2.54mm Pitch Housing

Reference Informations:

- *Material:PBT,UL94V-0
- *Suitable CJT A2547-T-B series Terminal
- *Mates with CJT A2547 series single row Housing or A2547 A2541 series single row Wafer
- *Color:Black



Ordering Information:

A2547HB-XP - ***
1 2

- 1.Part No.
- 2.Material:
(Blank):PBT,UL94V-0
GWT:PBT,UL94V-0,GWT 750°C

Ordering Information & Dimensions:

| PART NO. | Dimensions | |
|----------|------------|-------|
| | A | B |
| 2P | 2.54 | 4.92 |
| 3P | 5.08 | 7.46 |
| 4P | 7.62 | 10.00 |
| 5P | 10.16 | 12.54 |
| 6P | 12.70 | 15.08 |
| 7P | 15.24 | 17.62 |
| 8P | 17.78 | 20.16 |
| 9P | 20.32 | 22.70 |
| 10P | 22.86 | 25.24 |
| 11P | 25.40 | 27.78 |
| 12P | 27.94 | 30.32 |
| 13P | 30.48 | 32.86 |
| 14P | 33.02 | 35.40 |
| 15P | 35.56 | 37.94 |
| 16P | 38.10 | 40.48 |
| 17P | 40.64 | 43.02 |
| 18P | 43.18 | 45.56 |
| 19P | 45.72 | 48.10 |
| 20P | 48.26 | 50.64 |
| 21P | 50.80 | 53.18 |
| 22P | 53.34 | 55.72 |
| 23P | 55.88 | 58.26 |
| 24P | 58.42 | 60.80 |
| 25P | 60.96 | 63.34 |

Unit: mm

A2547HE-XP

2.54mm Pitch Housing

Reference Informations:

- *Material:PBT,UL94V-0
- *Suitable CJT A2547-T(-L) A2547M-T(-L) A2547-T-C(-L) A2547-T-D series Terminal
- *Color:Black



Ordering Information:

A2547HE-XP - ***
1 2

- 1.Part No.
- 2.Material:
(Blank):PBT,UL94V-0
GWT:PBT,UL94V-0,GWT 750°C

Ordering Information & Dimensions:

| PART NO. | Dimensions | |
|----------|------------|-------|
| | A | B |
| 2P | 2.54 | 5.08 |
| 3P | 5.08 | 7.62 |
| 4P | 7.62 | 10.16 |
| 5P | 10.16 | 12.70 |
| 6P | 12.70 | 15.24 |
| 7P | 15.24 | 17.78 |
| 8P | 17.78 | 20.32 |
| 9P | 20.32 | 22.86 |
| 10P | 22.86 | 25.40 |
| 11P | 25.40 | 27.94 |
| 12P | 27.94 | 30.48 |
| 13P | 30.48 | 33.02 |
| 14P | 33.02 | 35.56 |
| 15P | 35.56 | 38.10 |
| 16P | 38.10 | 40.64 |
| 17P | 40.64 | 43.18 |
| 18P | 43.18 | 45.72 |
| 19P | 45.72 | 48.26 |
| 20P | 48.26 | 50.80 |
| 21P | 50.80 | 53.34 |
| 22P | 53.34 | 55.88 |
| 23P | 55.88 | 58.42 |
| 24P | 58.42 | 60.96 |
| 25P | 60.96 | 63.50 |

Unit: mm

A2547HG-XP

2.54mm Pitch Housing

Reference Informations:

- *Material: PBT, UL94V-0
- *Suitable CJT A2547-T(-L) A2547-T-C(-L) A2547-T-D series Terminal
- *Color: Black

Ordering Information:

A2547HG-XP - ***

- | | |
|-------------------------------|---|
| 1 | 2 |
| 1. Part No. | |
| 2. Material: | |
| (Blank): PBT, UL94V-0 | |
| GWT: PBT, UL94V-0, GWT 750 °C | |

Ordering Information & Dimensions:

| PART NO. | Dimensions | |
|----------|------------|-------|
| | A | B |
| 2P | 2.54 | 5.08 |
| 3P | 5.08 | 7.62 |
| 4P | 7.62 | 10.16 |
| 5P | 10.16 | 12.70 |
| 6P | 12.70 | 15.24 |
| 7P | 15.24 | 17.78 |
| 8P | 17.78 | 20.32 |
| 9P | 20.32 | 22.86 |
| 10P | 22.86 | 25.40 |
| 11P | 25.40 | 27.94 |
| 12P | 27.94 | 30.48 |
| 13P | 30.48 | 33.02 |
| 14P | 33.02 | 35.56 |
| 15P | 35.56 | 38.10 |
| 16P | 38.10 | 40.64 |
| 17P | 40.64 | 43.18 |
| 18P | 43.18 | 45.72 |
| 19P | 45.72 | 48.26 |
| 20P | 48.26 | 50.80 |
| 21P | 50.80 | 53.34 |
| 22P | 53.34 | 55.88 |
| 23P | 55.88 | 58.42 |
| 24P | 58.42 | 60.96 |
| 25P | 60.96 | 63.50 |

Unit: mm

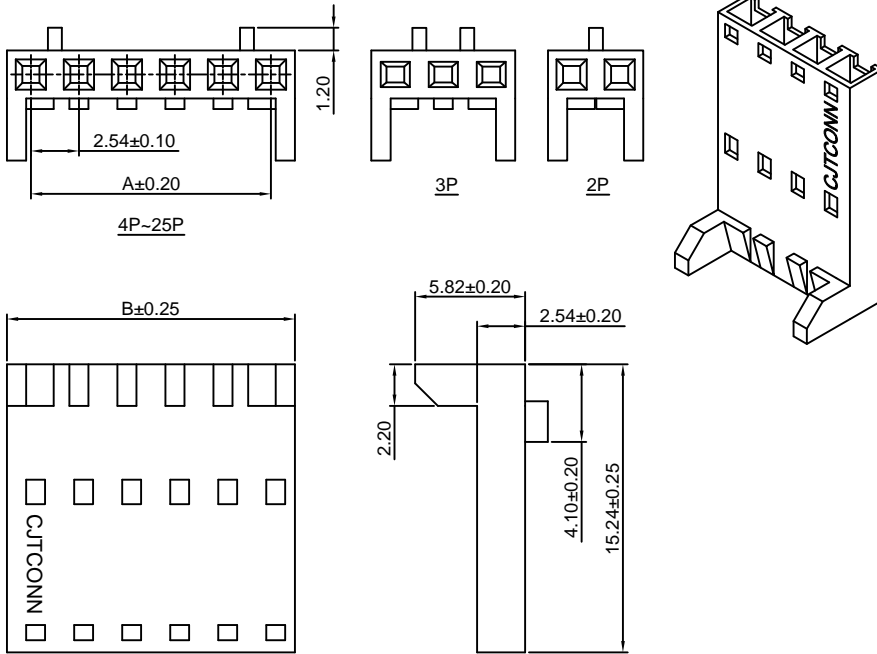

A2547HC(HD)-2P

2.54mm Pitch Housing

Reference Informations:

- *Material: Nylon 66, UL94V-0
- *Suitable CJT A2547-T(-L) A2547-T-C(-L) A2547-T-D series Terminal
- *Mates with CJT A2547HMC-2P A2547HMD-2P Housing and A2547WVC(WRC)-2P, A2547WVD(WRD)-2P Wafer

Ordering Information:

A2547HC(HD)-2P - ***

- | | |
|------------------------------------|---|
| 1 | 2 |
| 1. Part No. | |
| 2. Material: | |
| (Blank): Nylon 66, UL94V-0 | |
| GWT: Nylon 66, UL94V-0, GWT 750 °C | |

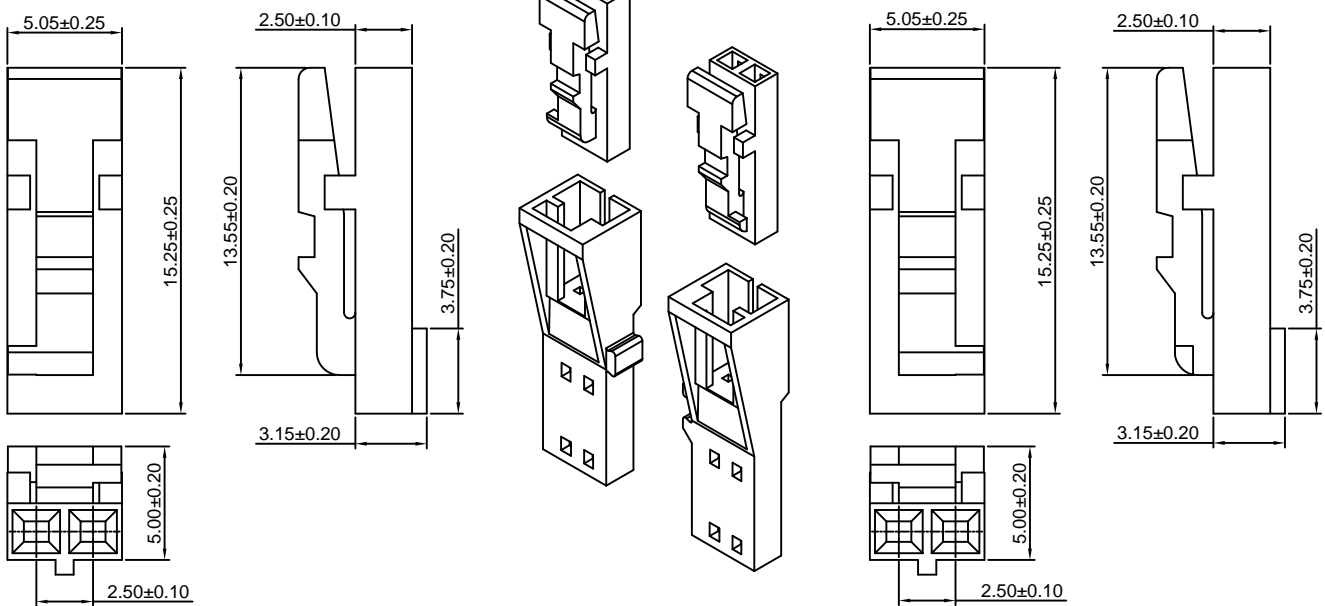

A2547HC-2P(White)

(Mates with CJT A2547HMC-2P Housing)
(Mates with CJT A2547WVC(WRC)-2P Wafer)

A2547HD-2P(Black)

(Mates with CJT A2547HMD-2P Housing)
(Mates with CJT A2547WVD(WRD)-2P Wafer)

Unit: mm

A2547WRC(WRD)-XP

2.54mm Pitch 90° Wafer

Reference Informations:

*Material: Pin: Brass/Gold over Nickel
Insulator: PBT, UL94V-0

*Mates with CJT A2547HC-2P, A2547HD-2P series Housing

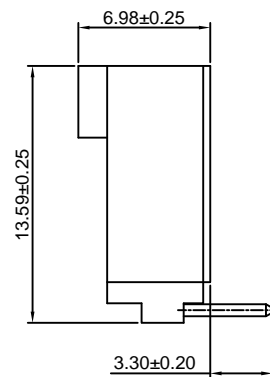
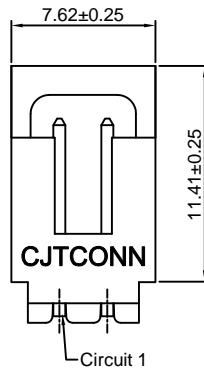
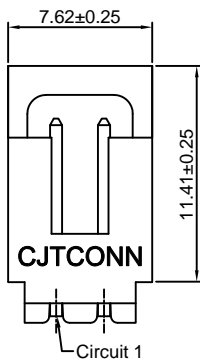
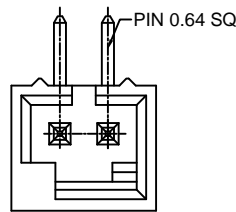
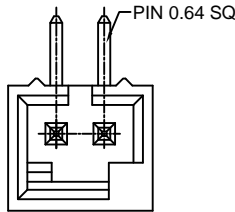

A2547WRC-2P(White)
(Mates with CJT A2547HC-2P Housing)

A2547WRD-2P(Black)
(Mates with CJT A2547HD-2P Housing)

Unit: mm

A2547HM-XP

2.54mm Pitch Housing With Lock

Reference Informations:

*Material: PBT, UL94V-0

*Suitable CJT A2547M-T(-L) series Terminal

*Mates with CJT A2547H, HA-XP, A2547H-XP-3, A2550H-XP-A, A2550H-XP-A1, A2550H-XP-A2, A2550H-XP-A3H, A2550H-XP-H, A2550H-XP-M, A2550H-XP-M2 series Housing

*Color: Black

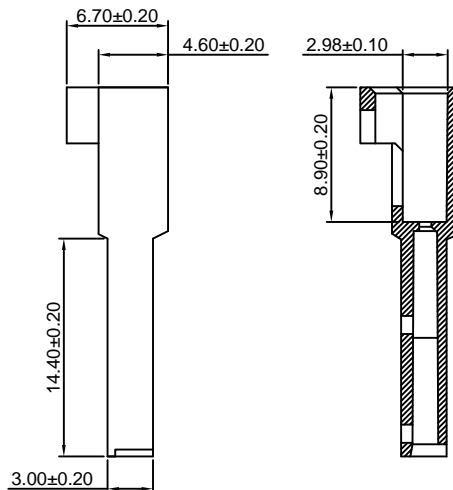
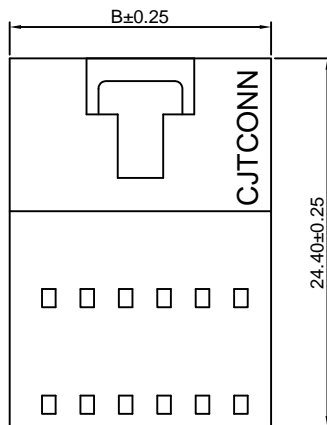
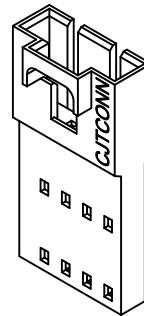
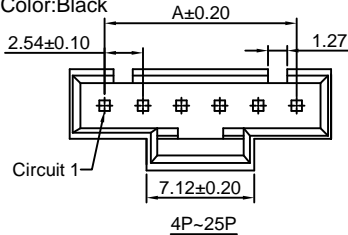

Ordering Information:

A2547HM-XP - ***
1 2

1. Part No.

2. Material:

(Blank): PBT, UL94V-0

GWT: PBT, UL94V-0, GWT 750°C

Ordering Information & Dimensions:

| PART NO. | Dimensions | |
|----------|------------|-------|
| | A | B |
| 2P | 2.54 | 7.12 |
| 3P | 5.08 | 9.66 |
| 4P | 7.62 | 12.20 |
| 5P | 10.16 | 14.74 |
| 6P | 12.70 | 17.28 |
| 7P | 15.24 | 19.82 |
| 8P | 17.78 | 22.36 |
| 9P | 20.32 | 24.90 |
| 10P | 22.86 | 27.44 |
| 11P | 25.40 | 29.98 |
| 12P | 27.94 | 32.52 |
| 13P | 30.48 | 35.06 |
| 14P | 33.02 | 37.60 |
| 15P | 35.56 | 40.14 |
| 16P | 38.10 | 42.68 |
| 17P | 40.64 | 45.22 |
| 18P | 43.18 | 47.76 |
| 19P | 45.72 | 50.30 |
| 20P | 48.26 | 52.84 |
| 21P | 50.80 | 55.38 |
| 22P | 53.34 | 57.92 |
| 23P | 55.88 | 60.46 |
| 24P | 58.42 | 63.00 |
| 25P | 60.96 | 65.54 |

Unit: mm

A2547HMA-XP

2.54mm Pitch Housing With Lock

Reference Informations:

- *Material:PBT,UL94V-0
- *Suitable CJT A2547M-T(-L) series Terminal
- *Mates with CJT A2547H,HA-XP,A2547H-XP-3,A2550H-XP-A,A2550H-XP-A1,A2550H-XP-A2,A2550H-XP-A3H,A2550H-XP-H,A2550H-XP-M,A2550H-XP-M2 series Housing
- *Color:Black

Ordering Information:
A2547HMA-XP - ***
1 2

- 1.Part No.
- 2.Material:
(Blank):PBT,UL94V-0
GWT:PBT,UL94V-0,GWT 750℃

Ordering Information & Dimensions:

| PART NO. | Dimensions | |
|----------|------------|-------|
| | A | B |
| 2P | 2.54 | 7.12 |
| 3P | 5.08 | 9.66 |
| 4P | 7.62 | 12.20 |
| 5P | 10.16 | 14.74 |
| 6P | 12.70 | 17.28 |
| 7P | 15.24 | 19.82 |
| 8P | 17.78 | 22.36 |
| 9P | 20.32 | 24.90 |
| 10P | 22.86 | 27.44 |
| 11P | 25.40 | 29.98 |
| 12P | 27.94 | 32.52 |
| 13P | 30.48 | 35.06 |
| 14P | 33.02 | 37.60 |
| 15P | 35.56 | 40.14 |
| 16P | 38.10 | 42.68 |
| 17P | 40.64 | 45.22 |
| 18P | 43.18 | 47.76 |
| 19P | 45.72 | 50.30 |
| 20P | 48.26 | 52.84 |
| 21P | 50.80 | 55.38 |
| 22P | 53.34 | 57.92 |
| 23P | 55.88 | 60.46 |
| 24P | 58.42 | 63.00 |
| 25P | 60.96 | 65.54 |

Unit: mm



A2547HMB-XP

2.54mm Pitch Housing With Lock

Reference Informations:

- *Material:PBT,UL94V-0
- *Suitable CJT A2547M-T-B series Terminal
- *Mates with CJT A2547H,HA-XP,A2550H-XP series single row Housing
- *Color:Black

Ordering Information:
A2547HMB-XP - ***
1 2

- 1.Part No.
- 2.Material:
(Blank):PBT,UL94V-0
GWT:PBT,UL94V-0,GWT 750℃

Ordering Information & Dimensions:

| PART NO. | Dimensions | |
|----------|------------|-------|
| | A | B |
| 2P | 2.54 | 7.50 |
| 3P | 5.08 | 10.04 |
| 4P | 7.62 | 12.58 |
| 5P | 10.16 | 15.12 |
| 6P | 12.70 | 17.66 |
| 7P | 15.24 | 20.20 |
| 8P | 17.78 | 22.74 |
| 9P | 20.32 | 25.28 |
| 10P | 22.86 | 27.82 |
| 11P | 25.40 | 30.36 |
| 12P | 27.94 | 32.90 |
| 13P | 30.48 | 35.44 |
| 14P | 33.02 | 37.98 |
| 15P | 35.56 | 40.52 |
| 16P | 38.10 | 43.06 |
| 17P | 40.64 | 45.60 |
| 18P | 43.18 | 48.14 |
| 19P | 45.72 | 50.68 |
| 20P | 48.26 | 53.22 |
| 21P | 50.80 | 55.76 |
| 22P | 53.34 | 58.30 |
| 23P | 55.88 | 60.84 |
| 24P | 58.42 | 63.38 |
| 25P | 60.96 | 65.92 |

Unit: mm



A2547HMB-4P-A

2.54mm Pitch Housing With Lock

Reference Informations:

- *Material: PBT, UL94V-0
- *Suitable CJT A2547M-T-B series Terminal
- *Mates with CJT A2550H series single row Housing
- *Color: Black

Ordering Information:
A2547HMB-4P-A - ***
1 2

1. Part No.
2. Material:
(Blank): PBT, UL94V-0
GWT: PBT, UL94V-0, GWT 750 °C



Unit: mm

A2547H-2xXP

2.54mm Pitch Dual Row Housing

Reference Informations:

- *Material: PBT, UL94V-0
- *Suitable CJT A2547-T(-L) A2547-T-C(-L) A2547-T-D series Terminal
- *Mates with CJT A2547WV, WR-2xXP, A2547HI, HIA-2xXP series Wafer
- *Color: Black

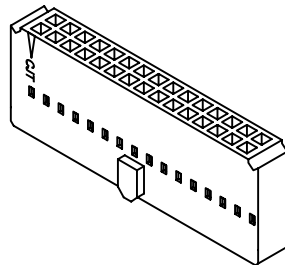

Ordering Information & Dimensions:

| PART NO. | Dimensions | |
|----------|------------|-------|
| | A | B |
| 2x3P | 5.08 | 12.22 |
| 2x4P | 7.62 | 14.76 |
| 2x5P | 10.16 | 17.30 |
| 2x6P | 12.70 | 19.84 |
| 2x7P | 15.24 | 22.38 |
| 2x8P | 17.78 | 24.92 |
| 2x9P | 20.32 | 27.46 |
| 2x10P | 22.86 | 30.00 |
| 2x11P | 25.40 | 32.54 |
| 2x12P | 27.94 | 35.08 |
| 2x13P | 30.48 | 37.62 |
| 2x14P | 33.02 | 40.16 |
| 2x15P | 35.56 | 42.70 |
| 2x16P | 38.10 | 45.24 |
| 2x17P | 40.64 | 47.78 |
| 2x18P | 43.18 | 50.32 |
| 2x19P | 45.72 | 52.86 |
| 2x20P | 48.26 | 55.40 |
| 2x21P | 50.80 | 57.94 |
| 2x22P | 53.34 | 60.48 |
| 2x23P | 55.88 | 63.02 |
| 2x24P | 58.42 | 65.56 |
| 2x25P | 60.96 | 68.10 |
| 2x26P | 63.50 | 70.64 |
| 2x27P | 66.04 | 73.18 |
| 2x28P | 68.58 | 75.72 |
| 2x29P | 71.12 | 78.26 |
| 2x30P | 73.66 | 80.80 |
| 2x31P | 76.20 | 83.34 |
| 2x32P | 78.74 | 85.88 |

Ordering Information:
A2547H-2xXP - ***
1 2

1. Part No.
2. Material:
(Blank): PBT, UL94V-0
GWT: PBT, UL94V-0, GWT 750 °C

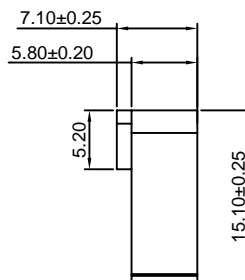
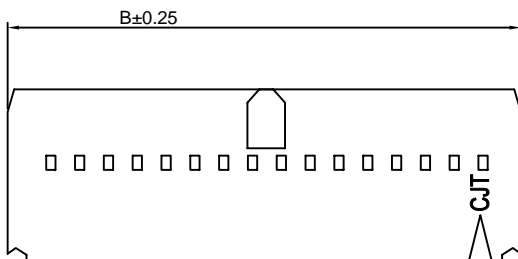

Unit: mm

A2547HA-2xXP

2.54mm Pitch Dual Row Housing

Reference Informations:

- *Material: PBT, UL94V-0
- *Suitable CJT A2547-T(-L) A2547-T-C(-L) A2547-T-D series Terminal
- *Mates with CJT A2547WV, WR, WVC, WRC-2xXP series Wafer
- *Color: Black

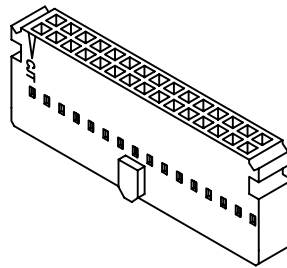
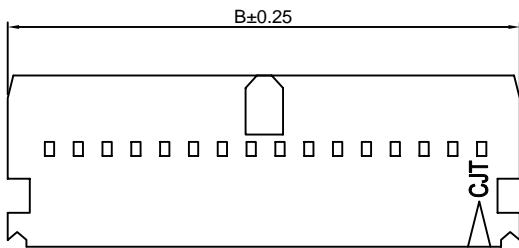
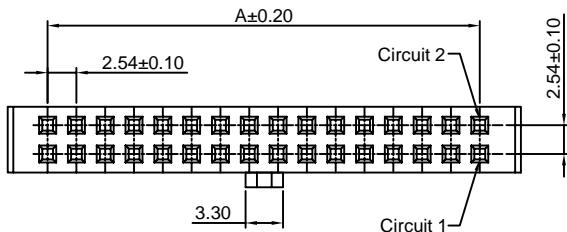

Ordering Information:

- A2547HA-2xXP - ***
- 1
2
- Part No.
 - Material:
(Blank): PBT, UL94V-0
GWT: PBT, UL94V-0, GWT 750°C

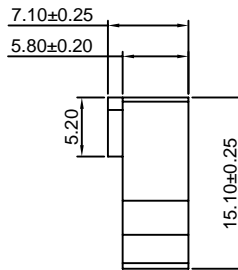

Ordering Information & Dimensions:

| PART NO. | Dimensions | |
|----------|------------|-------|
| | A | B |
| 2x3P | 5.08 | 12.22 |
| 2x4P | 7.62 | 14.76 |
| 2x5P | 10.16 | 17.30 |
| 2x6P | 12.70 | 19.84 |
| 2x7P | 15.24 | 22.38 |
| 2x8P | 17.78 | 24.92 |
| 2x9P | 20.32 | 27.46 |
| 2x10P | 22.86 | 30.00 |
| 2x11P | 25.40 | 32.54 |
| 2x12P | 27.94 | 35.08 |
| 2x13P | 30.48 | 37.62 |
| 2x14P | 33.02 | 40.16 |
| 2x15P | 35.56 | 42.70 |
| 2x16P | 38.10 | 45.24 |
| 2x17P | 40.64 | 47.78 |
| 2x18P | 43.18 | 50.32 |
| 2x19P | 45.72 | 52.86 |
| 2x20P | 48.26 | 55.40 |
| 2x21P | 50.80 | 57.94 |
| 2x22P | 53.34 | 60.48 |
| 2x23P | 55.88 | 63.02 |
| 2x24P | 58.42 | 65.56 |
| 2x25P | 60.96 | 68.10 |
| 2x26P | 63.50 | 70.64 |
| 2x27P | 66.04 | 73.18 |
| 2x28P | 68.58 | 75.72 |
| 2x29P | 71.12 | 78.26 |
| 2x30P | 73.66 | 80.80 |
| 2x31P | 76.20 | 83.34 |
| 2x32P | 78.74 | 85.88 |

Unit: mm

A2547HB-2xXP

2.54mm Pitch Dual Row Housing

Reference Informations:

- *Material: PBT, UL94V-0
- *Suitable CJT A2547-T(-L) A2547-T-C(-L) A2547-T-D series Terminal
- *Mates with CJT A2547WV, WR-2xXP series Wafer
- *Color: Black

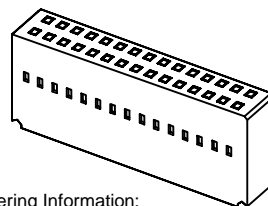
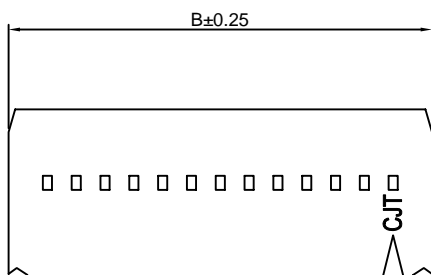
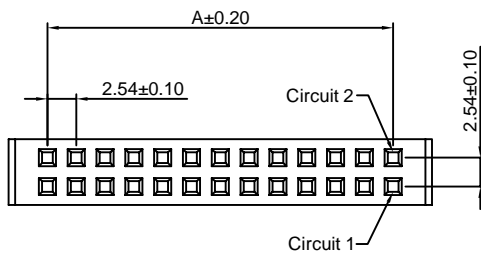

Ordering Information:

- A2547HB-2xXP - ***
- 1
2
- Part No.
 - Material:
(Blank): PBT, UL94V-0
GWT: PBT, UL94V-0, GWT 750°C

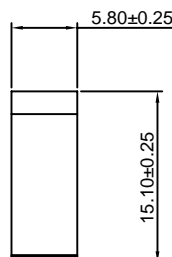

Ordering Information & Dimensions:

| PART NO. | Dimensions | |
|----------|------------|-------|
| | A | B |
| 2x3P | 5.08 | 12.22 |
| 2x4P | 7.62 | 14.76 |
| 2x5P | 10.16 | 17.30 |
| 2x6P | 12.70 | 19.84 |
| 2x7P | 15.24 | 22.38 |
| 2x8P | 17.78 | 24.92 |
| 2x9P | 20.32 | 27.46 |
| 2x10P | 22.86 | 30.00 |
| 2x11P | 25.40 | 32.54 |
| 2x12P | 27.94 | 35.08 |
| 2x13P | 30.48 | 37.62 |
| 2x14P | 33.02 | 40.16 |
| 2x15P | 35.56 | 42.70 |
| 2x16P | 38.10 | 45.24 |
| 2x17P | 40.64 | 47.78 |
| 2x18P | 43.18 | 50.32 |
| 2x19P | 45.72 | 52.86 |
| 2x20P | 48.26 | 55.40 |
| 2x21P | 50.80 | 57.94 |
| 2x22P | 53.34 | 60.48 |
| 2x23P | 55.88 | 63.02 |
| 2x24P | 58.42 | 65.56 |
| 2x25P | 60.96 | 68.10 |
| 2x26P | 63.50 | 70.64 |
| 2x27P | 66.04 | 73.18 |
| 2x28P | 68.58 | 75.72 |
| 2x29P | 71.12 | 78.26 |
| 2x30P | 73.66 | 80.80 |
| 2x31P | 76.20 | 83.34 |
| 2x32P | 78.74 | 85.88 |

Unit: mm

A2547HC-2xXP

2.54mm Pitch Dual Row Housing

Reference Informations:

- *Material:PBT,UL94V-0
- *Suitable CJT A2547-T(-L) A2547-T-C(-L) A2547-T-D series Terminal
- *Mates with CJT A2547WV,WR-2xXP series Wafer
- *Color:Black



Ordering Information:
A2547HC-2xXP - ***
 $\frac{1}{2}$
 1.Part No.
 2.Material:
 (Blank):PBT,UL94V-0
 GWT:PBT,UL94V-0,GWT 750°C

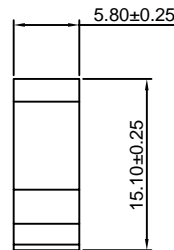
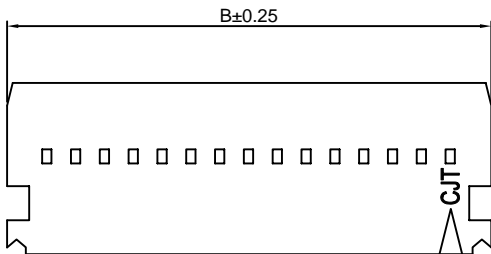

Ordering Information & Dimensions:

| PART NO. | Dimensions | |
|----------|------------|-------|
| | A | B |
| 2x2P | 2.54 | 9.68 |
| 2x3P | 5.08 | 12.22 |
| 2x4P | 7.62 | 14.76 |
| 2x5P | 10.16 | 17.30 |
| 2x6P | 12.70 | 19.84 |
| 2x7P | 15.24 | 22.38 |
| 2x8P | 17.78 | 24.92 |
| 2x9P | 20.32 | 27.46 |
| 2x10P | 22.86 | 30.00 |
| 2x11P | 25.40 | 32.54 |
| 2x12P | 27.94 | 35.08 |
| 2x13P | 30.48 | 37.62 |
| 2x14P | 33.02 | 40.16 |
| 2x15P | 35.56 | 42.70 |
| 2x16P | 38.10 | 45.24 |
| 2x17P | 40.64 | 47.78 |
| 2x18P | 43.18 | 50.32 |
| 2x19P | 45.72 | 52.86 |
| 2x20P | 48.26 | 55.40 |
| 2x21P | 50.80 | 57.94 |
| 2x22P | 53.34 | 60.48 |
| 2x23P | 55.88 | 63.02 |
| 2x24P | 58.42 | 65.56 |
| 2x25P | 60.96 | 68.10 |
| 2x26P | 63.50 | 70.64 |
| 2x27P | 66.04 | 73.18 |
| 2x28P | 68.58 | 75.72 |
| 2x29P | 71.12 | 78.26 |
| 2x30P | 73.66 | 80.80 |
| 2x31P | 76.20 | 83.34 |
| 2x32P | 78.74 | 85.88 |

Unit: mm

A2547HD-2xXP

2.54mm Pitch Dual Row Housing

Reference Informations:

- *Material:PBT,UL94V-0
- *Suitable CJT A2547-T(-L) A2547-T-C(-L) A2547-T-D series Terminal
- *Mates with CJT A2547WVA,WRA-2xXP series Wafer
- *Color:Black

Ordering Information:
A2547HD-2xXP - ***
 $\frac{1}{2}$
 1.Part No.
 2.Material:
 (Blank):PBT,UL94V-0
 GWT:PBT,UL94V-0,GWT 750°C

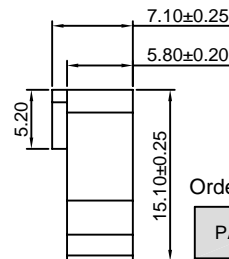
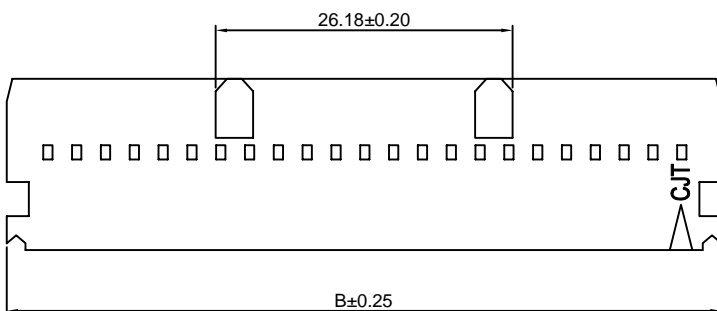
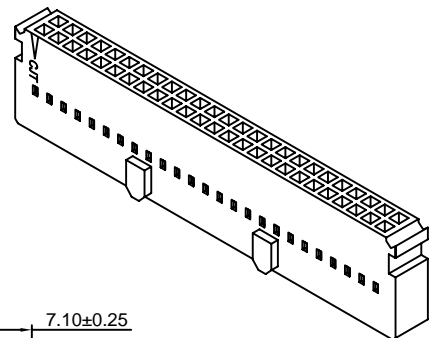
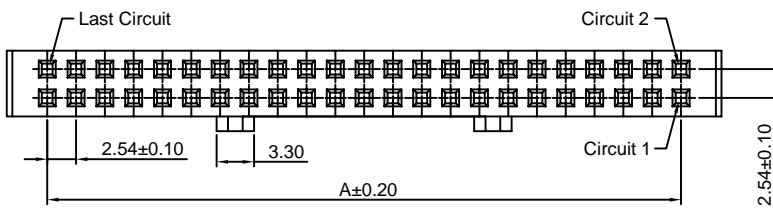

Ordering Information & Dimensions:

| PART NO. | Dimensions | |
|----------|------------|-------|
| | A | B |
| 2x25P | 60.96 | 68.10 |
| 2x30P | 73.66 | 80.80 |
| 2x32P | 78.74 | 85.88 |

Unit: mm

A2547HN-2xXP

2.54mm Pitch Dual Row Housing

Reference Informations:

- *Material:PBT,UL94V-0
- *Suitable CJT A2549-T-C(-H/-L) series Terminal
- *Mates with CJT A2547WV-N,WR-N-2xXP, A2547WV-N-S-2xXP series Wafer
- *Color:Black

Ordering Information:

- A2547HN-2xXP - ***
- | | |
|---|---|
| 1 | 2 |
|---|---|
- 1.Part No.
 - 2.Material:
(Blank):PBT,UL94V-0
GWT:PBT,UL94V-0,GWT 750°C

Ordering Information & Dimensions:

| PART NO. | Dimensions | |
|----------|------------|-------|
| | A | B |
| 2x3P | 5.08 | 12.22 |
| 2x4P | 7.62 | 14.76 |
| 2x5P | 10.16 | 17.30 |
| 2x6P | 12.70 | 19.84 |
| 2x7P | 15.24 | 22.38 |
| 2x8P | 17.78 | 24.92 |
| 2x9P | 20.32 | 27.46 |
| 2x10P | 22.86 | 30.00 |
| 2x11P | 25.40 | 32.54 |
| 2x12P | 27.94 | 35.08 |
| 2x13P | 30.48 | 37.62 |
| 2x14P | 33.02 | 40.16 |
| 2x15P | 35.56 | 42.70 |
| 2x16P | 38.10 | 45.24 |
| 2x17P | 40.64 | 47.78 |
| 2x18P | 43.18 | 50.32 |
| 2x19P | 45.72 | 52.86 |
| 2x20P | 48.26 | 55.40 |
| 2x21P | 50.80 | 57.94 |
| 2x22P | 53.34 | 60.48 |
| 2x23P | 55.88 | 63.02 |
| 2x24P | 58.42 | 65.56 |
| 2x25P | 60.96 | 68.10 |
| 2x26P | 63.50 | 70.64 |
| 2x27P | 66.04 | 73.18 |
| 2x28P | 68.58 | 75.72 |
| 2x29P | 71.12 | 78.26 |
| 2x30P | 73.66 | 80.80 |
| 2x31P | 76.20 | 83.34 |
| 2x32P | 78.74 | 85.88 |

Unit: mm



A2547HF-2xXP

2.54mm Pitch Dual Row Housing

Reference Informations:

- *Material:PBT,UL94V-0
- *Suitable CJT A2547-T(-L) A2547M-T(-L) A2547-T-C(-L) A2547-T-D series Terminal
- *Mates with CJT A2547WV,WR,WVC,WRC-2xXP series Wafer or A2541WV,WR-2xXP series Wafer
- *Color:Black



Ordering Information:

- A2547HF-2xXP - ***
- | | |
|---|---|
| 1 | 2 |
|---|---|
- 1.Part No.
 - 2.Material:
(Blank):PBT,UL94V-0
GWT:PBT,UL94V-0,GWT 750°C

Ordering Information & Dimensions:

| PART NO. | Dimensions | |
|----------|------------|-------|
| | A | B |
| 2x2P | 2.54 | 5.05 |
| 2x3P | 5.08 | 7.59 |
| 2x4P | 7.62 | 10.13 |
| 2x5P | 10.16 | 12.67 |
| 2x6P | 12.70 | 15.21 |
| 2x7P | 15.24 | 17.75 |
| 2x8P | 17.78 | 20.29 |
| 2x9P | 20.32 | 22.83 |
| 2x10P | 22.86 | 25.37 |
| 2x11P | 25.40 | 27.91 |
| 2x12P | 27.94 | 30.45 |
| 2x13P | 30.48 | 32.99 |
| 2x14P | 33.02 | 35.53 |
| 2x15P | 35.56 | 38.07 |
| 2x16P | 38.10 | 40.61 |
| 2x17P | 40.64 | 43.15 |
| 2x18P | 43.18 | 45.69 |
| 2x19P | 45.72 | 48.23 |
| 2x20P | 48.26 | 50.77 |
| 2x21P | 50.80 | 53.31 |
| 2x22P | 53.34 | 55.85 |
| 2x23P | 55.88 | 58.39 |
| 2x24P | 58.42 | 60.93 |
| 2x25P | 60.96 | 63.47 |
| 2x26P | 63.50 | 66.01 |
| 2x27P | 66.04 | 68.55 |
| 2x28P | 68.58 | 71.09 |
| 2x29P | 71.12 | 73.63 |
| 2x30P | 73.66 | 76.17 |
| 2x31P | 76.20 | 78.71 |
| 2x32P | 78.74 | 81.25 |

Unit: mm

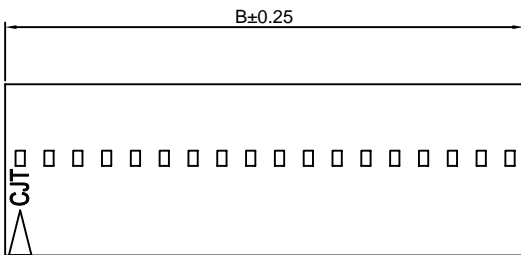
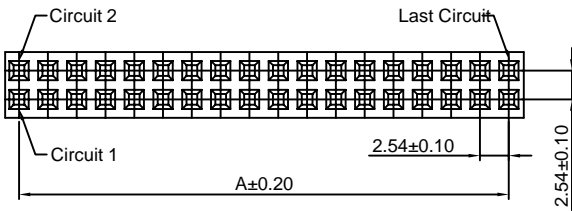

A2547HG-2xXP

2.54mm Pitch Dual Row Housing

Reference Informations:

- *Material:PBT,UL94V-0
- *Suitable CJT A2547-T(-L) A2547-T-C(-L) A2547-T-D series Terminal
- *Mates with CJT A2547WV,WR-2xXP series Wafer
- *Color:Black

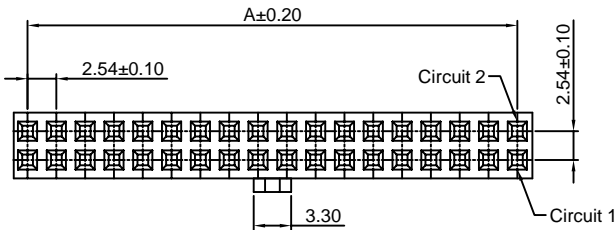

Ordering Information:

- A2547HG-2xXP - ***
- | | |
|---|---|
| 1 | 2 |
|---|---|
- Part No.
 - Material:
(Blank):PBT,UL94V-0
GWT :PBT,UL94V-0 GWT 750 °C

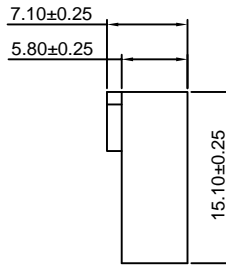
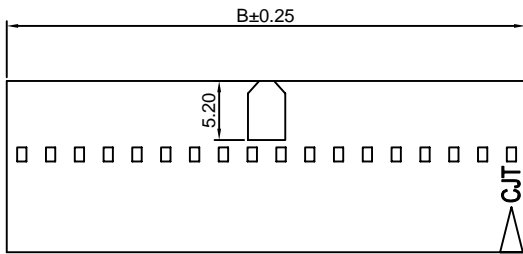

Ordering Information & Dimensions:

| PART NO. | Dimensions | |
|----------|------------|-------|
| | A | B |
| 2x3P | 5.08 | 7.59 |
| 2x4P | 7.62 | 10.13 |
| 2x5P | 10.16 | 12.67 |
| 2x6P | 12.70 | 15.21 |
| 2x7P | 15.24 | 17.75 |
| 2x8P | 17.78 | 20.29 |
| 2x9P | 20.32 | 22.83 |
| 2x10P | 22.86 | 25.37 |
| 2x11P | 25.40 | 27.91 |
| 2x12P | 27.94 | 30.45 |
| 2x13P | 30.48 | 32.99 |
| 2x14P | 33.02 | 35.53 |
| 2x15P | 35.56 | 38.07 |
| 2x16P | 38.10 | 40.61 |
| 2x17P | 40.64 | 43.15 |
| 2x18P | 43.18 | 45.69 |
| 2x19P | 45.72 | 48.23 |
| 2x20P | 48.26 | 50.77 |
| 2x21P | 50.80 | 53.31 |
| 2x22P | 53.34 | 55.85 |
| 2x23P | 55.88 | 58.39 |
| 2x24P | 58.42 | 60.93 |
| 2x25P | 60.96 | 63.47 |
| 2x26P | 63.50 | 66.01 |
| 2x27P | 66.04 | 68.55 |
| 2x28P | 68.58 | 71.09 |
| 2x29P | 71.12 | 73.63 |
| 2x30P | 73.66 | 76.17 |
| 2x31P | 76.20 | 78.71 |
| 2x32P | 78.74 | 81.25 |

Unit: mm

A2547HJ-2xXP

2.54mm Pitch Dual Row Housing

Reference Informations:

- *Material:PBT,UL94V-0
- *Suitable CJT A2547-T(-L) A2547-T-C(-L) A2547-T-D series Terminal
- *Mates with CJT A2547WVB,WRB-2xXP(-A) A2547WVB-S-2xXP(-A) series Dual row Wafer
- *Color:Black

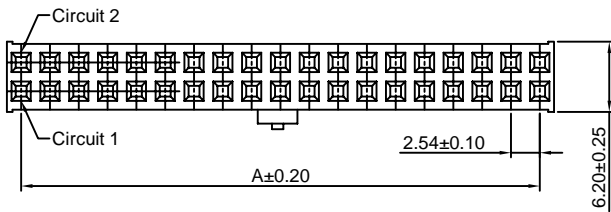

Ordering Information:

- A2547HJ-2xXP - ***
- | | |
|---|---|
| 1 | 2 |
|---|---|
- Part No.
 - Material:
(Blank):PBT,UL94V-0
GWT:PBT,UL94V-0 GWT 750 °C

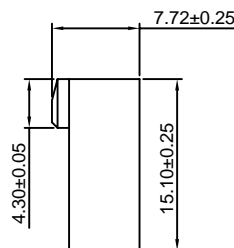
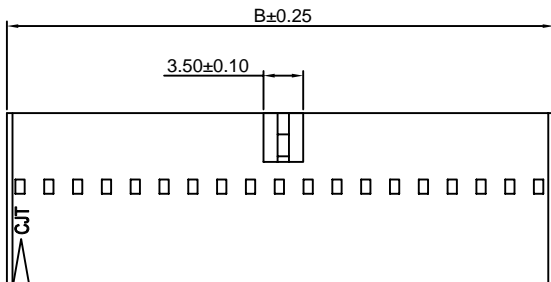

Ordering Information & Dimensions:

| PART NO. | Dimensions | |
|----------|------------|-------|
| | A | B |
| 2x3P | 5.08 | 7.59 |
| 2x4P | 7.62 | 10.13 |
| 2x5P | 10.16 | 12.67 |
| 2x6P | 12.70 | 15.21 |
| 2x7P | 15.24 | 17.75 |
| 2x8P | 17.78 | 20.29 |
| 2x9P | 20.32 | 22.83 |
| 2x10P | 22.86 | 25.37 |
| 2x11P | 25.40 | 27.91 |
| 2x12P | 27.94 | 30.45 |
| 2x13P | 30.48 | 32.99 |
| 2x14P | 33.02 | 35.53 |
| 2x15P | 35.56 | 38.07 |
| 2x16P | 38.10 | 40.61 |
| 2x17P | 40.64 | 43.15 |
| 2x18P | 43.18 | 45.69 |
| 2x19P | 45.72 | 48.23 |
| 2x20P | 48.26 | 50.77 |
| 2x21P | 50.80 | 53.31 |
| 2x22P | 53.34 | 55.85 |
| 2x23P | 55.88 | 58.39 |
| 2x24P | 58.42 | 60.93 |
| 2x25P | 60.96 | 63.47 |
| 2x26P | 63.50 | 66.01 |
| 2x27P | 66.04 | 68.55 |
| 2x28P | 68.58 | 71.09 |
| 2x29P | 71.12 | 73.63 |
| 2x30P | 73.66 | 76.17 |
| 2x31P | 76.20 | 78.71 |
| 2x32P | 78.74 | 81.25 |

Unit: mm

A2547HJ-XP

2.54mm Pitch Single Row Housing

Reference Informations:

- *Material:PBT,UL94V-0
- *Suitable CJT A2547-T(-L) A2547-T-C(-L) A2547-T-D series Terminal
- *Mates with CJT A2547WVB,WRB-XP series Single Row Wafer
- *Color:Black

Ordering Information:

- A2547HJ-XP - ***
 $\frac{1}{2}$
 1.Part No.
 2.Material:
 (Blank):PBT,UL94V-0
 GWT:PBT,UL94V-0,GWT 750 °C



Ordering Information & Dimensions:

| PART NO. | Dimensions | |
|----------|------------|-------|
| | A | B |
| 2P | 2.54 | 6.14 |
| 3P | 5.08 | 8.68 |
| 4P | 7.62 | 11.22 |
| 5P | 10.16 | 13.76 |
| 6P | 12.70 | 16.30 |
| 7P | 15.24 | 18.84 |
| 8P | 17.78 | 21.38 |
| 9P | 20.32 | 23.92 |
| 10P | 22.86 | 26.46 |
| 11P | 25.40 | 29.00 |
| 12P | 27.94 | 31.54 |
| 13P | 30.48 | 34.08 |
| 14P | 33.02 | 36.62 |
| 15P | 35.56 | 39.16 |
| 16P | 38.10 | 41.70 |
| 17P | 40.64 | 44.24 |
| 18P | 43.18 | 46.78 |
| 19P | 45.72 | 49.32 |
| 20P | 48.26 | 51.86 |
| 21P | 50.80 | 54.40 |
| 22P | 53.34 | 56.94 |
| 23P | 55.88 | 59.48 |
| 24P | 58.42 | 62.02 |
| 25P | 60.96 | 64.56 |
| 26P | 63.50 | 67.10 |
| 27P | 66.04 | 69.64 |
| 28P | 68.58 | 72.18 |
| 29P | 71.12 | 74.72 |
| 30P | 73.66 | 77.26 |
| 31P | 76.20 | 79.80 |
| 32P | 78.74 | 82.34 |

Unit: mm

A2547HK-2xXP

2.54mm Pitch Dual Row Housing

Reference Informations:

- *Material: PBT,UL94V-0
- *Suitable CJT A2547-T(-L) A2547-T-C(-L) A2547-T-D series Terminal
- *Mates with CJT A2547WV,WR-2xXP-L series Dual row Wafer
- *Color:Black

Ordering Information:

- A2547HK-2xXP - ***
 $\frac{1}{2}$
 1.Part No.
 2.Material:
 (Blank):PBT,UL94V-0
 GWT:PBT,UL94V-0,GWT 750 °C

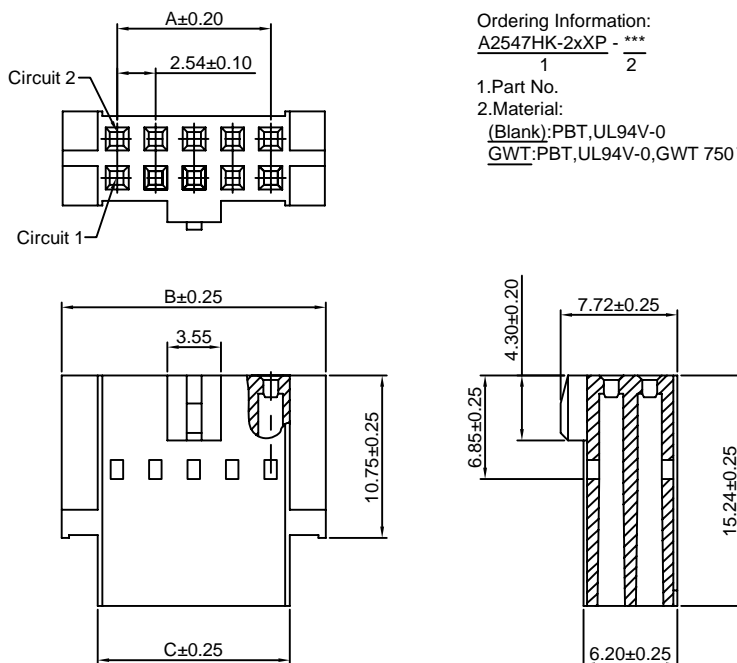

Ordering Information & Dimensions:

| PART NO. | Dimensions | | |
|----------|------------|-------|-------|
| | A | B | C |
| 2x4P | 7.62 | 14.93 | 10.16 |
| 2x5P | 10.16 | 17.47 | 12.70 |
| 2x6P | 12.70 | 20.01 | 15.24 |
| 2x7P | 15.24 | 22.55 | 17.78 |
| 2x8P | 17.78 | 25.09 | 20.32 |
| 2x9P | 20.32 | 27.63 | 22.86 |
| 2x10P | 22.86 | 30.17 | 25.40 |
| 2x11P | 25.40 | 32.71 | 27.94 |
| 2x12P | 27.94 | 35.25 | 30.48 |
| 2x13P | 30.48 | 37.79 | 33.02 |
| 2x14P | 33.02 | 40.33 | 35.56 |
| 2x15P | 35.56 | 42.87 | 38.10 |
| 2x16P | 38.10 | 45.41 | 40.64 |
| 2x17P | 40.64 | 47.95 | 43.18 |
| 2x18P | 43.18 | 50.49 | 45.72 |
| 2x19P | 45.72 | 53.03 | 48.26 |
| 2x20P | 48.26 | 55.57 | 50.80 |
| 2x21P | 50.80 | 58.11 | 53.34 |
| 2x22P | 53.34 | 60.65 | 55.88 |
| 2x23P | 55.88 | 63.19 | 58.42 |
| 2x24P | 58.42 | 65.73 | 60.96 |
| 2x25P | 60.96 | 68.27 | 63.50 |
| 2x26P | 63.50 | 70.81 | 66.04 |
| 2x27P | 66.04 | 73.35 | 68.58 |
| 2x28P | 68.58 | 75.89 | 71.12 |
| 2x29P | 71.12 | 78.43 | 73.66 |
| 2x30P | 73.66 | 80.97 | 76.20 |
| 2x31P | 76.20 | 83.51 | 78.74 |
| 2x32P | 78.74 | 86.05 | 81.28 |

Unit: mm

A2547HL-2xXP

2.54mm Pitch Dual Row Housing

Reference Informations:

- *Material: PBT,UL94V-0
- *Suitable CJT A2547 series Terminal
- *Mates with CJT A2547 series Wafer
- *Color:Black

Ordering Information:

- A2547HL-2xXP - ***
 1 2
 1.Part No.
 2.Material:
 (Blank):PBT,UL94V-0
 GWT:PBT,UL94V-0 GWT 750 °C

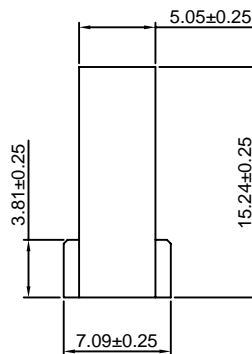
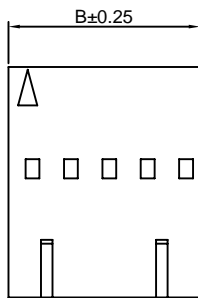
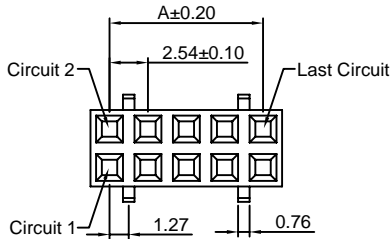

Ordering Information & Dimensions:

| PART NO. | Dimensions | |
|----------|------------|-------|
| | A | B |
| 2x2P | 2.54 | 5.05 |
| 2x3P | 5.08 | 7.59 |
| 2x4P | 7.62 | 10.13 |
| 2x5P | 10.16 | 12.67 |
| 2x6P | 12.70 | 15.21 |
| 2x7P | 15.24 | 17.75 |
| 2x8P | 17.78 | 20.29 |
| 2x9P | 20.32 | 22.83 |
| 2x10P | 22.86 | 25.37 |
| 2x11P | 25.40 | 27.91 |
| 2x12P | 27.94 | 30.45 |
| 2x13P | 30.48 | 32.99 |
| 2x14P | 33.02 | 35.53 |
| 2x15P | 35.56 | 38.07 |
| 2x16P | 38.10 | 40.61 |
| 2x17P | 40.64 | 43.15 |
| 2x18P | 43.18 | 45.69 |
| 2x19P | 45.72 | 48.23 |
| 2x20P | 48.26 | 50.77 |
| 2x21P | 50.80 | 53.31 |
| 2x22P | 53.34 | 55.85 |
| 2x23P | 55.88 | 58.39 |
| 2x24P | 58.42 | 60.93 |
| 2x25P | 60.96 | 63.47 |
| 2x26P | 63.50 | 66.01 |
| 2x27P | 66.04 | 68.55 |
| 2x28P | 68.58 | 71.09 |
| 2x29P | 71.12 | 73.63 |
| 2x30P | 73.66 | 76.17 |
| 2x31P | 76.20 | 78.71 |
| 2x32P | 78.74 | 81.25 |

Unit: mm

A2547HP-2xXP

2.54mm Pitch Dual Row Housing

Reference Informations:

- *Material: PBT,UL94V-0
- *Suitable CJT A2547 series Terminal
- *Mates with CJT A2547 series Wafer
- *Color:Black

Ordering Information:

- A2547HP-2xXP - ***
 1 2
 1.Part No.
 2.Material:
 (Blank):PBT,UL94V-0
 GWT:PBT,UL94V-0 GWT 750 °C

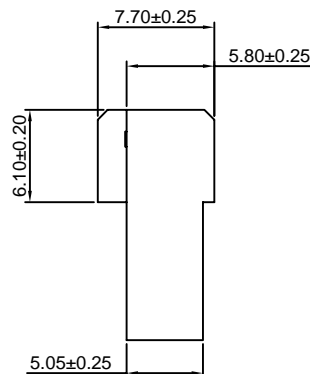
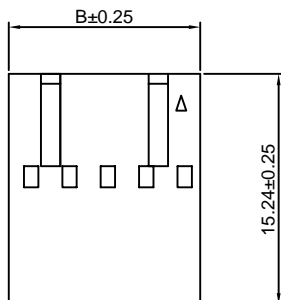
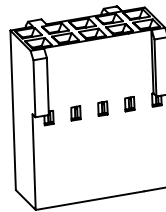
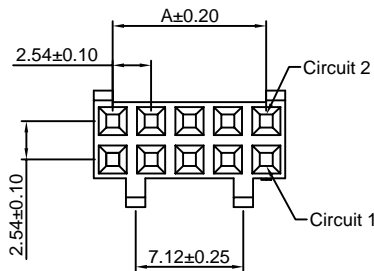

Ordering Information & Dimensions:

| PART NO. | Dimensions | |
|----------|------------|-------|
| | A | B |
| 2x2P | 2.54 | 5.05 |
| 2x3P | 5.08 | 7.59 |
| 2x4P | 7.62 | 10.13 |
| 2x5P | 10.16 | 12.67 |
| 2x6P | 12.70 | 15.21 |
| 2x7P | 15.24 | 17.75 |
| 2x8P | 17.78 | 20.29 |
| 2x9P | 20.32 | 22.83 |
| 2x10P | 22.86 | 25.37 |
| 2x11P | 25.40 | 27.91 |
| 2x12P | 27.94 | 30.45 |
| 2x13P | 30.48 | 32.99 |
| 2x14P | 33.02 | 35.53 |
| 2x15P | 35.56 | 38.07 |
| 2x16P | 38.10 | 40.61 |
| 2x17P | 40.64 | 43.15 |
| 2x18P | 43.18 | 45.69 |
| 2x19P | 45.72 | 48.23 |
| 2x20P | 48.26 | 50.77 |
| 2x21P | 50.80 | 53.31 |
| 2x22P | 53.34 | 55.85 |
| 2x23P | 55.88 | 58.39 |
| 2x24P | 58.42 | 60.93 |
| 2x25P | 60.96 | 63.47 |
| 2x26P | 63.50 | 66.01 |
| 2x27P | 66.04 | 68.55 |
| 2x28P | 68.58 | 71.09 |
| 2x29P | 71.12 | 73.63 |
| 2x30P | 73.66 | 76.17 |
| 2x31P | 76.20 | 78.71 |
| 2x32P | 78.74 | 81.25 |

Unit: mm

A2547HS-2xXP

2.54mm Pitch Dual Row Housing

Reference Informations:

- *Material:PBT,UL94V-0
- *Suitable CJT A2547-T(-L) A2547-T-C(-L) A2547-T-D series Terminal
- *Mates with CJT A2547WV,WR,WVC,WRC-2xXP series Wafer
- *Color:Black

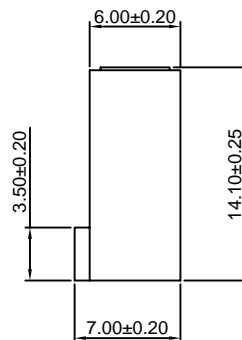
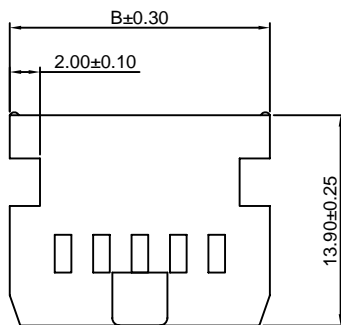
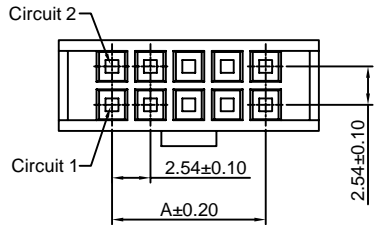
Ordering Information:

- A2547HS-2xXP - ***
 1 2
 1.Part No.
 2.Material:
 (Blank):PBT,UL94V-0
 GWT:PBT,UL94V-0,GWT 750°C

Ordering Information & Dimensions:

| PART NO. | Dimensions | |
|----------|------------|-------|
| | A | B |
| 2x5P | 10.16 | 17.25 |
| 2x6P | 12.70 | 19.79 |
| 2x7P | 15.24 | 22.33 |
| 2x8P | 17.78 | 24.87 |
| 2x9P | 20.32 | 27.41 |
| 2x10P | 22.86 | 29.95 |
| 2x11P | 25.40 | 32.49 |
| 2x12P | 27.94 | 35.03 |
| 2x13P | 30.48 | 37.57 |
| 2x14P | 33.02 | 40.11 |
| 2x15P | 35.56 | 42.65 |
| 2x16P | 38.10 | 45.19 |
| 2x17P | 40.64 | 47.73 |
| 2x18P | 43.18 | 50.27 |
| 2x19P | 45.72 | 52.81 |
| 2x20P | 48.26 | 55.35 |
| 2x21P | 50.80 | 57.89 |
| 2x22P | 53.34 | 60.43 |
| 2x23P | 55.88 | 62.97 |
| 2x24P | 58.42 | 65.51 |
| 2x25P | 60.96 | 68.05 |
| 2x26P | 63.50 | 70.59 |
| 2x27P | 66.04 | 73.13 |
| 2x28P | 68.58 | 75.67 |
| 2x29P | 71.12 | 78.21 |
| 2x30P | 73.66 | 80.75 |
| 2x31P | 76.20 | 83.29 |
| 2x32P | 78.74 | 85.83 |

Unit: mm

A2547HSA-2xXP

2.54mm Pitch Dual Row Housing

Reference Informations:

- *Material:PBT,UL94V-0
- *Suitable CJT A2547-T(-L) A2547-T-C(-L) A2547-T-D series Terminal
- *Mates with CJT A2547WVA,WRA-2xXP series Wafer
- *Color:Black

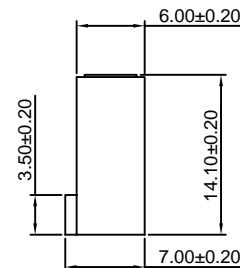
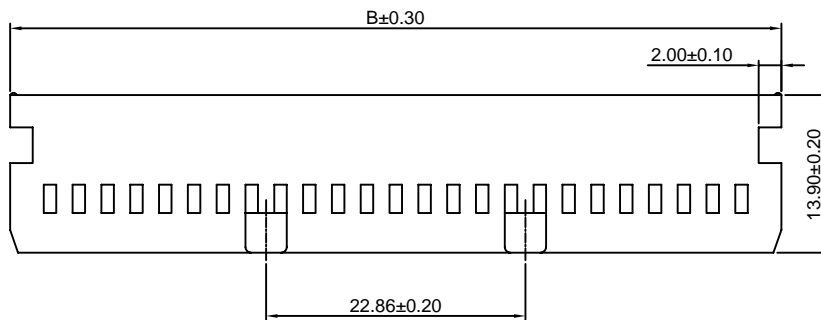
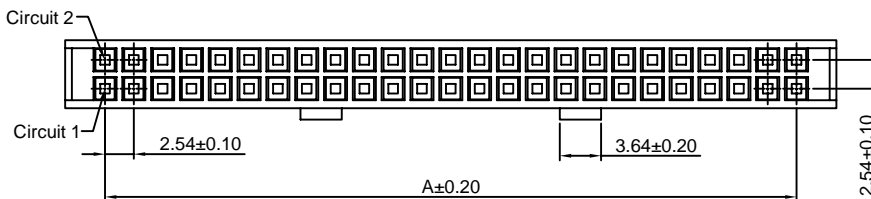
Ordering Information:

- A2547HSA-2xXP - ***
 1 2
 1.Part No.
 2.Material:
 (Blank):PBT,UL94V-0
 GWT:PBT,UL94V-0,GWT 750°C

Ordering Information & Dimensions:

| PART NO. | Dimensions | |
|----------|------------|-------|
| | A | B |
| 2x25P | 60.96 | 68.05 |
| 2x30P | 73.66 | 80.75 |
| 2x32P | 78.74 | 85.83 |

Unit: mm

A2547WV-XP

2.54mm Pitch 180° Wafer

Reference Informations:

- *Material: Pin: Brass/Gold over Nickel
Insulator: PBT, UL94V-0
- *Mates with CJT A2547H-XP(-2,-3), A2547HA, HB-XP, A2550H-XP-(A,A1,A2,A3H,B,H,G,M,M1,M2), A2541H-XP series Housing
- *Color: Black

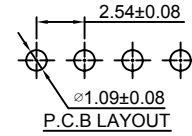
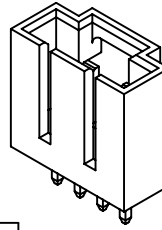

Ordering Information & Dimensions:

| PART NO. | Dimensions | |
|----------|------------|-------|
| | A | B |
| 2P | 2.54 | 7.62 |
| 3P | 5.08 | 10.16 |
| 4P | 7.62 | 12.70 |
| 5P | 10.16 | 15.24 |
| 6P | 12.70 | 17.78 |
| 7P | 15.24 | 20.32 |
| 8P | 17.78 | 22.86 |
| 9P | 20.32 | 25.40 |
| 10P | 22.86 | 27.94 |
| 11P | 25.40 | 30.48 |
| 12P | 27.94 | 33.02 |
| 13P | 30.48 | 35.56 |
| 14P | 33.02 | 38.10 |
| 15P | 35.56 | 40.64 |
| 16P | 38.10 | 43.18 |
| 17P | 40.64 | 45.72 |
| 18P | 43.18 | 48.26 |
| 19P | 45.72 | 50.80 |
| 20P | 48.26 | 53.34 |
| 21P | 50.80 | 55.88 |
| 22P | 53.34 | 58.42 |
| 23P | 55.88 | 60.96 |
| 24P | 58.42 | 63.50 |
| 25P | 60.96 | 66.04 |

Unit: mm

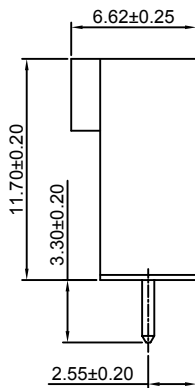
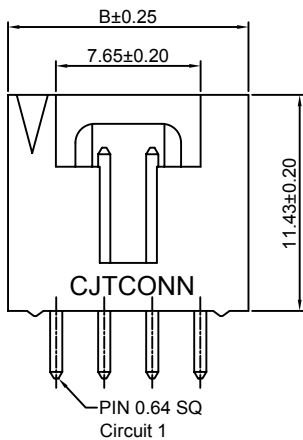
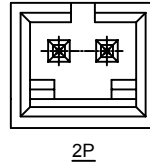
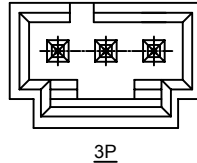
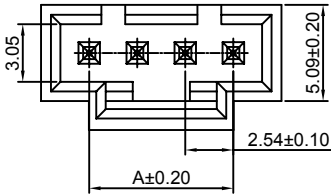

Ordering Information:
A2547WV-XP - *** - ***

1. Part No.
2. Material:
(Blank): PBT, UL94V-0
6T: Nylon 6T, UL94V-0
GWT: PBT, UL94V-0, GWT 750°C
3. Finish:
(blank): Gold-flash
G15: 15µin (0.38µm) MIN. Select Gold (Mating Area)
100µin (2.54µm) MIN. Select Tin
G30: 30µin (0.76µm) MIN. Select Gold (Mating Area)
100µin (2.54µm) MIN. Select Tin
T: Tin over Nickel

A2547WR-XP

2.54mm Pitch 90° Wafer

Reference Informations:

- *Material: Pin: Brass/Gold over Nickel
Insulator: PBT, UL94V-0
- *Mates with CJT A2547H-XP(-2,-3), A2547HA, HB-XP, A2550H-XP-(A,A1,A2,A3H,B,H,G,M,M1,M2), A2541H-XP series Housing
- *Color: Black

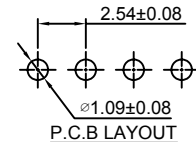
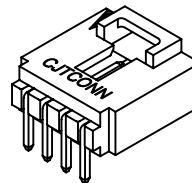

Ordering Information & Dimensions:

| PART NO. | Dimensions | |
|----------|------------|-------|
| | A | B |
| 2P | 2.54 | 7.62 |
| 3P | 5.08 | 10.16 |
| 4P | 7.62 | 12.70 |
| 5P | 10.16 | 15.24 |
| 6P | 12.70 | 17.78 |
| 7P | 15.24 | 20.32 |
| 8P | 17.78 | 22.86 |
| 9P | 20.32 | 25.40 |
| 10P | 22.86 | 27.94 |
| 11P | 25.40 | 30.48 |
| 12P | 27.94 | 33.02 |
| 13P | 30.48 | 35.56 |
| 14P | 33.02 | 38.10 |
| 15P | 35.56 | 40.64 |
| 16P | 38.10 | 43.18 |
| 17P | 40.64 | 45.72 |
| 18P | 43.18 | 48.26 |
| 19P | 45.72 | 50.80 |
| 20P | 48.26 | 53.34 |
| 21P | 50.80 | 55.88 |
| 22P | 53.34 | 58.42 |
| 23P | 55.88 | 60.96 |
| 24P | 58.42 | 63.50 |
| 25P | 60.96 | 66.04 |

Unit: mm

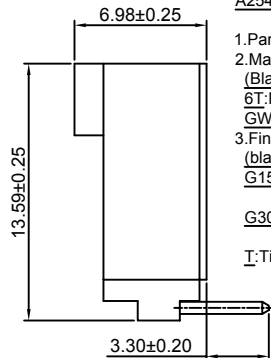
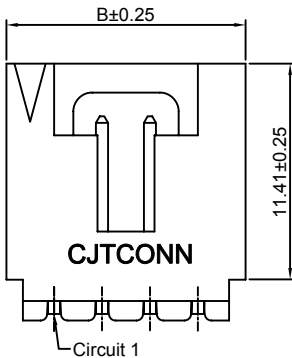
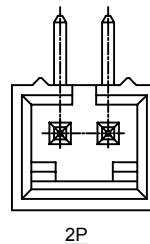
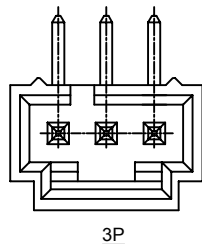
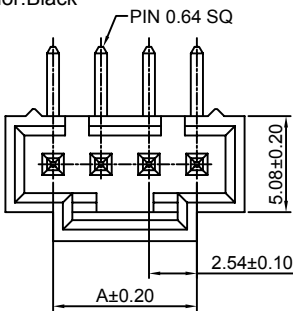

Ordering Information:
A2547WR-XP - *** - ***

1. Part No.
2. Material:
(Blank): PBT, UL94V-0
6T: Nylon 6T, UL94V-0
GWT: PBT, UL94V-0, GWT 750°C
3. Finish:
(blank): Gold-flash
G15: 15µin (0.38µm) MIN. Select Gold (Mating Area)
100µin (2.54µm) MIN. Select Tin
G30: 30µin (0.76µm) MIN. Select Gold (Mating Area)
100µin (2.54µm) MIN. Select Tin
T: Tin over Nickel

A2547WR-XP-2

2.54mm Pitch 90° Wafer

Reference Informations:

- *Material: Pin: Brass/Gold over Nickel
Insulator: PBT, UL94V-0
- *Mates with CJT A2547H-XP(-2,-3), A2547HA, HB-XP, A2550H-XP-(A,A1,A2,A3H,B,H,G,M,M1,M2), A2541H-XP series Housing
- *Color: Black

Ordering Information:

A2547WR-XP-2 - *** - ***
1 2 3

- Part No.
- Material:
(Blank): PBT, UL94V-0
6T: Nylon 6T, UL94V-0
GWT: PBT, UL94V-0, GWT 750°C
- Finish:
(blank): Gold-flash
G15: 15µm (0.38µm) MIN. Select Gold (Mating Area)
100µm (2.54µm) MIN. Select Tin
G30: 30µm (0.76µm) MIN. Select Gold (Mating Area)
100µm (2.54µm) MIN. Select Tin
T: Tin over Nickel

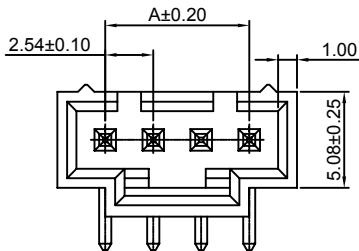

4P-25P

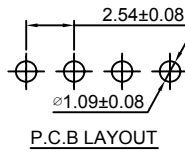

P.C.B LAYOUT

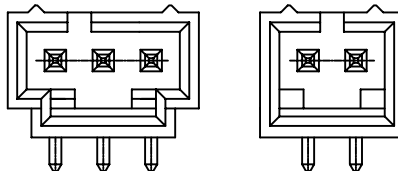

3P

2P

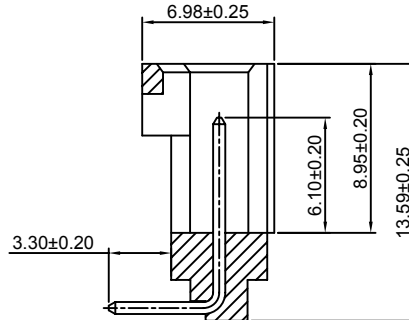
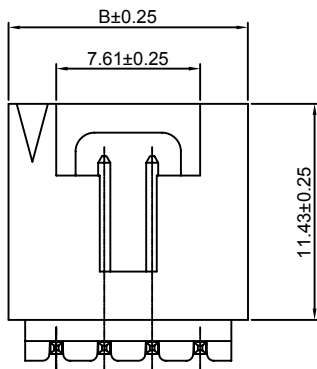

Ordering Information & Dimensions:

| PART NO. | Dimensions | |
|----------|------------|-------|
| | A | B |
| 2P | 2.54 | 7.62 |
| 3P | 5.08 | 10.16 |
| 4P | 7.62 | 12.70 |
| 5P | 10.16 | 15.24 |
| 6P | 12.70 | 17.78 |
| 7P | 15.24 | 20.32 |
| 8P | 17.78 | 22.86 |
| 9P | 20.32 | 25.40 |
| 10P | 22.86 | 27.94 |
| 11P | 25.40 | 30.48 |
| 12P | 27.94 | 33.02 |
| 13P | 30.48 | 35.56 |
| 14P | 33.02 | 38.10 |
| 15P | 35.56 | 40.64 |

Unit: mm

A2547WV-S-XP

2.54mm Pitch 180° Wafer - SMT TYPE

Reference Informations:

- *Material: Pin: Brass/Gold over Nickel
Insulator: LCP, UL94V-0
- *Mates with CJT A2547H-XP(-2,-3), A2547HA, HB-XP, A2550H-XP-(A,A1,A2,A3H,B,H,G,M,M1,M2), A2541H-XP series Housing
- *Color: Black

Ordering Information:

A2547WV-S-XP - *** - ***
1 2 3

- Part No.
- Material:
(Blank): LCP, UL94V-0
6T: Nylon 6T, UL94V-0
GWT: LCP, UL94V-0, GWT 750°C
- Finish:
(blank): Gold-flash
G15: 15µm (0.38µm) MIN. Select Gold (Mating Area)
100µm (2.54µm) MIN. Select Tin
G30: 30µm (0.76µm) MIN. Select Gold (Mating Area)
100µm (2.54µm) MIN. Select Tin
T: Tin over Nickel

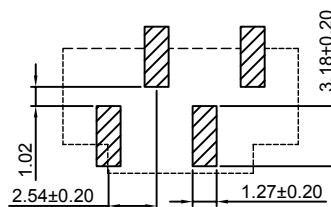

P.C.B LAYOUT

Ordering Information & Dimensions:

| PART NO. | Dimensions | |
|----------|------------|-------|
| | A | B |
| 3P | 5.08 | 10.16 |
| 4P | 7.62 | 12.70 |
| 5P | 10.16 | 15.24 |
| 6P | 12.70 | 17.78 |
| 7P | 15.24 | 20.32 |
| 8P | 17.78 | 22.86 |
| 9P | 20.32 | 25.40 |
| 10P | 22.86 | 27.94 |
| 11P | 25.40 | 30.48 |
| 12P | 27.94 | 33.02 |
| 13P | 30.48 | 35.56 |
| 14P | 33.02 | 38.10 |
| 15P | 35.56 | 40.64 |
| 16P | 38.10 | 43.18 |
| 17P | 40.64 | 45.72 |
| 18P | 43.18 | 48.26 |
| 19P | 45.72 | 50.80 |
| 20P | 48.26 | 53.34 |
| 21P | 50.80 | 55.88 |
| 22P | 53.34 | 58.42 |
| 23P | 55.88 | 60.96 |
| 24P | 58.42 | 63.50 |
| 25P | 60.96 | 66.04 |

Unit: mm

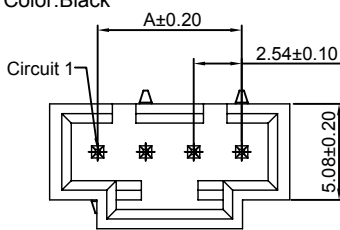

4P~25P

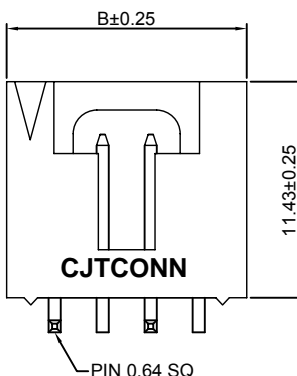

CJTCONN

PIN 0.64 SQ

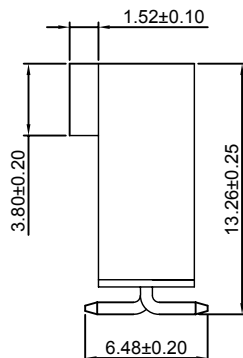

3P

A2547WR-F-XP

2.54mm Pitch 90° Wafer With Peg

Reference Informations:

- *Material: Pin: Brass/Gold over Nickel
Insulator: PBT, UL94V-0
- *Mates with CJT A2547H-XP(-2,-3), A2547HA, HB-XP, A2550H-XP-(A,A1,A2,A3H,B,H,G,M,M1,M2), A2541H-XP series Housing
- *Color: Black

Ordering Information:

A2547WR-F-XP - *** - ***
1 2 3

- Part No.
- Material:
(Blank): PBT, UL94V-0
6T: Nylon 6T, UL94V-0
GWT: PBT, UL94V-0, GWT 750°C
- Finish:
(blank): Gold-flash
G15: 15µin (0.38µm) MIN. Select Gold (Mating Area)
100µin (2.54µm) MIN. Select Tin
G30: 30µin (0.76µm) MIN. Select Gold (Mating Area)
100µin (2.54µm) MIN. Select Tin
T: Tin over Nickel

Ordering Information & Dimensions:

| PART NO. | Dimensions | |
|----------|------------|-------|
| | A | B |
| 2P | 2.54 | 7.62 |
| 3P | 5.08 | 10.16 |
| 4P | 7.62 | 12.70 |
| 5P | 10.16 | 15.24 |
| 6P | 12.70 | 17.78 |
| 7P | 15.24 | 20.32 |
| 8P | 17.78 | 22.86 |
| 9P | 20.32 | 25.40 |
| 10P | 22.86 | 27.94 |
| 11P | 25.40 | 30.48 |
| 12P | 27.94 | 33.02 |
| 13P | 30.48 | 35.56 |
| 14P | 33.02 | 38.10 |
| 15P | 35.56 | 40.64 |
| 16P | 38.10 | 43.18 |
| 17P | 40.64 | 45.72 |
| 18P | 43.18 | 48.26 |
| 19P | 45.72 | 50.80 |
| 20P | 48.26 | 53.34 |
| 21P | 50.80 | 55.88 |
| 22P | 53.34 | 58.42 |
| 23P | 55.88 | 60.96 |
| 24P | 58.42 | 63.50 |
| 25P | 60.96 | 66.04 |

Unit: mm

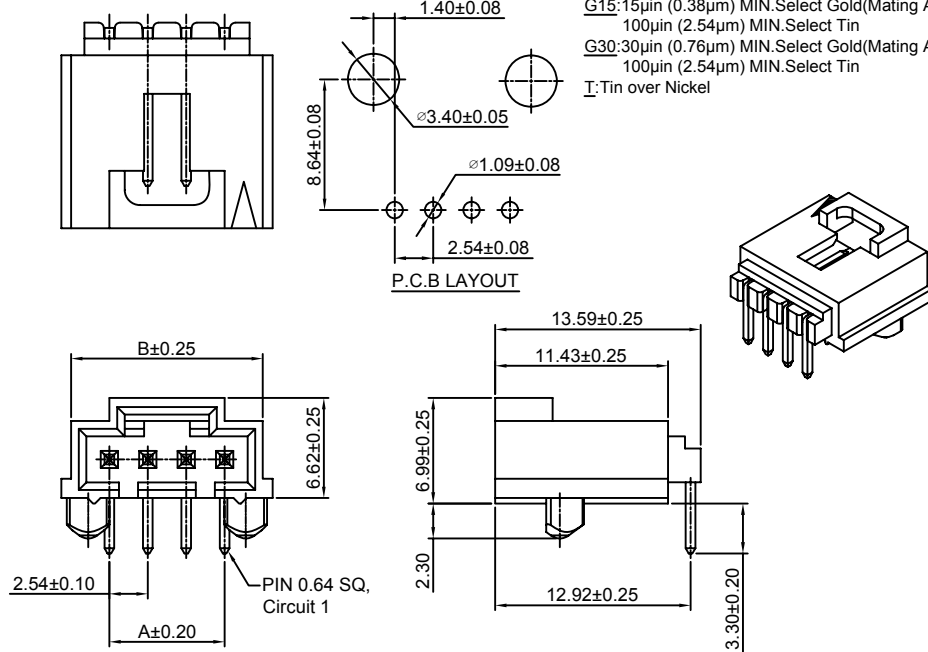

A2547WR-S-F-XP

2.54mm Pitch 90° Wafer-SMT TYPE

Reference Informations:

- *Material: Pin: Brass/Gold over Nickel
Insulator: Nylon 6T, UL94V-0
- *Mates with CJT A2547H-XP(-2,-3), A2547HA, HB-XP, A2550H-XP-(A,A1,A2,A3H,B,H,G,M,M1,M2), A2541H-XP series Housing
- *Color: Black

Ordering Information:
A2547WR-S-F-XP - *** - ***
1 2 3

- Part No.
- Material:
(Blank): Nylon 6T, UL94V-0
GWT: Nylon 6T, UL94V-0, GWT 750°C
- Finish:
(blank): Gold-flash
G15: 15µin (0.38µm) MIN. Select Gold (Mating Area)
100µin (2.54µm) MIN. Select Tin
G30: 30µin (0.76µm) MIN. Select Gold (Mating Area)
100µin (2.54µm) MIN. Select Tin
T: Tin over Nickel

Ordering Information & Dimensions:

| PART NO. | Dimensions | |
|----------|------------|-------|
| | A | B |
| 2P | 2.54 | 7.62 |
| 3P | 5.08 | 10.16 |
| 4P | 7.62 | 12.70 |
| 5P | 10.16 | 15.24 |
| 6P | 12.70 | 17.78 |
| 7P | 15.24 | 20.32 |
| 8P | 17.78 | 22.86 |
| 9P | 20.32 | 25.40 |
| 10P | 22.86 | 27.94 |
| 11P | 25.40 | 30.48 |
| 12P | 27.94 | 33.02 |
| 13P | 30.48 | 35.56 |
| 14P | 33.02 | 38.10 |
| 15P | 35.56 | 40.64 |
| 16P | 38.10 | 43.18 |
| 17P | 40.64 | 45.72 |
| 18P | 43.18 | 48.26 |
| 19P | 45.72 | 50.80 |
| 20P | 48.26 | 53.34 |
| 21P | 50.80 | 55.88 |
| 22P | 53.34 | 58.42 |
| 23P | 55.88 | 60.96 |
| 24P | 58.42 | 63.50 |
| 25P | 60.96 | 66.04 |

Unit: mm

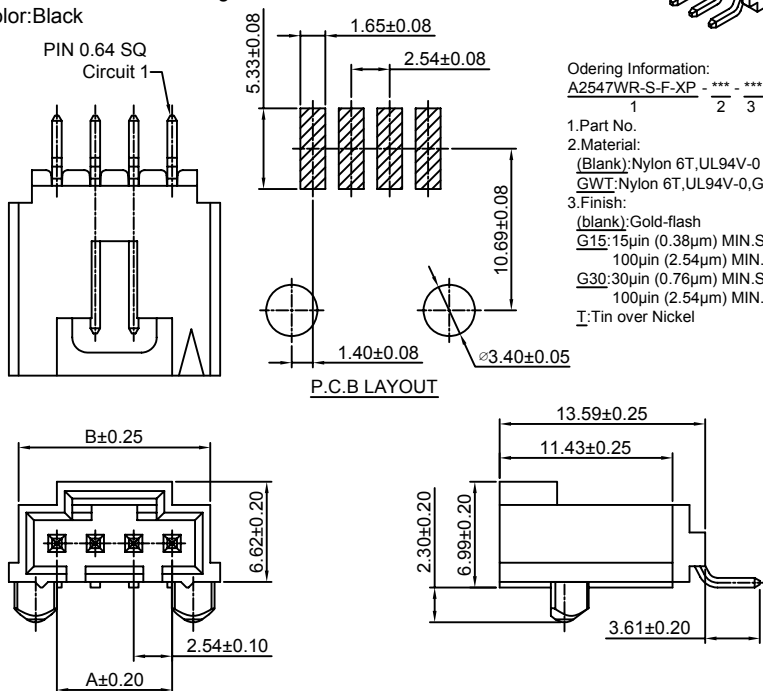

A2547WVA-XP

2.54mm Pitch 180° Wafer

Reference Informations:

*Material:Pin:Brass/Tin over Nickel
Insulator:PBT,UL94V-0

*Mates with CJT A2547H-XP(-2,-3),A2547HA,HB-XP, A2550H-XP-(A,A1,A2,A3H,B,H,G,M,M1,M2), A2541H-XP series Housing

*Color:Black



Ordering Information:

A2547WVA-XP - *** - ***
1 2 3

1.Part No.

2.Material:

(Blank):PBT,UL94V-0

6T:Nylon 6T,UL94V-0

GWT:PBT,UL94V-0,GWT 750 °C

3.Finish:

(Blank):Tin over Nickel

G:Gold-flash

G15:15 μ m (0.38 μ m) MIN.Select Gold(Mating Area)

100 μ m (2.54 μ m) MIN.Select Tin

G30:30 μ m (0.76 μ m) MIN.Select Gold(Mating Area)

100 μ m (2.54 μ m) MIN.Select Tin

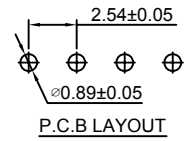

Ordering Information & Dimensions:

| PART NO. | Dimensions | | |
|----------|------------|-------|-------|
| | A | B | C |
| 2P | 2.54 | 7.62 | 5.59 |
| 3P | 5.08 | 10.16 | 8.13 |
| 4P | 7.62 | 12.70 | 10.67 |
| 5P | 10.16 | 15.24 | 13.21 |
| 6P | 12.70 | 17.78 | 15.75 |
| 7P | 15.24 | 20.32 | 18.29 |
| 8P | 17.78 | 22.86 | 20.83 |
| 9P | 20.32 | 25.40 | 23.37 |
| 10P | 22.86 | 27.94 | 25.91 |
| 11P | 25.40 | 30.48 | 28.45 |
| 12P | 27.94 | 33.02 | 30.99 |
| 13P | 30.48 | 35.56 | 33.53 |
| 14P | 33.02 | 38.10 | 36.07 |
| 15P | 35.56 | 40.64 | 38.61 |
| 16P | 38.10 | 43.18 | 41.15 |
| 17P | 40.64 | 45.72 | 43.69 |
| 18P | 43.18 | 48.26 | 46.23 |
| 19P | 45.72 | 50.80 | 48.77 |
| 20P | 48.26 | 53.34 | 51.31 |
| 21P | 50.80 | 55.88 | 53.85 |
| 22P | 53.34 | 58.42 | 56.39 |
| 23P | 55.88 | 60.96 | 58.93 |
| 24P | 58.42 | 63.50 | 61.47 |
| 25P | 60.96 | 66.04 | 64.01 |

Unit: mm

A2547WRA-XP

2.54mm Pitch 90° Wafer

Reference Informations:

*Material:Pin:Brass/Tin over Nickel
Insulator:PBT,UL94V-0

*Mates with CJT A2547H-XP(-2,-3),A2547HA,HB-XP, A2550H-XP-(A,A1,A2,A3H,B,H,G,M,M1,M2), A2541H-XP series Housing

*Color:Black

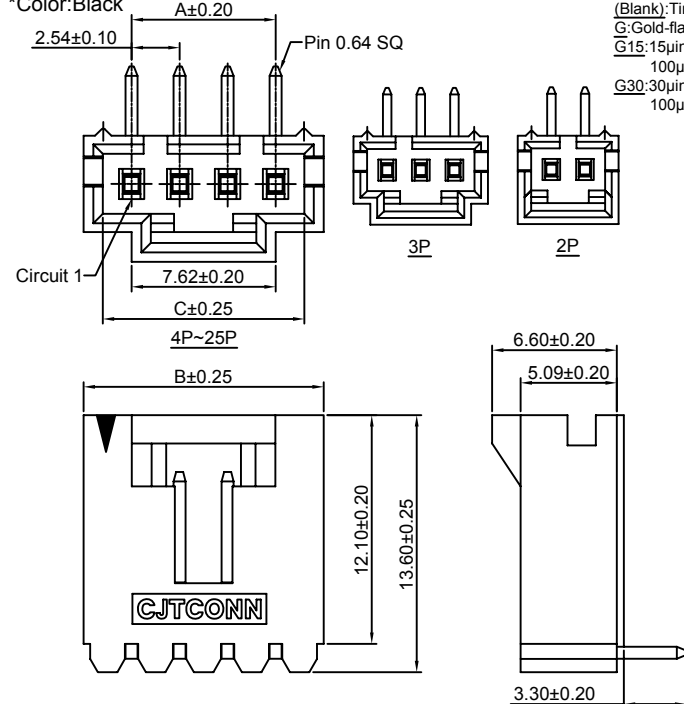

Ordering Information:

A2547WRA-XP - *** - ***
1 2 3

1.Part No.

2.Material:

(Blank):PBT,UL94V-0

6T:Nylon 6T,UL94V-0

GWT:PBT,UL94V-0,GWT 750 °C

3.Finish:

(Blank):Tin over Nickel

G:Gold-flash

G15:15 μ m (0.38 μ m) MIN.Select Gold(Mating Area)

100 μ m (2.54 μ m) MIN.Select Tin

G30:30 μ m (0.76 μ m) MIN.Select Gold(Mating Area)

100 μ m (2.54 μ m) MIN.Select Tin

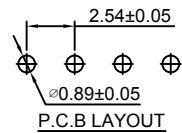

Ordering Information & Dimensions:

| PART NO. | Dimensions | | |
|----------|------------|-------|-------|
| | A | B | C |
| 2P | 2.54 | 7.62 | 5.59 |
| 3P | 5.08 | 10.16 | 8.13 |
| 4P | 7.62 | 12.70 | 10.67 |
| 5P | 10.16 | 15.24 | 13.21 |
| 6P | 12.70 | 17.78 | 15.75 |
| 7P | 15.24 | 20.32 | 18.29 |
| 8P | 17.78 | 22.86 | 20.83 |
| 9P | 20.32 | 25.40 | 23.37 |
| 10P | 22.86 | 27.94 | 25.91 |
| 11P | 25.40 | 30.48 | 28.45 |
| 12P | 27.94 | 33.02 | 30.99 |
| 13P | 30.48 | 35.56 | 33.53 |
| 14P | 33.02 | 38.10 | 36.07 |
| 15P | 35.56 | 40.64 | 38.61 |
| 16P | 38.10 | 43.18 | 41.15 |
| 17P | 40.64 | 45.72 | 43.69 |
| 18P | 43.18 | 48.26 | 46.23 |
| 19P | 45.72 | 50.80 | 48.77 |
| 20P | 48.26 | 53.34 | 51.31 |
| 21P | 50.80 | 55.88 | 53.85 |
| 22P | 53.34 | 58.42 | 56.39 |
| 23P | 55.88 | 60.96 | 58.93 |
| 24P | 58.42 | 63.50 | 61.47 |
| 25P | 60.96 | 66.04 | 64.01 |

Unit: mm

A2547WVA-F1-XP

2.54mm Pitch 180° Wafer

Reference Informations:

- *Material: Pin: Brass/Tin over Nickel
Insulator: PBT, UL94V-0
- *Mates with CJT A2547H-XP(-2,-3), A2547HA, HB-XP, A2550H-XP-(A,A1,A2,A3H,B,H,G,M,M1,M2), A2541H-XP series Housing
- *Color: Black

Ordering Information:
A2547WVA-F1-XP - *** - ***
1 2 3

- Part No.
- Material:
(Blank): PBT, UL94V-0
6T: Nylon 6T, UL94V-0
GWT: PBT, UL94V-0, GWT 750°C
- Finish:
(Blank): Tin over Nickel
G: Gold-flash
G15: 15µin (0.38µm) MIN. Select Gold (Mating Area)
100µin (2.54µm) MIN. Select Tin
G30: 30µin (0.76µm) MIN. Select Gold (Mating Area)
100µin (2.54µm) MIN. Select Tin



Ordering Information & Dimensions:

| PART NO. | Dimensions | | |
|----------|------------|-------|-------|
| | A | B | C |
| 2P | 2.54 | 7.62 | 5.59 |
| 3P | 5.08 | 10.16 | 8.13 |
| 4P | 7.62 | 12.70 | 10.67 |
| 5P | 10.16 | 15.24 | 13.21 |
| 6P | 12.70 | 17.78 | 15.75 |
| 7P | 15.24 | 20.32 | 18.29 |
| 8P | 17.78 | 22.86 | 20.83 |
| 9P | 20.32 | 25.40 | 23.37 |
| 10P | 22.86 | 27.94 | 25.91 |
| 11P | 25.40 | 30.48 | 28.45 |
| 12P | 27.94 | 33.02 | 30.99 |
| 13P | 30.48 | 35.56 | 33.53 |
| 14P | 33.02 | 38.10 | 36.07 |
| 15P | 35.56 | 40.64 | 38.61 |
| 16P | 38.10 | 43.18 | 41.15 |
| 17P | 40.64 | 45.72 | 43.69 |
| 18P | 43.18 | 48.26 | 46.23 |
| 19P | 45.72 | 50.80 | 48.77 |
| 20P | 48.26 | 53.34 | 51.31 |
| 21P | 50.80 | 55.88 | 53.85 |
| 22P | 53.34 | 58.42 | 56.39 |
| 23P | 55.88 | 60.96 | 58.93 |
| 24P | 58.42 | 63.50 | 61.47 |
| 25P | 60.96 | 66.04 | 64.01 |

Unit: mm

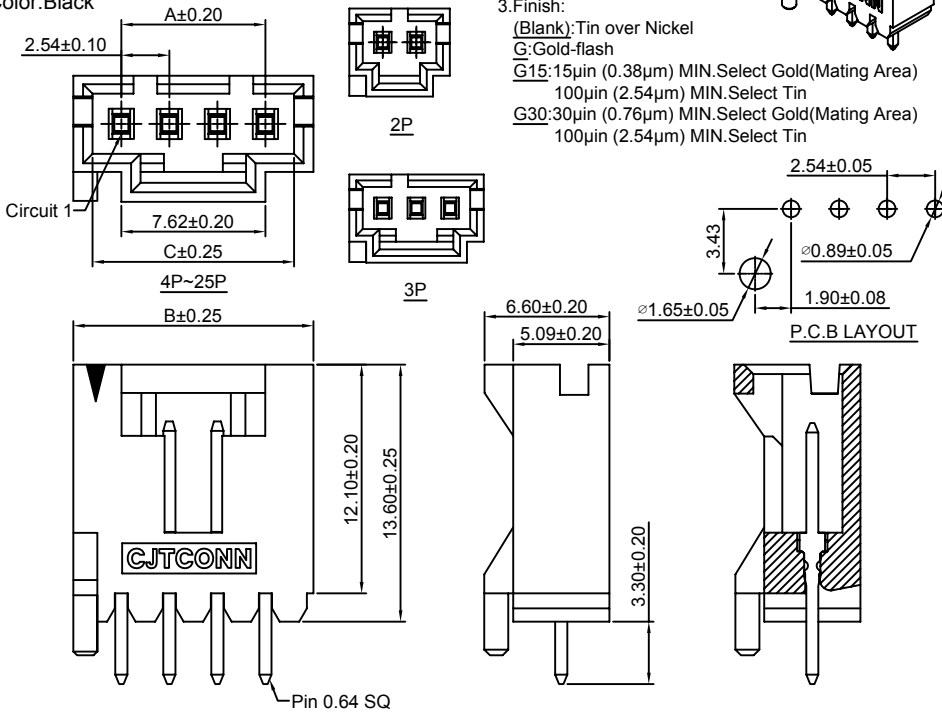

A2547WRA-F1-XP

2.54mm Pitch 90° Wafer

Reference Informations:

- *Material: Pin: Brass/Tin over Nickel
Insulator: PBT, UL94V-0
- *Mates with CJT A2547H-XP(-2,-3), A2547HA, HB-XP, A2550H-XP-(A,A1,A2,A3H,B,H,G,M,M1,M2), A2541H-XP series Housing
- *Color: Black

Ordering Information:
A2547WRA-F1-XP - *** - ***
1 2 3

- Part No.
- Material:
(Blank): PBT, UL94V-0
6T: Nylon 6T, UL94V-0
GWT: PBT, UL94V-0, GWT 750°C
- Finish:
(Blank): Tin over Nickel
G: Gold-flash
G15: 15µin (0.38µm) MIN. Select Gold (Mating Area)
100µin (2.54µm) MIN. Select Tin
G30: 30µin (0.76µm) MIN. Select Gold (Mating Area)
100µin (2.54µm) MIN. Select Tin



Ordering Information & Dimensions:

| PART NO. | Dimensions | | |
|----------|------------|-------|-------|
| | A | B | C |
| 2P | 2.54 | 7.62 | 5.59 |
| 3P | 5.08 | 10.16 | 8.13 |
| 4P | 7.62 | 12.70 | 10.67 |
| 5P | 10.16 | 15.24 | 13.21 |
| 6P | 12.70 | 17.78 | 15.75 |
| 7P | 15.24 | 20.32 | 18.29 |
| 8P | 17.78 | 22.86 | 20.83 |
| 9P | 20.32 | 25.40 | 23.37 |
| 10P | 22.86 | 27.94 | 25.91 |
| 11P | 25.40 | 30.48 | 28.45 |
| 12P | 27.94 | 33.02 | 30.99 |
| 13P | 30.48 | 35.56 | 33.53 |
| 14P | 33.02 | 38.10 | 36.07 |
| 15P | 35.56 | 40.64 | 38.61 |
| 16P | 38.10 | 43.18 | 41.15 |
| 17P | 40.64 | 45.72 | 43.69 |
| 18P | 43.18 | 48.26 | 46.23 |
| 19P | 45.72 | 50.80 | 48.77 |
| 20P | 48.26 | 53.34 | 51.31 |
| 21P | 50.80 | 55.88 | 53.85 |
| 22P | 53.34 | 58.42 | 56.39 |
| 23P | 55.88 | 60.96 | 58.93 |
| 24P | 58.42 | 63.50 | 61.47 |
| 25P | 60.96 | 66.04 | 64.01 |

Unit: mm

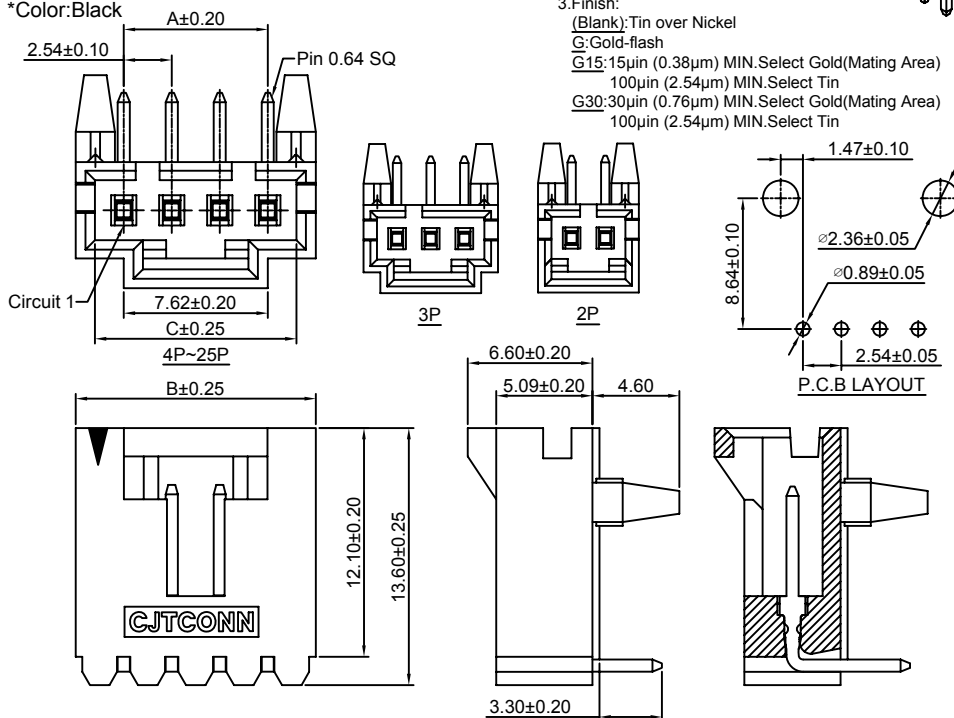

A2547WRA-FJ-XP

2.54mm Pitch 90° Wafer

Reference Informations:

- *Material:Pin:Brass/Tin over Nickel
Insulator:PBT,UL94V-0
- *Mates with CJT A2547H-XP(-2,-3),A2547HA,HB-XP, A2550H-XP-(A,A1,A2,A3H,B,H,G,M,M1,M2), A2541H-XP series Housing
- *Color:Black

- Odering Information:
A2547WRA-FJ-XP - *** - ***
1 2 3
- 1.Part No.
 - 2.Material:
(Blank):PBT,UL94V-0
6T:Nylon 6T,UL94V-0
GWT:PBT,UL94V-0,GWT 750°C
 - 3.Finish:
(Blank):Tin over Nickel
G:Gold-flash
G15:15µin (0.38µm) MIN.Select Gold(Mating Area)
100µin (2.54µm) MIN.Select Tin
G30:30µin (0.76µm) MIN.Select Gold(Mating Area)
100µin (2.54µm) MIN.Select Tin

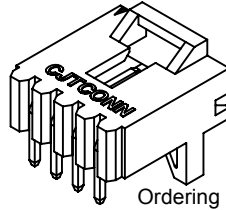

Ordering Information & Dimensions:

| PART NO. | Dimensions | | |
|----------|------------|-------|-------|
| | A | B | C |
| 2P | 2.54 | 7.62 | 5.59 |
| 3P | 5.08 | 10.16 | 8.13 |
| 4P | 7.62 | 12.70 | 10.67 |
| 5P | 10.16 | 15.24 | 13.21 |
| 6P | 12.70 | 17.78 | 15.75 |
| 7P | 15.24 | 20.32 | 18.29 |
| 8P | 17.78 | 22.86 | 20.83 |
| 9P | 20.32 | 25.40 | 23.37 |
| 10P | 22.86 | 27.94 | 25.91 |
| 11P | 25.40 | 30.48 | 28.45 |
| 12P | 27.94 | 33.02 | 30.99 |
| 13P | 30.48 | 35.56 | 33.53 |
| 14P | 33.02 | 38.10 | 36.07 |
| 15P | 35.56 | 40.64 | 38.61 |
| 16P | 38.10 | 43.18 | 41.15 |
| 17P | 40.64 | 45.72 | 43.69 |
| 18P | 43.18 | 48.26 | 46.23 |
| 19P | 45.72 | 50.80 | 48.77 |
| 20P | 48.26 | 53.34 | 51.31 |
| 21P | 50.80 | 55.88 | 53.85 |
| 22P | 53.34 | 58.42 | 56.39 |
| 23P | 55.88 | 60.96 | 58.93 |
| 24P | 58.42 | 63.50 | 61.47 |
| 25P | 60.96 | 66.04 | 64.01 |

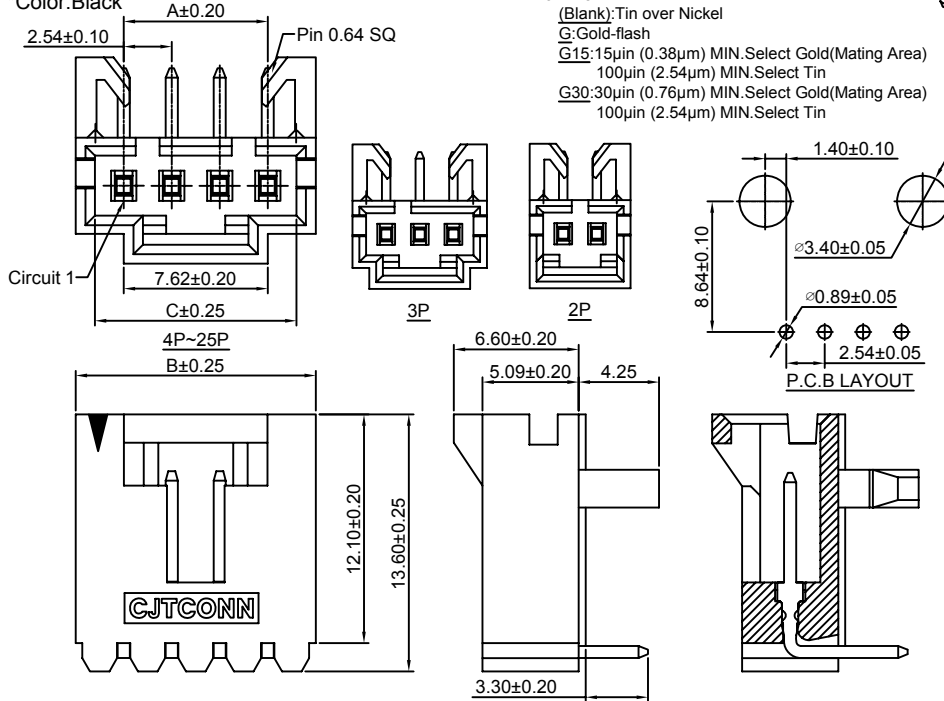

Unit: mm

A2547WVA-F-XP

2.54mm Pitch 180° Wafer

Reference Informations:

- *Material:Pin:Brass/Tin over Nickel
Insulator:PBT,UL94V-0
- *Mates with CJT A2547H-XP(-2,-3),A2547HA,HB-XP, A2550H-XP-(A,A1,A2,A3H,B,H,G,M,M1,M2), A2541H-XP series Housing
- *Color:Black

- Odering Information:
A2547WVA-F-XP - *** - ***
1 2 3
- 1.Part No.
 - 2.Material:
(Blank):PBT,UL94V-0
6T:Nylon 6T,UL94V-0
GWT:PBT,UL94V-0,GWT 750°C
 - 3.Finish:
(Blank):Tin over Nickel
G:Gold-flash
G15:15µin (0.38µm) MIN.Select Gold(Mating Area)
100µin (2.54µm) MIN.Select Tin
G30:30µin (0.76µm) MIN.Select Gold(Mating Area)
100µin (2.54µm) MIN.Select Tin

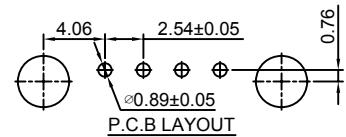

Ordering Information & Dimensions:

| PART NO. | Dimensions | | |
|----------|------------|-------|-------|
| | A | B | C |
| 2P | 2.54 | 7.62 | 5.59 |
| 3P | 5.08 | 10.16 | 8.13 |
| 4P | 7.62 | 12.70 | 10.67 |
| 5P | 10.16 | 15.24 | 13.21 |
| 6P | 12.70 | 17.78 | 15.75 |
| 7P | 15.24 | 20.32 | 18.29 |
| 8P | 17.78 | 22.86 | 20.83 |
| 9P | 20.32 | 25.40 | 23.37 |
| 10P | 22.86 | 27.94 | 25.91 |
| 11P | 25.40 | 30.48 | 28.45 |
| 12P | 27.94 | 33.02 | 30.99 |
| 13P | 30.48 | 35.56 | 33.53 |
| 14P | 33.02 | 38.10 | 36.07 |
| 15P | 35.56 | 40.64 | 38.61 |
| 16P | 38.10 | 43.18 | 41.15 |
| 17P | 40.64 | 45.72 | 43.69 |
| 18P | 43.18 | 48.26 | 46.23 |
| 19P | 45.72 | 50.80 | 48.77 |
| 20P | 48.26 | 53.34 | 51.31 |
| 21P | 50.80 | 55.88 | 53.85 |
| 22P | 53.34 | 58.42 | 56.39 |
| 23P | 55.88 | 60.96 | 58.93 |
| 24P | 58.42 | 63.50 | 61.47 |
| 25P | 60.96 | 66.04 | 64.01 |

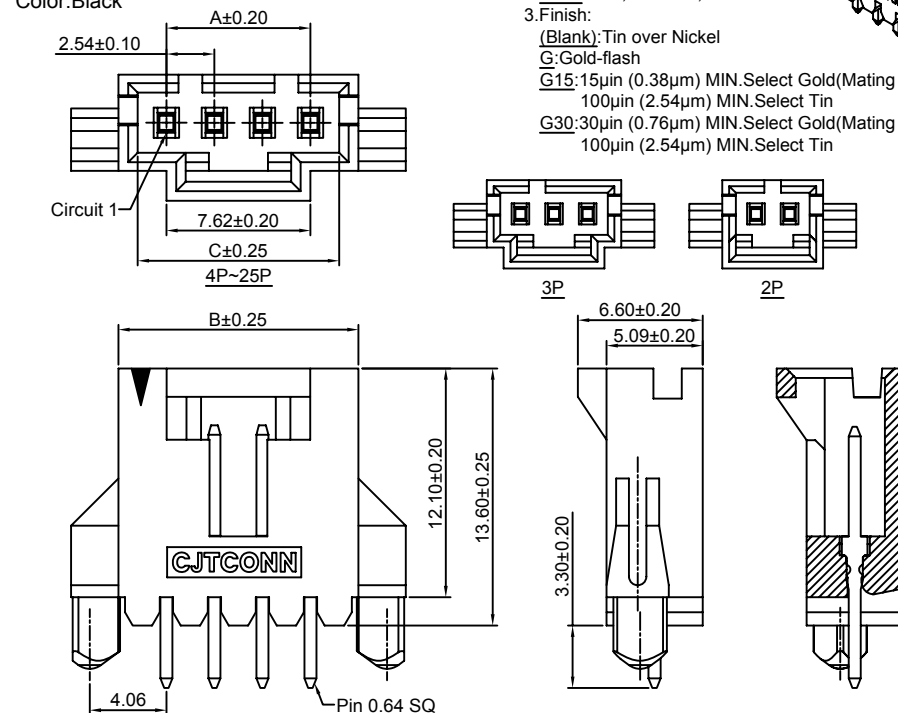

Unit: mm

A2547WRA-F-XP

2.54mm Pitch 90° Wafer

Reference Informations:

- *Material: Pin: Brass/Tin over Nickel
Insulator: PBT, UL94V-0
- *Mates with CJT A2547H-XP(-2,-3), A2547HA, HB-XP, A2550H-XP-(A,A1,A2,A3H,B,H,G,M,M1,M2), A2541H-XP series Housing
- *Color: Black

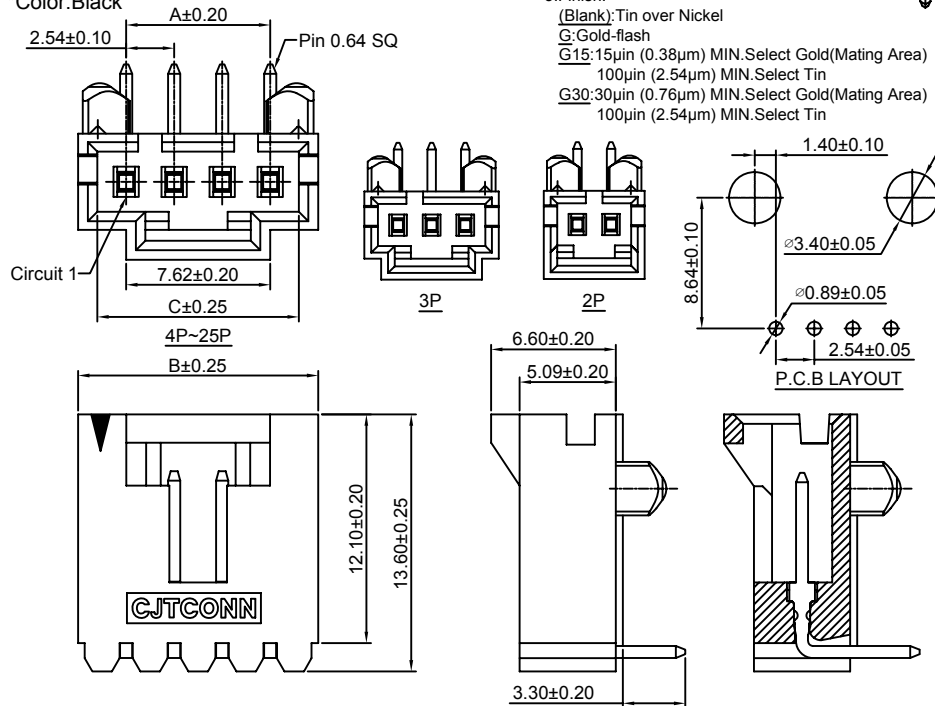

Odering Information:
A2547WRA-F-XP - *** - ***
1 2 3

- 1.Part No.
- 2.Material:
(Blank): PBT, UL94V-0
6T: Nylon 6T, UL94V-0
GWT: PBT, UL94V-0, GWT 750°C
- 3.Finish:
(Blank): Tin over Nickel
G: Gold-flash
G15: 15µin (0.38µm) MIN. Select Gold (Mating Area)
100µin (2.54µm) MIN. Select Tin
G30: 30µin (0.76µm) MIN. Select Gold (Mating Area)
100µin (2.54µm) MIN. Select Tin

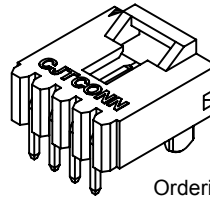

Ordering Information & Dimensions:

| PART NO. | Dimensions | | |
|----------|------------|-------|-------|
| | A | B | C |
| 2P | 2.54 | 7.62 | 5.59 |
| 3P | 5.08 | 10.16 | 8.13 |
| 4P | 7.62 | 12.70 | 10.67 |
| 5P | 10.16 | 15.24 | 13.21 |
| 6P | 12.70 | 17.78 | 15.75 |
| 7P | 15.24 | 20.32 | 18.29 |
| 8P | 17.78 | 22.86 | 20.83 |
| 9P | 20.32 | 25.40 | 23.37 |
| 10P | 22.86 | 27.94 | 25.91 |
| 11P | 25.40 | 30.48 | 28.45 |
| 12P | 27.94 | 33.02 | 30.99 |
| 13P | 30.48 | 35.56 | 33.53 |
| 14P | 33.02 | 38.10 | 36.07 |
| 15P | 35.56 | 40.64 | 38.61 |
| 16P | 38.10 | 43.18 | 41.15 |
| 17P | 40.64 | 45.72 | 43.69 |
| 18P | 43.18 | 48.26 | 46.23 |
| 19P | 45.72 | 50.80 | 48.77 |
| 20P | 48.26 | 53.34 | 51.31 |
| 21P | 50.80 | 55.88 | 53.85 |
| 22P | 53.34 | 58.42 | 56.39 |
| 23P | 55.88 | 60.96 | 58.93 |
| 24P | 58.42 | 63.50 | 61.47 |
| 25P | 60.96 | 66.04 | 64.01 |

Unit: mm

A2547WVA-F2-XP

2.54mm Pitch 180° Wafer

Reference Informations:

- *Material: Pin: Brass/Tin over Nickel
Insulator: PBT, UL94V-0
- *Mates with CJT A2547H-XP(-2,-3), A2547HA, HB-XP, A2550H-XP-(A,A1,A2,A3H,B,H,G,M,M1,M2), A2541H-XP series Housing
- *Color: Black



Odering Information:
A2547WVA-F2-XP - *** - ***
1 2 3

- 1.Part No.
- 2.Material:
(Blank): PBT, UL94V-0
6T: Nylon 6T, UL94V-0
GWT: PBT, UL94V-0, GWT 750°C
- 3.Finish:
(Blank): Tin over Nickel
G: Gold-flash
G15: 15µin (0.38µm) MIN. Select Gold (Mating Area)
100µin (2.54µm) MIN. Select Tin
G30: 30µin (0.76µm) MIN. Select Gold (Mating Area)
100µin (2.54µm) MIN. Select Tin

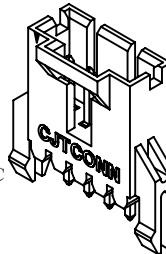

Ordering Information & Dimensions:

| PART NO. | Dimensions | | |
|----------|------------|-------|-------|
| | A | B | C |
| 2P | 2.54 | 7.62 | 5.59 |
| 3P | 5.08 | 10.16 | 8.13 |
| 4P | 7.62 | 12.70 | 10.67 |
| 5P | 10.16 | 15.24 | 13.21 |
| 6P | 12.70 | 17.78 | 15.75 |
| 7P | 15.24 | 20.32 | 18.29 |
| 8P | 17.78 | 22.86 | 20.83 |
| 9P | 20.32 | 25.40 | 23.37 |
| 10P | 22.86 | 27.94 | 25.91 |
| 11P | 25.40 | 30.48 | 28.45 |
| 12P | 27.94 | 33.02 | 30.99 |
| 13P | 30.48 | 35.56 | 33.53 |
| 14P | 33.02 | 38.10 | 36.07 |
| 15P | 35.56 | 40.64 | 38.61 |
| 16P | 38.10 | 43.18 | 41.15 |
| 17P | 40.64 | 45.72 | 43.69 |
| 18P | 43.18 | 48.26 | 46.23 |
| 19P | 45.72 | 50.80 | 48.77 |
| 20P | 48.26 | 53.34 | 51.31 |
| 21P | 50.80 | 55.88 | 53.85 |
| 22P | 53.34 | 58.42 | 56.39 |
| 23P | 55.88 | 60.96 | 58.93 |
| 24P | 58.42 | 63.50 | 61.47 |
| 25P | 60.96 | 66.04 | 64.01 |

Unit: mm

A2547WRA-F2-XP

2.54mm Pitch 90° Wafer

Reference Informations:

- *Material: Pin: Brass/Tin over Nickel
Insulator: PBT, UL94V-0
- *Mates with CJT A2547H-XP(-2,-3), A2547HA, HB-XP, A2550H-XP-(A,A1,A2,A3H,B,H,G,M,M1,M2), A2541H-XP series Housing
- *Color: Black

Odering Information:
A2547WRA-F2-XP - *** - ***
1 2 3

- Part No.
- Material:
(Blank): PBT, UL94V-0
6T: Nylon 6T, UL94V-0
GWT: PBT, UL94V-0, GWT 750°C
- Finish:
(Blank): Tin over Nickel
G: Gold-flash
G15: 15µin (0.38µm) MIN. Select Gold (Mating Area)
100µin (2.54µm) MIN. Select Tin
G30: 30µin (0.76µm) MIN. Select Gold (Mating Area)
100µin (2.54µm) MIN. Select Tin

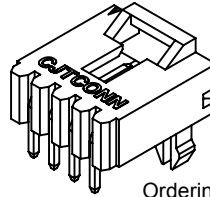

Ordering Information & Dimensions:

| PART NO. | Dimensions | | |
|----------|------------|-------|-------|
| | A | B | C |
| 2P | 2.54 | 7.62 | 5.59 |
| 3P | 5.08 | 10.16 | 8.13 |
| 4P | 7.62 | 12.70 | 10.67 |
| 5P | 10.16 | 15.24 | 13.21 |
| 6P | 12.70 | 17.78 | 15.75 |
| 7P | 15.24 | 20.32 | 18.29 |
| 8P | 17.78 | 22.86 | 20.83 |
| 9P | 20.32 | 25.40 | 23.37 |
| 10P | 22.86 | 27.94 | 25.91 |
| 11P | 25.40 | 30.48 | 28.45 |
| 12P | 27.94 | 33.02 | 30.99 |
| 13P | 30.48 | 35.56 | 33.53 |
| 14P | 33.02 | 38.10 | 36.07 |
| 15P | 35.56 | 40.64 | 38.61 |
| 16P | 38.10 | 43.18 | 41.15 |
| 17P | 40.64 | 45.72 | 43.69 |
| 18P | 43.18 | 48.26 | 46.23 |
| 19P | 45.72 | 50.80 | 48.77 |
| 20P | 48.26 | 53.34 | 51.31 |
| 21P | 50.80 | 55.88 | 53.85 |
| 22P | 53.34 | 58.42 | 56.39 |
| 23P | 55.88 | 60.96 | 58.93 |
| 24P | 58.42 | 63.50 | 61.47 |
| 25P | 60.96 | 66.04 | 64.01 |

Unit: mm

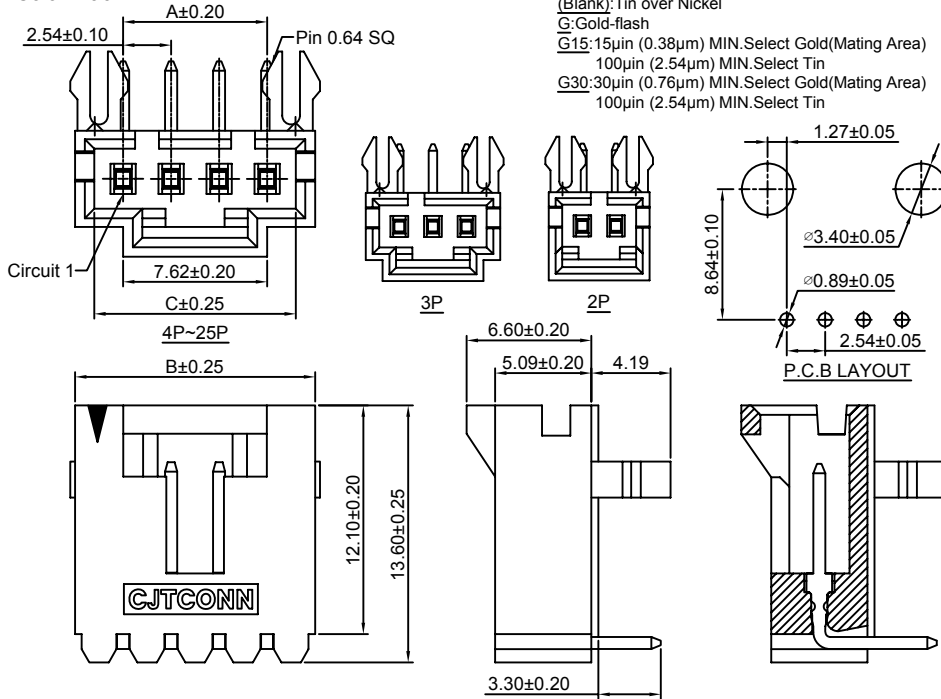

A2547WRA-S-F-XP

2.54mm Pitch 90° Wafer - SMT TYPE

Reference Informations:

- *Material: Pin: Brass/Tin over Nickel
Insulator: LCP, UL94V-0
- *Mates with CJT A2547H-XP(-2,-3), A2547HA, HB-XP, A2550H-XP-(A,A1,A2,A3H,B,H,G,M,M1,M2), A2541H-XP series Housing
- *Color: Black

Odering Information:
A2547WRA-S-F-XP - *** - ***
1 2 3

- Part No.
- Material:
(Blank): LCP, UL94V-0
6T: Nylon 6T, UL94V-0
GWT: LCP, UL94V-0, GWT 750°C
- Finish:
(Blank): Tin over Nickel
G: Gold-flash
G15: 15µin (0.38µm) MIN. Select Gold (Mating Area)
100µin (2.54µm) MIN. Select Tin
G30: 30µin (0.76µm) MIN. Select Gold (Mating Area)
100µin (2.54µm) MIN. Select Tin

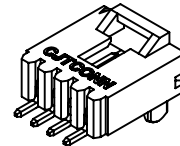

Ordering Information & Dimensions:

| PART NO. | Dimensions | | |
|----------|------------|-------|-------|
| | A | B | C |
| 2P | 2.54 | 7.62 | 5.59 |
| 3P | 5.08 | 10.16 | 8.13 |
| 4P | 7.62 | 12.70 | 10.67 |
| 5P | 10.16 | 15.24 | 13.21 |
| 6P | 12.70 | 17.78 | 15.75 |
| 7P | 15.24 | 20.32 | 18.29 |
| 8P | 17.78 | 22.86 | 20.83 |
| 9P | 20.32 | 25.40 | 23.37 |
| 10P | 22.86 | 27.94 | 25.91 |
| 11P | 25.40 | 30.48 | 28.45 |
| 12P | 27.94 | 33.02 | 30.99 |
| 13P | 30.48 | 35.56 | 33.53 |
| 14P | 33.02 | 38.10 | 36.07 |
| 15P | 35.56 | 40.64 | 38.61 |
| 16P | 38.10 | 43.18 | 41.15 |
| 17P | 40.64 | 45.72 | 43.69 |
| 18P | 43.18 | 48.26 | 46.23 |
| 19P | 45.72 | 50.80 | 48.77 |
| 20P | 48.26 | 53.34 | 51.31 |
| 21P | 50.80 | 55.88 | 53.85 |
| 22P | 53.34 | 58.42 | 56.39 |
| 23P | 55.88 | 60.96 | 58.93 |
| 24P | 58.42 | 63.50 | 61.47 |
| 25P | 60.96 | 66.04 | 64.01 |

Unit: mm

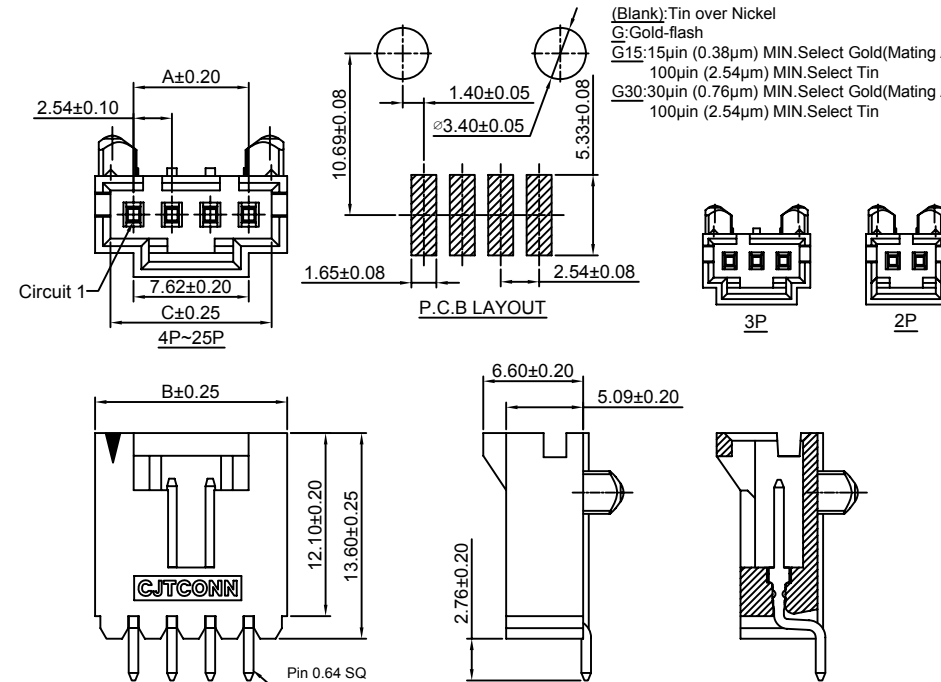

A2547WVE-XP

2.54mm Pitch 180° Wafer

Reference Informations:

- *Material: Pin: Brass/Tin over Nickel
Insulator: PBT, UL94V-0
- *Mates with CJT A2549H, HA-XP, A2550H-XP-C
A2550H-XP-C1, A2550H-XP-I series Housing
- *Color: Black

Ordering Information:

A2547WVE-XP - *** - ***
1 2 3

- Part No.
- Material:
(blank): PBT, UL94V-0
6T: Nylon 6T, UL94V-0
GWT: PBT, UL94V-0, GWT 750 °C
- Finish:
(Blank): Tin over Nickel
G: Gold-flash
G15: 15µin (0.38µm) MIN. Select Gold (Mating Area)
100µin (2.54µm) MIN. Select Tin
G30: 30µin (0.76µm) MIN. Select Gold (Mating Area)
100µin (2.54µm) MIN. Select Tin

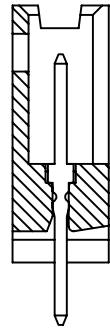
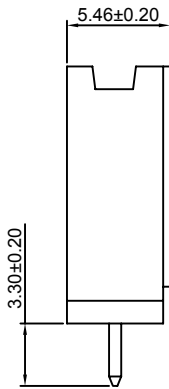
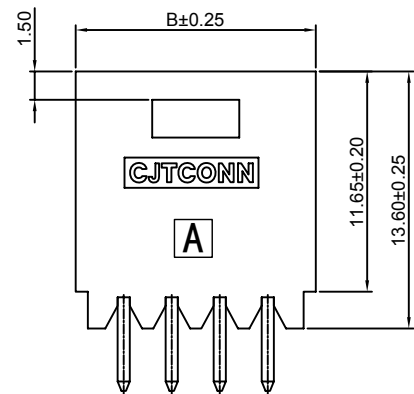
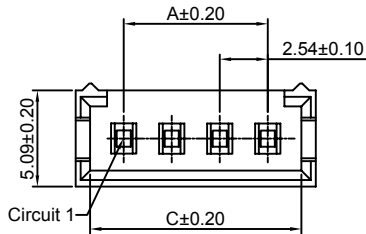
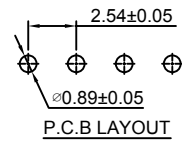
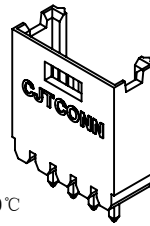

Ordering Information & Dimensions:

| PART NO. | Dimensions | | |
|----------|------------|-------|-------|
| | A | B | C |
| 2P | 2.54 | 7.62 | 5.59 |
| 3P | 5.08 | 10.16 | 8.13 |
| 4P | 7.62 | 12.70 | 10.67 |
| 5P | 10.16 | 15.24 | 13.21 |
| 6P | 12.70 | 17.78 | 15.75 |
| 7P | 15.24 | 20.32 | 18.29 |
| 8P | 17.78 | 22.86 | 20.83 |
| 9P | 20.32 | 25.40 | 23.37 |
| 10P | 22.86 | 27.94 | 25.91 |
| 11P | 25.40 | 30.48 | 28.45 |
| 12P | 27.94 | 33.02 | 30.99 |
| 13P | 30.48 | 35.56 | 33.53 |
| 14P | 33.02 | 38.10 | 36.07 |
| 15P | 35.56 | 40.64 | 38.61 |
| 16P | 38.10 | 43.18 | 41.15 |
| 17P | 40.64 | 45.72 | 43.69 |
| 18P | 43.18 | 48.26 | 46.23 |
| 19P | 45.72 | 50.80 | 48.77 |
| 20P | 48.26 | 53.34 | 51.31 |
| 21P | 50.80 | 55.88 | 53.85 |
| 22P | 53.34 | 58.42 | 56.39 |
| 23P | 55.88 | 60.96 | 58.93 |
| 24P | 58.42 | 63.50 | 61.47 |
| 25P | 60.96 | 66.04 | 64.01 |

Unit: mm

A2547WRE-XP

2.54mm Pitch 90° Wafer

Reference Informations:

- *Material: Pin: Brass/Tin over Nickel
Insulator: PBT, UL94V-0
- *Mates with CJT A2549H, HA-XP, A2550H-XP-C
A2550H-XP-C1, A2550H-XP-I series Housing
- *Color: Black

Ordering Information:

A2547WRE-XP - *** - ***
1 2 3

- Part No.
- Material:
(blank): PBT, UL94V-0
6T: Nylon 6T, UL94V-0
GWT: PBT, UL94V-0, GWT 750 °C
- Finish:
(Blank): Tin over Nickel
G: Gold-flash
G15: 15µin (0.38µm) MIN. Select Gold (Mating Area)
100µin (2.54µm) MIN. Select Tin
G30: 30µin (0.76µm) MIN. Select Gold (Mating Area)
100µin (2.54µm) MIN. Select Tin

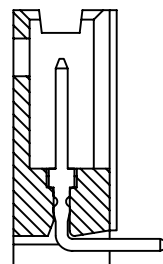
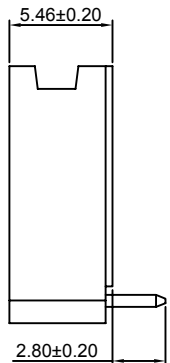
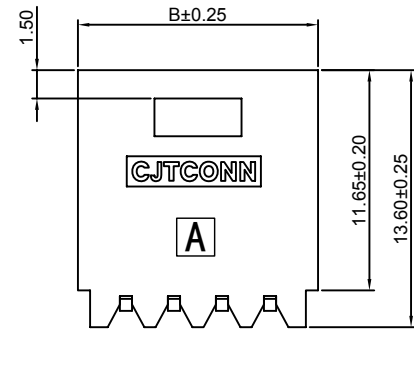
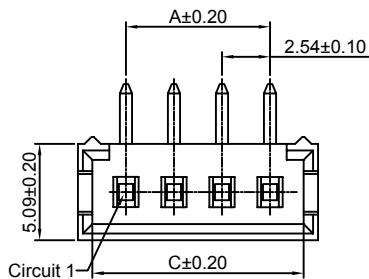
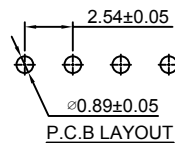
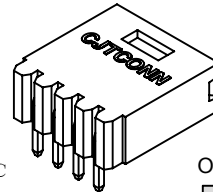

Ordering Information & Dimensions:

| PART NO. | Dimensions | | |
|----------|------------|-------|-------|
| | A | B | C |
| 2P | 2.54 | 7.62 | 5.59 |
| 3P | 5.08 | 10.16 | 8.13 |
| 4P | 7.62 | 12.70 | 10.67 |
| 5P | 10.16 | 15.24 | 13.21 |
| 6P | 12.70 | 17.78 | 15.75 |
| 7P | 15.24 | 20.32 | 18.29 |
| 8P | 17.78 | 22.86 | 20.83 |
| 9P | 20.32 | 25.40 | 23.37 |
| 10P | 22.86 | 27.94 | 25.91 |
| 11P | 25.40 | 30.48 | 28.45 |
| 12P | 27.94 | 33.02 | 30.99 |
| 13P | 30.48 | 35.56 | 33.53 |
| 14P | 33.02 | 38.10 | 36.07 |
| 15P | 35.56 | 40.64 | 38.61 |
| 16P | 38.10 | 43.18 | 41.15 |
| 17P | 40.64 | 45.72 | 43.69 |
| 18P | 43.18 | 48.26 | 46.23 |
| 19P | 45.72 | 50.80 | 48.77 |
| 20P | 48.26 | 53.34 | 51.31 |
| 21P | 50.80 | 55.88 | 53.85 |
| 22P | 53.34 | 58.42 | 56.39 |
| 23P | 55.88 | 60.96 | 58.93 |
| 24P | 58.42 | 63.50 | 61.47 |
| 25P | 60.96 | 66.04 | 64.01 |

Unit: mm

A2547WVF-XP

2.54mm Pitch 180° Wafer

Reference Informations:

- *Material: Pin: Brass/Tin over Nickel
Insulator: PBT, UL94V-0
- *Mates with CJT A2549HD-XP series Single Row Housing
- *Color: Black

Ordering Information:

A2547WVF-XP - *** - ***
1 2 3

- Part No.
- Material:
(Blank): PBT, UL94V-0
6T: Nylon 6T, UL94V-0
GWT: PBT, UL94V-0, GWT 750°C
- Finish:
(Blank): Tin over Nickel
G: Gold-flash
G15: 15µin (0.38µm) MIN. Select Gold (Mating Area)
100µin (2.54µm) MIN. Select Tin
G30: 30µin (0.76µm) MIN. Select Gold (Mating Area)
100µin (2.54µm) MIN. Select Tin

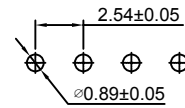

P.C.B LAYOUT

Ordering Information & Dimensions:

| PART NO. | Dimensions | | |
|----------|------------|-------|-------|
| | A | B | C |
| 3P | 5.08 | 10.16 | 8.13 |
| 4P | 7.62 | 12.70 | 10.67 |
| 5P | 10.16 | 15.24 | 13.21 |
| 6P | 12.70 | 17.78 | 15.75 |
| 7P | 15.24 | 20.32 | 18.29 |
| 8P | 17.78 | 22.86 | 20.83 |
| 9P | 20.32 | 25.40 | 23.37 |
| 10P | 22.86 | 27.94 | 25.91 |
| 11P | 25.40 | 30.48 | 28.45 |
| 12P | 27.94 | 33.02 | 30.99 |
| 13P | 30.48 | 35.56 | 33.53 |
| 14P | 33.02 | 38.10 | 36.07 |
| 15P | 35.56 | 40.64 | 38.61 |
| 16P | 38.10 | 43.18 | 41.15 |
| 17P | 40.64 | 45.72 | 43.69 |
| 18P | 43.18 | 48.26 | 46.23 |
| 19P | 45.72 | 50.80 | 48.77 |
| 20P | 48.26 | 53.34 | 51.31 |
| 21P | 50.80 | 55.88 | 53.85 |
| 22P | 53.34 | 58.42 | 56.39 |
| 23P | 55.88 | 60.96 | 58.93 |
| 24P | 58.42 | 63.50 | 61.47 |
| 25P | 60.96 | 66.04 | 64.01 |

Unit: mm

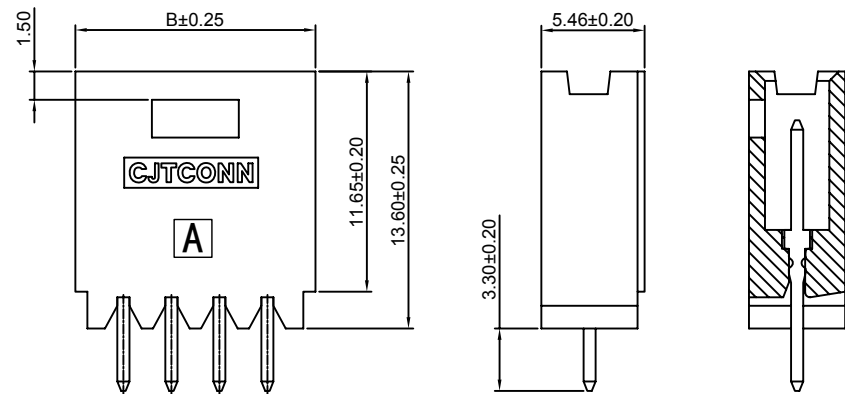
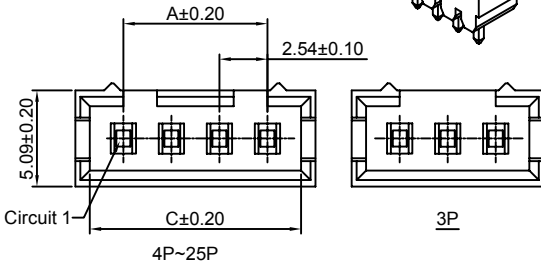

A2547WRF-XP

2.54mm Pitch 90° Wafer

Reference Informations:

- *Material: Pin: Brass/Tin over Nickel
Insulator: PBT, UL94V-0
- *Mates with CJT A2549HD-XP series Single Row Housing
- *Color: Black

Ordering Information:

A2547WRF-XP - *** - ***
1 2 3

- Part No.
- Material:
(Blank): PBT, UL94V-0
6T: Nylon 6T, UL94V-0
GWT: PBT, UL94V-0, GWT 750°C
- Finish:
(Blank): Tin over Nickel
G: Gold-flash
G15: 15µin (0.38µm) MIN. Select Gold (Mating Area)
100µin (2.54µm) MIN. Select Tin
G30: 30µin (0.76µm) MIN. Select Gold (Mating Area)
100µin (2.54µm) MIN. Select Tin

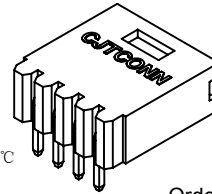

Ordering Information & Dimensions:

| PART NO. | Dimensions | | |
|----------|------------|-------|-------|
| | A | B | C |
| 3P | 5.08 | 10.16 | 8.13 |
| 4P | 7.62 | 12.70 | 10.67 |
| 5P | 10.16 | 15.24 | 13.21 |
| 6P | 12.70 | 17.78 | 15.75 |
| 7P | 15.24 | 20.32 | 18.29 |
| 8P | 17.78 | 22.86 | 20.83 |
| 9P | 20.32 | 25.40 | 23.37 |
| 10P | 22.86 | 27.94 | 25.91 |
| 11P | 25.40 | 30.48 | 28.45 |
| 12P | 27.94 | 33.02 | 30.99 |
| 13P | 30.48 | 35.56 | 33.53 |
| 14P | 33.02 | 38.10 | 36.07 |
| 15P | 35.56 | 40.64 | 38.61 |
| 16P | 38.10 | 43.18 | 41.15 |
| 17P | 40.64 | 45.72 | 43.69 |
| 18P | 43.18 | 48.26 | 46.23 |
| 19P | 45.72 | 50.80 | 48.77 |
| 20P | 48.26 | 53.34 | 51.31 |
| 21P | 50.80 | 55.88 | 53.85 |
| 22P | 53.34 | 58.42 | 56.39 |
| 23P | 55.88 | 60.96 | 58.93 |
| 24P | 58.42 | 63.50 | 61.47 |
| 25P | 60.96 | 66.04 | 64.01 |

Unit: mm

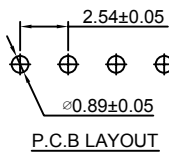
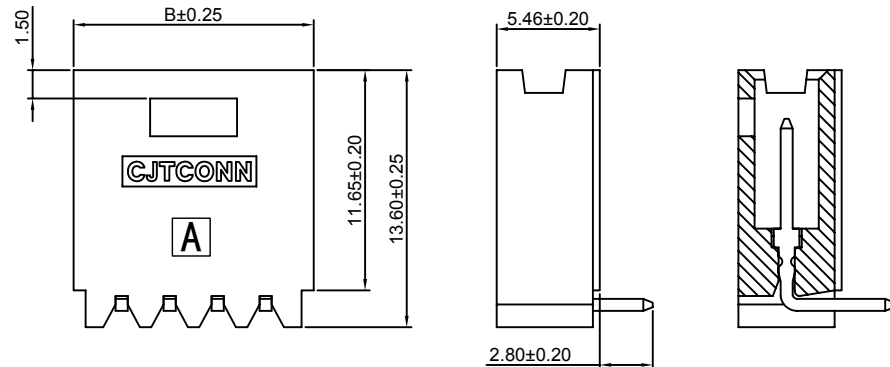
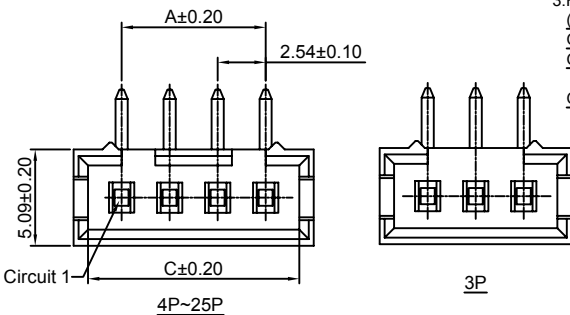

P.C.B LAYOUT

A2547WRE-S-XP

2.54mm Pitch 90° Wafer - SMT TYPE

Reference Informations:

- *Material: Pin: Brass/Tin over Nickel
Insulator: LCP, UL94V-0
- *Mates with CJT A2549H, HA-XP, A2550H-XP-C, A2550H-XP-C1 series Housing
- *Color: Black

Ordering Information:

A2547WRE-S-XP - *** - ***
1 2 3

1. Part No.
2. Material:
(Blank): LCP, UL94V-0
6T: Nylon 6T, UL94V-0
GWT: LCP, UL94V-0, GWT 750°C
3. Finish:
(Blank): Tin over Nickel
G: Gold-flash
G15: 15µm (0.38µm) MIN. Select Gold (Mating Area)
100µm (2.54µm) MIN. Select Tin
G30: 30µm (0.76µm) MIN. Select Gold (Mating Area)
100µm (2.54µm) MIN. Select Tin

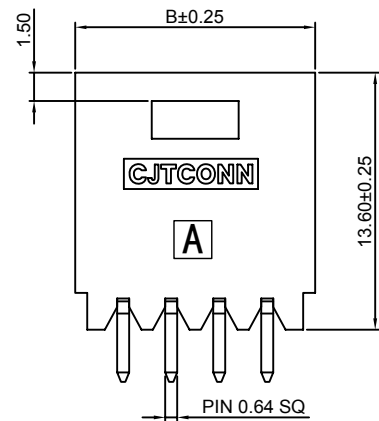

Ordering Information & Dimensions:

| PART NO. | Dimensions | |
|----------|------------|-------|
| | A | B |
| 2P | 2.54 | 7.62 |
| 3P | 5.08 | 10.16 |
| 4P | 7.62 | 12.70 |
| 5P | 10.16 | 15.24 |
| 6P | 12.70 | 17.78 |
| 7P | 15.24 | 20.32 |
| 8P | 17.78 | 22.86 |
| 9P | 20.32 | 25.40 |
| 10P | 22.86 | 27.94 |
| 11P | 25.40 | 30.48 |
| 12P | 27.94 | 33.02 |
| 13P | 30.48 | 35.56 |
| 14P | 33.02 | 38.10 |
| 15P | 35.56 | 40.64 |
| 16P | 38.10 | 43.18 |
| 17P | 40.64 | 45.72 |
| 18P | 43.18 | 48.26 |
| 19P | 45.72 | 50.80 |
| 20P | 48.26 | 53.34 |
| 21P | 50.80 | 55.88 |
| 22P | 53.34 | 58.42 |
| 23P | 55.88 | 60.96 |
| 24P | 58.42 | 63.50 |
| 25P | 60.96 | 66.04 |

Unit: mm

A2547WRF-S-XP

2.54mm Pitch 90° Wafer - SMT TYPE

Reference Informations:

- *Material: Pin: Brass/Tin over Nickel
Insulator: LCP, UL94V-0
- *Mates with CJT A2549HD-XP series Single Row Housing
- *Color: Black

Ordering Information:

A2547WRF-S-XP - *** - ***
1 2 3

1. Part No.
2. Material:
(Blank): LCP, UL94V-0
6T: Nylon 6T, UL94V-0
GWT: LCP, UL94V-0, GWT 750°C
3. Finish:
(Blank): Tin over Nickel
G: Gold-flash
G15: 15µm (0.38µm) MIN. Select Gold (Mating Area)
100µm (2.54µm) MIN. Select Tin
G30: 30µm (0.76µm) MIN. Select Gold (Mating Area)
100µm (2.54µm) MIN. Select Tin



4P~25P

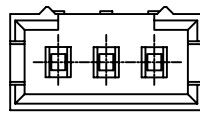

3P

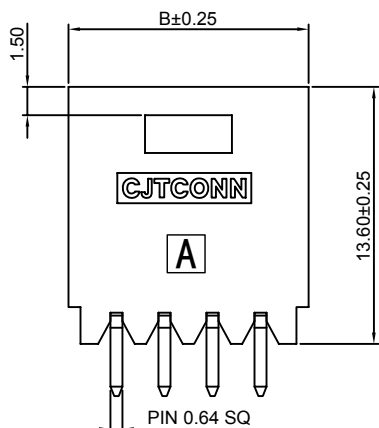

Ordering Information & Dimensions:

| PART NO. | Dimensions | |
|----------|------------|-------|
| | A | B |
| 2P | 2.54 | 7.62 |
| 3P | 5.08 | 10.16 |
| 4P | 7.62 | 12.70 |
| 5P | 10.16 | 15.24 |
| 6P | 12.70 | 17.78 |
| 7P | 15.24 | 20.32 |
| 8P | 17.78 | 22.86 |
| 9P | 20.32 | 25.40 |
| 10P | 22.86 | 27.94 |
| 11P | 25.40 | 30.48 |
| 12P | 27.94 | 33.02 |
| 13P | 30.48 | 35.56 |
| 14P | 33.02 | 38.10 |
| 15P | 35.56 | 40.64 |
| 16P | 38.10 | 43.18 |
| 17P | 40.64 | 45.72 |
| 18P | 43.18 | 48.26 |
| 19P | 45.72 | 50.80 |
| 20P | 48.26 | 53.34 |
| 21P | 50.80 | 55.88 |
| 22P | 53.34 | 58.42 |
| 23P | 55.88 | 60.96 |
| 24P | 58.42 | 63.50 |
| 25P | 60.96 | 66.04 |

Unit: mm

A2547WVB-XP

2.54mm Pitch 180° Box Header

Reference Informations:

- *Material: Pin: Brass/Gold over Nickel
Insulator: PBT, UL94V-0
- *Mates with CJT A2547HJ-XP series
Single Row Housing
- *Color: Black



- Ordering Information:
A2547WVB-XP - *** - ***
- | | | |
|---|---|---|
| 1 | 2 | 3 |
|---|---|---|
- Part No.
 - Material:
(Blank): PBT, UL94V-0
6T: Nylon 6T, UL94V-0
GWT: PBT, UL94V-0, GWT 750 °C
 - Finish:
(Blank): Gold-flash
G15: 15µin (0.38µm) MIN. Select Gold (Mating Area)
100µin (2.54µm) MIN. Select Tin
G30: 30µin (0.76µm) MIN. Select Gold (Mating Area)
100µin (2.54µm) MIN. Select Tin
I: Tin over Nickel

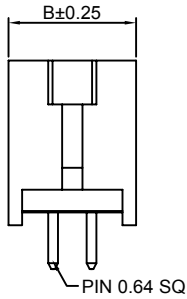
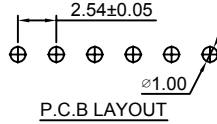
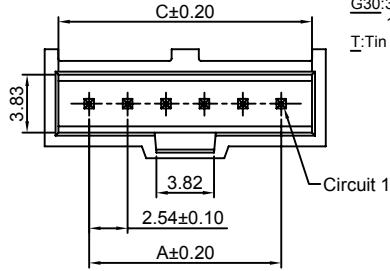

2P~3P

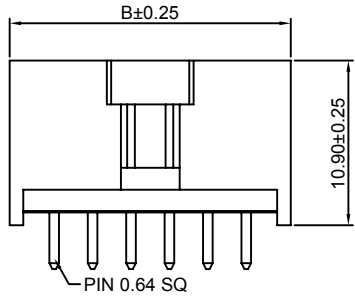

4P~32P

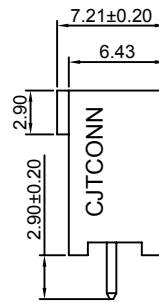

Ordering Information & Dimensions:

| PART NO. | Dimensions | | |
|----------|------------|-------|-------|
| | A | B | C |
| 2P | 2.54 | 8.43 | 6.60 |
| 3P | 5.08 | 10.97 | 9.14 |
| 4P | 7.62 | 13.51 | 11.68 |
| 5P | 10.16 | 16.05 | 14.22 |
| 6P | 12.70 | 18.59 | 16.76 |
| 7P | 15.24 | 21.13 | 19.30 |
| 8P | 17.78 | 23.67 | 21.84 |
| 9P | 20.32 | 26.21 | 24.38 |
| 10P | 22.86 | 28.75 | 26.92 |
| 11P | 25.40 | 31.29 | 29.46 |
| 12P | 27.94 | 33.83 | 32.00 |
| 13P | 30.48 | 36.37 | 34.54 |
| 14P | 33.02 | 38.91 | 37.08 |
| 15P | 35.56 | 41.45 | 39.62 |
| 16P | 38.10 | 43.99 | 42.16 |
| 17P | 40.64 | 46.53 | 44.70 |
| 18P | 43.18 | 49.07 | 47.24 |
| 19P | 45.72 | 51.61 | 49.78 |
| 20P | 48.26 | 54.15 | 52.32 |
| 21P | 50.80 | 56.69 | 54.86 |
| 22P | 53.34 | 59.23 | 57.40 |
| 23P | 55.88 | 61.77 | 59.94 |
| 24P | 58.42 | 64.31 | 62.48 |
| 25P | 60.96 | 66.85 | 65.02 |
| 26P | 63.50 | 69.39 | 67.56 |
| 27P | 66.04 | 71.93 | 70.10 |
| 28P | 68.58 | 74.47 | 72.64 |
| 29P | 71.12 | 77.01 | 75.18 |
| 30P | 73.66 | 79.55 | 77.72 |
| 31P | 76.20 | 82.09 | 80.26 |
| 32P | 78.74 | 84.63 | 82.80 |

Unit: mm

A2547WRB-XP

2.54mm Pitch 90° Box Header

Reference Informations:

- *Material: Pin: Brass/Gold over Nickel
Insulator: PBT, UL94V-0
- *Mates with CJT A2547HJ-XP series Single Row Housing
- *Color: Black

Ordering Information:

A2547WRB-XP - *** - ***
1 2 3

- Part No.
- Material:
(Blank): PBT, UL94V-0
6T: Nylon 6T, UL94V-0
GWT: PBT, UL94V-0, GWT 750 °C
- Finish:
(Blank): Gold-flash
G15: 15µin (0.38µm) MIN. Select Gold (Mating Area)
100µin (2.54µm) MIN. Select Tin
G30: 30µin (0.76µm) MIN. Select Gold (Mating Area)
100µin (2.54µm) MIN. Select Tin
I: Tin over Nickel

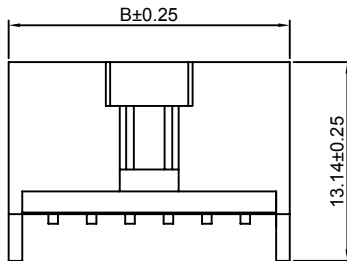
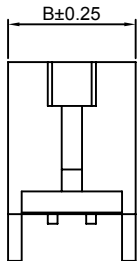
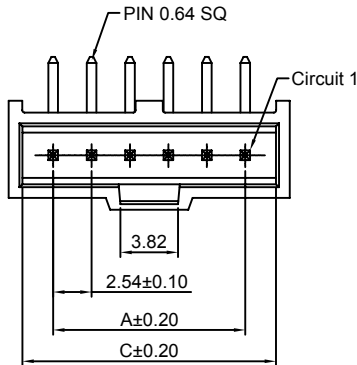
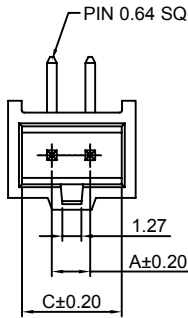

2P~3P

4P~6P

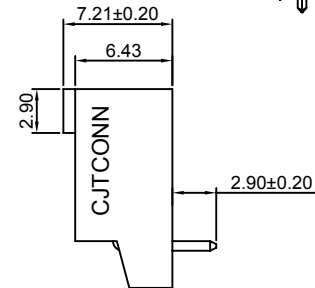
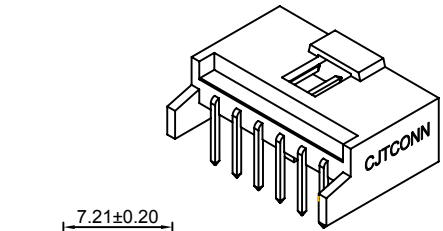

2P~6P

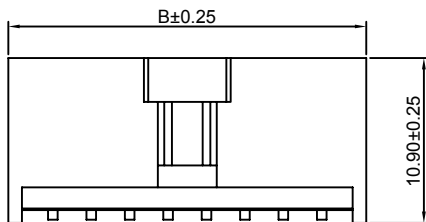
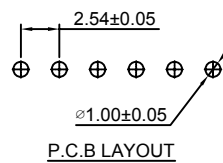

7P~32P

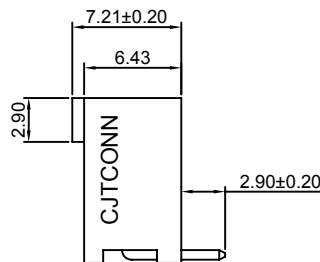

7P~32P

Ordering Information & Dimensions:

| PART NO. | Dimensions | | |
|----------|------------|-------|-------|
| | A | B | C |
| 2P | 2.54 | 8.43 | 6.60 |
| 3P | 5.08 | 10.97 | 9.14 |
| 4P | 7.62 | 13.51 | 11.68 |
| 5P | 10.16 | 16.05 | 14.22 |
| 6P | 12.70 | 18.59 | 16.76 |
| 7P | 15.24 | 21.13 | 19.30 |
| 8P | 17.78 | 23.67 | 21.84 |
| 9P | 20.32 | 26.21 | 24.38 |
| 10P | 22.86 | 28.75 | 26.92 |
| 11P | 25.40 | 31.29 | 29.46 |
| 12P | 27.94 | 33.83 | 32.00 |
| 13P | 30.48 | 36.37 | 34.54 |
| 14P | 33.02 | 38.91 | 37.08 |
| 15P | 35.56 | 41.45 | 39.62 |
| 16P | 38.10 | 43.99 | 42.16 |
| 17P | 40.64 | 46.53 | 44.70 |
| 18P | 43.18 | 49.07 | 47.24 |
| 19P | 45.72 | 51.61 | 49.78 |
| 20P | 48.26 | 54.15 | 52.32 |
| 21P | 50.80 | 56.69 | 54.86 |
| 22P | 53.34 | 59.23 | 57.40 |
| 23P | 55.88 | 61.77 | 59.94 |
| 24P | 58.42 | 64.31 | 62.48 |
| 25P | 60.96 | 66.85 | 65.02 |
| 26P | 63.50 | 69.39 | 67.56 |
| 27P | 66.04 | 71.93 | 70.10 |
| 28P | 68.58 | 74.47 | 72.64 |
| 29P | 71.12 | 77.01 | 75.18 |
| 30P | 73.66 | 79.55 | 77.72 |
| 31P | 76.20 | 82.09 | 80.26 |
| 32P | 78.74 | 84.63 | 82.80 |

Unit: mm

A2547WV-2xXP

2.54mm Pitch 180° Box Header

Reference Informations:

- *Material: Pin: Brass/Gold over Nickel
Insulator: PBT, UL94V-0
- *Mates with CJT A2547H, HA, HB, HC, HF, HG, HK, HS-2xXP series Dual row Housing
- *Color: Black



- Ordering Information:
A2547WV-2xXP - ^{***} - ^{***} - ^{***} - ^{***} - ^{***}
- Part No.
 - Material:
(blank): PBT, UL94V-0
6T: Nylon 6T, UL94V-0
GWT: PBT, UL94V-0, GWT 750 °C
 - Finish:
(blank): Gold-flash
G15: 15µin (0.38µm) MIN. Select Gold (Mating Area)
100µin (2.54µm) MIN. Select Tin
G30: 30µin (0.76µm) MIN. Select Gold (Mating Area)
100µin (2.54µm) MIN. Select Tin
T: Tin over Nickel
 - Color:
(blank): Black
GY: Gray
 - Size(L):
(blank): 14.35mm
L: 10.50mm

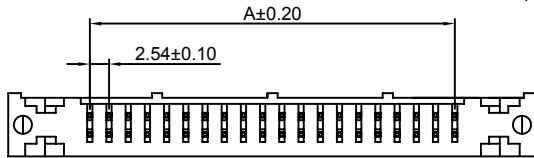

Ordering Information & Dimensions:

| PART NO. | Dimensions | | |
|----------|------------|--------|-------|
| | A | B | C |
| 2x5P | 10.16 | 32.00 | 18.22 |
| 2x6P | 12.70 | 34.54 | 20.76 |
| 2x7P | 15.24 | 37.08 | 23.30 |
| 2x8P | 17.78 | 39.62 | 25.84 |
| 2x9P | 20.32 | 42.16 | 28.38 |
| 2x10P | 22.86 | 44.70 | 30.92 |
| 2x11P | 25.40 | 47.24 | 33.46 |
| 2x12P | 27.94 | 49.78 | 36.00 |
| 2x13P | 30.48 | 52.32 | 38.54 |
| 2x14P | 33.02 | 54.86 | 41.08 |
| 2x15P | 35.56 | 57.40 | 43.62 |
| 2x16P | 38.10 | 59.94 | 46.16 |
| 2x17P | 40.64 | 62.48 | 48.70 |
| 2x18P | 43.18 | 65.02 | 51.24 |
| 2x19P | 45.72 | 67.56 | 53.78 |
| 2x20P | 48.26 | 70.10 | 56.32 |
| 2x21P | 50.80 | 72.64 | 58.86 |
| 2x22P | 53.34 | 75.18 | 61.40 |
| 2x23P | 55.88 | 77.72 | 63.94 |
| 2x24P | 58.42 | 80.26 | 66.48 |
| 2x25P | 60.96 | 82.80 | 69.02 |
| 2x26P | 63.50 | 85.34 | 71.56 |
| 2x27P | 66.04 | 87.88 | 74.10 |
| 2x28P | 68.58 | 90.42 | 76.64 |
| 2x29P | 71.12 | 92.96 | 79.18 |
| 2x30P | 73.66 | 95.50 | 81.72 |
| 2x31P | 76.20 | 98.04 | 84.26 |
| 2x32P | 78.74 | 100.58 | 86.80 |

Unit: mm

A2547WR-2xXP

2.54mm Pitch 90° Box Header

Reference Informations:

- *Material: Pin: Brass/Gold over Nickel
Insulator: PBT, UL94V-0
- *Mates with CJT A2547H, HA, HB, HC, HF, HG, HK, HS-2xXP series Dual row Housing
- *Color: Black



- Ordering Information:
A2547WR-2xXP - ^{***} - ^{***} - ^{***} - ^{***} - ^{***}
- Part No.
 - Material:
(blank): PBT, UL94V-0
6T: Nylon 6T, UL94V-0
GWT: PBT, UL94V-0, GWT 750 °C
 - Finish:
(blank): Gold-flash
G15: 15µin (0.38µm) MIN. Select Gold (Mating Area)
100µin (2.54µm) MIN. Select Tin
G30: 30µin (0.76µm) MIN. Select Gold (Mating Area)
100µin (2.54µm) MIN. Select Tin
T: Tin over Nickel
 - Color:
(blank): Black
GY: Gray
 - Size(L):
(blank): 14.35mm
L: 10.50mm

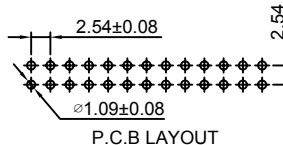
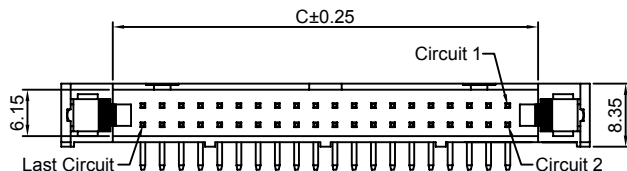
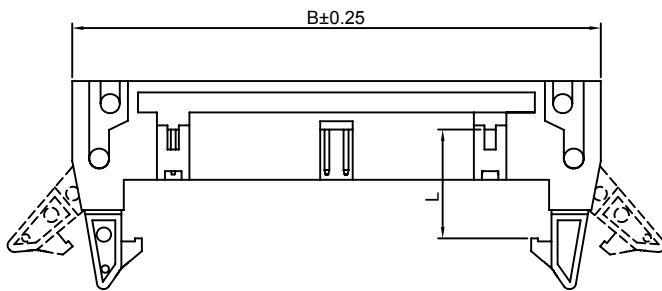
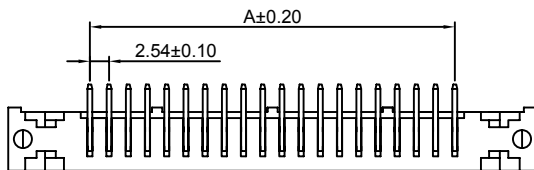

Ordering Information & Dimensions:

| PART NO. | Dimensions | | |
|----------|------------|--------|-------|
| | A | B | C |
| 2x5P | 10.16 | 32.00 | 18.22 |
| 2x6P | 12.70 | 34.54 | 20.76 |
| 2x7P | 15.24 | 37.08 | 23.30 |
| 2x8P | 17.78 | 39.62 | 25.84 |
| 2x9P | 20.32 | 42.16 | 28.38 |
| 2x10P | 22.86 | 44.70 | 30.92 |
| 2x11P | 25.40 | 47.24 | 33.46 |
| 2x12P | 27.94 | 49.78 | 36.00 |
| 2x13P | 30.48 | 52.32 | 38.54 |
| 2x14P | 33.02 | 54.86 | 41.08 |
| 2x15P | 35.56 | 57.40 | 43.62 |
| 2x16P | 38.10 | 59.94 | 46.16 |
| 2x17P | 40.64 | 62.48 | 48.70 |
| 2x18P | 43.18 | 65.02 | 51.24 |
| 2x19P | 45.72 | 67.56 | 53.78 |
| 2x20P | 48.26 | 70.10 | 56.32 |
| 2x21P | 50.80 | 72.64 | 58.86 |
| 2x22P | 53.34 | 75.18 | 61.40 |
| 2x23P | 55.88 | 77.72 | 63.94 |
| 2x24P | 58.42 | 80.26 | 66.48 |
| 2x25P | 60.96 | 82.80 | 69.02 |
| 2x26P | 63.50 | 85.34 | 71.56 |
| 2x27P | 66.04 | 87.88 | 74.10 |
| 2x28P | 68.58 | 90.42 | 76.64 |
| 2x29P | 71.12 | 92.96 | 79.18 |
| 2x30P | 73.66 | 95.50 | 81.72 |
| 2x31P | 76.20 | 98.04 | 84.26 |
| 2x32P | 78.74 | 100.58 | 86.80 |

Unit: mm

A2547WVA-2xXP

2.54mm Pitch 180° Box Header

Reference Informations:

- *Material: Pin: Brass/Gold over Nickel
Insulator: PBT, UL94V-0
- *Mates with CJT A2547HD, HSA-2xXP series Dual row Housing
- *Color: Black

Ordering Information:
A2547WVA-2xXP - *** - *** - *
1 2 3 4

- Part No.
- Material:
(blank): PBT, UL94V-0
6T: Nylon 6T, UL94V-0
GWT: PBT, UL94V-0, GWT 750 °C
- Finish:
(blank): Gold-flash
G15: 15µm (0.38µm) MIN. Select Gold (Mating Area)
100µm (2.54µm) MIN. Select Tin
G30: 30µm (0.76µm) MIN. Select Gold (Mating Area)
100µm (2.54µm) MIN. Select Tin
T: Tin over Nickel
- Size(L):
(blank): 14.35mm
L: 10.50mm

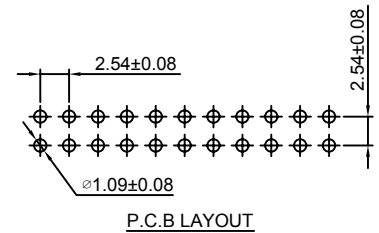
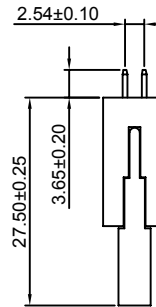
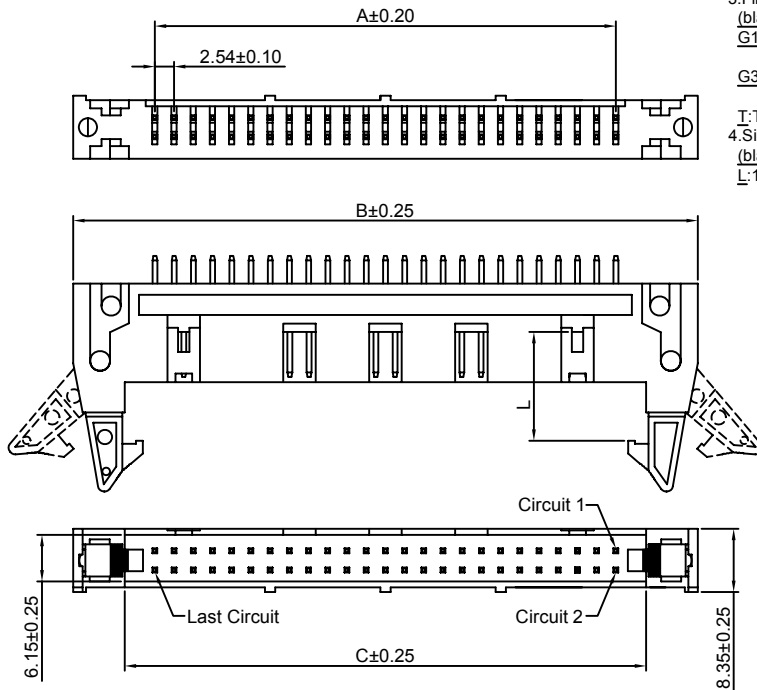
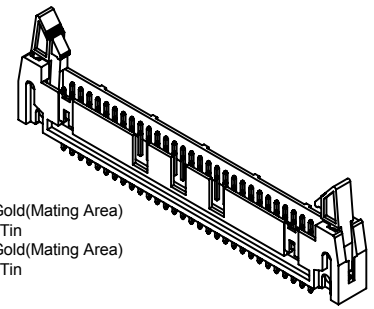

Ordering Information & Dimensions:

| PART NO. | Dimensions | | |
|----------|------------|--------|-------|
| | A | B | C |
| 2x25P | 60.96 | 82.80 | 69.02 |
| 2x30P | 73.66 | 95.50 | 81.72 |
| 2x32P | 78.74 | 100.58 | 86.80 |

Unit: mm

A2547WRA-2xXP

2.54mm Pitch 90° Box Header

Reference Informations:

- *Material: Pin: Brass/Gold over Nickel
Insulator: PBT, UL94V-0
- *Mates with CJT A2547HD, HSA-2xXP series Dual row Housing
- *Color: Black

Ordering Information:
A2547WRA-2xXP - *** - *** - *
1 2 3 4

- Part No.
- Material:
(Blank): PBT, UL94V-0
6T: Nylon 6T, UL94V-0
GWT: PBT, UL94V-0, GWT 750 °C
- Finish:
(blank): Gold-flash
G15: 15µm (0.38µm) MIN. Select Gold (Mating Area)
100µm (2.54µm) MIN. Select Tin
G30: 30µm (0.76µm) MIN. Select Gold (Mating Area)
100µm (2.54µm) MIN. Select Tin
T: Tin over Nickel
- Size(L):
(blank): 14.35mm
L: 10.50mm

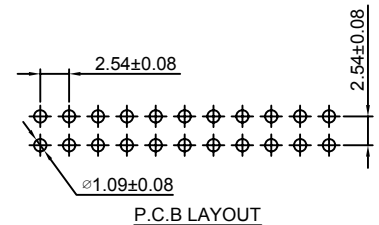
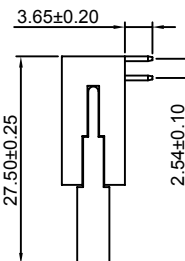
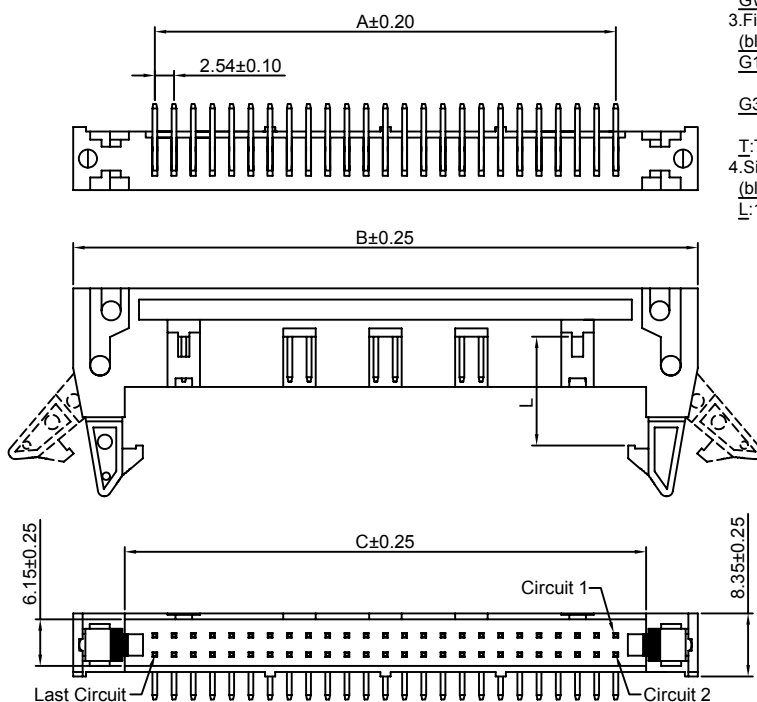
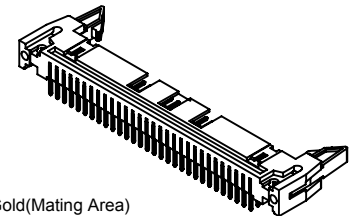

Ordering Information & Dimensions:

| PART NO. | Dimensions | | |
|----------|------------|--------|-------|
| | A | B | C |
| 2x25P | 60.96 | 82.80 | 69.02 |
| 2x30P | 73.66 | 95.50 | 81.72 |
| 2x32P | 78.74 | 100.58 | 86.80 |

Unit: mm

A2547WVB-2xXP

2.54mm Pitch 180° Box Header

Reference Informations:

- *Material: Pin: Brass/Gold over Nickel
Insulator: PBT, UL94V-0
- *Mates with CJT A2547HJ-2xXP series Housing
- *Color: Black

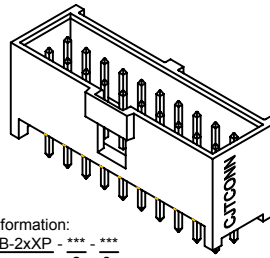
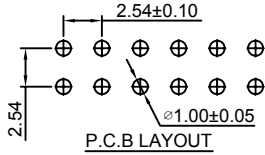

Ordering Information:
A2547WVB-2xXP - *** - ***

1. Part No.
2. Material:
(Blank): PBT, UL94V-0
6T: Nylon 6T, UL94V-0
GWT: PBT, UL94V-0, GWT 750 °C
3. Finish:
(Blank): Gold-flash
G15: 15µin (0.38µm) MIN. Select Gold (Mating Area)
100µin (2.54µm) MIN. Select Tin
G30: 30µin (0.76µm) MIN. Select Gold (Mating Area)
100µin (2.54µm) MIN. Select Tin
T: Tin over Nickel

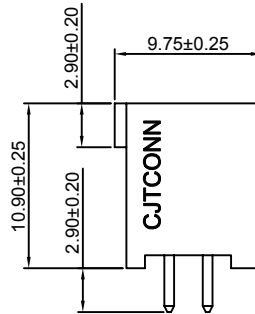
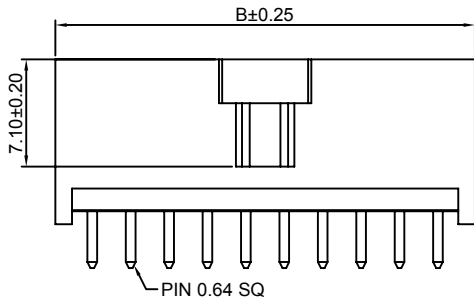
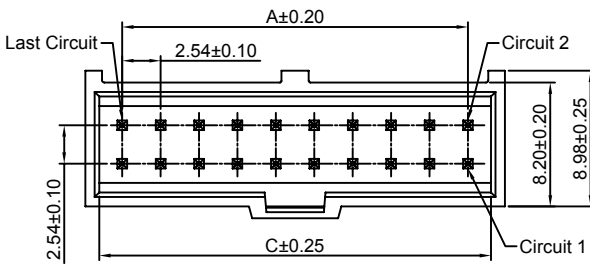

Ordering Information & Dimensions:

| PART NO. | Dimensions | | |
|----------|------------|-------|-------|
| | A | B | C |
| 2x3P | 5.08 | 9.96 | 8.12 |
| 2x4P | 7.62 | 12.50 | 10.66 |
| 2x5P | 10.16 | 15.04 | 13.20 |
| 2x6P | 12.70 | 17.58 | 15.74 |
| 2x7P | 15.24 | 20.12 | 18.28 |
| 2x8P | 17.78 | 22.66 | 20.82 |
| 2x9P | 20.32 | 25.20 | 23.36 |
| 2x10P | 22.86 | 27.74 | 25.90 |
| 2x11P | 25.40 | 30.28 | 28.44 |
| 2x12P | 27.94 | 32.82 | 30.98 |
| 2x13P | 30.48 | 35.36 | 33.52 |
| 2x14P | 33.02 | 37.90 | 36.06 |
| 2x15P | 35.56 | 40.44 | 38.60 |
| 2x16P | 38.10 | 42.98 | 41.14 |
| 2x17P | 40.64 | 45.52 | 43.68 |
| 2x18P | 43.18 | 48.06 | 46.22 |
| 2x19P | 45.72 | 50.60 | 48.76 |
| 2x20P | 48.26 | 53.14 | 51.30 |
| 2x21P | 50.80 | 55.68 | 53.84 |
| 2x22P | 53.34 | 58.22 | 56.38 |
| 2x23P | 55.88 | 60.76 | 58.92 |
| 2x24P | 58.42 | 63.30 | 61.46 |
| 2x25P | 60.96 | 65.84 | 64.00 |
| 2x26P | 63.50 | 68.38 | 66.54 |
| 2x27P | 66.04 | 70.92 | 69.08 |
| 2x28P | 68.58 | 73.46 | 71.62 |
| 2x29P | 71.12 | 76.00 | 74.16 |
| 2x30P | 73.66 | 78.54 | 76.70 |
| 2x31P | 76.20 | 81.08 | 79.24 |
| 2x32P | 78.74 | 83.62 | 81.78 |

Unit: mm

A2547WRB-2xXP

2.54mm Pitch 90° Box Header

Reference Informations:

- *Material: Pin: Brass/Gold over Nickel
Insulator: PBT, UL94V-0
- *Mates with CJT A2547HJ-2xXP series Housing
- *Color: Black

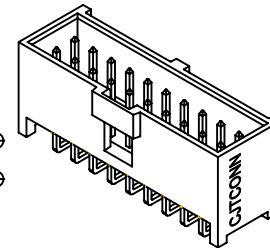
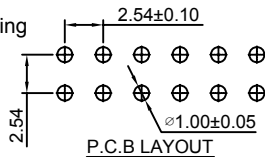

Ordering Information:
A2547WRB-2xXP - *** - ***

1. Part No.
2. Material:
(Blank): PBT, UL94V-0
6T: Nylon 6T, UL94V-0
GWT: PBT, UL94V-0, GWT 750 °C
3. Finish:
(Blank): Gold-flash
G15: 15µin (0.38µm) MIN. Select Gold (Mating Area)
100µin (2.54µm) MIN. Select Tin
G30: 30µin (0.76µm) MIN. Select Gold (Mating Area)
100µin (2.54µm) MIN. Select Tin
T: Tin over Nickel

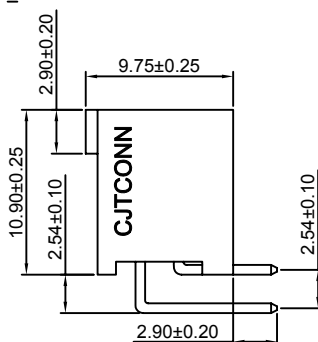
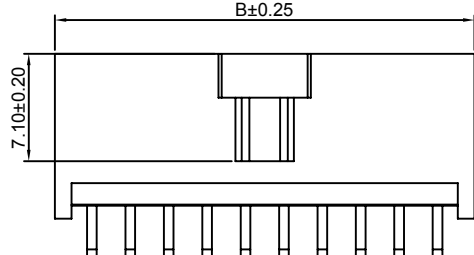
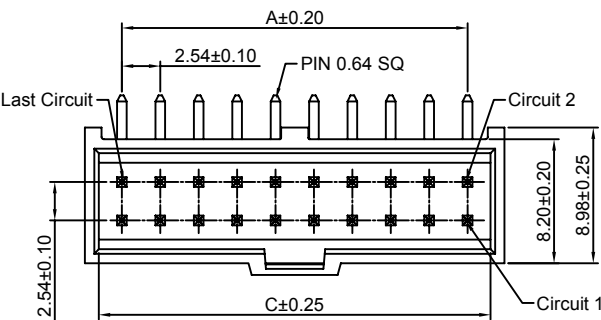

Ordering Information & Dimensions:

| PART NO. | Dimensions | | |
|----------|------------|-------|-------|
| | A | B | C |
| 2x3P | 5.08 | 9.96 | 8.12 |
| 2x4P | 7.62 | 12.50 | 10.66 |
| 2x5P | 10.16 | 15.04 | 13.20 |
| 2x6P | 12.70 | 17.58 | 15.74 |
| 2x7P | 15.24 | 20.12 | 18.28 |
| 2x8P | 17.78 | 22.66 | 20.82 |
| 2x9P | 20.32 | 25.20 | 23.36 |
| 2x10P | 22.86 | 27.74 | 25.90 |
| 2x11P | 25.40 | 30.28 | 28.44 |
| 2x12P | 27.94 | 32.82 | 30.98 |
| 2x13P | 30.48 | 35.36 | 33.52 |
| 2x14P | 33.02 | 37.90 | 36.06 |
| 2x15P | 35.56 | 40.44 | 38.60 |
| 2x16P | 38.10 | 42.98 | 41.14 |
| 2x17P | 40.64 | 45.52 | 43.68 |
| 2x18P | 43.18 | 48.06 | 46.22 |
| 2x19P | 45.72 | 50.60 | 48.76 |
| 2x20P | 48.26 | 53.14 | 51.30 |
| 2x21P | 50.80 | 55.68 | 53.84 |
| 2x22P | 53.34 | 58.22 | 56.38 |
| 2x23P | 55.88 | 60.76 | 58.92 |
| 2x24P | 58.42 | 63.30 | 61.46 |
| 2x25P | 60.96 | 65.84 | 64.00 |
| 2x26P | 63.50 | 68.38 | 66.54 |
| 2x27P | 66.04 | 70.92 | 69.08 |
| 2x28P | 68.58 | 73.46 | 71.62 |
| 2x29P | 71.12 | 76.00 | 74.16 |
| 2x30P | 73.66 | 78.54 | 76.70 |
| 2x31P | 76.20 | 81.08 | 79.24 |
| 2x32P | 78.74 | 83.62 | 81.78 |

Unit: mm

A2547WVB-2xXP-A

2.54mm Pitch 180° Box Header - VERSION WITH VOIDS

Reference Informations:

- *Material: Pin: Brass/Gold over Nickel
Insulator: PBT, UL94V-0
- *Mates with CJT A2547HJ-2xXP series Housing
- *Color: Black

Ordering Information:

A2547WVB-2xXP-A - *** - ***
1 2 3

- Part No.
- Material:
(Blank): PBT, UL94V-0
6T: Nylon 6T, UL94V-0
GWT: PBT, UL94V-0 GWT 750 °C
- Finish:
(Blank): Gold-flash
G15: 15µm (0.38µm) MIN. Select Gold (Mating Area)
100µm (2.54µm) MIN. Select Tin
G30: 30µm (0.76µm) MIN. Select Gold (Mating Area)
100µm (2.54µm) MIN. Select Tin
T: Tin over Nickel

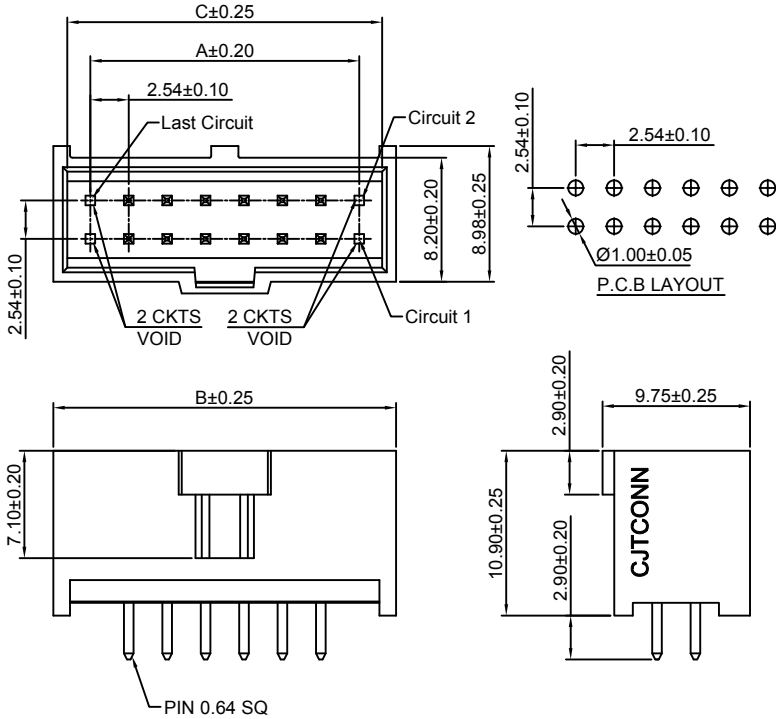
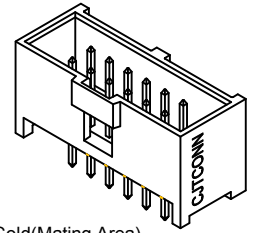

Ordering Information & Dimensions:

| PART NO. | Dimensions | | | PART NO. | Dimensions | | |
|----------|------------|-------|-------|----------|------------|-------|-------|
| | A | B | C | | A | B | C |
| 2x3P | --- | 9.96 | 8.12 | 2x18P | 38.10 | 48.06 | 46.22 |
| 2x4P | 2.54 | 12.50 | 10.66 | 2x19P | 40.64 | 50.60 | 48.76 |
| 2x5P | 5.08 | 15.04 | 13.20 | 2x20P | 43.18 | 53.14 | 51.30 |
| 2x6P | 7.62 | 17.58 | 15.74 | 2x21P | 45.72 | 55.68 | 53.84 |
| 2x7P | 10.16 | 20.12 | 18.28 | 2x22P | 48.26 | 58.22 | 56.38 |
| 2x8P | 12.70 | 22.66 | 20.82 | 2x23P | 50.80 | 60.76 | 58.92 |
| 2x9P | 15.24 | 25.20 | 23.36 | 2x24P | 53.34 | 63.30 | 61.46 |
| 2x10P | 17.78 | 27.74 | 25.90 | 2x25P | 55.88 | 65.84 | 64.00 |
| 2x11P | 20.32 | 30.28 | 28.44 | 2x26P | 58.42 | 68.38 | 66.54 |
| 2x12P | 22.86 | 32.82 | 30.98 | 2x27P | 60.96 | 70.92 | 69.08 |
| 2x13P | 25.40 | 35.36 | 33.52 | 2x28P | 63.50 | 73.46 | 71.62 |
| 2x14P | 27.94 | 37.90 | 36.06 | 2x29P | 66.04 | 76.00 | 74.16 |
| 2x15P | 30.48 | 40.44 | 38.60 | 2x30P | 68.58 | 78.54 | 76.70 |
| 2x16P | 33.02 | 42.98 | 41.14 | 2x31P | 71.12 | 81.08 | 79.24 |
| 2x17P | 35.56 | 45.52 | 43.68 | 2x32P | 73.66 | 83.62 | 81.78 |

Unit: mm

A2547WRB-2xXP-A

2.54mm Pitch 90° Box Header - VERSION WITH VOIDS

Reference Informations:

- *Material: Pin: Brass/Gold over Nickel
Insulator: PBT, UL94V-0
- *Mates with CJT A2547HJ-2xXP series Housing
- *Color: Black

Ordering Information:

A2547WRB-2xXP-A - *** - ***
1 2 3

- Part No.
- Material:
(Blank): PBT, UL94V-0
6T: Nylon 6T, UL94V-0
GWT: PBT, UL94V-0, GWT 750 °C
- Finish:
(Blank): Gold-flash
G15: 15µm (0.38µm) MIN. Select Gold (Mating Area)
100µm (2.54µm) MIN. Select Tin
G30: 30µm (0.76µm) MIN. Select Gold (Mating Area)
100µm (2.54µm) MIN. Select Tin
T: Tin over Nickel

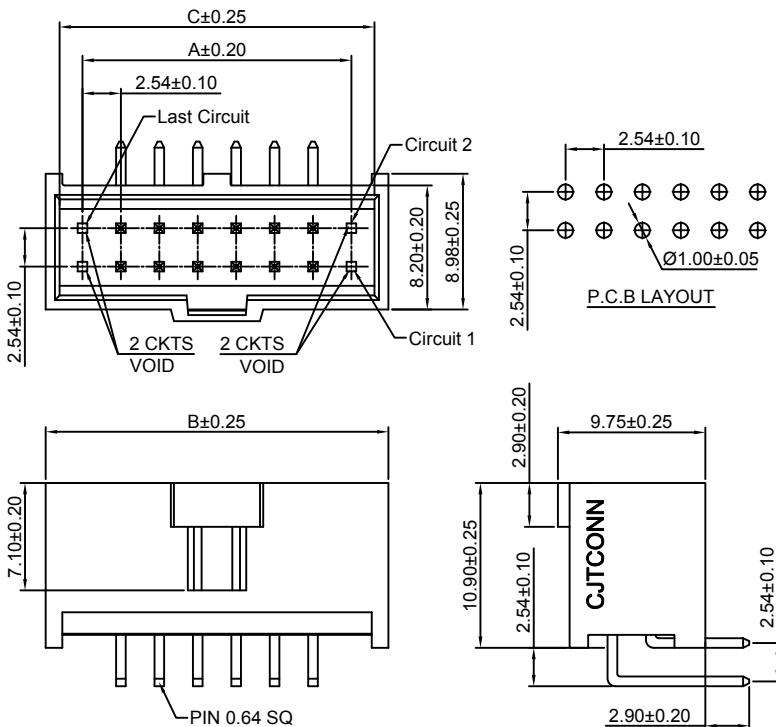
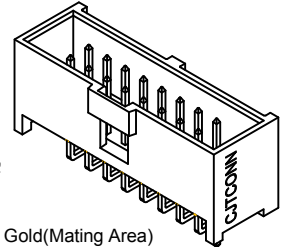

Ordering Information & Dimensions:

| PART NO. | Dimensions | | | PART NO. | Dimensions | | |
|----------|------------|-------|-------|----------|------------|-------|-------|
| | A | B | C | | A | B | C |
| 2x3P | --- | 9.96 | 8.12 | 2x18P | 38.10 | 48.06 | 46.22 |
| 2x4P | 2.54 | 12.50 | 10.66 | 2x19P | 40.64 | 50.60 | 48.76 |
| 2x5P | 5.08 | 15.04 | 13.20 | 2x20P | 43.18 | 53.14 | 51.30 |
| 2x6P | 7.62 | 17.58 | 15.74 | 2x21P | 45.72 | 55.68 | 53.84 |
| 2x7P | 10.16 | 20.12 | 18.28 | 2x22P | 48.26 | 58.22 | 56.38 |
| 2x8P | 12.70 | 22.66 | 20.82 | 2x23P | 50.80 | 60.76 | 58.92 |
| 2x9P | 15.24 | 25.20 | 23.36 | 2x24P | 53.34 | 63.30 | 61.46 |
| 2x10P | 17.78 | 27.74 | 25.90 | 2x25P | 55.88 | 65.84 | 64.00 |
| 2x11P | 20.32 | 30.28 | 28.44 | 2x26P | 58.42 | 68.38 | 66.54 |
| 2x12P | 22.86 | 32.82 | 30.98 | 2x27P | 60.96 | 70.92 | 69.08 |
| 2x13P | 25.40 | 35.36 | 33.52 | 2x28P | 63.50 | 73.46 | 71.62 |
| 2x14P | 27.94 | 37.90 | 36.06 | 2x29P | 66.04 | 76.00 | 74.16 |
| 2x15P | 30.48 | 40.44 | 38.60 | 2x30P | 68.58 | 78.54 | 76.70 |
| 2x16P | 33.02 | 42.98 | 41.14 | 2x31P | 71.12 | 81.08 | 79.24 |
| 2x17P | 35.56 | 45.52 | 43.68 | 2x32P | 73.66 | 83.62 | 81.78 |

Unit: mm

A2547WVB-S-2xXP

2.54mm Pitch 180° Box Header - SMT TYPE

Reference Informations:

- *Material: Pin: Brass/Gold over Nickel
Insulator: Nylon 6T, UL94V-0
- *Mates with CJT A2547HJ-2xXP series Dual row Housing
- *Color: Black

Odering Information:
A2547WVB-S-2xXP - *** - ***
1 2 3

- Part No.
- Material:
(Blank): Nylon 6T, UL94V-0
GWT: Nylon 6T, UL94V-0, GWT 750 °C
- Finish:
(Blank): Gold-flash
G15: 15µin (0.38µm) MIN. Select Gold (Mating Area)
100µin (2.54µm) MIN. Select Tin
G30: 30µin (0.76µm) MIN. Select Gold (Mating Area)
100µin (2.54µm) MIN. Select Tin
T: Tin over Nickel

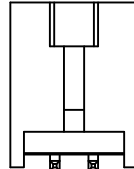
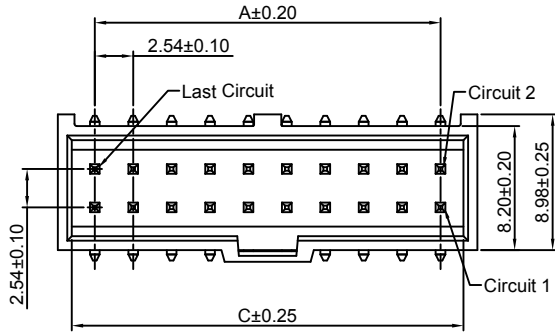
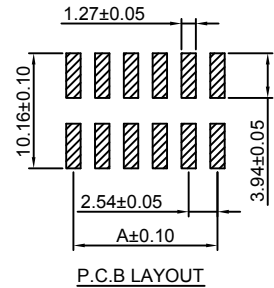

2x2P

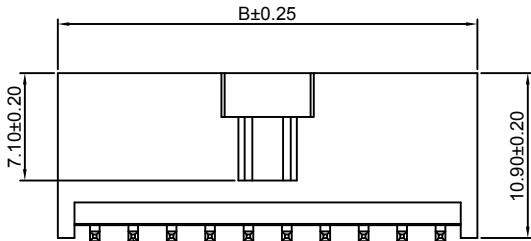

2x3P~2x34P

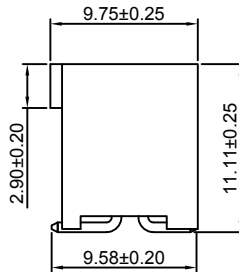

Ordering Information & Dimensions:

| PART NO. | Dimensions | | | PART NO. | Dimensions | | |
|----------|------------|-------|-------|----------|------------|-------|-------|
| | A | B | C | | A | B | C |
| 2x2P | 2.54 | 7.42 | 5.58 | 2x19P | 45.72 | 50.60 | 48.76 |
| 2x3P | 5.08 | 9.96 | 8.12 | 2x20P | 48.26 | 53.14 | 51.30 |
| 2x4P | 7.62 | 12.50 | 10.66 | 2x21P | 50.80 | 55.68 | 53.84 |
| 2x5P | 10.16 | 15.04 | 13.20 | 2x22P | 53.34 | 58.22 | 56.38 |
| 2x6P | 12.70 | 17.58 | 15.74 | 2x23P | 55.88 | 60.76 | 58.92 |
| 2x7P | 15.24 | 20.12 | 18.28 | 2x24P | 58.42 | 63.30 | 61.46 |
| 2x8P | 17.78 | 22.66 | 20.82 | 2x25P | 60.96 | 65.84 | 64.00 |
| 2x9P | 20.32 | 25.20 | 23.36 | 2x26P | 63.50 | 68.38 | 66.54 |
| 2x10P | 22.86 | 27.74 | 25.90 | 2x27P | 66.04 | 70.92 | 69.08 |
| 2x11P | 25.40 | 30.28 | 28.44 | 2x28P | 68.58 | 73.46 | 71.62 |
| 2x12P | 27.94 | 32.82 | 30.98 | 2x29P | 71.12 | 76.00 | 74.16 |
| 2x13P | 30.48 | 35.36 | 33.52 | 2x30P | 73.66 | 78.54 | 76.70 |
| 2x14P | 33.02 | 37.90 | 36.06 | 2x31P | 76.20 | 81.08 | 79.24 |
| 2x15P | 35.56 | 40.44 | 38.60 | 2x32P | 78.74 | 83.62 | 81.78 |
| 2x16P | 38.10 | 42.98 | 41.14 | 2x33P | 81.28 | 86.16 | 84.32 |
| 2x17P | 40.64 | 45.52 | 43.68 | 2x34P | 83.82 | 88.70 | 86.86 |
| 2x18P | 43.18 | 48.06 | 46.22 | | | | |

Unit: mm

A2547WVB-S-2xXP-A

2.54mm Pitch 180° Box Header - SMT TYPE VERSION WITH VOIDS

Reference Informations:

- *Material: Pin: Brass/Gold over Nickel
Insulator: Nylon 6T, UL94V-0
- *Mates with CJT A2547HJ-2xXP series Housing
- *Color: Black

Odering Information:
A2547WVB-S-2xXP-A - *** - ***
1 2 3

- Part No.
- Material:
(Blank): Nylon 6T, UL94V-0
GWT: Nylon 6T, UL94V-0, GWT 750 °C
- Finish:
(Blank): Gold-flash
G15: 15µin (0.38µm) MIN. Select Gold (Mating Area)
100µin (2.54µm) MIN. Select Tin
G30: 30µin (0.76µm) MIN. Select Gold (Mating Area)
100µin (2.54µm) MIN. Select Tin
T: Tin over Nickel

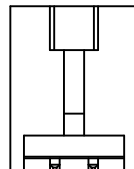
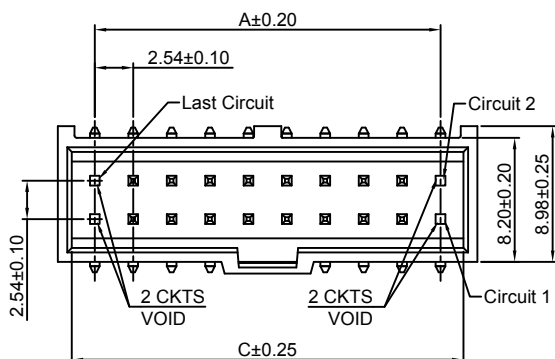
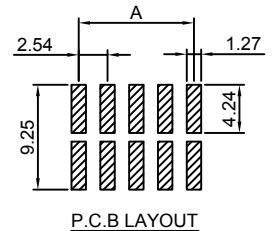

2x2P

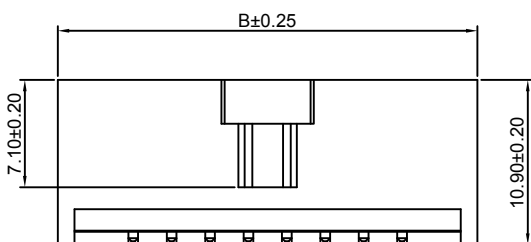

2x3P~2x34P

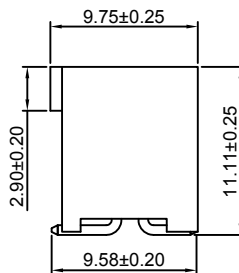

Ordering Information & Dimensions:

| PART NO. | Dimensions | | | PART NO. | Dimensions | | |
|----------|------------|-------|-------|----------|------------|-------|-------|
| | A | B | C | | A | B | C |
| 2x3P | --- | 9.96 | 8.12 | 2x18P | 38.10 | 48.06 | 46.22 |
| 2x4P | 2.54 | 12.50 | 10.66 | 2x19P | 40.64 | 50.60 | 48.76 |
| 2x5P | 5.08 | 15.04 | 13.20 | 2x20P | 43.18 | 53.14 | 51.30 |
| 2x6P | 7.62 | 17.58 | 15.74 | 2x21P | 45.72 | 55.68 | 53.84 |
| 2x7P | 10.16 | 20.12 | 18.28 | 2x22P | 48.26 | 58.22 | 56.38 |
| 2x8P | 12.70 | 22.66 | 20.82 | 2x23P | 50.80 | 60.76 | 58.92 |
| 2x9P | 15.24 | 25.20 | 23.36 | 2x24P | 53.34 | 63.30 | 61.46 |
| 2x10P | 17.78 | 27.74 | 25.90 | 2x25P | 55.88 | 65.84 | 64.00 |
| 2x11P | 20.32 | 30.28 | 28.44 | 2x26P | 58.42 | 68.38 | 66.54 |
| 2x12P | 22.86 | 32.82 | 30.98 | 2x27P | 60.96 | 70.92 | 69.08 |
| 2x13P | 25.40 | 35.36 | 33.52 | 2x28P | 63.50 | 73.46 | 71.62 |
| 2x14P | 27.94 | 37.90 | 36.06 | 2x29P | 66.04 | 76.00 | 74.16 |
| 2x15P | 30.48 | 40.44 | 38.60 | 2x30P | 68.58 | 78.54 | 76.70 |
| 2x16P | 33.02 | 42.98 | 41.14 | 2x31P | 71.12 | 81.08 | 79.24 |
| 2x17P | 35.56 | 45.52 | 43.68 | 2x32P | 73.66 | 83.62 | 81.78 |

Unit: mm

A2547WVC-2xXP

2.54mm Pitch 180° Box Header

Reference Informations:

- *Material: Pin: Brass/Gold over Nickel
Insulator: PBT, UL94V-0
- *Mates with CJT A2547 series Dual row Housing
- *Color: Black

Ordering Information:
A2547WVC-2xXP - *** - ***
1 2 3

- Part No.
- Material:
(Blank): PBT, UL94V-0
6T: Nylon 6T, UL94V-0
GWT: PBT, UL94V-0, GWT 750°C
- Finish:
(Blank): Gold-flash
G15: 15µin (0.38µm) MIN. Select Gold (Mating Area)
100µin (2.54µm) MIN. Select Tin
G30: 30µin (0.76µm) MIN. Select Gold (Mating Area)
100µin (2.54µm) MIN. Select Tin
T: Tin over Nickel

Ordering Information & Dimensions:

| PART NO. | Dimensions | |
|----------|------------|--------|
| | A | B |
| 2x5P | 10.16 | 31.90 |
| 2x6P | 12.70 | 34.44 |
| 2x7P | 15.24 | 36.98 |
| 2x8P | 17.78 | 39.52 |
| 2x9P | 20.32 | 42.06 |
| 2x10P | 22.86 | 44.60 |
| 2x11P | 25.40 | 47.14 |
| 2x12P | 27.94 | 49.68 |
| 2x13P | 30.48 | 52.22 |
| 2x14P | 33.02 | 54.76 |
| 2x15P | 35.56 | 57.30 |
| 2x16P | 38.10 | 59.84 |
| 2x17P | 40.64 | 62.38 |
| 2x18P | 43.18 | 64.92 |
| 2x19P | 45.72 | 67.46 |
| 2x20P | 48.26 | 70.00 |
| 2x21P | 50.80 | 72.54 |
| 2x22P | 53.34 | 75.08 |
| 2x23P | 55.88 | 77.62 |
| 2x24P | 58.42 | 80.16 |
| 2x25P | 60.96 | 82.70 |
| 2x26P | 63.50 | 85.24 |
| 2x27P | 66.04 | 87.78 |
| 2x28P | 68.58 | 90.32 |
| 2x29P | 71.12 | 92.86 |
| 2x30P | 73.66 | 95.40 |
| 2x31P | 76.20 | 97.94 |
| 2x32P | 78.74 | 100.48 |

Unit: mm

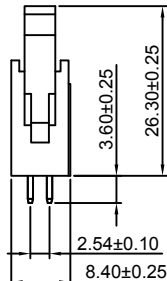
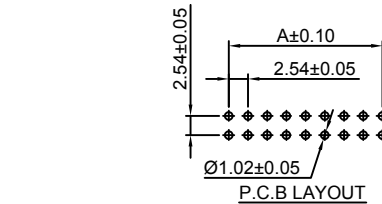
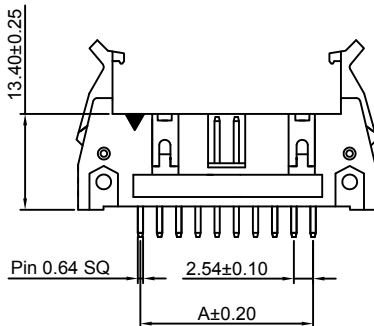
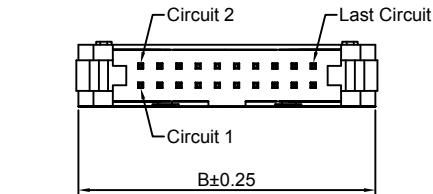

A2547WRC-2xXP

2.54mm Pitch 90° Box Header

Reference Informations:

- *Material: Pin: Brass/Gold over Nickel
Insulator: PBT, UL94V-0
- *Mates with CJT A2547 series Dual row Housing
- *Color: Black

Ordering Information:
A2547WRC-2xXP - *** - ***
1 2 3

- Part No.
- Material:
(Blank): PBT, UL94V-0
6T: Nylon 6T, UL94V-0
GWT: PBT, UL94V-0, GWT 750°C
- Finish:
(Blank): Gold-flash
G15: 15µin (0.38µm) MIN. Select Gold (Mating Area)
100µin (2.54µm) MIN. Select Tin
G30: 30µin (0.76µm) MIN. Select Gold (Mating Area)
100µin (2.54µm) MIN. Select Tin
T: Tin over Nickel

Ordering Information & Dimensions:

| PART NO. | Dimensions | |
|----------|------------|--------|
| | A | B |
| 2x5P | 10.16 | 31.90 |
| 2x6P | 12.70 | 34.44 |
| 2x7P | 15.24 | 36.98 |
| 2x8P | 17.78 | 39.52 |
| 2x9P | 20.32 | 42.06 |
| 2x10P | 22.86 | 44.60 |
| 2x11P | 25.40 | 47.14 |
| 2x12P | 27.94 | 49.68 |
| 2x13P | 30.48 | 52.22 |
| 2x14P | 33.02 | 54.76 |
| 2x15P | 35.56 | 57.30 |
| 2x16P | 38.10 | 59.84 |
| 2x17P | 40.64 | 62.38 |
| 2x18P | 43.18 | 64.92 |
| 2x19P | 45.72 | 67.46 |
| 2x20P | 48.26 | 70.00 |
| 2x21P | 50.80 | 72.54 |
| 2x22P | 53.34 | 75.08 |
| 2x23P | 55.88 | 77.62 |
| 2x24P | 58.42 | 80.16 |
| 2x25P | 60.96 | 82.70 |
| 2x26P | 63.50 | 85.24 |
| 2x27P | 66.04 | 87.78 |
| 2x28P | 68.58 | 90.32 |
| 2x29P | 71.12 | 92.86 |
| 2x30P | 73.66 | 95.40 |
| 2x31P | 76.20 | 97.94 |
| 2x32P | 78.74 | 100.48 |

Unit: mm

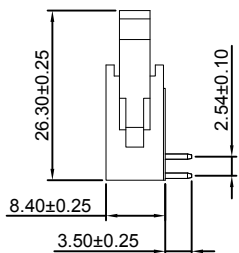
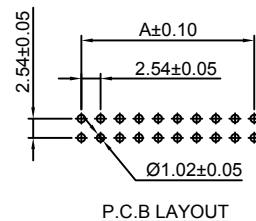
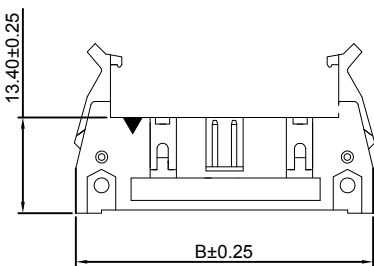

A2547WV-N-2xXP

2.54mm Pitch 180° Dual Row Box Header

Reference Informations:

- *Material: Pin: Brass/Gold over Nickel
Insulator: PBT, UL94V-0
- *Mates with CJT A2541H-N-2xXP, A2541H-N-2xXP-2, A2547HN-2xXP series Dual row Housing
- *Color: Black

Ordering Information:
A2547WV-N-2xXP - *** - ***
1 2 3

1. Part No.
2. Material:
(Blank): PBT, UL94V-0
6T: Nylon 6T, UL94V-0
6WT: PBT, UL94V-0, GWT 750 °C
3. Finish:
(Blank): Gold-flash
G15: 15µm (0.38µm) MIN. Select Gold (Mating Area)
100µm (2.54µm) MIN. Select Tin
G30: 30µm (0.76µm) MIN. Select Gold (Mating Area)
100µm (2.54µm) MIN. Select Tin
T: Tin over Nickel

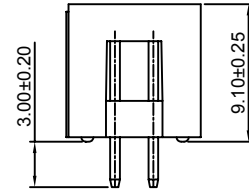
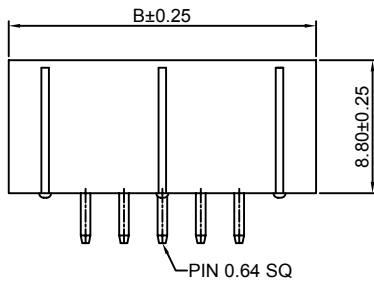
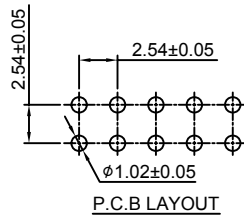
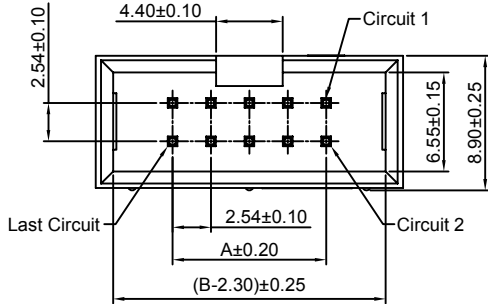

Ordering Information & Dimensions:

| PART NO. | Dimensions | | PART NO. | Dimensions | |
|----------|------------|-------|----------|------------|--------|
| | A | B | | A | B |
| 2x2P | 2.54 | 12.70 | 2x22P | 53.34 | 63.50 |
| 2x3P | 5.08 | 15.24 | 2x23P | 55.88 | 66.04 |
| 2x4P | 7.62 | 17.78 | 2x24P | 58.42 | 68.58 |
| 2x5P | 10.16 | 20.32 | 2x25P | 60.96 | 71.12 |
| 2x6P | 12.70 | 22.86 | 2x26P | 63.50 | 73.66 |
| 2x7P | 15.24 | 25.40 | 2x27P | 66.04 | 76.20 |
| 2x8P | 17.78 | 27.94 | 2x28P | 68.58 | 78.74 |
| 2x9P | 20.32 | 30.48 | 2x29P | 71.12 | 81.28 |
| 2x10P | 22.86 | 33.02 | 2x30P | 73.66 | 83.82 |
| 2x11P | 25.40 | 35.56 | 2x31P | 76.20 | 86.36 |
| 2x12P | 27.94 | 38.10 | 2x32P | 78.74 | 88.90 |
| 2x13P | 30.48 | 40.64 | 2x33P | 81.28 | 91.44 |
| 2x14P | 33.02 | 43.18 | 2x34P | 83.82 | 93.98 |
| 2x15P | 35.56 | 45.72 | 2x35P | 86.36 | 96.52 |
| 2x16P | 38.10 | 48.26 | 2x36P | 88.90 | 99.06 |
| 2x17P | 40.64 | 50.80 | 2x37P | 91.44 | 101.60 |
| 2x18P | 43.18 | 53.34 | 2x38P | 93.98 | 104.14 |
| 2x19P | 45.72 | 55.88 | 2x39P | 96.52 | 106.68 |
| 2x20P | 48.26 | 58.42 | 2x40P | 99.06 | 109.22 |
| 2x21P | 50.80 | 60.96 | | | |

Unit: mm

A2547WR-N-2xXP

2.54mm Pitch 90° Dual Row Box Header

Reference Informations:

- *Material: Pin: Brass/Gold over Nickel
Insulator: PBT, UL94V-0
- *Mates with CJT A2541H-N-2xXP, A2541H-N-2xXP-2, A2547HN-2xXP series Dual row Housing
- *Color: Black

Ordering Information:
A2547WR-N-2xXP - *** - ***
1 2 3

1. Part No.
2. Material:
(Blank): PBT, UL94V-0
6T: Nylon 6T, UL94V-0
6WT: PBT, UL94V-0, GWT 750 °C
3. Finish:
(Blank): Gold-flash
G15: 15µm (0.38µm) MIN. Select Gold (Mating Area)
100µm (2.54µm) MIN. Select Tin
G30: 30µm (0.76µm) MIN. Select Gold (Mating Area)
100µm (2.54µm) MIN. Select Tin
T: Tin over Nickel

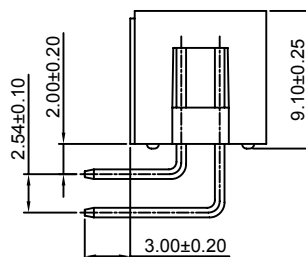
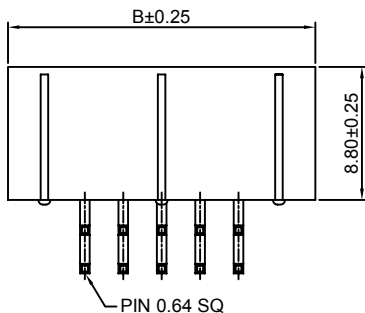
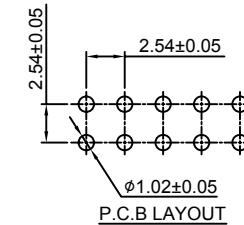
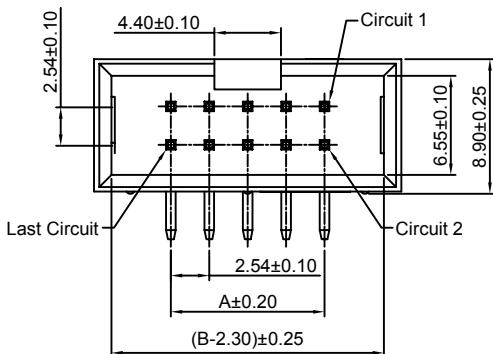
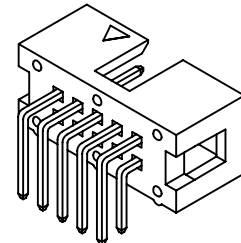

Ordering Information & Dimensions:

| PART NO. | Dimensions | | PART NO. | Dimensions | |
|----------|------------|-------|----------|------------|--------|
| | A | B | | A | B |
| 2x2P | 2.54 | 12.70 | 2x22P | 53.34 | 63.50 |
| 2x3P | 5.08 | 15.24 | 2x23P | 55.88 | 66.04 |
| 2x4P | 7.62 | 17.78 | 2x24P | 58.42 | 68.58 |
| 2x5P | 10.16 | 20.32 | 2x25P | 60.96 | 71.12 |
| 2x6P | 12.70 | 22.86 | 2x26P | 63.50 | 73.66 |
| 2x7P | 15.24 | 25.40 | 2x27P | 66.04 | 76.20 |
| 2x8P | 17.78 | 27.94 | 2x28P | 68.58 | 78.74 |
| 2x9P | 20.32 | 30.48 | 2x29P | 71.12 | 81.28 |
| 2x10P | 22.86 | 33.02 | 2x30P | 73.66 | 83.82 |
| 2x11P | 25.40 | 35.56 | 2x31P | 76.20 | 86.36 |
| 2x12P | 27.94 | 38.10 | 2x32P | 78.74 | 88.90 |
| 2x13P | 30.48 | 40.64 | 2x33P | 81.28 | 91.44 |
| 2x14P | 33.02 | 43.18 | 2x34P | 83.82 | 93.98 |
| 2x15P | 35.56 | 45.72 | 2x35P | 86.36 | 96.52 |
| 2x16P | 38.10 | 48.26 | 2x36P | 88.90 | 99.06 |
| 2x17P | 40.64 | 50.80 | 2x37P | 91.44 | 101.60 |
| 2x18P | 43.18 | 53.34 | 2x38P | 93.98 | 104.14 |
| 2x19P | 45.72 | 55.88 | 2x39P | 96.52 | 106.68 |
| 2x20P | 48.26 | 58.42 | 2x40P | 99.06 | 109.22 |
| 2x21P | 50.80 | 60.96 | | | |

Unit: mm

A2547WV-S-2xXP

2.54mm Pitch 180° Box Header - SMT TYPE

Reference Informations:

- *Material: Pin: Brass/Gold over Nickel
Insulator: Nylon 6T, UL94V-0
- *Mates with CJT A2547H, HA, HB, HC, HF, HG, HS-2xXP series Dual row Housing
- *Color: Black

Ordering Information:
A2547WV-S-2xXP - ^{***}/₁ - ^{***}/₂ - ^{***}/₃ - ^{***}/₄

1. Part No.
2. Material:
(Blank): Nylon 6T, UL94V-0
GWT: Nylon 6T, UL94V-0, GWT 750 °C
3. Finish:
(Blank): Gold-flash
G15: 15µm (0.38µm) MIN. Select Gold (Mating Area)
100µm (2.54µm) MIN. Select Tin
G30: 30µm (0.76µm) MIN. Select Gold (Mating Area)
100µm (2.54µm) MIN. Select Tin
T: Tin over Nickel
4. Size (L):
(blank): 14.35mm
L: 10.50mm

Ordering Information & Dimensions:

| PART NO. | Dimensions | | |
|----------|------------|--------|-------|
| | A | B | C |
| 2x3P | 5.08 | 26.92 | 13.14 |
| 2x4P | 7.62 | 29.46 | 15.68 |
| 2x5P | 10.16 | 32.00 | 18.22 |
| 2x6P | 12.70 | 34.54 | 20.76 |
| 2x7P | 15.24 | 37.08 | 23.30 |
| 2x8P | 17.78 | 39.62 | 25.84 |
| 2x9P | 20.32 | 42.16 | 28.38 |
| 2x10P | 22.86 | 44.70 | 30.92 |
| 2x11P | 25.40 | 47.24 | 33.46 |
| 2x12P | 27.94 | 49.78 | 36.00 |
| 2x13P | 30.48 | 52.32 | 38.54 |
| 2x14P | 33.02 | 54.86 | 41.08 |
| 2x15P | 35.56 | 57.40 | 43.62 |
| 2x16P | 38.10 | 59.94 | 46.16 |
| 2x17P | 40.64 | 62.48 | 48.70 |
| 2x18P | 43.18 | 65.02 | 51.24 |
| 2x19P | 45.72 | 67.56 | 53.78 |
| 2x20P | 48.26 | 70.10 | 56.32 |
| 2x21P | 50.80 | 72.64 | 58.86 |
| 2x22P | 53.34 | 75.18 | 61.40 |
| 2x23P | 55.88 | 77.72 | 63.94 |
| 2x24P | 58.42 | 80.26 | 66.48 |
| 2x25P | 60.96 | 82.80 | 69.02 |
| 2x26P | 63.50 | 85.34 | 71.56 |
| 2x27P | 66.04 | 87.88 | 74.10 |
| 2x28P | 68.58 | 90.42 | 76.64 |
| 2x29P | 71.12 | 92.96 | 79.18 |
| 2x30P | 73.66 | 95.50 | 81.72 |
| 2x31P | 76.20 | 98.04 | 84.26 |
| 2x32P | 78.74 | 100.58 | 86.80 |

Unit: mm

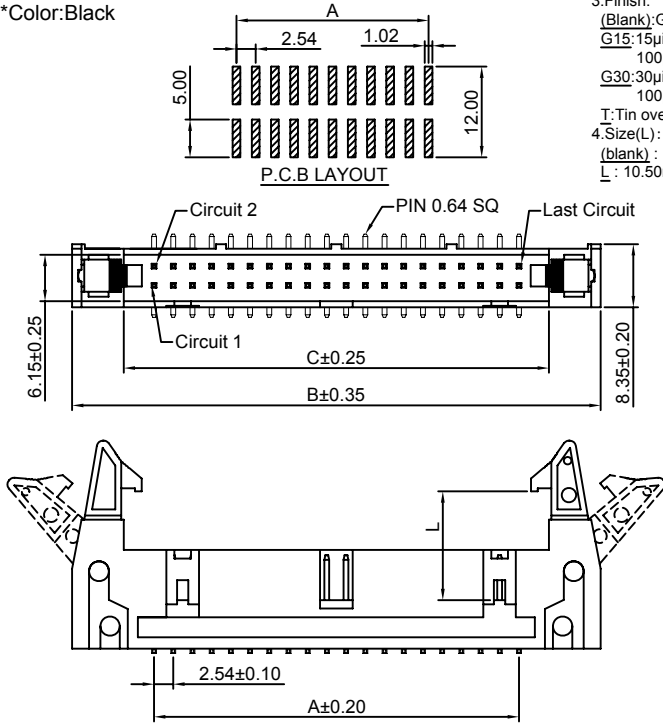

A2547WV-N-S-2xXP

2.54mm Pitch 180° Box Header - SMT TYPE

Reference Informations:

- *Material: Pin: Brass/Gold over Nickel
Insulator: Nylon 6T, UL94V-0
- *Mates with CJT A2541H-2xXP, A2541H-N-2xXP, A2547HN-2xXP series Dual row Housing
- *Color: Black

Ordering Information:
A2547WV-N-S-2xXP - ^{***}/₁ - ^{***}/₂ - ^{***}/₃

1. Part No.
2. Material:
(Blank): Nylon 6T, UL94V-0
GWT: Nylon 6T, UL94V-0, GWT 750 °C
3. Finish:
(Blank): Gold-flash
G15: 15µm (0.38µm) MIN. Select Gold (Mating Area)
100µm (2.54µm) MIN. Select Tin
G30: 30µm (0.76µm) MIN. Select Gold (Mating Area)
100µm (2.54µm) MIN. Select Tin
T: Tin over Nickel

Ordering Information & Dimensions:

| PART NO. | Dimensions | | PART NO. | Dimensions | |
|----------|------------|-------|----------|------------|--------|
| | A | B | | A | B |
| 2x2P | 2.54 | 12.70 | 2x22P | 53.34 | 63.50 |
| 2x3P | 5.08 | 15.24 | 2x23P | 55.88 | 66.04 |
| 2x4P | 7.62 | 17.78 | 2x24P | 58.42 | 68.58 |
| 2x5P | 10.16 | 20.32 | 2x25P | 60.96 | 71.12 |
| 2x6P | 12.70 | 22.86 | 2x26P | 63.50 | 73.66 |
| 2x7P | 15.24 | 25.40 | 2x27P | 66.04 | 76.20 |
| 2x8P | 17.78 | 27.94 | 2x28P | 68.58 | 78.74 |
| 2x9P | 20.32 | 30.48 | 2x29P | 71.12 | 81.28 |
| 2x10P | 22.86 | 33.02 | 2x30P | 73.66 | 83.82 |
| 2x11P | 25.40 | 35.56 | 2x31P | 76.20 | 86.36 |
| 2x12P | 27.94 | 38.10 | 2x32P | 78.74 | 88.90 |
| 2x13P | 30.48 | 40.64 | 2x33P | 81.28 | 91.44 |
| 2x14P | 33.02 | 43.18 | 2x34P | 83.82 | 93.98 |
| 2x15P | 35.56 | 45.72 | 2x35P | 86.36 | 96.52 |
| 2x16P | 38.10 | 48.26 | 2x36P | 88.90 | 99.06 |
| 2x17P | 40.64 | 50.80 | 2x37P | 91.44 | 101.60 |
| 2x18P | 43.18 | 53.34 | 2x38P | 93.98 | 104.14 |
| 2x19P | 45.72 | 55.88 | 2x39P | 96.52 | 106.68 |
| 2x20P | 48.26 | 58.42 | 2x40P | 99.06 | 109.22 |
| 2x21P | 50.80 | 60.96 | | | |

Unit: mm

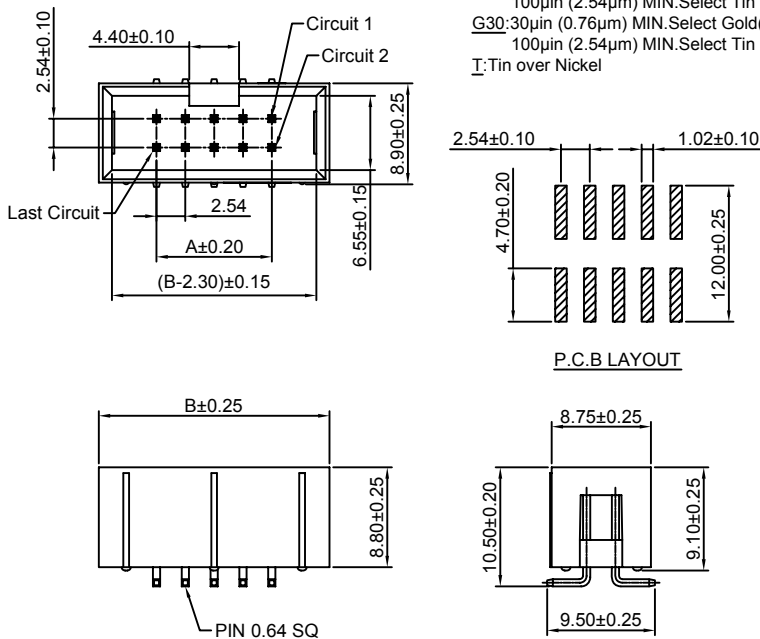

A2547WVA-N-2xXP

2.54mm Pitch 180° Box Header

Reference Informations:

- *Material: Pin: Brass/Gold over Nickel
Insulator: PBT, UL94V-0
- *Mates with CJT A2547 series Dual row Housing
- *Color: Black

Ordering Information:
A2547WVA-N-2xXP - ¹ - ² - ³ - ⁴ - ⁵

- Part No.
- Material:
(Blank): PBT, UL94V-0
6T: Nylon 6T, UL94V-0
GWT: PBT, UL94V-0, GWT 750°C
- Color:
(blank): Black
GY: Gray
BL: Blue
- Finish:
(Blank): Gold-flash
G15: 15µin (0.38µm) MIN. Select Gold (Mating Area)
100µin (2.54µm) MIN. Select Tin
G30: 30µin (0.76µm) MIN. Select Gold (Mating Area)
100µin (2.54µm) MIN. Select Tin
T: Tin over Nickel
- Size(D):
(blank): 2.90mm
D45: 4.50mm

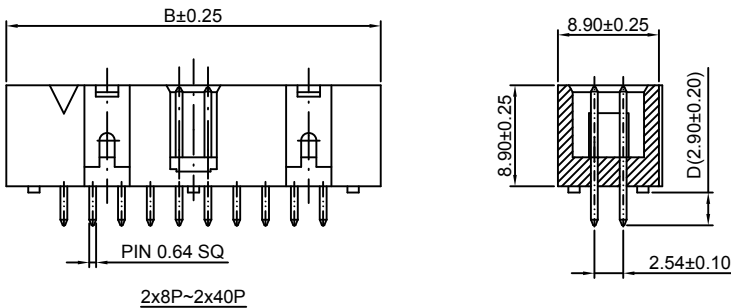
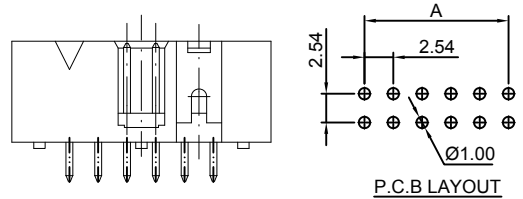

Ordering Information & Dimensions:

| PART NO. | Dimensions | | PART NO. | Dimensions | |
|----------|------------|-------|----------|------------|--------|
| | A | B | | A | B |
| 2x6P | 12.70 | 22.86 | 2x24P | 58.42 | 68.58 |
| 2x7P | 15.24 | 25.40 | 2x25P | 60.96 | 71.12 |
| 2x8P | 17.78 | 27.94 | 2x26P | 63.50 | 73.66 |
| 2x9P | 20.32 | 30.48 | 2x27P | 66.04 | 76.20 |
| 2x10P | 22.86 | 33.02 | 2x28P | 68.58 | 78.74 |
| 2x11P | 25.40 | 35.56 | 2x29P | 71.12 | 81.28 |
| 2x12P | 27.94 | 38.10 | 2x30P | 73.66 | 83.82 |
| 2x13P | 30.48 | 40.64 | 2x31P | 76.20 | 86.36 |
| 2x14P | 33.02 | 43.18 | 2x32P | 78.74 | 88.90 |
| 2x15P | 35.56 | 45.72 | 2x33P | 81.28 | 91.44 |
| 2x16P | 38.10 | 48.26 | 2x34P | 83.82 | 93.98 |
| 2x17P | 40.64 | 50.80 | 2x35P | 86.36 | 96.52 |
| 2x18P | 43.18 | 53.34 | 2x36P | 88.90 | 99.06 |
| 2x19P | 45.72 | 55.88 | 2x37P | 91.44 | 101.60 |
| 2x20P | 48.26 | 58.42 | 2x38P | 93.98 | 104.14 |
| 2x21P | 50.80 | 60.96 | 2x39P | 96.52 | 106.68 |
| 2x22P | 53.34 | 63.50 | 2x40P | 99.06 | 109.22 |
| 2x23P | 55.88 | 66.04 | | | |

Unit: mm

A2547WRA-N-2xXP

2.54mm Pitch 90° Box Header

Reference Informations:

- *Material: Pin: Brass/Gold over Nickel
Insulator: PBT, UL94V-0
- *Mates with CJT A2547 series Dual row Housing
- *Color: Black

Ordering Information:
A2547WRA-N-2xXP - ¹ - ² - ³ - ⁴ - ⁵

- Part No.
- Material:
(Blank): PBT, UL94V-0
6T: Nylon 6T, UL94V-0
GWT: PBT, UL94V-0, GWT 750°C
- Color:
(blank): Black
GY: Gray
BL: Blue
- Finish:
(Blank): Gold-flash
G15: 15µin (0.38µm) MIN. Select Gold (Mating Area)
100µin (2.54µm) MIN. Select Tin
G30: 30µin (0.76µm) MIN. Select Gold (Mating Area)
100µin (2.54µm) MIN. Select Tin
T: Tin over Nickel
- Size(D):
(blank): 4.50mm
D29: 2.90mm

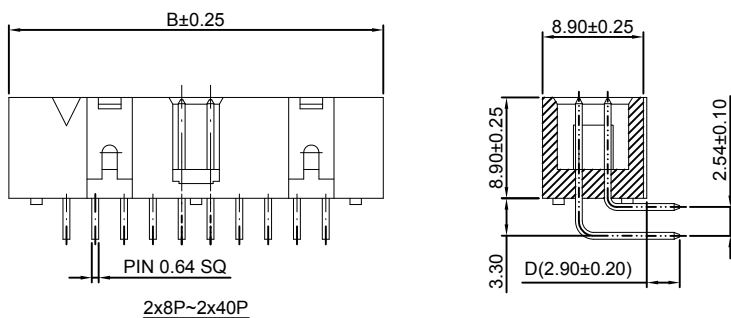
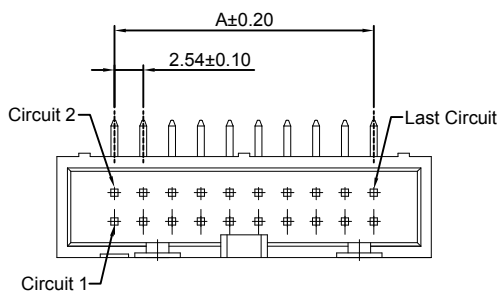
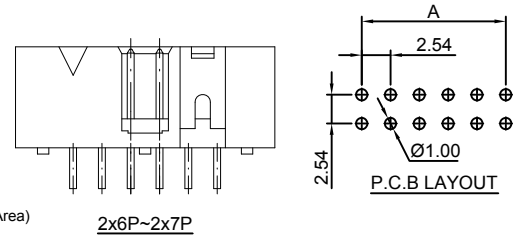

Ordering Information & Dimensions:

| PART NO. | Dimensions | | PART NO. | Dimensions | |
|----------|------------|-------|----------|------------|--------|
| | A | B | | A | B |
| 2x6P | 12.70 | 22.86 | 2x24P | 58.42 | 68.58 |
| 2x7P | 15.24 | 25.40 | 2x25P | 60.96 | 71.12 |
| 2x8P | 17.78 | 27.94 | 2x26P | 63.50 | 73.66 |
| 2x9P | 20.32 | 30.48 | 2x27P | 66.04 | 76.20 |
| 2x10P | 22.86 | 33.02 | 2x28P | 68.58 | 78.74 |
| 2x11P | 25.40 | 35.56 | 2x29P | 71.12 | 81.28 |
| 2x12P | 27.94 | 38.10 | 2x30P | 73.66 | 83.82 |
| 2x13P | 30.48 | 40.64 | 2x31P | 76.20 | 86.36 |
| 2x14P | 33.02 | 43.18 | 2x32P | 78.74 | 88.90 |
| 2x15P | 35.56 | 45.72 | 2x33P | 81.28 | 91.44 |
| 2x16P | 38.10 | 48.26 | 2x34P | 83.82 | 93.98 |
| 2x17P | 40.64 | 50.80 | 2x35P | 86.36 | 96.52 |
| 2x18P | 43.18 | 53.34 | 2x36P | 88.90 | 99.06 |
| 2x19P | 45.72 | 55.88 | 2x37P | 91.44 | 101.60 |
| 2x20P | 48.26 | 58.42 | 2x38P | 93.98 | 104.14 |
| 2x21P | 50.80 | 60.96 | 2x39P | 96.52 | 106.68 |
| 2x22P | 53.34 | 63.50 | 2x40P | 99.06 | 109.22 |
| 2x23P | 55.88 | 66.04 | | | |

Unit: mm

A2547FC-N-2xXP-Y

2.54mm Pitch IDC Socket

Reference Informations:

- *Material: Pin: Brass/Tin over Nickel
Insulator: PBT, UL94V-0
- *Mates with CJT A2547 series Dual row Wafer
- *Color: Black



Ordering Information:

A2547FC-N-2xXP-Y - *** - ** - ***
1 2 3 4

- Part No.
- Material:
(Blank): PBT, UL94V-0
6T: Nylon 6T, UL94V-0
GWT: PBT, UL94V-0, GWT 750°C
- Color:
(blank): Black
GY: Gray
- Finish:
(Blank): Tin over Nickel
G: Gold-flash
G15: 15µm (0.38µm) MIN. Select Gold (Mating Area)
100µm (2.54µm) MIN. Select Tin
G30: 30µm (0.76µm) MIN. Select Gold (Mating Area)
100µm (2.54µm) MIN. Select Tin

Ordering Information & Dimensions:

| PART NO. | Dimensions | | PART NO. | Dimensions | |
|----------|------------|-------|----------|------------|-------|
| | A | B | | A | B |
| 2x3P | 5.08 | 12.42 | 2x16P | 38.10 | 45.44 |
| 2x4P | 10.16 | 14.96 | 2x17P | 40.64 | 47.98 |
| 2x5P | 15.24 | 17.50 | 2x18P | 43.18 | 50.52 |
| 2x6P | 20.32 | 20.04 | 2x19P | 45.72 | 53.06 |
| 2x7P | 25.40 | 22.58 | 2x20P | 48.26 | 55.60 |
| 2x8P | 30.48 | 25.12 | 2x21P | 50.80 | 58.14 |
| 2x9P | 35.56 | 27.66 | 2x22P | 53.34 | 60.68 |
| 2x10P | 40.64 | 30.20 | 2x23P | 55.88 | 63.22 |
| 2x11P | 45.72 | 32.74 | 2x24P | 58.42 | 65.76 |
| 2x12P | 50.80 | 35.28 | 2x25P | 60.96 | 68.30 |
| 2x13P | 55.88 | 37.82 | 2x30P | 73.66 | 81.00 |
| 2x14P | 60.96 | 40.36 | 2x32P | 78.74 | 86.08 |
| 2x15P | 66.04 | 42.90 | | | |

Unit: mm

A2547FCWV-2xXP

2.54mm Pitch 180° IDC Wafer

Reference Informations:

- *Material: Pin: Brass/Tin over Nickel
Insulator: PBT, UL94V-0
- *Color: Black

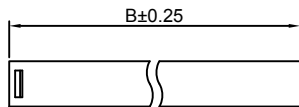

Ordering Information:

A2547FCWV-2xXP - *** - ** - ***
1 2 3 4

- Part No.
- Material:
(Blank): PBT, UL94V-0
6T: Nylon 6T, UL94V-0
GWT: PBT, UL94V-0, GWT 750°C
- Color:
(blank): Black
GY: Gray
- Finish:
(Blank): Tin over Nickel
G: Gold-flash
G15: 15µm (0.38µm) MIN. Select Gold (Mating Area)
100µm (2.54µm) MIN. Select Tin
G30: 30µm (0.76µm) MIN. Select Gold (Mating Area)
100µm (2.54µm) MIN. Select Tin

Ordering Information & Dimensions:

| PART NO. | Dimensions | | PART NO. | Dimensions | |
|----------|------------|-------|----------|------------|-------|
| | A | B | | A | B |
| 2x3P | 5.08 | 13.08 | 2x16P | 38.10 | 46.10 |
| 2x4P | 10.16 | 15.62 | 2x17P | 40.64 | 48.64 |
| 2x5P | 15.24 | 18.16 | 2x18P | 43.18 | 51.18 |
| 2x6P | 20.32 | 20.70 | 2x19P | 45.72 | 53.72 |
| 2x7P | 25.40 | 23.24 | 2x20P | 48.26 | 56.26 |
| 2x8P | 30.48 | 25.78 | 2x21P | 50.80 | 58.80 |
| 2x9P | 35.56 | 28.32 | 2x22P | 53.34 | 61.34 |
| 2x10P | 40.64 | 30.86 | 2x23P | 55.88 | 63.88 |
| 2x11P | 45.72 | 33.40 | 2x24P | 58.42 | 66.42 |
| 2x12P | 50.80 | 35.94 | 2x25P | 60.96 | 68.96 |
| 2x13P | 55.88 | 38.48 | 2x30P | 73.66 | 81.66 |
| 2x14P | 60.96 | 41.02 | 2x32P | 78.74 | 86.74 |
| 2x15P | 66.04 | 43.56 | | | |

Unit: mm

A2547HI-2xXP

2.54mm Pitch 180° Box Header

Reference Informations:

- *Material: Pin: Brass/Gold over Nickel
Insulator: PBT, UL94V-0
- *Mates with CJT A2547H-2xXP series Dual row Housing
- *Color: Gray

Ordering Information:

A2547HI-2xXP - *** - ***
1 2 3

- 1. Part No.
- 2. Material:
(Blank): PBT, UL94V-0
6T: Nylon 6T, UL94V-0
GWT: PBT, UL94V-0, GWT 750°C
- 3. Finish:
(Blank): Gold-flash
G15: 15µm (0.38µm) MIN. Select Gold (Mating Area)
100µm (2.54µm) MIN. Select Tin
G30: 30µm (0.76µm) MIN. Select Gold (Mating Area)
100µm (2.54µm) MIN. Select Tin
T: Tin over Nickel

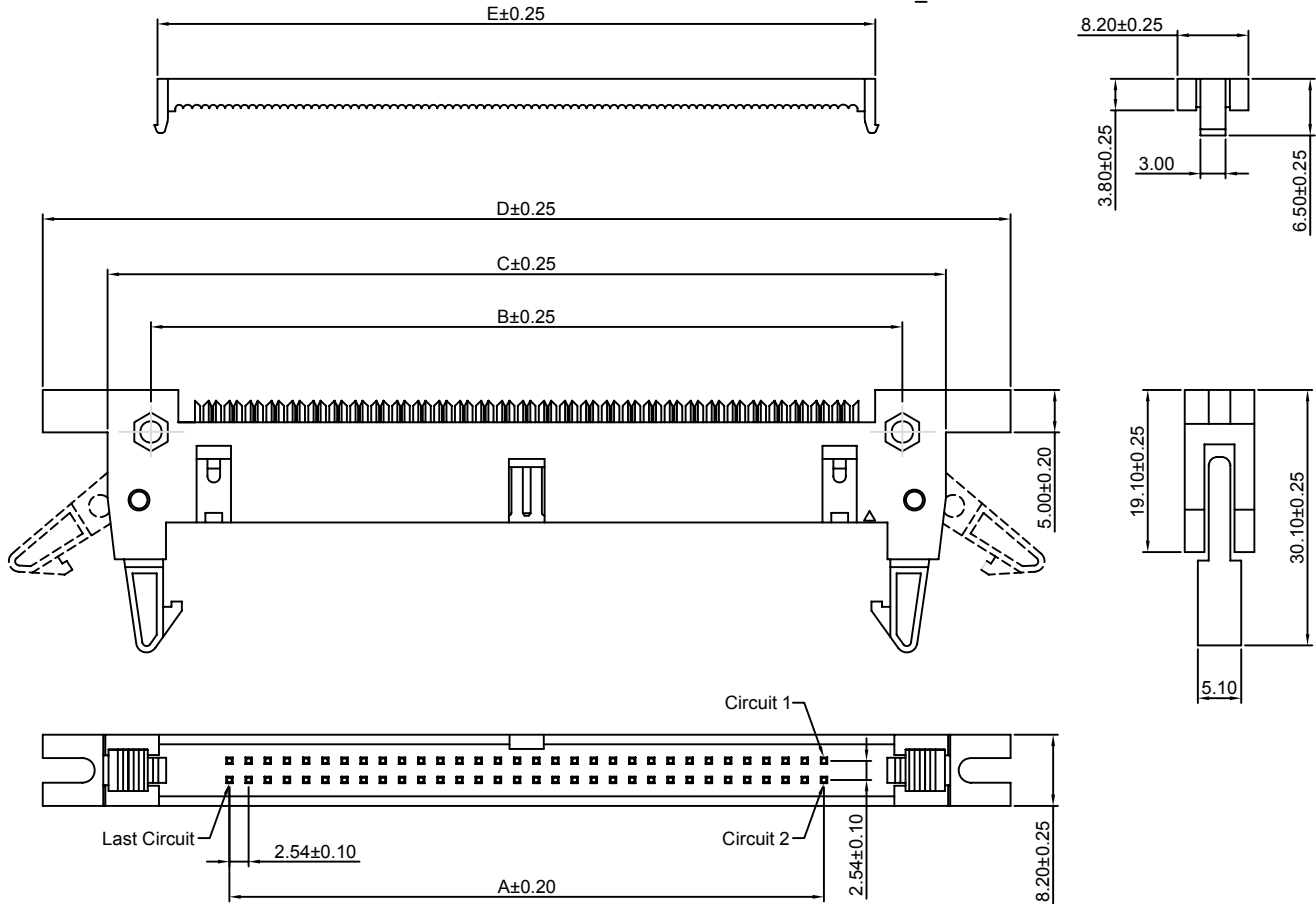

Ordering Information & Dimensions:

| PART NO. | Dimensions | | | | | PART NO. | Dimensions | | | | |
|----------|------------|-------|-------|-------|-------|----------|------------|-------|--------|--------|-------|
| | A | B | C | D | E | | A | B | C | D | E |
| 2x5P | 10.16 | 24.39 | 31.92 | 47.32 | 17.27 | 2x19P | 45.72 | 59.95 | 67.18 | 82.88 | 52.83 |
| 2x6P | 12.70 | 26.93 | 34.46 | 49.86 | 19.81 | 2x20P | 48.26 | 62.49 | 69.72 | 85.42 | 55.37 |
| 2x7P | 15.24 | 29.47 | 37.00 | 52.40 | 22.35 | 2x21P | 50.80 | 65.03 | 72.26 | 87.96 | 57.91 |
| 2x8P | 17.78 | 32.01 | 39.54 | 54.94 | 24.89 | 2x22P | 53.34 | 67.57 | 74.80 | 90.50 | 60.45 |
| 2x9P | 20.32 | 34.55 | 42.08 | 57.48 | 27.43 | 2x23P | 55.88 | 70.11 | 77.34 | 93.04 | 62.99 |
| 2x10P | 22.86 | 37.09 | 44.62 | 60.02 | 29.97 | 2x24P | 58.42 | 72.65 | 79.88 | 95.58 | 65.53 |
| 2x11P | 25.40 | 39.63 | 47.16 | 62.56 | 32.51 | 2x25P | 60.96 | 75.19 | 82.42 | 98.12 | 68.07 |
| 2x12P | 27.94 | 42.17 | 49.70 | 65.10 | 35.05 | 2x26P | 63.50 | 77.73 | 84.96 | 100.66 | 70.61 |
| 2x13P | 30.48 | 44.71 | 52.24 | 67.64 | 37.59 | 2x27P | 66.04 | 80.27 | 87.50 | 103.20 | 73.15 |
| 2x14P | 33.02 | 47.25 | 54.78 | 70.18 | 40.13 | 2x28P | 68.58 | 82.81 | 90.04 | 105.74 | 75.69 |
| 2x15P | 35.56 | 49.79 | 57.32 | 72.72 | 42.67 | 2x29P | 71.12 | 85.35 | 92.58 | 108.28 | 78.23 |
| 2x16P | 38.10 | 52.33 | 59.86 | 75.26 | 45.21 | 2x30P | 73.66 | 87.89 | 95.12 | 110.82 | 80.77 |
| 2x17P | 40.64 | 54.87 | 62.40 | 77.80 | 47.75 | 2x31P | 76.20 | 90.43 | 97.66 | 113.36 | 83.31 |
| 2x18P | 43.18 | 57.41 | 64.94 | 80.34 | 50.29 | 2x32P | 78.74 | 92.97 | 100.20 | 115.90 | 85.85 |

Unit: mm

A2547HIA-2xXP

2.54mm Pitch 180° Box Header

Reference Informations:

- *Material: Pin: Brass/Gold over Nickel
Insulator: PBT, UL94V-0
- *Mates with CJT A2547H-2xXP series Dual row Housing
- *Color: Gray

Ordering Information:

A2547HIA-2xXP - *** - ***
1 2 3

1. Part No.
2. Material:
(Blank): PBT, UL94V-0
6T: Nylon 6T, UL94V-0
GWT: PBT, UL94V-0, GWT 750°C
3. Finish:
(Blank): Gold-flash
G15: 15µm (0.38µm) MIN. Select Gold (Mating Area)
100µm (2.54µm) MIN. Select Tin
G30: 30µm (0.76µm) MIN. Select Gold (Mating Area)
100µm (2.54µm) MIN. Select Tin
T: Tin over Nickel

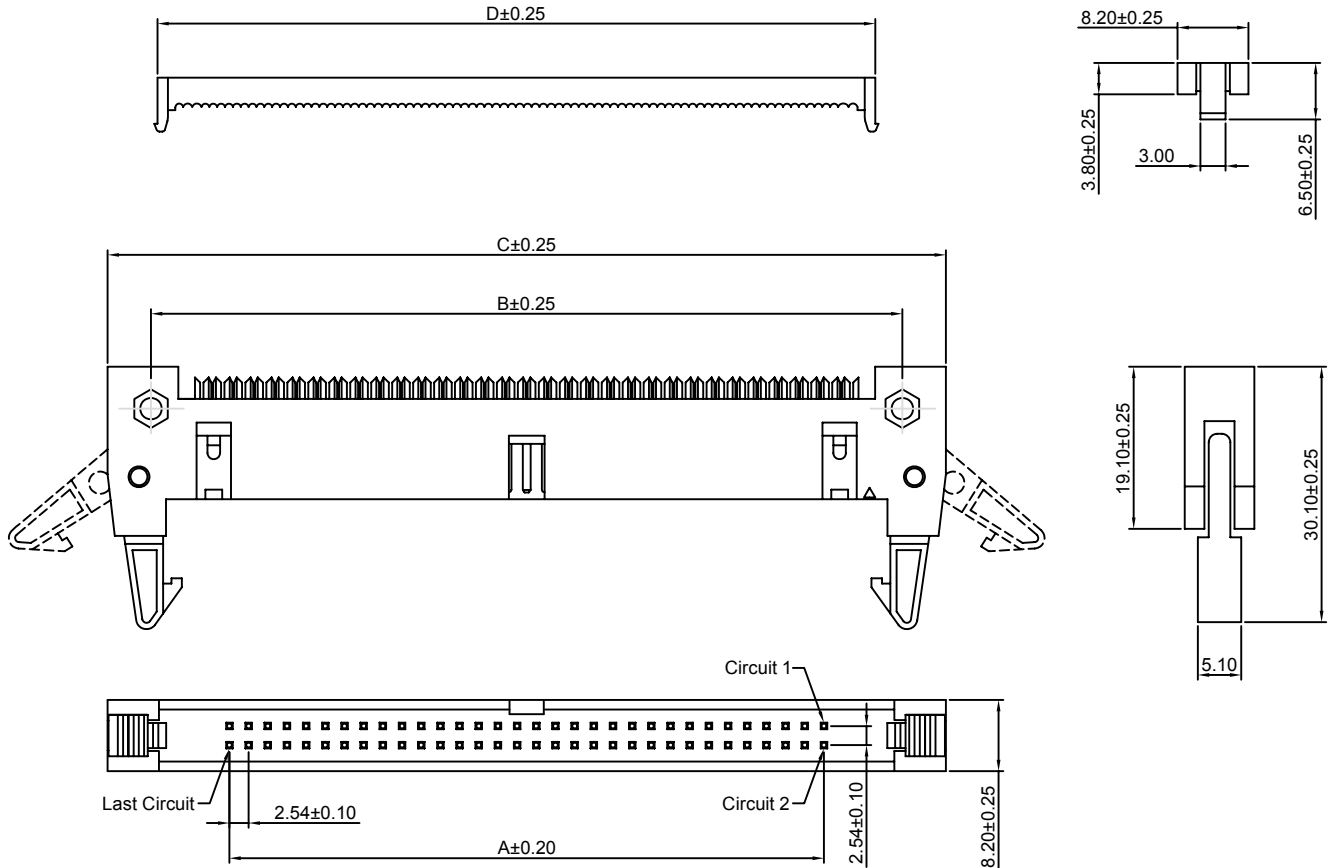

Ordering Information & Dimensions:

| PART NO. | Dimensions | | | | PART NO. | Dimensions | | | |
|----------|------------|-------|-------|-------|----------|------------|-------|--------|-------|
| | A | B | C | D | | A | B | C | D |
| 2x5P | 10.16 | 24.39 | 31.92 | 17.27 | 2x19P | 45.72 | 59.95 | 67.18 | 52.83 |
| 2x6P | 12.70 | 26.93 | 34.46 | 19.81 | 2x20P | 48.26 | 62.49 | 69.72 | 55.37 |
| 2x7P | 15.24 | 29.47 | 37.00 | 22.35 | 2x21P | 50.80 | 65.03 | 72.26 | 57.91 |
| 2x8P | 17.78 | 32.01 | 39.54 | 24.89 | 2x22P | 53.34 | 67.57 | 74.80 | 60.45 |
| 2x9P | 20.32 | 34.55 | 42.08 | 27.43 | 2x23P | 55.88 | 70.11 | 77.34 | 62.99 |
| 2x10P | 22.86 | 37.09 | 44.62 | 29.97 | 2x24P | 58.42 | 72.65 | 79.88 | 65.53 |
| 2x11P | 25.40 | 39.63 | 47.16 | 32.51 | 2x25P | 60.96 | 75.19 | 82.42 | 68.07 |
| 2x12P | 27.94 | 42.17 | 49.70 | 35.05 | 2x26P | 63.50 | 77.73 | 84.96 | 70.61 |
| 2x13P | 30.48 | 44.71 | 52.24 | 37.59 | 2x27P | 66.04 | 80.27 | 87.50 | 73.15 |
| 2x14P | 33.02 | 47.25 | 54.78 | 40.13 | 2x28P | 68.58 | 82.81 | 90.04 | 75.69 |
| 2x15P | 35.56 | 49.79 | 57.32 | 42.67 | 2x29P | 71.12 | 85.35 | 92.58 | 78.23 |
| 2x16P | 38.10 | 52.33 | 59.86 | 45.21 | 2x30P | 73.66 | 87.89 | 95.12 | 80.77 |
| 2x17P | 40.64 | 54.87 | 62.40 | 47.75 | 2x31P | 76.20 | 90.43 | 97.66 | 83.31 |
| 2x18P | 43.18 | 57.41 | 64.94 | 50.29 | 2x32P | 78.74 | 92.97 | 100.20 | 85.85 |

Unit: mm

X-ON Electronics

Largest Supplier of Electrical and Electronic Components

Click to view similar products for [Headers & Wire Housings](#) category:

Click to view products by [Changjiang](#) manufacturer:

Other Similar products are found below :

[95000-104TRLF](#) [10135584-644402LF](#) [DF62W-EP2022PCA](#) [95000-106TRLF](#) [DF62W-2022SCA](#) [DF62W-EP2022PC](#) [2203348](#) [DF62W-2022SC](#) [1084018](#) [1029039](#) [1084017](#) [802-10-012-10-002000](#) [1112640](#) [1112639](#) [891-007-9SS-BST1T](#) [000-34000](#) [0008550134](#) [0009482033](#) [0009507031](#) [57102-F02-18ULF](#) [57102-S06-03LF](#) [57202-S52-04LF](#) [PCN6-15S-2.5E](#) [0039019024](#) [58102-G61-06LF](#) [582553-1](#) [0009485154](#) [0009508121](#) [009176003701906](#) [0022285053](#) [0050291907](#) [018731A](#) [LY20-4P-DT1-P1E-BR](#) [02.125.8002.8](#) [60101931](#) [60598-1 \(Cut Strip\)](#) [M1625-3R/100](#) [61062-3](#) [61082-181009](#) [CSU011177004](#) [636-1427](#) [638009-1](#) [641938-9](#) [641991-4](#) [644168-1](#) [644827-2](#) [647662-1](#) [65039-019ELF](#) [65692-001LF](#) [65781-018](#)