

## Specifications

- Current rating: 3A AC, DC
- Voltage rating: 300V AC, DC
- Temperature range: -40°C ~ +105°C
- Contact resistance: 5mΩ Max.
- Insulation resistance: 1000MΩ Min.
- Withstanding voltage: 1100V AC/minute
- \*Compliant with RoHS and REACH\*
- \*Meet the HF/Halogen Free, need to customize\*
- \*Contact CJT for details\*

## Standards



## Contact Layout

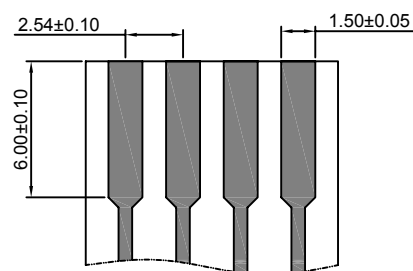

### A2550-T

2.54mm Pitch High Insertion Force Crimp Terminal

**Reference Informations:**

\*Used in CJT A2550 series Housing

Use With CJT A2550 series Housing:

Single Row	A2550H-XP,A2550HA-XP,A2550HB-XP,A2550H-XP-A
	A2550H-XP-B,A2550H-XP-C,A2550H-XP-C1,A2550H-XP-D
	A2550H-XP-E,A2550H-XP-F,A2550H-XP-J
Dual Row	A2550H-2xXP,A2550HA-2xXP

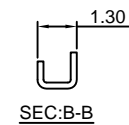
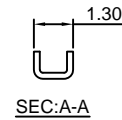
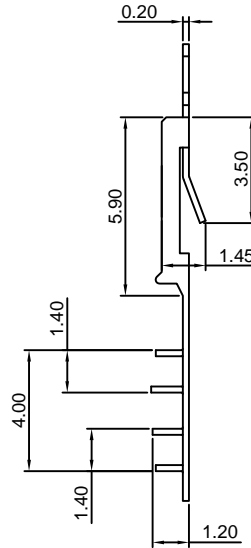
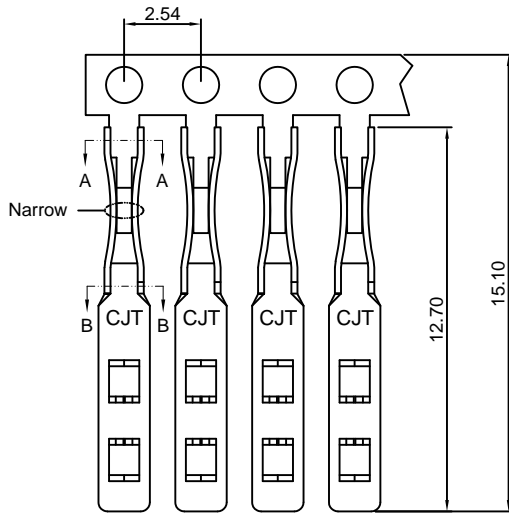

**Ordering information & Specifications:**

Unit:mm

Part NO.	Wire Range	Insulation O.D.	Material	Finish	Qty/reel
A2550-TP	FFC WIRE	-----	Phosphor Bronze	Tin over Nickel	20,000 PCS
A2550-GP	FFC WIRE	-----	Phosphor Bronze	Gold over Nickel	20,000 PCS

Optional Gold plating available but MOQ requested

### A2550-T-H

2.54mm Pitch Low insertion Force Crimp Terminal

**Reference Informations:**

\*Used in CJT A2550 series Housing

Use With CJT A2550 series Housing:

Single Row	A2550H-XP,A2550HA-XP,A2550HB-XP,A2550H-XP-A
	A2550H-XP-B,A2550H-XP-C,A2550H-XP-C1,A2550H-XP-D
	A2550H-XP-E,A2550H-XP-F,A2550H-XP-J
Dual Row	A2550H-2xXP,A2550HA-2xXP

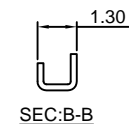
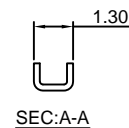
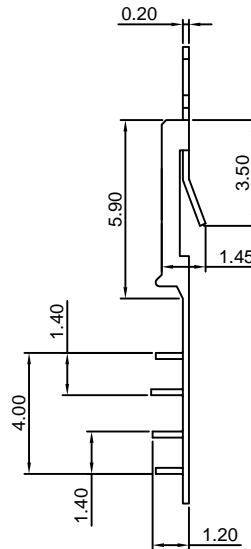
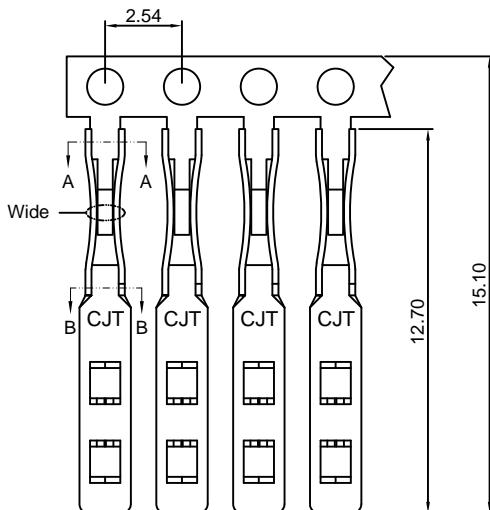

**Ordering information & Specifications:**

Unit:mm

Part NO.	Wire Range	Insulation O.D.	Material	Finish	Qty/reel
A2550-TP-H	FFC WIRE	-----	Phosphor Bronze	Tin over Nickel	20,000 PCS
A2550-GP-H	FFC WIRE	-----	Phosphor Bronze	Gold over Nickel	20,000 PCS

Optional Gold plating available but MOQ requested

### A2550-T-CR

2.54mm Pitch High Insertion Force Crimp Terminal

**Reference Informations:**

\*Used in CJT A2550 series Housing

Use With CJT A2550 series Housing:

Single Row	A2550H-XP,A2550HA-XP,A2550HB-XP,A2550H-XP-A
	A2550H-XP-B,A2550H-XP-C,A2550H-XP-C1,A2550H-XP-D
	A2550H-XP-E,A2550H-XP-F,A2550H-XP-J
Dual Row	A2550H-2xXP,A2550HA-2xXP

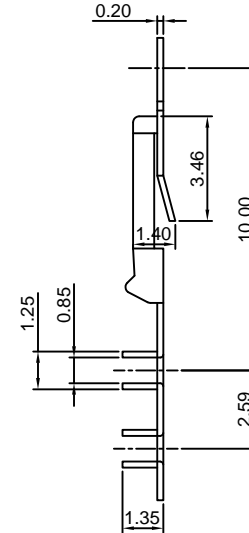
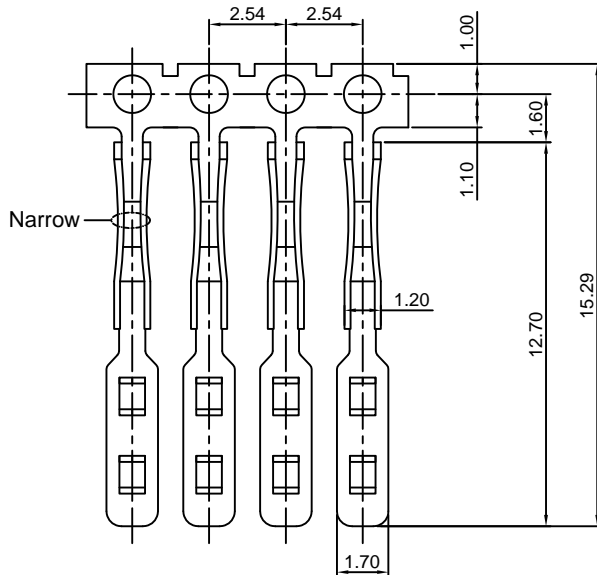

Ordering information & Specifications:

Unit:mm

Part NO.	Wire Range	Insulation O.D.	Material	Finish	Qty/reel
A2550-TP-CR	FFC WIRE	-----	Phosphor Bronze	Tin over Nickel	20,000 PCS
A2550-GP-CR	FFC WIRE	-----	Phosphor Bronze	Gold over Nickel	20,000 PCS

Optional Gold plating available but MOQ requested

### A2550-T-H-CR

2.54mm Pitch Low insertion Force Crimp Terminal

**Reference Informations:**

\*Used in CJT A2550 series Housing

Use With CJT A2550 series Housing:

Single Row	A2550H-XP,A2550HA-XP,A2550HB-XP,A2550H-XP-A
	A2550H-XP-B,A2550H-XP-C,A2550H-XP-C1,A2550H-XP-D
	A2550H-XP-E,A2550H-XP-F,A2550H-XP-J
Dual Row	A2550H-2xXP,A2550HA-2xXP

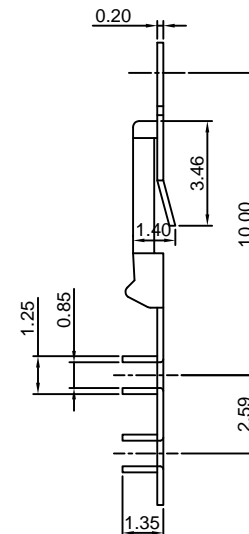
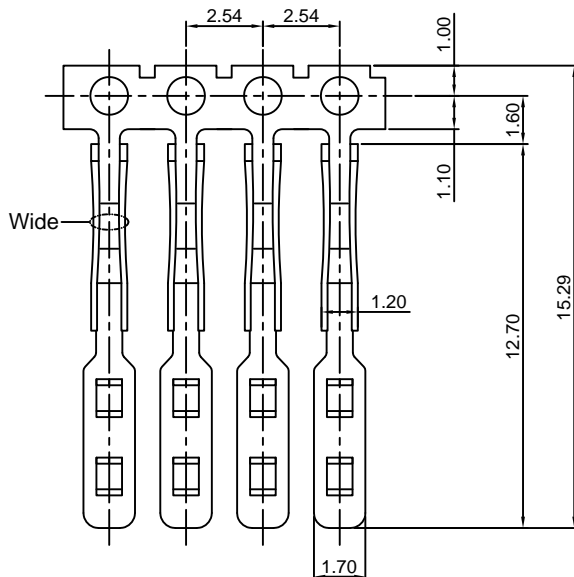

Ordering information & Specifications:

Unit:mm

Part NO.	Wire Range	Insulation O.D.	Material	Finish	Qty/reel
A2550-TP-H-CR	FFC WIRE	-----	Phosphor Bronze	Tin over Nickel	20,000 PCS
A2550-GP-H-CR	FFC WIRE	-----	Phosphor Bronze	Gold over Nickel	20,000 PCS

Optional Gold plating available but MOQ requested

### A2550-T-A

2.54mm pitch Crimp Flex Terminal

**Reference Informations:**

\*Used in CJT A2550 series Housing

Use With CJT A2550 series Housing:

Single Row	A2550H-XP, A2550HA-XP, A2550HB-XP, A2550H-XP-A
	A2550H-XP-B, A2550H-XP-C, A2550H-XP-C1, A2550H-XP-D
	A2550H-XP-E, A2550H-XP-F, A2550H-XP-J
Dual Row	A2550H-2xXP, A2550HA-2xXP

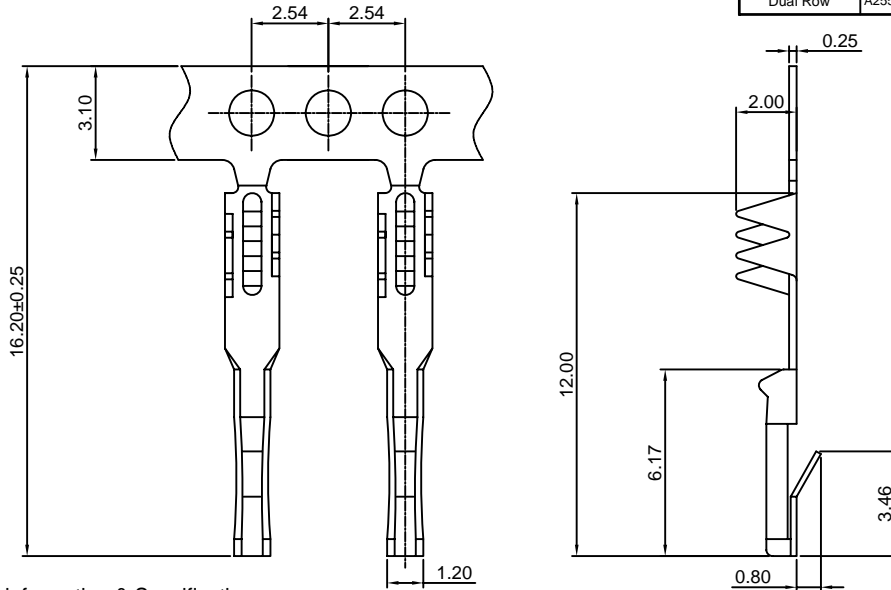

Ordering information & Specifications:

Unit:mm

Part NO.	Wire Range	Insulation O.D.	Material	Finish	Qty/reel
A2550-TP-A	FFC WIRE	-----	Phosphor Bronze	Tin over Nickel	10,000 PCS
A2550-GP-A	FFC WIRE	-----	Phosphor Bronze	Gold over Nickel	10,000 PCS

Optional Gold plating available but MOQ requested

### A2550-T-C

2.54mm Pitch Hi-Flex Crimp Terminal

**Reference Informations:**

\*Used in CJT A2550 series Housing

\*The Hi-Flex female contact designed to offer a stable insertion force and low contact resistance over larger number of mating cycles

\*More resistant to damage by bent or angled pins, primarily on test devices

Use With CJT A2550 series Housing:

Single Row	A2550H-XP, A2550HA-XP, A2550HB-XP, A2550H-XP-A
	A2550H-XP-B, A2550H-XP-C, A2550H-XP-C1, A2550H-XP-D
	A2550H-XP-E, A2550H-XP-F, A2550H-XP-J
Dual Row	A2550H-2xXP, A2550HA-2xXP

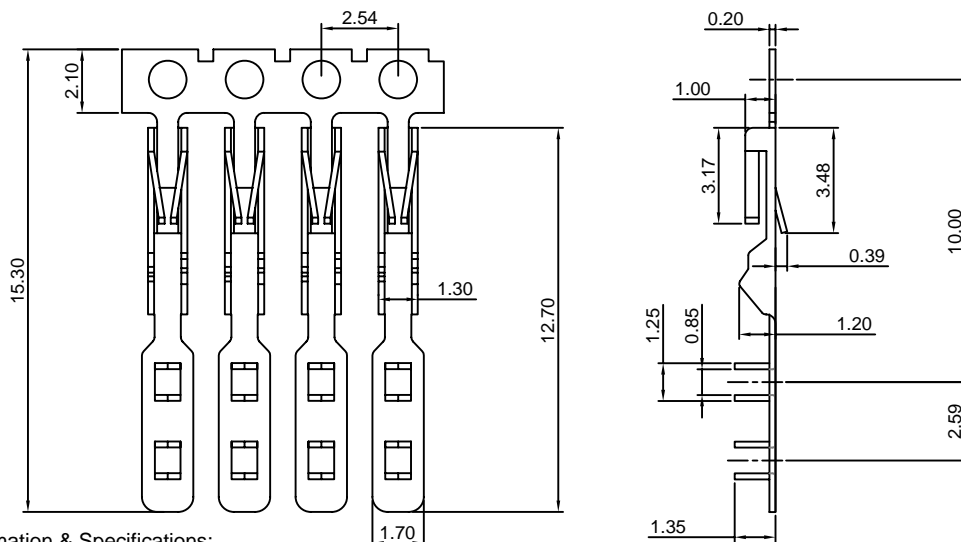

Ordering information & Specifications:

Unit:mm

Part NO.	Wire Range	Insulation O.D.	Material	Finish	Qty/reel
A2550-TP-C	FFC WIRE	-----	Phosphor Bronze	Tin over Nickel	20,000 PCS
A2550-GP-C	FFC WIRE	-----	Phosphor Bronze	Gold over Nickel	20,000 PCS

Optional Gold plating available but MOQ requested

### A2550-T-D

2.54mm pitch Crimp Flex Terminal

**Reference Informations:**

\*Designed for Soldering directly to Flexible PCB or Ultra Thin Rigged PCBs

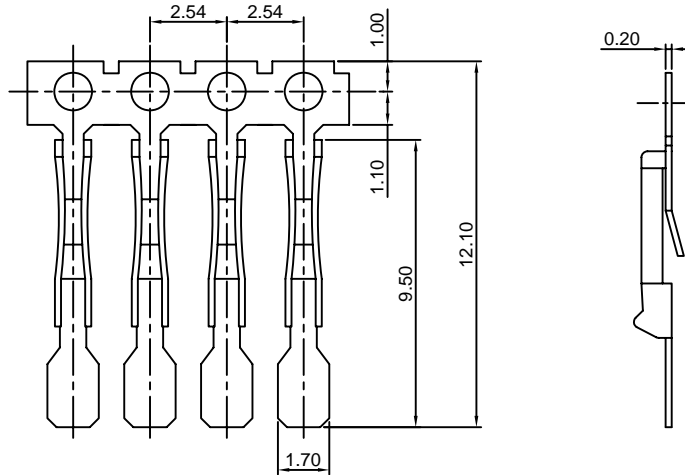

Ordering information & Specifications:

Unit:mm

Part NO.	Wire Range	Insulation O.D.	Material	Finish	Qty/reel
A2550-TP-D	PCBs	-----	Phosphor Bronze	Tin over Nickel	20,000 PCS
A2550-GP-D	PCBs	-----	Phosphor Bronze	Gold over Nickel	20,000 PCS

Optional Gold plating available but MOQ requested

### A2550-T-E

2.54mm pitch Crimp Flex Terminal

**Reference Informations:**

\*Used in CJT A2550 series Housing

Use With CJT A2550 series Housing :

Single Row	A2550H-XP-M A2550H-XP-M1 A2550H-XP-M2 A2550H-XP-MH
	A2550H-XP-M3

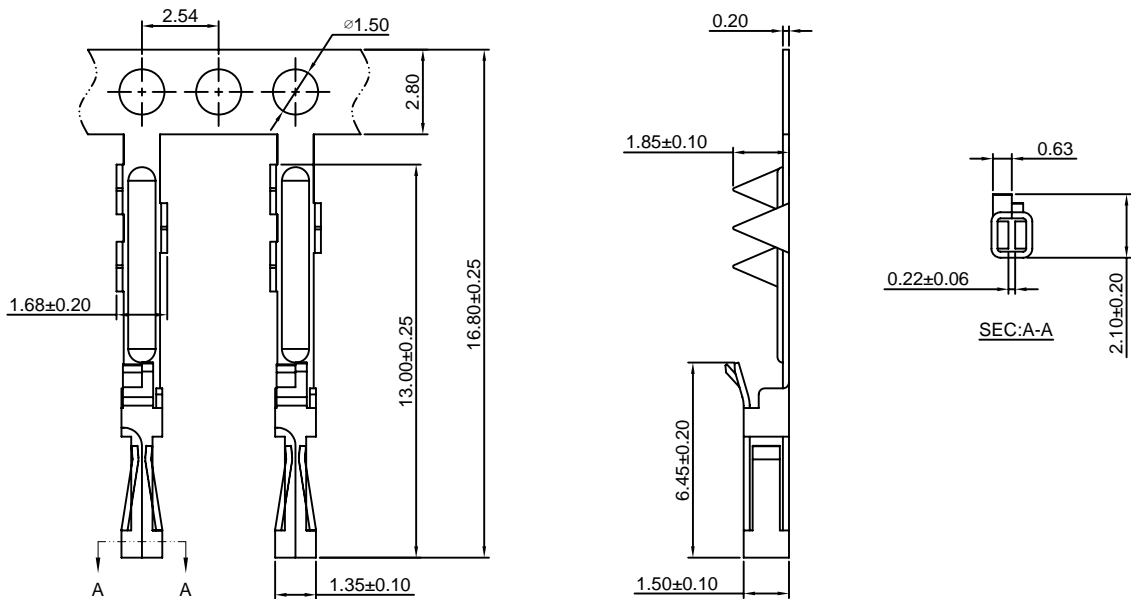

Ordering information & Specifications:

Unit:mm

Part NO.	Wire Range	Insulation O.D.	Material	Finish	Qty/reel
A2550-TP-E	FFC WIRE	-----	Phosphor Bronze	Tin over Nickel	15,000 PCS
A2550-GP-E	FFC WIRE	-----	Phosphor Bronze	Gold over Nickel	15,000 PCS

Optional Gold plating available but MOQ requested

### A2550-T-F

2.54mm pitch Crimp Flex Terminal

**Reference Informations:**

\*Used in FFC Wire and Electronic wire

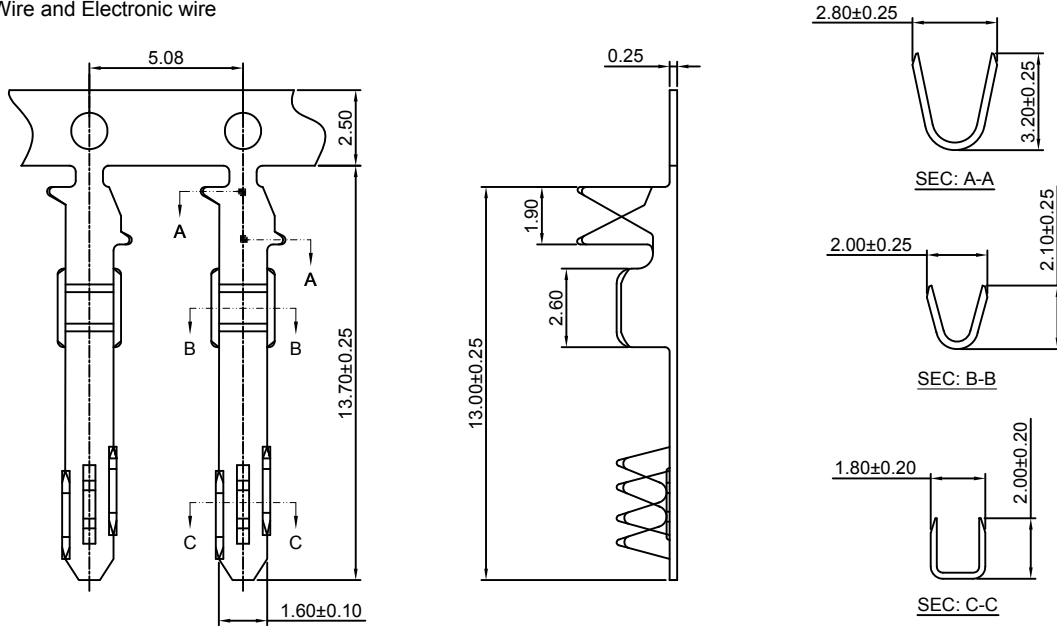

**Ordering information & Specifications:**

Unit:mm

Part NO.	Wire Range	Insulation O.D.	Material	Finish	Qty/reel
A2550-TP-F	FFC WIRE/AWG#20-#26	1.80mm(max)	Phosphor Bronze	Tin over Nickel	15,000 PCS
A2550-GP-F	FFC WIRE/AWG#20-#26	1.80mm(max)	Phosphor Bronze	Gold over Nickel	15,000 PCS

Optional Gold plating available but MOQ requested

### A2550-T-J

2.54mm pitch Crimp Flex Terminal

**Reference Informations:**

\*Used in CJT A2550 series Housing

Use With CJT A2550 series Housing :

Single Row	A2550H-XP-G, A2550H-XP-H, A2550H-XP-I
------------	---------------------------------------

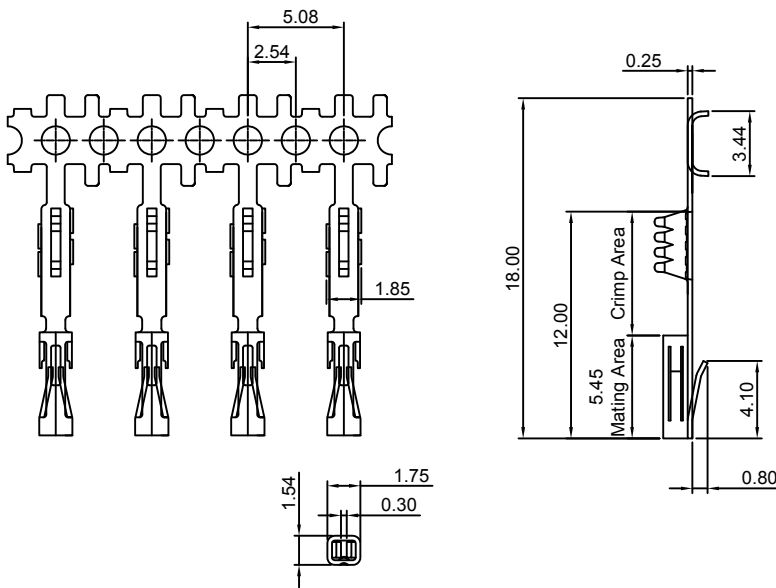

**Ordering Information:**

A2550-GP-J - \*\*\*  
1 2

1.Part No.

2.Finish

- TG :Mating Area : 100µin (2.54µm) MIN. Tin  
Crimp Area : 1µin (0.025µm) MIN. Gold
- GT15 :Mating Area : 15µin (0.38µm) MIN. Gold  
Crimp Area : 100µin (2.54µm) MIN. Tin
- GT30 :Mating Area : 30µin (0.76µm) MIN. Gold  
Crimp Area : 100µin (2.54µm) MIN. Tin
- GT50 :Mating Area : 50µin (1.27µm) MIN. Gold  
Crimp Area : 100µin (2.54µm) MIN. Tin
- GG15 :Mating Area : 15µin (0.38µm) MIN. Gold  
Crimp Area : 1µin (0.025µm) MIN. Gold
- GG30 :Mating Area : 30µin (0.76µm) MIN. Gold  
Crimp Area : 1µin (0.025µm) MIN. Gold
- GG50 :Mating Area : 50µin (1.27µm) MIN. Gold  
Crimp Area : 1µin (0.025µm) MIN. Gold

**Ordering information & Specifications:**

Unit:mm

Part NO.	Wire Range	Insulation O.D.	Material	Finish	Qty/reel
A2550-TP-J	FFC WIRE	-----	Phosphor Bronze	Tin over Nickel	10,000 PCS
A2550-GP-J	FFC WIRE	-----	Phosphor Bronze	Gold over Nickel	10,000 PCS

Optional Gold plating available but MOQ requested

### A2550-T-K

2.54mm pitch Crimp Flex Terminal

**Reference Informations:**

\*Used in CJT A2550HK series Housing

Use With CJT A2550 series Housing:

Single Row	A2550HK-XP
Dual Row	A2550HK-2xXP

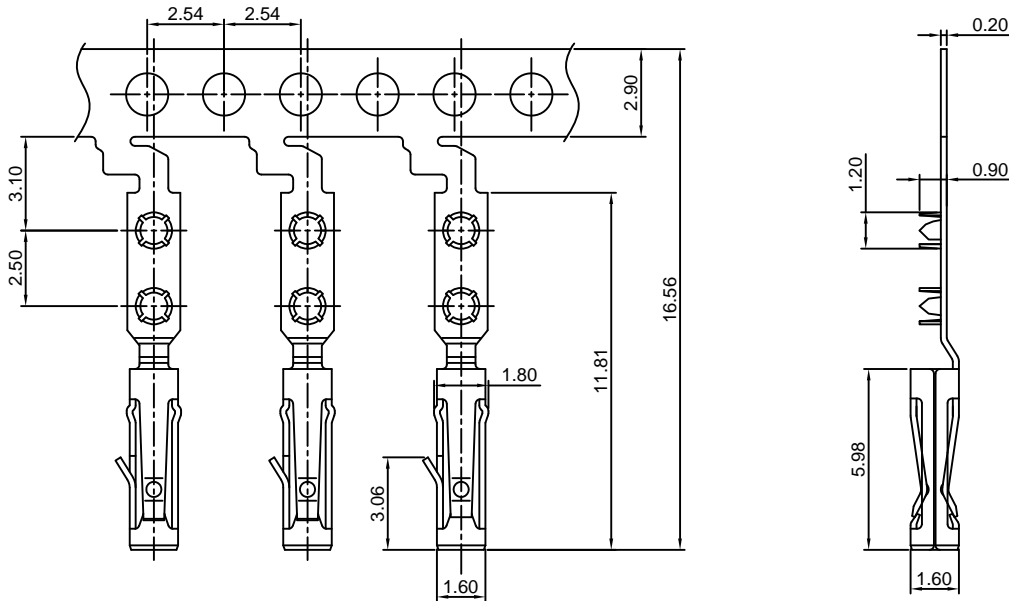

Ordering information & Specifications:

Unit:mm

Part NO.	Wire Range	Insulation O.D.	Material	Finish	Qty/reel
A2550-TP-K	FFC WIRE	-----	Phosphor Bronze	Tin over Nickel	20,000 PCS
A2550-GP-K	FFC WIRE	-----	Phosphor Bronze	Gold over Nickel	20,000 PCS

Optional Gold plating available but MOQ requested

### A2550M-T

2.54mm pitch Crimp Flex Terminal

**Reference Informations:**

\*Used in CJT A2550 series Housing

Use With CJT A2550 series Housing:

Single Row	A2550H-XP, A2550H-XP-D
Dual Row	A2550H-2xXP

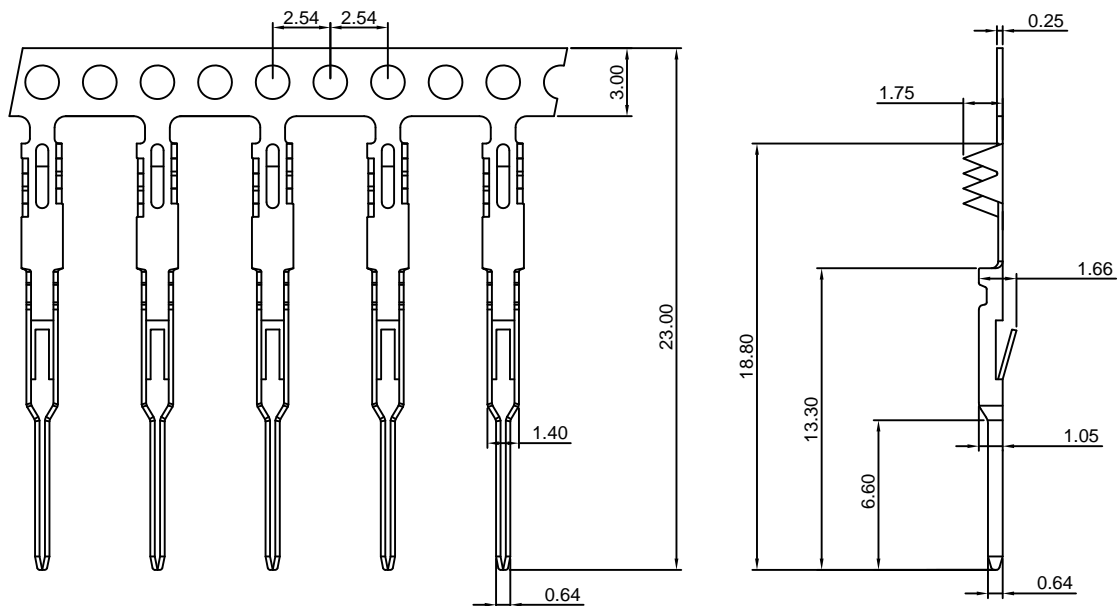

Ordering information & Specifications:

Unit:mm

Part NO.	Wire Range	Insulation O.D.	Material	Finish	Qty/reel
A2550M-TP	FFC WIRE	-----	Phosphor Bronze	Tin over Nickel	10,000 PCS
A2550M-GP	FFC WIRE	-----	Phosphor Bronze	Gold over Nickel	10,000 PCS

Optional Gold plating available but MOQ requested

### A2550M-T-C

2.54mm pitch Crimp Flex Terminal

**Reference Informations:**

\*Used in FFC Wire

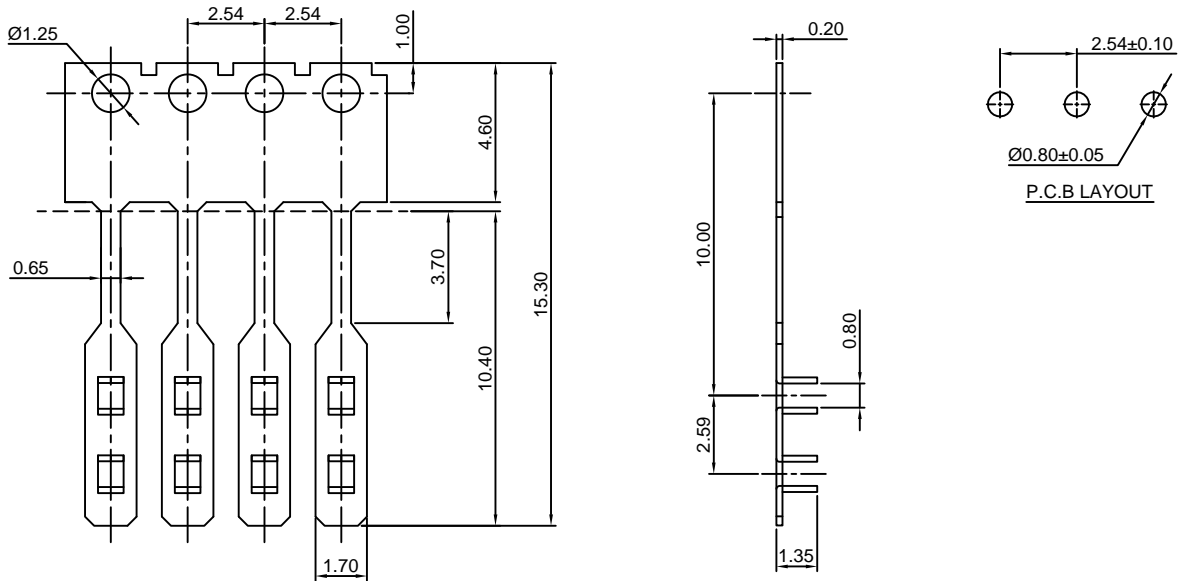

**Ordering information & Specifications:**

Unit:mm

Part NO.	Wire Range	Insulation O.D.	Material	Finish	Qty/reel
A2550M-TP-C	FFC WIRE	-----	Phosphor Bronze	Tin over Nickel	20,000 PCS
A2550M-GP-C	FFC WIRE	-----	Phosphor Bronze	Gold over Nickel	20,000 PCS

Optional Gold plating available but MOQ requested

### A2550M-T-CA

2.54mm pitch Crimp Flex Terminal

**Reference Informations:**

\*Used in FFC Wire

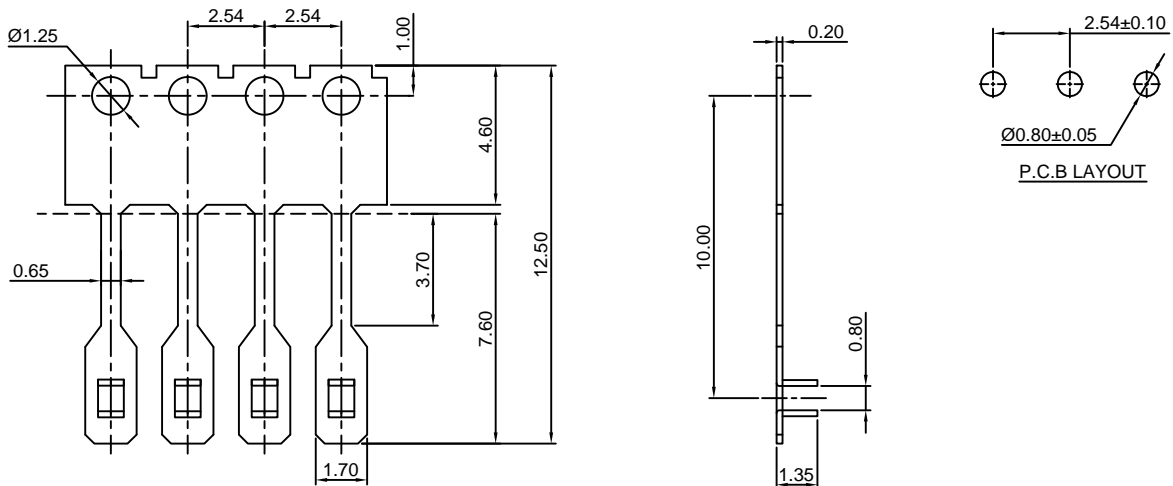

**Ordering information & Specifications:**

Unit:mm

Part NO.	Wire Range	Insulation O.D.	Material	Finish	Qty/reel
A2550M-TP-CA	FFC WIRE	-----	Phosphor Bronze	Tin over Nickel	20,000 PCS
A2550M-GP-CA	FFC WIRE	-----	Phosphor Bronze	Gold over Nickel	20,000 PCS

Optional Gold plating available but MOQ requested



### A2550M-T-C1

2.54mm pitch Crimp Flex Terminal

**Reference Informations:**

\*Used in FFC Wire

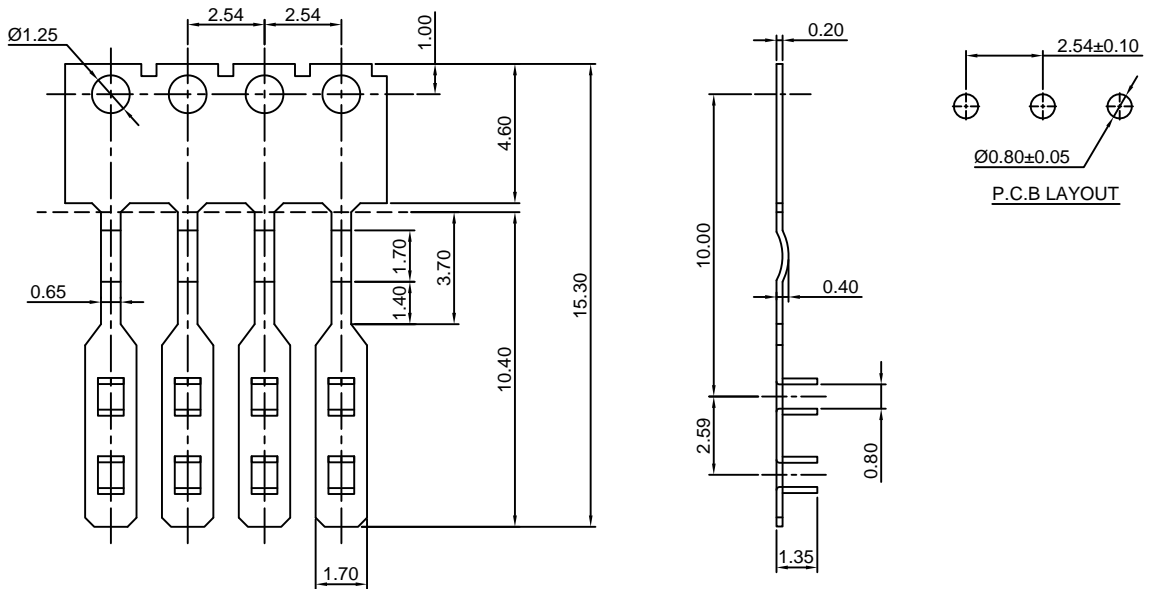

**Ordering information & Specifications:**

Unit:mm

Part NO.	Wire Range	Insulation O.D.	Material	Finish	Qty/reel
A2550M-TP-C1	FFC WIRE	-----	Phosphor Bronze	Tin over Nickel	20,000 PCS
A2550M-GP-C1	FFC WIRE	-----	Phosphor Bronze	Gold over Nickel	20,000 PCS

Optional Gold plating available but MOQ requested

### A2550M-T-C1A

2.54mm pitch Crimp Flex Terminal

**Reference Informations:**

\*Used in FFC Wire

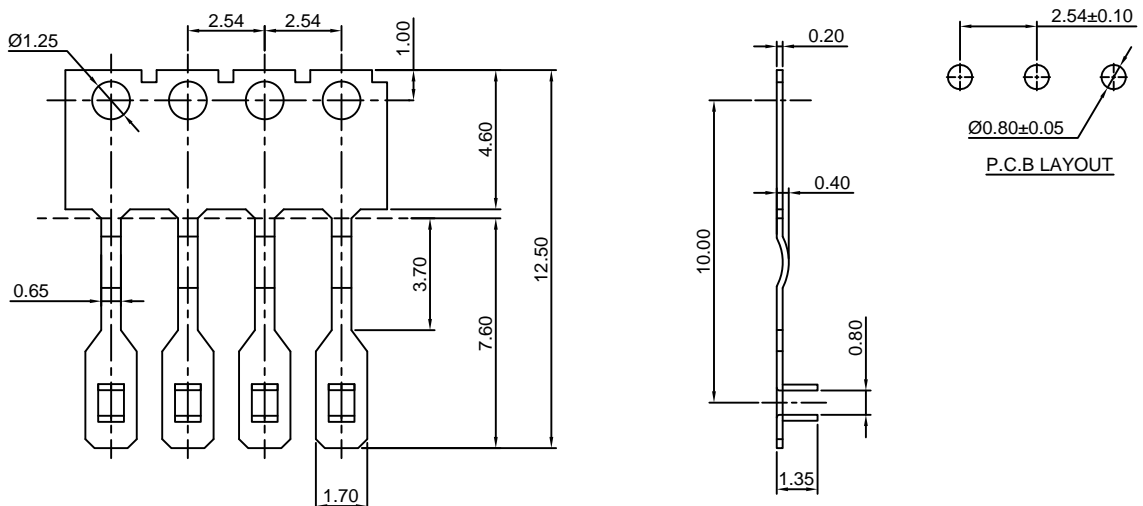

**Ordering information & Specifications:**

Unit:mm

Part NO.	Wire Range	Insulation O.D.	Material	Finish	Qty/reel
A2550M-TP-C1A	FFC WIRE	-----	Phosphor Bronze	Tin over Nickel	20,000 PCS
A2550M-GP-C1A	FFC WIRE	-----	Phosphor Bronze	Gold over Nickel	20,000 PCS

Optional Gold plating available but MOQ requested

### A2550M-T-C2

2.54mm pitch Crimp Flex Terminal

**Reference Informations:**

\*Used in FFC Wire

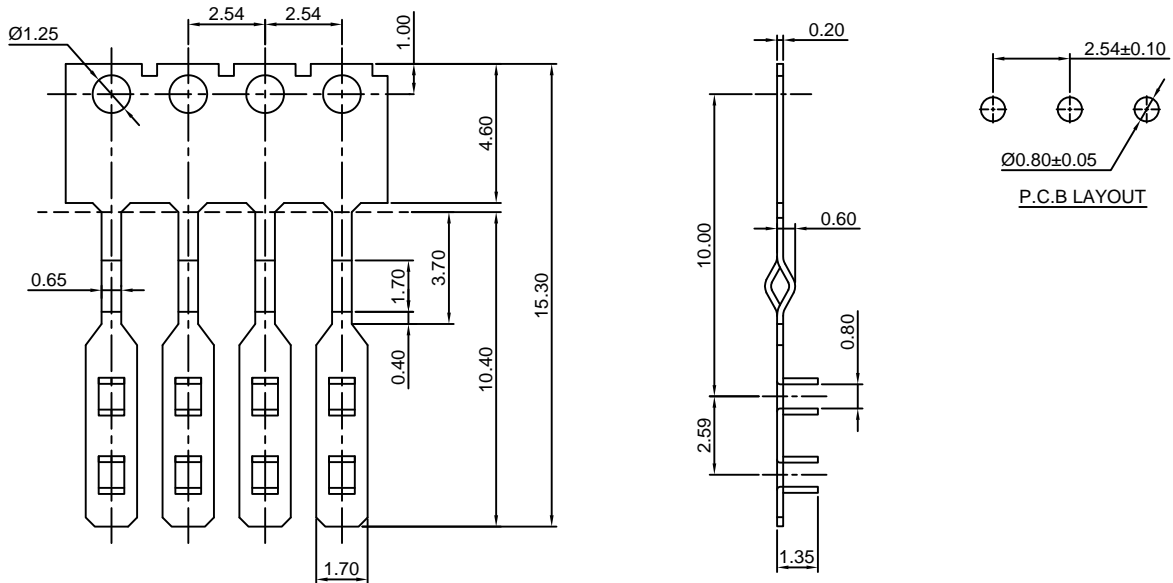

**Ordering information & Specifications:**

Unit:mm

Part NO.	Wire Range	Insulation O.D.	Material	Finish	Qty/reel
A2550M-TP-C2	FFC WIRE	-----	Phosphor Bronze	Tin over Nickel	20,000 PCS
A2550M-GP-C2	FFC WIRE	-----	Phosphor Bronze	Gold over Nickel	20,000 PCS

Optional Gold plating available but MOQ requested

### A2550M-T-D

2.54mm pitch Crimp Flex Terminal

**Reference Informations:**

\*Used in CJT A2550HM A2550HMA

A2550H-M1 A2550H-M3 series Housing

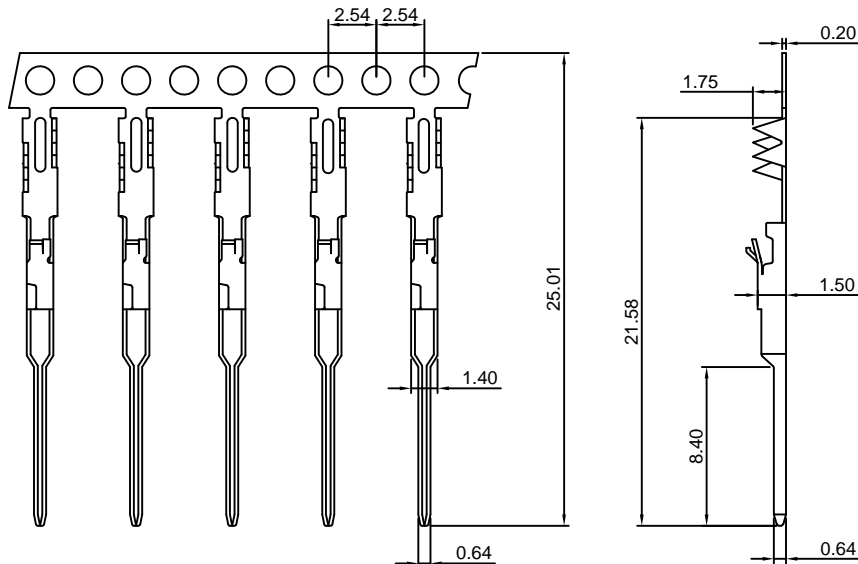

**Ordering information & Specifications:**

Unit:mm

Part NO.	Wire Range	Insulation O.D.	Material	Finish	Qty/reel
A2550M-TP-D	FFC WIRE	-----	Phosphor Bronze	Tin over Nickel	10,000 PCS
A2550M-GP-D	FFC WIRE	-----	Phosphor Bronze	Gold over Nickel	10,000 PCS

Optional Gold plating available but MOQ requested

### A2550M-T-E

2.54mm pitch Crimp Flex Terminal

**Reference Informations:**

\*Used in FFC Wire

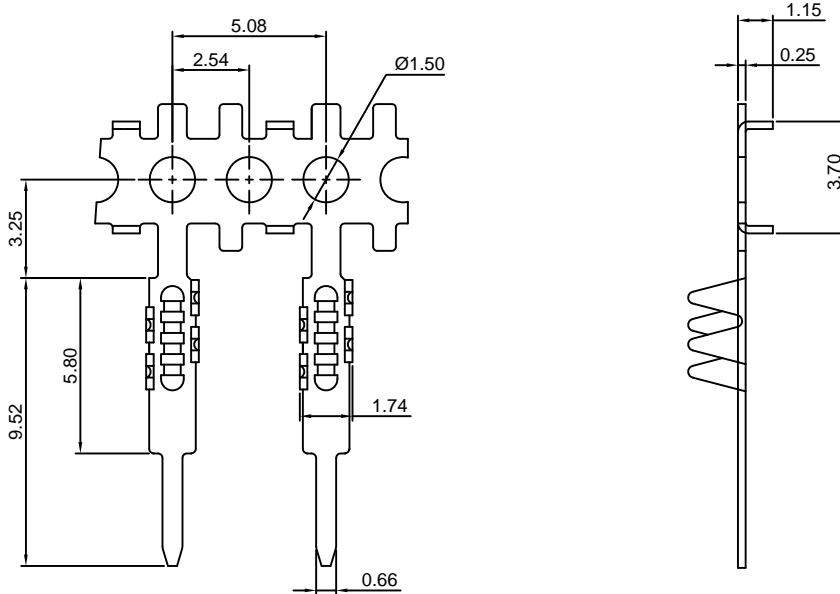

Ordering information & Specifications:

Unit:mm

Part NO.	Wire Range	Insulation O.D.	Material	Finish	Qty/reel
A2550M-TP-E	FFC WIRE	-----	Phosphor Bronze	Tin over Nickel	10,000 PCS
A2550M-GP-E	FFC WIRE	-----	Phosphor Bronze	Gold over Nickel	10,000 PCS

Optional Gold plating available but MOQ requested

### A2550M-T-KE

2.54mm pitch Crimp Flex Terminal

**Reference Informations:**

\*Used in FFC Wire

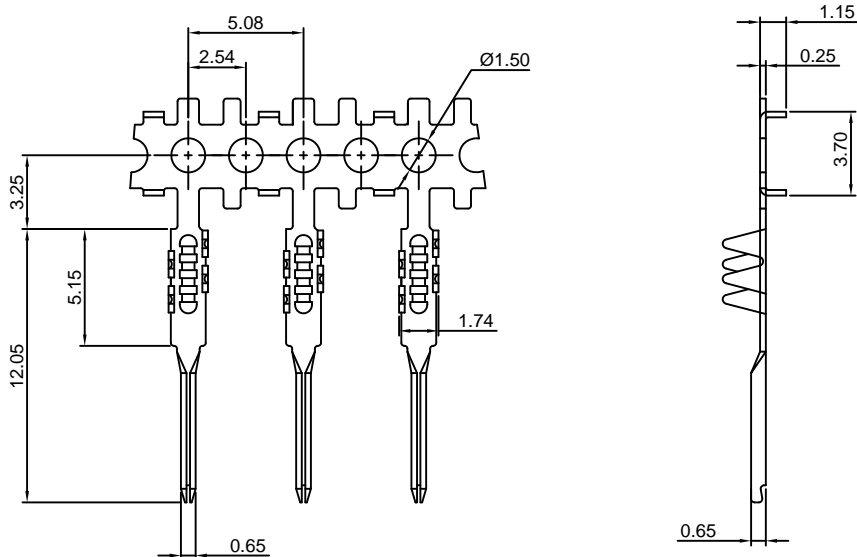

Ordering information & Specifications:

Unit:mm

Part NO.	Wire Range	Insulation O.D.	Material	Finish	Qty/reel
A2550M-TP-KE	FFC WIRE	-----	Phosphor Bronze	Tin over Nickel	20,000 PCS
A2550M-GP-KE	FFC WIRE	-----	Phosphor Bronze	Gold over Nickel	20,000 PCS

Optional Gold plating available but MOQ requested

### A2550M-T-F

2.54mm pitch Crimp Flex Terminal

**Reference Informations:**

\*Used in FFC Wire

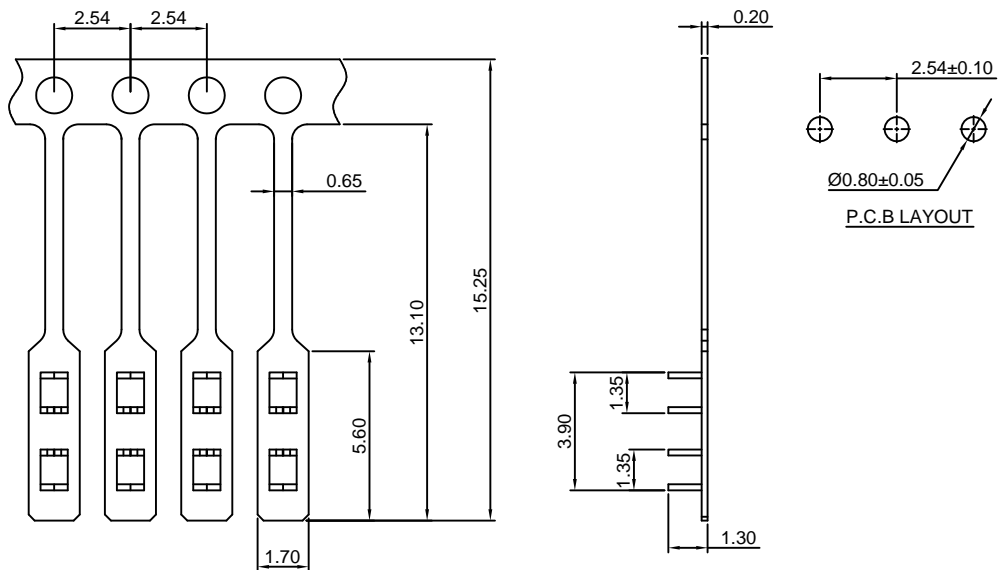

**Ordering information & Specifications:**

Unit:mm

Part NO.	Wire Range	Insulation O.D.	Material	Finish	Qty/reel
A2550M-TP-F	FFC WIRE	-----	Phosphor Bronze	Tin over Nickel	20,000 PCS
A2550M-GP-F	FFC WIRE	-----	Phosphor Bronze	Gold over Nickel	20,000 PCS

Optional Gold plating available but MOQ requested

### A2550M-T-G

2.54mm pitch Crimp Flex Terminal

**Reference Informations:**

\*Used in FFC Wire

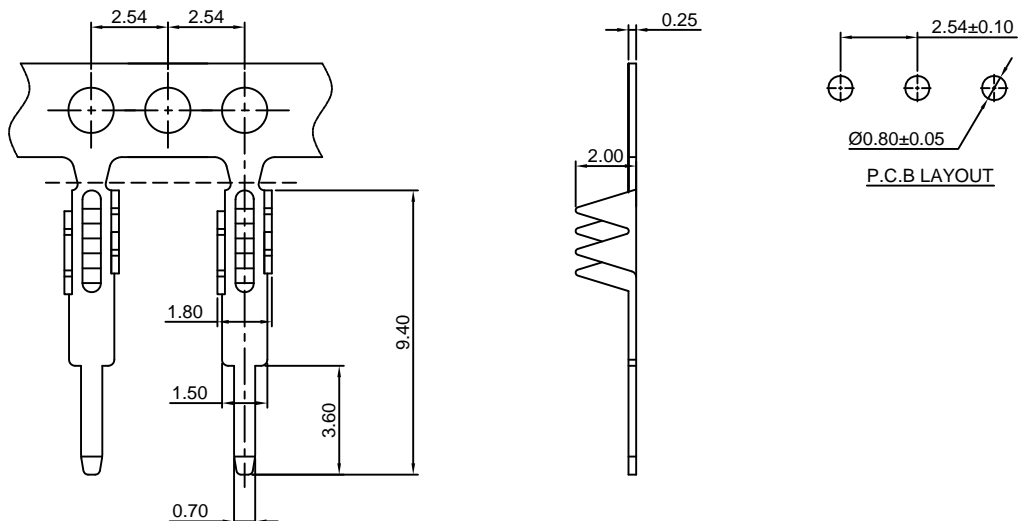

**Ordering information & Specifications:**

Unit:mm

Part NO.	Wire Range	Insulation O.D.	Material	Finish	Qty/reel
A2550M-TP-G	FFC WIRE	-----	Phosphor Bronze	Tin over Nickel	20,000 PCS
A2550M-GP-G	FFC WIRE	-----	Phosphor Bronze	Gold over Nickel	20,000 PCS

Optional Gold plating available but MOQ requested

### A2550M-T-J

2.54mm pitch Crimp Flex Terminal

**Reference Informations:**

\*Used in FFC Wire

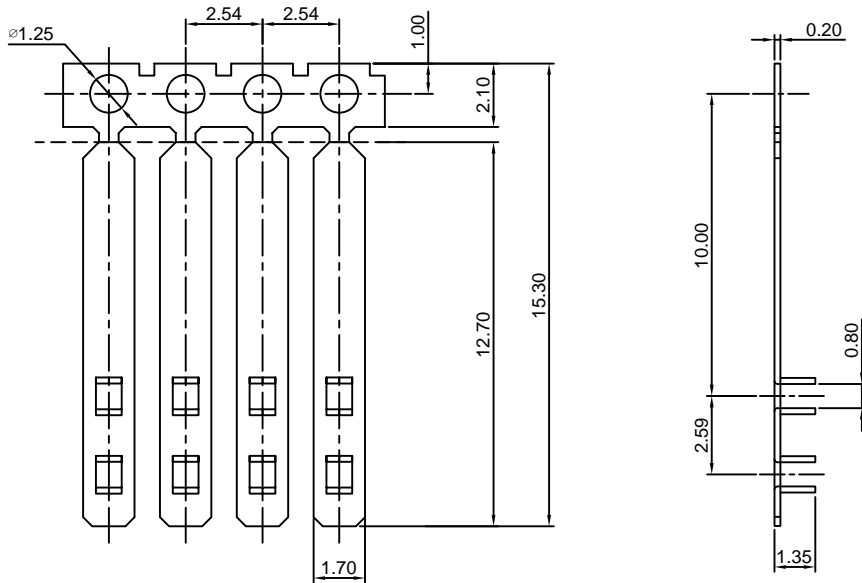

Ordering information & Specifications:

Unit:mm

Part NO.	Wire Range	Insulation O.D.	Material	Finish	Qty/reel
A2550M-TP-J	FFC WIRE	-----	Phosphor Bronze	Tin over Nickel	20,000 PCS
A2550M-GP-J	FFC WIRE	-----	Phosphor Bronze	Gold over Nickel	20,000 PCS

Optional Gold plating available but MOQ requested

### A2550M-T-K

2.54mm pitch Crimp Flex Terminal

**Reference Informations:**

\*Used in FFC Wire

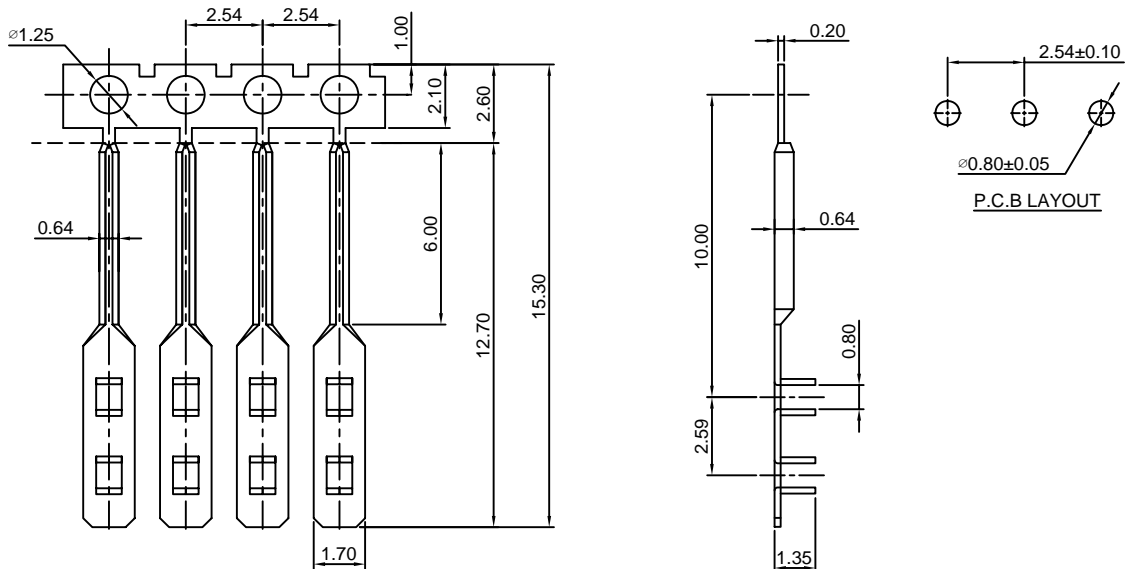

Ordering information & Specifications:

Unit:mm

Part NO.	Wire Range	Insulation O.D.	Material	Finish	Qty/reel
A2550M-TP-K	FFC WIRE	-----	Phosphor Bronze	Tin over Nickel	20,000 PCS
A2550M-GP-K	FFC WIRE	-----	Phosphor Bronze	Gold over Nickel	20,000 PCS

Optional Gold plating available but MOQ requested

### A2550H-XP

2.54mm Pitch Crimp Flex Housing

**Reference Informations:**

- \*Material:PBT30%GF,UL94V-0
- \*Suitable CJT A2550 series Terminal (A2550-T(-H), A2550-T(-H)-CR, A2550-T-A, A2550-T-C, A2550M-T)
- \*Mates with CJT A2541 series Wafer
- \*Color:Black

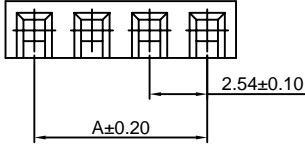
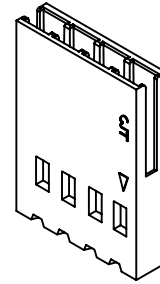

Ordering Information:  
A2550H-XP - \*\*\*  
 1 2  
 1.Part No.  
 2.Material:  
 (blank):PBT30%GF,UL94V-0  
 GWT:PBT,UL94V-0,GWT 750°C

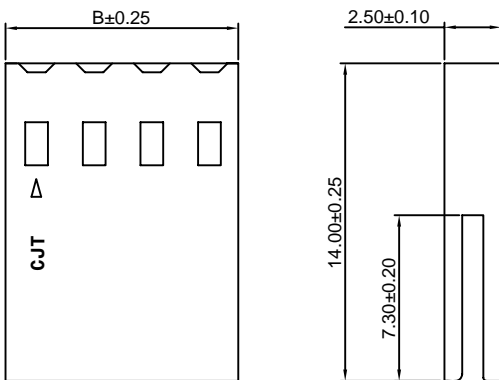

**Ordering Information & Dimensions:**

PART NO.	Dimensions		PART NO.	Dimensions	
	A	B		A	B
2P	2.54	5.08	20P	48.26	50.80
3P	5.08	7.62	21P	50.80	53.34
4P	7.62	10.16	22P	53.34	55.88
5P	10.16	12.70	23P	55.88	58.42
6P	12.70	15.24	24P	58.42	60.96
7P	15.24	17.78	25P	60.96	63.50
8P	17.78	20.32	26P	63.50	66.04
9P	20.32	22.86	27P	66.04	68.58
10P	22.86	25.40	28P	68.58	71.12
11P	25.40	27.94	29P	71.12	73.66
12P	27.94	30.48	30P	73.66	76.20
13P	30.48	33.02	31P	76.20	78.74
14P	33.02	35.56	32P	78.74	81.28
15P	35.56	38.10	33P	81.28	83.82
16P	38.10	40.64	34P	83.82	86.36
17P	40.64	43.18	35P	86.36	88.90
18P	43.18	45.72	36P	88.90	91.44
19P	45.72	48.26			

Unit: mm

### A2550HH-XP

2.54mm Pitch Crimp Flex Housing

**Reference Informations:**

- \*Material:PBT30%GF,UL94V-0
- \*Suitable CJT A2550 series Terminal (A2550-T(-H), A2550-T(-H)-CR, A2550-T-A, A2550-T-C, A2550M-T)
- \*Mates with CJT A2541 series Wafer
- \*Color:Black

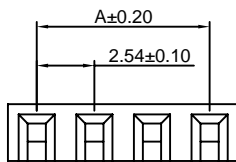
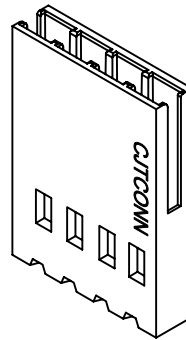

Ordering Information:  
A2550HH-XP - \*\*\*  
 1 2  
 1.Part No.  
 2.Material:  
 (blank):PBT30%GF,UL94V-0  
 GWT:PBT,UL94V-0,GWT 750°C

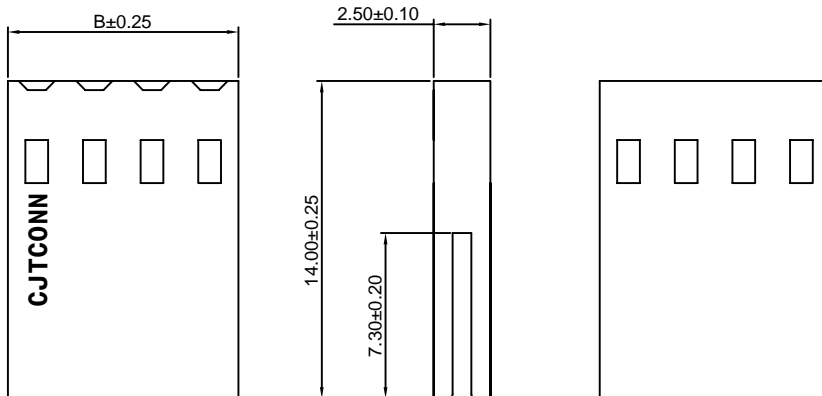

**Ordering Information & Dimensions:**

PART NO.	Dimensions	
	A	B
2P	2.54	5.08
3P	5.08	7.62
4P	7.62	10.16
5P	10.16	12.70
6P	12.70	15.24
7P	15.24	17.78
8P	17.78	20.32
9P	20.32	22.86
10P	22.86	25.40
11P	25.40	27.94
12P	27.94	30.48
13P	30.48	33.02
14P	33.02	35.56
15P	35.56	38.10
16P	38.10	40.64
17P	40.64	43.18
18P	43.18	45.72
19P	45.72	48.26
20P	48.26	50.80
21P	50.80	53.34
22P	53.34	55.88
23P	55.88	58.42
24P	58.42	60.96
25P	60.96	63.50

Unit: mm

### A2550HA-XP

2.54mm Pitch Crimp Flex Housing

**Reference Informations:**

- \*Material:PBT30%GF,UL94V-0
- \*Suitable CJT A2550 series Terminal (A2550-T(-H), A2550-T(-H)-CR, A2550-T-A, A2550-T-C,)
- \*Mates with CJT A2549WVB,WRB-XP series Wafer
- \*Color:Black

**Ordering Information:**

- A2550HA-XP - \*\*\*  
 1                                      2
- 1.Part No.  
 2.Material:  
 (blank):PBT30%GF,UL94V-0  
GWT:PBT,UL94V-0,GWT 750°C

**Ordering Information & Dimensions:**

PART NO.	Dimensions	
	A	B
2P	2.54	5.08
3P	5.08	7.62
4P	7.62	10.16
5P	10.16	12.70
6P	12.70	15.24
7P	15.24	17.78
8P	17.78	20.32
9P	20.32	22.86
10P	22.86	25.40
11P	25.40	27.94
12P	27.94	30.48
13P	30.48	33.02
14P	33.02	35.56
15P	35.56	38.10
16P	38.10	40.64
17P	40.64	43.18
18P	43.18	45.72
19P	45.72	48.26
20P	48.26	50.80
21P	50.80	53.34
22P	53.34	55.88
23P	55.88	58.42
24P	58.42	60.96
25P	60.96	63.50

Unit: mm

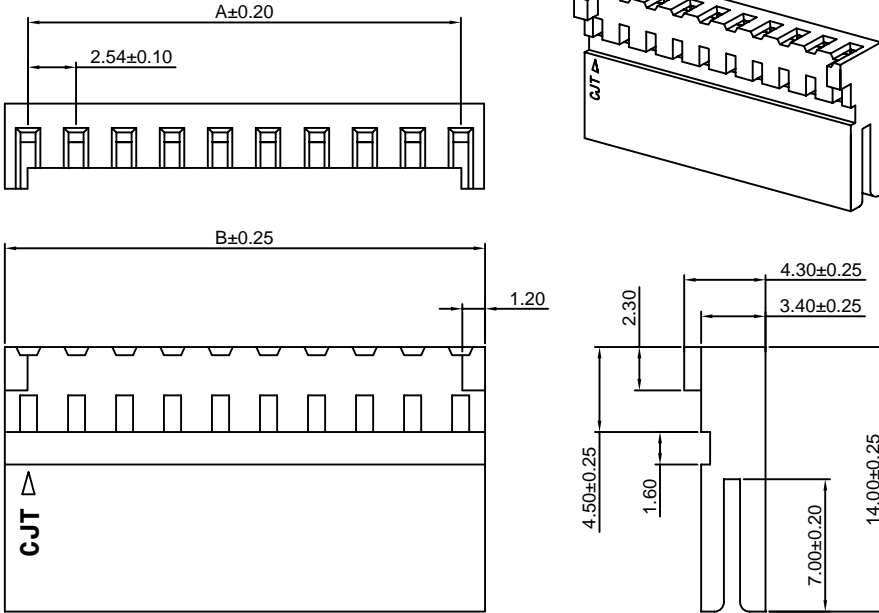

### A2550HB-XP

2.54mm Pitch Crimp Flex Housing

**Reference Informations:**

- \*Material:PBT30%GF,UL94V-0
- \*Suitable CJT A2550 series Terminal (A2550-T(-H), A2550-T(-H)-CR, A2550-T-A, A2550-T-C,)
- \*Mates with CJT A2549WVB,WRB-XP series Wafer
- \*Color:Black

**Ordering Information:**

- A2550HB-XP - \*\*\*  
 1                                      2
- 1.Part No.  
 2.Material:  
 (blank):PBT30%GF,UL94V-0  
GWT:PBT,UL94V-0,GWT 750°C

**Ordering Information & Dimensions:**

PART NO.	Dimensions	
	A	B
2P	2.54	5.08
3P	5.08	7.62
4P	7.62	10.16
5P	10.16	12.70
6P	12.70	15.24
7P	15.24	17.78
8P	17.78	20.32
9P	20.32	22.86
10P	22.86	25.40
11P	25.40	27.94
12P	27.94	30.48
13P	30.48	33.02
14P	33.02	35.56
15P	35.56	38.10
16P	38.10	40.64
17P	40.64	43.18
18P	43.18	45.72
19P	45.72	48.26
20P	48.26	50.80
21P	50.80	53.34
22P	53.34	55.88
23P	55.88	58.42
24P	58.42	60.96
25P	60.96	63.50

Unit: mm

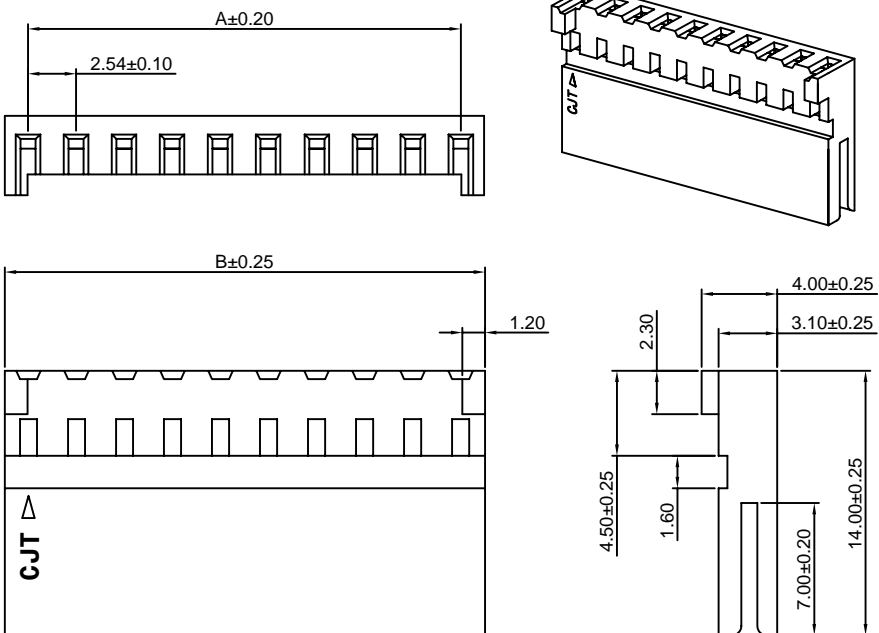

### A2550H-XP-A

2.54mm Pitch Crimp Flex Housing

**Reference Informations:**

- \*Material: PBT30%GF, UL94V-0
- \*Suitable CJT A2550 series Terminal (A2550-T(-H), A2550-T(-H)-CR, A2550-T-A, A2550-T-C)
- \*Mates with CJT A2550HM-XP, A2547HM-XP series Housing or A2547WVA, WRA-XP series Wafer
- \*Color: Black

**Ordering Information:**

- A2550H-XP-A - \*\*\*
- 1                  2
1. Part No.
  2. Material:  
(blank): PBT30%GF, UL94V-0  
GWT: PBT, UL94V-0, GWT 750°C

**Ordering Information & Dimensions:**

PART NO.	Dimensions	
	A	B
2P	2.54	5.08
3P	5.08	7.62
4P	7.62	10.16
5P	10.16	12.70
6P	12.70	15.24
7P	15.24	17.78
8P	17.78	20.32
9P	20.32	22.86
10P	22.86	25.40
11P	25.40	27.94
12P	27.94	30.48
13P	30.48	33.02
14P	33.02	35.56
15P	35.56	38.10
16P	38.10	40.64
17P	40.64	43.18
18P	43.18	45.72
19P	45.72	48.26
20P	48.26	50.80
21P	50.80	53.34
22P	53.34	55.88
23P	55.88	58.42
24P	58.42	60.96
25P	60.96	63.50

Unit: mm

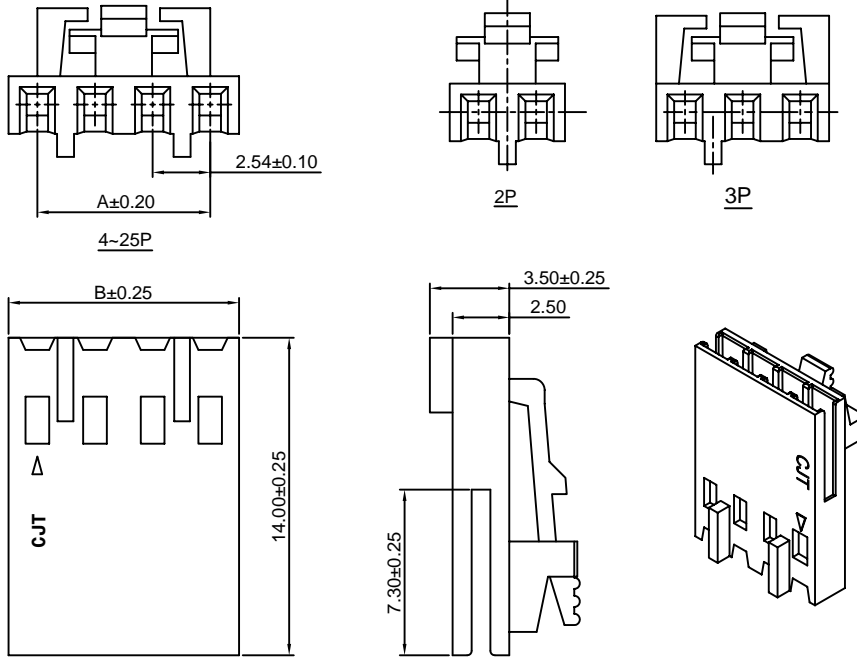

### A2550H-XP-A1

2.54mm Pitch Crimp Flex Housing

**Reference Informations:**

- \*Material: PBT30%GF, UL94V-0
- \*Suitable CJT A2550 series Terminal (A2550-T(-H), A2550-T(-H)-CR, A2550-T-A, A2550-T-C)
- \*Mates with CJT A2550HM-XP, A2547HM-XP series Housing or A2547WVA, WRA-XP series Wafer
- \*Color: Black

**Ordering Information:**

- A2550H-XP-A1 - \*\*\*
- 1                  2
1. Part No.
  2. Material:  
(blank): PBT30%GF, UL94V-0  
GWT: PBT, UL94V-0, GWT 750°C

**Ordering Information & Dimensions:**

PART NO.	Dimensions	
	A	B
2P	2.54	5.08
3P	5.08	7.62
4P	7.62	10.16
5P	10.16	12.70
6P	12.70	15.24
7P	15.24	17.78
8P	17.78	20.32
9P	20.32	22.86
10P	22.86	25.40
11P	25.40	27.94
12P	27.94	30.48
13P	30.48	33.02
14P	33.02	35.56
15P	35.56	38.10
16P	38.10	40.64
17P	40.64	43.18
18P	43.18	45.72
19P	45.72	48.26
20P	48.26	50.80
21P	50.80	53.34
22P	53.34	55.88
23P	55.88	58.42
24P	58.42	60.96
25P	60.96	63.50

Unit: mm

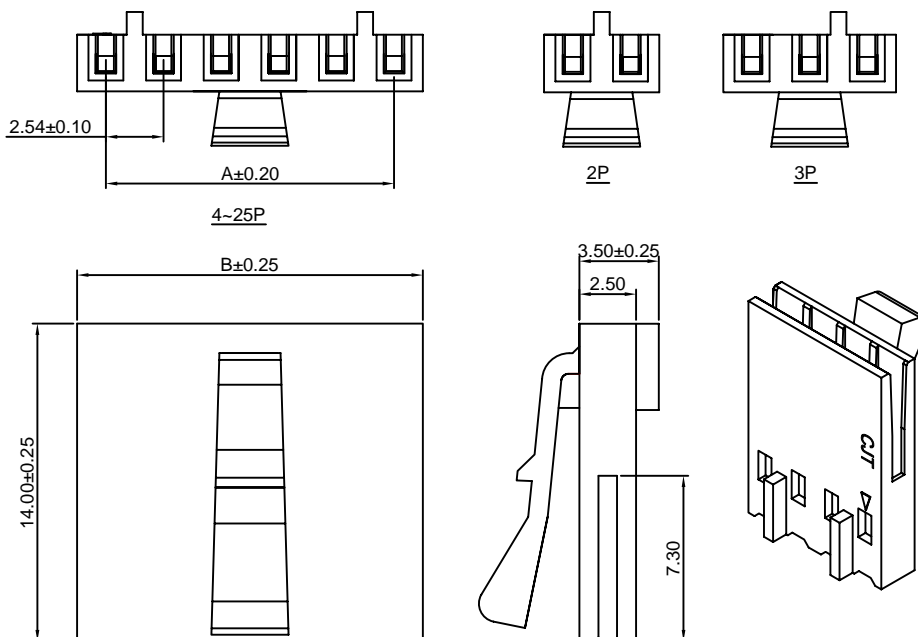



### A2550H-XP-A2

2.54mm Pitch Crimp Flex Housing

**Reference Informations:**

- \*Material:PBT30%GF,UL94V-0
- \*Suitable CJT A2550 series Terminal (A2550-T(-H), A2550-T(-H)-CR, A2550-T-A, A2550-T-C)
- \*Mates with CJT A2550HM-XP, A2547HM-XP series Housing or A2547WVA, WRA-XP series Wafer
- \*Color:Black

**Ordering Information:**

- A2550H-XP-A2 - \*\*\*  
 1            2  
 1.Part No.  
 2.Material:  
 (blank):PBT30%GF,UL94V-0  
 GWT:PBT,UL94V-0,GWT 750°C

**Ordering Information & Dimensions:**

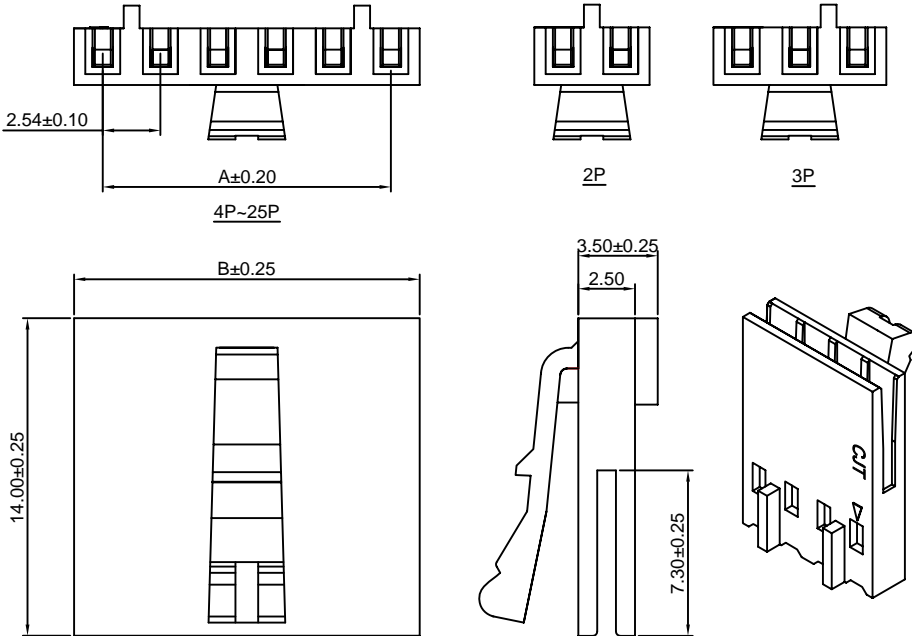

PART NO.	Dimensions	
	A	B
2P	2.54	5.08
3P	5.08	7.62
4P	7.62	10.16
5P	10.16	12.70
6P	12.70	15.24
7P	15.24	17.78
8P	17.78	20.32
9P	20.32	22.86
10P	22.86	25.40
11P	25.40	27.94
12P	27.94	30.48
13P	30.48	33.02
14P	33.02	35.56
15P	35.56	38.10
16P	38.10	40.64
17P	40.64	43.18
18P	43.18	45.72
19P	45.72	48.26
20P	48.26	50.80
21P	50.80	53.34
22P	53.34	55.88
23P	55.88	58.42
24P	58.42	60.96
25P	60.96	63.50

Unit: mm

### A2550H-XP-A2H

2.54mm Pitch Crimp Flex Housing

**Reference Informations:**

- \*Material:PBT30%GF,UL94V-0
- \*Suitable CJT A2550 series Terminal (A2550-T(-H), A2550-T(-H)-CR, A2550-T-A, A2550-T-C)
- \*Mates with CJT A2550HM-XP, A2547HM-XP series Housing or A2547WVA, WRA-XP series Wafer
- \*Color:Black

**Ordering Information:**

- A2550H-XP-A2H - \*\*\*  
 1            2  
 1.Part No.  
 2.Material:  
 (blank):PBT30%GF,UL94V-0  
 GWT:PBT,UL94V-0,GWT 750°C

**Ordering Information & Dimensions:**

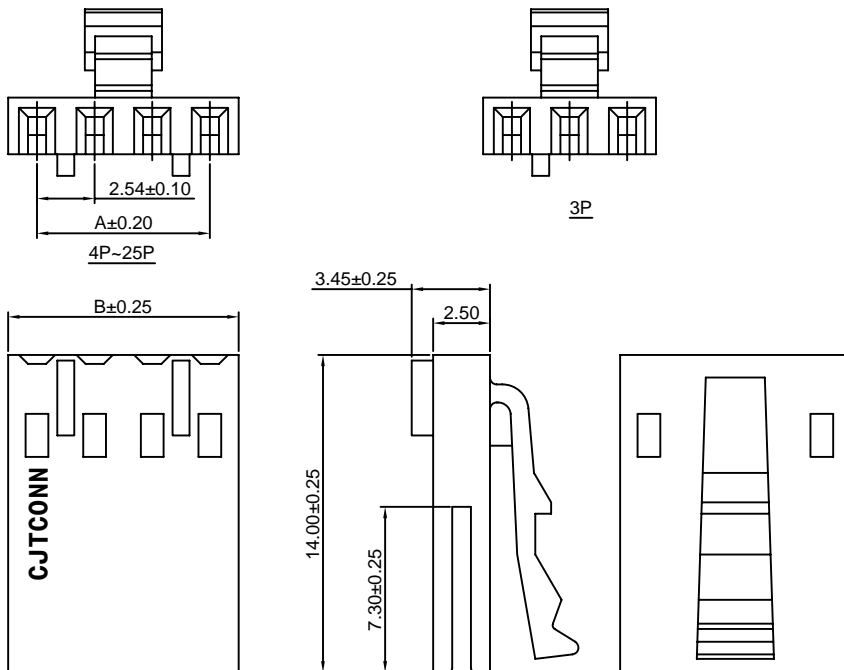

PART NO.	Dimensions	
	A	B
3P	5.08	7.62
4P	7.62	10.16
5P	10.16	12.70
6P	12.70	15.24
7P	15.24	17.78
8P	17.78	20.32
9P	20.32	22.86
10P	22.86	25.40
11P	25.40	27.94
12P	27.94	30.48
13P	30.48	33.02
14P	33.02	35.56
15P	35.56	38.10
16P	38.10	40.64
17P	40.64	43.18
18P	43.18	45.72
19P	45.72	48.26
20P	48.26	50.80
21P	50.80	53.34
22P	53.34	55.88
23P	55.88	58.42
24P	58.42	60.96
25P	60.96	63.50

Unit: mm

### A2550H-XP-A3

2.54mm Pitch Crimp Flex Housing

**Reference Informations:**

- \*Material: PBT30%GF,UL94V-0
- \*Suitable CJT A2550 series Terminal (A2550-T(-H), A2550-T(-H)-CR, A2550-T-A, A2550-T-C)
- \*Mates with CJT A2550HM-XP,A2547HM-XP series Housing or A2547WVA,WRA-XP series Wafer
- \*Color:Black

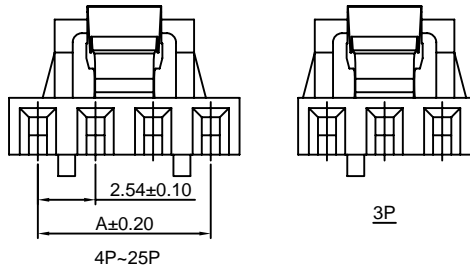

Ordering Information:  
A2550H-XP-A3 - \*\*\*  
 1 2  
 1.Part No.  
 2.Material:  
 (blank):PBT30%GF,UL94V-0  
 GWT:PBT,UL94V-0,GWT 750°C

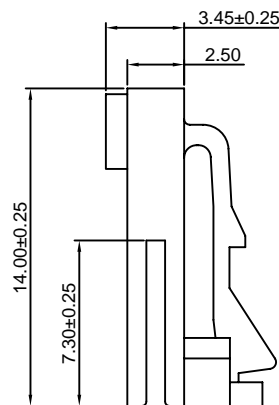
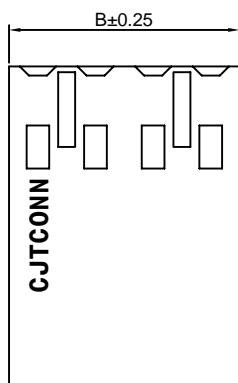

**Ordering Information & Dimensions:**

PART NO.	Dimensions	
	A	B
3P	5.08	7.62
4P	7.62	10.16
5P	10.16	12.70
6P	12.70	15.24
7P	15.24	17.78
8P	17.78	20.32
9P	20.32	22.86
10P	22.86	25.40
11P	25.40	27.94
12P	27.94	30.48
13P	30.48	33.02
14P	33.02	35.56
15P	35.56	38.10
16P	38.10	40.64
17P	40.64	43.18
18P	43.18	45.72
19P	45.72	48.26
20P	48.26	50.80
21P	50.80	53.34
22P	53.34	55.88
23P	55.88	58.42
24P	58.42	60.96
25P	60.96	63.50

Unit: mm

### A2550H-XP-A3H

2.54mm Pitch Crimp Flex Housing

**Reference Informations:**

- \*Material:PBT30%GF,UL94V-0
- \*Suitable CJT A2550 series Terminal (A2550-T(-H), A2550-T(-H)-CR, A2550-T-A, A2550-T-C)
- \*Mates with CJT A2550HM-XP, A2547HM-XP series Housing or A2547WVA,WRA-XP series Wafer
- \*Color:Black

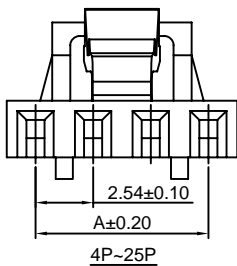

Ordering Information:  
A2550H-XP-A3H - \*\*\*  
 1 2  
 1.Part No.  
 2.Material:  
 (blank):PBT30%GF,UL94V-0  
 GWT:PBT,UL94V-0,GWT 750°C

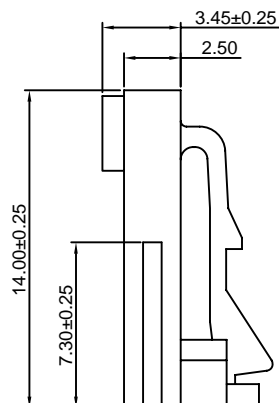
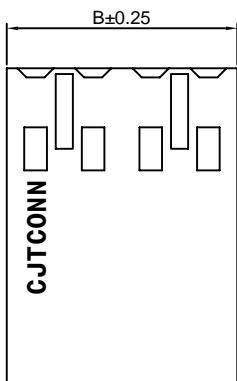
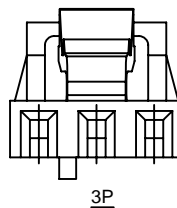

**Ordering Information & Dimensions:**

PART NO.	Dimensions	
	A	B
3P	5.08	7.62
4P	7.62	10.16
5P	10.16	12.70
6P	12.70	15.24
7P	15.24	17.78
8P	17.78	20.32
9P	20.32	22.86
10P	22.86	25.40
11P	25.40	27.94
12P	27.94	30.48
13P	30.48	33.02
14P	33.02	35.56
15P	35.56	38.10
16P	38.10	40.64
17P	40.64	43.18
18P	43.18	45.72
19P	45.72	48.26
20P	48.26	50.80
21P	50.80	53.34
22P	53.34	55.88
23P	55.88	58.42
24P	58.42	60.96
25P	60.96	63.50

Unit: mm

### A2550H-XP-B

2.54mm Pitch Crimp Flex Housing

**Reference Informations:**

- \*Material:PBT30%GF,UL94V-0
- \*Suitable CJT A2550 series Terminal (A2550-T(H), A2550-T(H)-CR, A2550-T-A, A2550-T-C)
- \*Mates with CJT A2547HMA-XP series Housing or A2547 series Wafer
- \*Color:Black

**Ordering Information:**

A2550H-XP-B - \*\*\*  
1 2

- 1.Part No.
- 2.Material:

(blank):PBT30%GF,UL94V-0  
GWT:PBT,UL94V-0,GWT 750 °C

**Ordering Information & Dimensions:**

PART NO.	Dimensions	
	A	B
2P	2.54	5.08
3P	5.08	7.62
4P	7.62	10.16
5P	10.16	12.70
6P	12.70	15.24
7P	15.24	17.78
8P	17.78	20.32
9P	20.32	22.86
10P	22.86	25.40
11P	25.40	27.94
12P	27.94	30.48
13P	30.48	33.02
14P	33.02	35.56
15P	35.56	38.10
16P	38.10	40.64
17P	40.64	43.18
18P	43.18	45.72
19P	45.72	48.26
20P	48.26	50.80
21P	50.80	53.34
22P	53.34	55.88
23P	55.88	58.42
24P	58.42	60.96
25P	60.96	63.50

Unit: mm

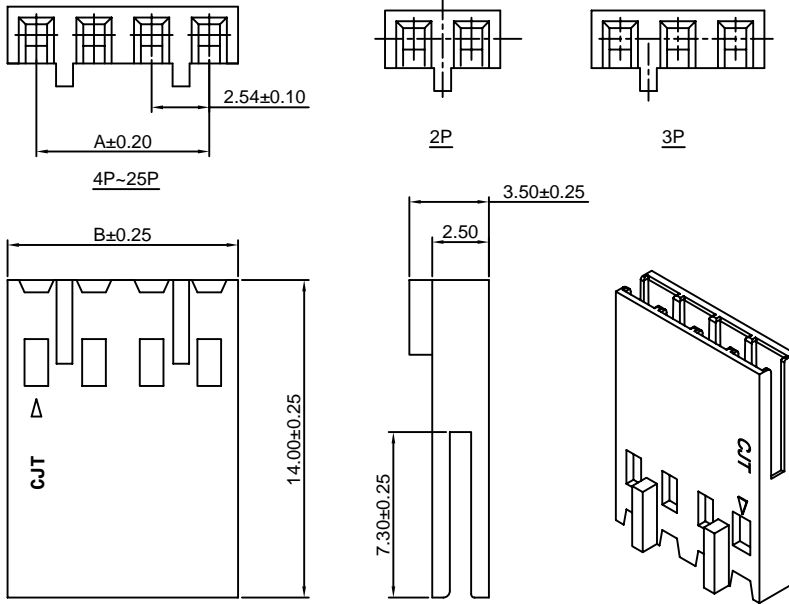

### A2550H-XP-BH

2.54mm Pitch Crimp Flex Housing

**Reference Informations:**

- \*Material:PBT30%GF,UL94V-0
- \*Suitable CJT A2550 series Terminal (A2550-T(H), A2550-T(H)-CR, A2550-T-A, A2550-T-C)
- \*Mates with CJT A2547HMA-XP series Housing or A2547 series Wafer
- \*Color:Black

**Ordering Information:**

A2550H-XP-BH - \*\*\*  
1 2

- 1.Part No.
- 2.Material:

(blank):PBT30%GF,UL94V-0  
GWT:PBT,UL94V-0,GWT 750 °C

**Ordering Information & Dimensions:**

PART NO.	Dimensions	
	A	B
2P	2.54	5.08
3P	5.08	7.62
4P	7.62	10.16
5P	10.16	12.70
6P	12.70	15.24
7P	15.24	17.78
8P	17.78	20.32
9P	20.32	22.86
10P	22.86	25.40
11P	25.40	27.94
12P	27.94	30.48
13P	30.48	33.02
14P	33.02	35.56
15P	35.56	38.10
16P	38.10	40.64
17P	40.64	43.18
18P	43.18	45.72
19P	45.72	48.26
20P	48.26	50.80
21P	50.80	53.34
22P	53.34	55.88
23P	55.88	58.42
24P	58.42	60.96
25P	60.96	63.50

Unit: mm

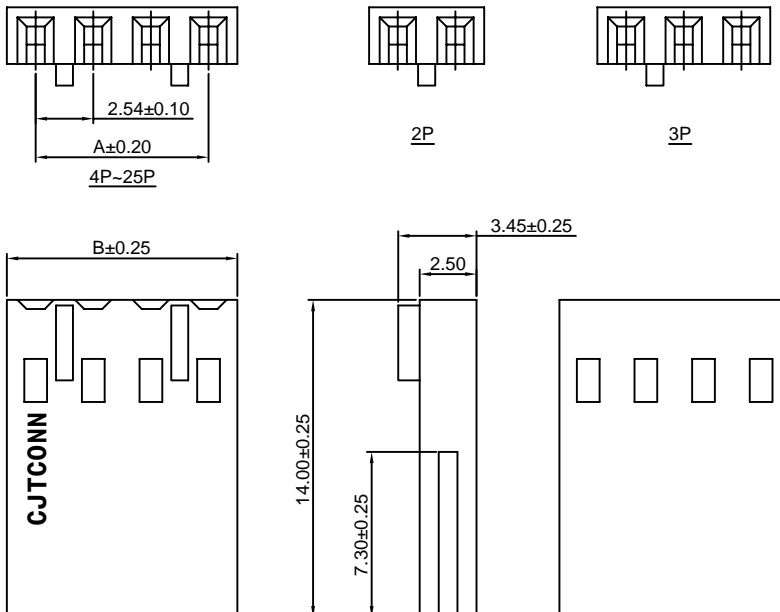

### A2550H-XP-C

2.54mm Pitch Crimp Flex Housing

**Reference Informations:**

- \*Material: PBT30%GF, UL94V-0
- \*Suitable CJT A2550 series Terminal (A2550-T(-H), A2550-T(-H)-CR, A2550-T-A, A2550-T-C)
- \*Mates with CJT A2547WVE, WRE-XP, A2549WV, WR-XP series Wafer
- \*Color: Black

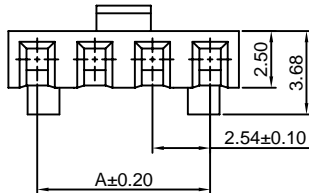

Ordering Information:  
A2550H-XP-C - \*\*\*  
 1                      2

1. Part No.  
 2. Material:  
 (blank): PBT30%GF, UL94V-0  
 GWT: PBT, UL94V-0, GWT 750°C

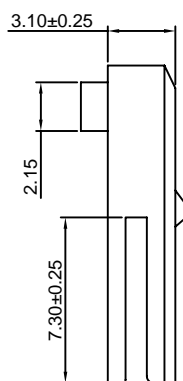
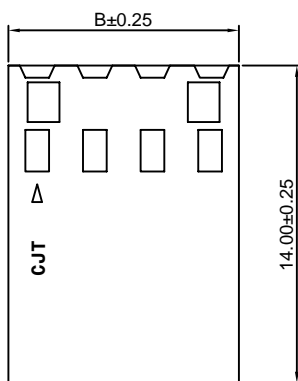
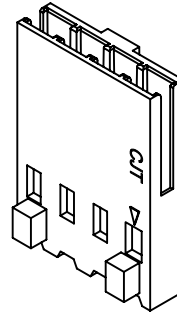

**Ordering Information & Dimensions:**

PART NO.	Dimensions	
	A	B
2P	2.54	5.08
3P	5.08	7.62
4P	7.62	10.16
5P	10.16	12.70
6P	12.70	15.24
7P	15.24	17.78
8P	17.78	20.32
9P	20.32	22.86
10P	22.86	25.40
11P	25.40	27.94
12P	27.94	30.48
13P	30.48	33.02
14P	33.02	35.56
15P	35.56	38.10
16P	38.10	40.64
17P	40.64	43.18
18P	43.18	45.72
19P	45.72	48.26
20P	48.26	50.80
21P	50.80	53.34
22P	53.34	55.88
23P	55.88	58.42
24P	58.42	60.96
25P	60.96	63.50

Unit: mm

### A2550H-XP-C1

2.54mm Pitch Crimp Flex Housing

**Reference Informations:**

- \*Material: PBT30%GF, UL94V-0
- \*Suitable CJT A2550 series Terminal (A2550-T(-H), A2550-T(-H)-CR, A2550-T-A, A2550-T-C)
- \*Mates with CJT A2547WVE, WRE-XP, A2549WV, WR-XP series Wafer
- \*Color: Black

Ordering Information:  
A2550H-XP-C1 - \*\*\*  
 1                      2

1. Part No.  
 2. Material:  
 (blank): PBT30%GF, UL94V-0  
 GWT: PBT, UL94V-0, GWT 750°C

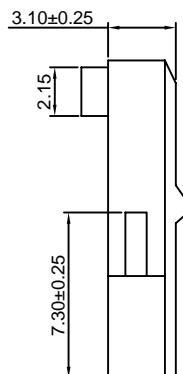
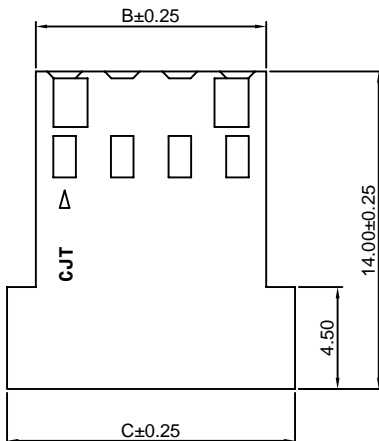
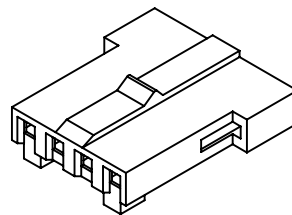
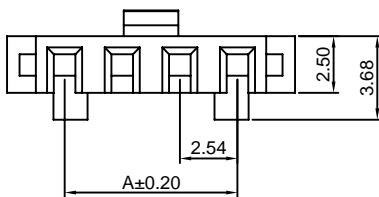

**Ordering Information & Dimensions:**

PART NO.	Dimensions		
	A	B	C
2P	2.54	5.08	7.62
3P	5.08	7.62	10.16
4P	7.62	10.16	12.70
5P	10.16	12.70	15.24
6P	12.70	15.24	17.78
7P	15.24	17.78	20.32
8P	17.78	20.32	22.86
9P	20.32	22.86	25.40
10P	22.86	25.40	27.94
11P	25.40	27.94	30.48
12P	27.94	30.48	33.02
13P	30.48	33.02	35.56
14P	33.02	35.56	38.10
15P	35.56	38.10	40.64
16P	38.10	40.64	43.18
17P	40.64	43.18	45.72
18P	43.18	45.72	48.26
19P	45.72	48.26	50.80
20P	48.26	50.80	53.34
21P	50.80	53.34	55.88
22P	53.34	55.88	58.42
23P	55.88	58.42	60.96
24P	58.42	60.96	63.50
25P	60.96	63.50	66.04

Unit: mm

### A2550H-XP-CH

2.54mm Pitch Crimp Flex Housing

#### Reference Informations:

- \*Material: PBT30%GF, UL94V-0
- \*Suitable CJT A2550 series Terminal (A2550-T(-H), A2550-T(-H)-CR, A2550-T-A, A2550-T-C)
- \*Mates with CJT A2547WVE, WRE-XP, A2549WV, WR-XP series Wafer
- \*Color: Black

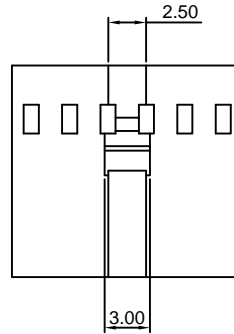
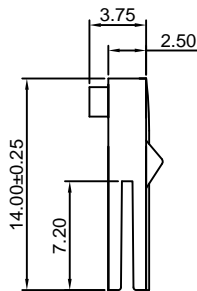
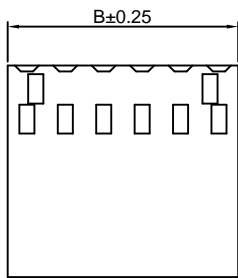
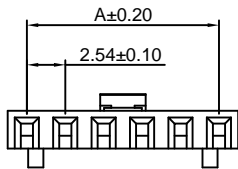

#### Ordering Information:

A2550H-XP-CH - \*\*\*  
 1 2  
 1. Part No.  
 2. Material:  
 (blank): PBT30%GF, UL94V-0  
 GWT: PBT, UL94V-0, GWT 750°C

#### Ordering Information & Dimensions:

PART NO.	Dimensions	
	A	B
2P	2.54	5.08
3P	5.08	7.62
4P	7.62	10.16
5P	10.16	12.70
6P	12.70	15.24
7P	15.24	17.78
8P	17.78	20.32
9P	20.32	22.86
10P	22.86	25.40
11P	25.40	27.94
12P	27.94	30.48
13P	30.48	33.02
14P	33.02	35.56
15P	35.56	38.10
16P	38.10	40.64
17P	40.64	43.18
18P	43.18	45.72
19P	45.72	48.26
20P	48.26	50.80
21P	50.80	53.34
22P	53.34	55.88
23P	55.88	58.42
24P	58.42	60.96
25P	60.96	63.50

Unit: mm

### A2550H-XP-D

2.54mm Pitch Crimp Flex Housing

#### Reference Informations:

- \*Material: PBT30%GF, UL94V-0
- \*Suitable CJT A2550 series Terminal (A2550-T(-H), A2550-T(-H)-CR, A2550-T-A, A2550M-T, A2550-T-C)
- \*Mates with CJT A2541 series Wafer
- \*Color: Blue

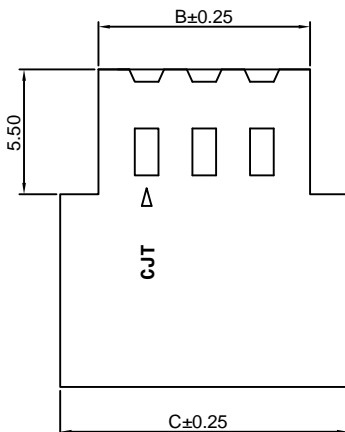
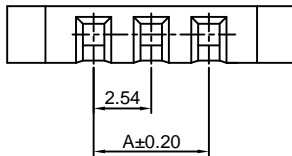

#### Ordering Information:

A2550H-XP-D - \*\*\*  
 1 2  
 1. Part No.  
 2. Material:  
 (blank): PBT30%GF, UL94V-0  
 GWT: PBT, UL94V-0, GWT 750°C

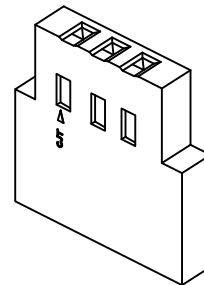
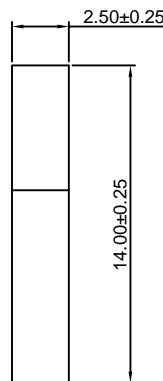

#### Ordering Information & Dimensions:

PART NO.	Dimensions			PART NO.	Dimensions		
	A	B	C		A	B	C
2P	2.54	6.81	10.16	20P	48.26	52.53	55.88
3P	5.08	9.35	12.70	21P	50.80	55.07	58.42
4P	7.62	11.89	15.24	22P	53.34	57.61	60.96
5P	10.16	14.43	17.78	23P	55.88	60.15	63.50
6P	12.70	16.97	20.32	24P	58.42	62.69	66.04
7P	15.24	19.51	22.86	25P	60.96	65.23	68.58
8P	17.78	22.05	25.40	26P	63.50	67.77	71.12
9P	20.32	24.59	27.94	27P	66.04	70.31	73.66
10P	22.86	27.13	30.48	28P	68.58	72.85	76.20
11P	25.40	29.67	33.02	29P	71.12	75.39	78.74
12P	27.94	32.21	35.56	30P	73.66	77.93	81.28
13P	30.48	34.75	38.10	31P	76.20	80.47	83.82
14P	33.02	37.29	40.64	32P	78.74	83.01	86.36
15P	35.56	39.83	43.18	33P	81.28	85.55	88.90
16P	38.10	42.37	45.72	34P	83.82	88.09	91.44
17P	40.64	44.91	48.26	35P	86.36	90.63	93.98
18P	43.18	47.45	50.80	36P	88.90	93.17	96.52
19P	45.72	49.99	53.34				

Unit: mm

### A2550H-XP-G

2.54mm Pitch Crimp Flex Housing

**Reference Informations:**

- \*Material:PBT30%GF,UL94V-0
- \*Suitable CJT A2550 series Terminal (A2550-T-J)
- \*Mates with CJT A2541 series Wafer
- \*Color:Black

**Ordering Information:**

A2550H-XP-G - \*\*\*  
1 2

1.Part No.

2.Material:

(blank):PBT30%GF,UL94V-0  
GWT:PBT,UL94V-0,GWT 750°C

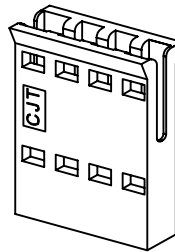
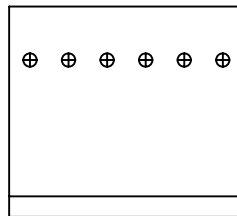
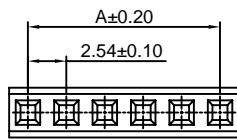
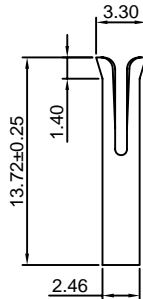
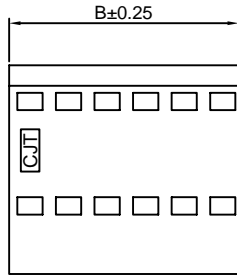

**Ordering Information & Dimensions:**

PART NO.	Dimensions		PART NO.	Dimensions	
	A	B		A	B
2P	2.54	4.92	19P	45.72	48.10
3P	5.08	7.46	20P	48.26	50.64
4P	7.62	10.00	21P	50.80	53.18
5P	10.16	12.54	22P	53.34	55.72
6P	12.70	15.08	23P	55.88	58.26
7P	15.24	17.62	24P	58.42	60.80
8P	17.78	20.16	25P	60.96	63.34
9P	20.32	22.70	26P	63.50	65.88
10P	22.86	25.24	27P	66.04	68.42
11P	25.40	27.78	28P	68.58	70.96
12P	27.94	30.32	29P	71.12	73.50
13P	30.48	32.86	30P	73.66	76.04
14P	33.02	35.40	31P	76.20	78.58
15P	35.56	37.94	32P	78.74	81.12
16P	38.10	40.48	33P	81.28	83.66
17P	40.64	43.02	34P	83.82	86.20
18P	43.18	45.56			

Unit: mm

### A2550H-XP-G1

2.54mm Pitch Crimp Flex Housing

**Reference Informations:**

- \*Material:PBT30%GF,UL94V-0
- \*Suitable CJT A2550 series Terminal (A2550-T-J)
- \*Mates with CJT A2541 series Wafer
- \*Color:Black

**Ordering Information:**

A2550H-XP-G1 - \*\*\*  
1 2

1.Part No.

2.Material:

(blank):PBT30%GF,UL94V-0  
GWT:PBT,UL94V-0,GWT 750°C

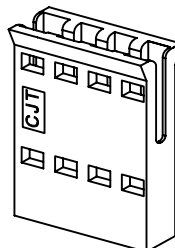
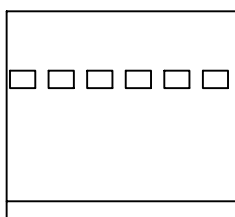
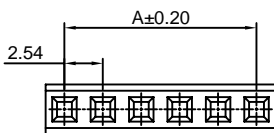
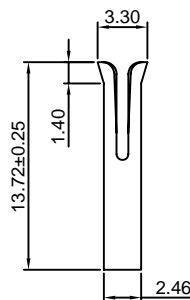
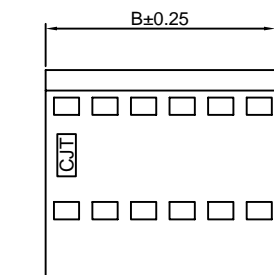

**Ordering Information & Dimensions:**

PART NO.	Dimensions		PART NO.	Dimensions	
	A	B		A	B
2P	2.54	4.92	19P	45.72	48.10
3P	5.08	7.46	20P	48.26	50.64
4P	7.62	10.00	21P	50.80	53.18
5P	10.16	12.54	22P	53.34	55.72
6P	12.70	15.08	23P	55.88	58.26
7P	15.24	17.62	24P	58.42	60.80
8P	17.78	20.16	25P	60.96	63.34
9P	20.32	22.70	26P	63.50	65.88
10P	22.86	25.24	27P	66.04	68.42
11P	25.40	27.78	28P	68.58	70.96
12P	27.94	30.32	29P	71.12	73.50
13P	30.48	32.86	30P	73.66	76.04
14P	33.02	35.40	31P	76.20	78.58
15P	35.56	37.94	32P	78.74	81.12
16P	38.10	40.48	33P	81.28	83.66
17P	40.64	43.02	34P	83.82	86.20
18P	43.18	45.56			

Unit: mm

### A2550H-XP-H

2.54mm Pitch Crimp Flex Housing

**Reference Informations:**

- \*Material:PBT30%GF,UL94V-0
- \*Suitable CJT A2550 series Terminal (A2550-T-J)
- \*Mates with CJT A2547 series Wafer
- \*Color:Black

**Ordering Information:**

- A2550H-XP-H - \*\*\*  
 $\frac{1}{2}$
- 1.Part No.
  - 2.Material:  
 (blank):PBT30%GF,UL94V-0  
 GWT:PBT,UL94V-0,GWT 750°C

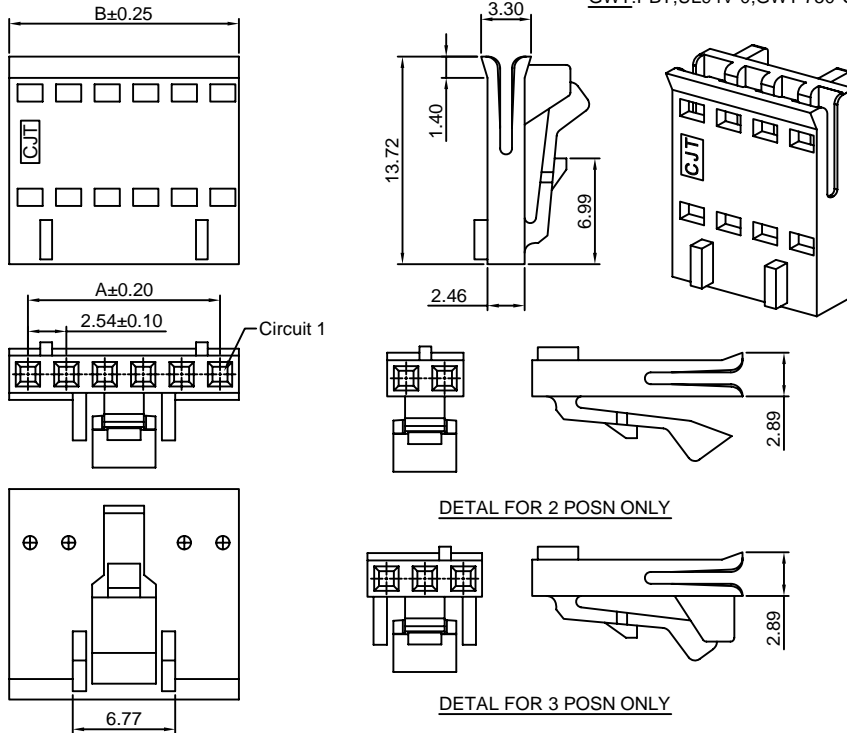

**Ordering Information & Dimensions:**

PART NO.	Dimensions	
	A	B
2P	2.54	4.92
3P	5.08	7.46
4P	7.62	10.00
5P	10.16	12.54
6P	12.70	15.08
7P	15.24	17.62
8P	17.78	20.16
9P	20.32	22.70
10P	22.86	25.24
11P	25.40	27.78
12P	27.94	30.32
13P	30.48	32.86
14P	33.02	35.40
15P	35.56	37.94
16P	38.10	40.48
17P	40.64	43.02
18P	43.18	45.56
19P	45.72	48.10
20P	48.26	50.64
21P	50.80	53.18
22P	53.34	55.72
23P	55.88	58.26
24P	58.42	60.80
25P	60.96	63.34

Unit: mm

### A2550H-XP-H1

2.54mm Pitch Crimp Flex Housing

**Reference Informations:**

- \*Material:PBT30%GF,UL94V-0
- \*Suitable CJT A2550 series Terminal (A2550-T-J)
- \*Mates with CJT A2547 series Wafer
- \*Color:Black

**Ordering Information:**

- A2550H-XP-H1 - \*\*\*  
 $\frac{1}{2}$
- 1.Part No.
  - 2.Material:  
 (blank):PBT30%GF,UL94V-0  
 GWT:PBT,UL94V-0,GWT 750°C

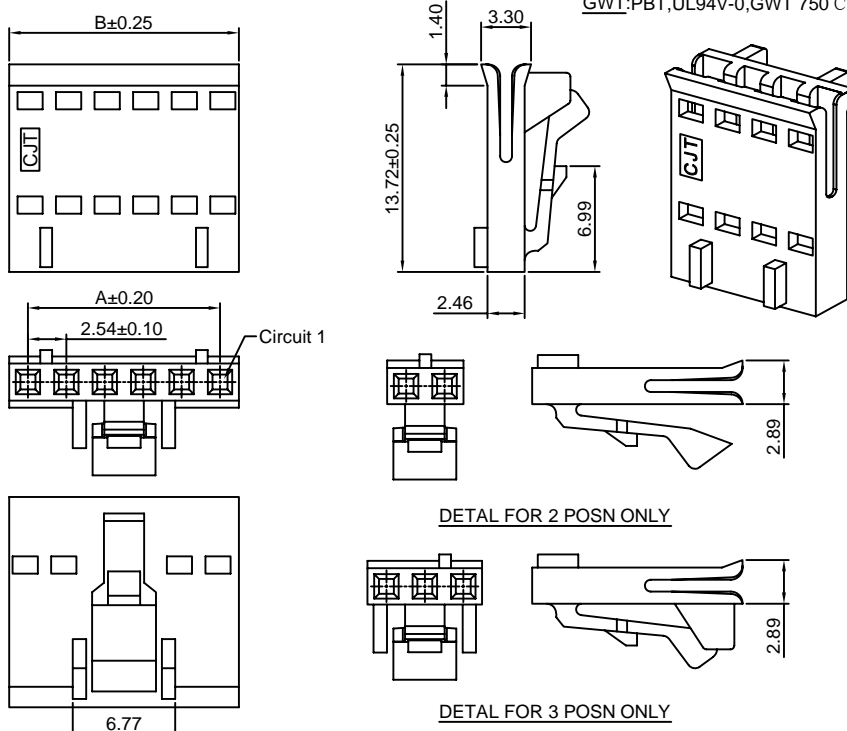

**Ordering Information & Dimensions:**

PART NO.	Dimensions	
	A	B
2P	2.54	4.92
3P	5.08	7.46
4P	7.62	10.00
5P	10.16	12.54
6P	12.70	15.08
7P	15.24	17.62
8P	17.78	20.16
9P	20.32	22.70
10P	22.86	25.24
11P	25.40	27.78
12P	27.94	30.32
13P	30.48	32.86
14P	33.02	35.40
15P	35.56	37.94
16P	38.10	40.48
17P	40.64	43.02
18P	43.18	45.56
19P	45.72	48.10
20P	48.26	50.64
21P	50.80	53.18
22P	53.34	55.72
23P	55.88	58.26
24P	58.42	60.80
25P	60.96	63.34

Unit: mm

### A2550H-XP-H2

2.54mm Pitch Crimp Flex Housing

**Reference Informations:**

- \*Material:PBT30%GF,UL94V-0
- \*Suitable CJT A2550 series Terminal (A2550-T-J)
- \*Mates with CJT A2547 series Wafer
- \*Color:Black

**Ordering Information:**

- A2550H-XP-H2 - \*\*\*  
 1 2  
 1.Part No.  
 2.Material:  
 (blank):PBT30%GF,UL94V-0  
 GWT:PBT,UL94V-0,GWT 750°C

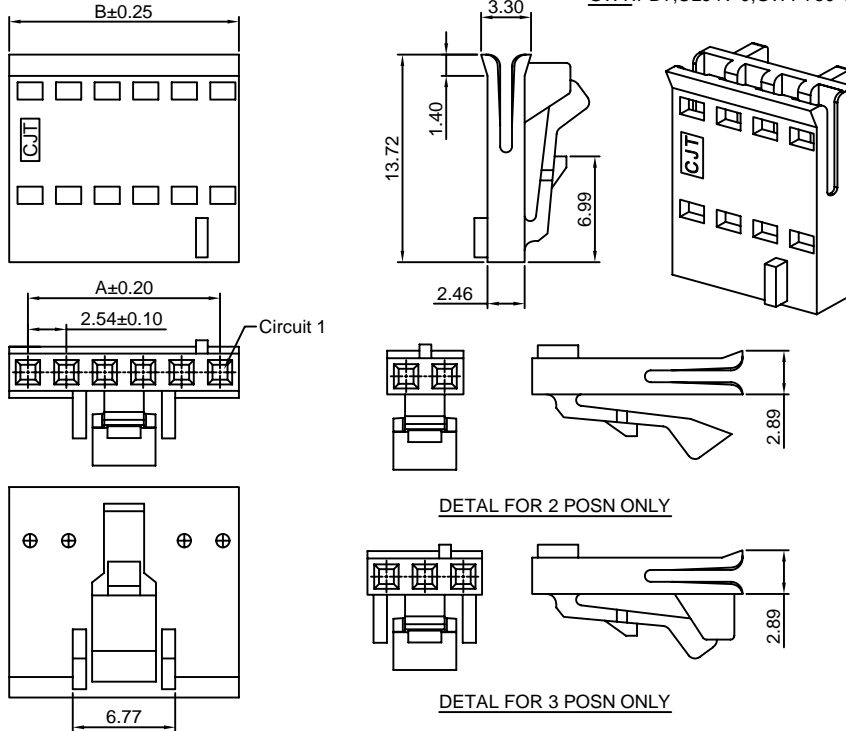

**Ordering Information & Dimensions:**

PART NO.	Dimensions	
	A	B
2P	2.54	4.92
3P	5.08	7.46
4P	7.62	10.00
5P	10.16	12.54
6P	12.70	15.08
7P	15.24	17.62
8P	17.78	20.16
9P	20.32	22.70
10P	22.86	25.24
11P	25.40	27.78
12P	27.94	30.32
13P	30.48	32.86
14P	33.02	35.40
15P	35.56	37.94
16P	38.10	40.48
17P	40.64	43.02
18P	43.18	45.56
19P	45.72	48.10
20P	48.26	50.64
21P	50.80	53.18
22P	53.34	55.72
23P	55.88	58.26
24P	58.42	60.80
25P	60.96	63.34

Unit: mm

### A2550H-XP-I

2.54mm Pitch Crimp Flex Housing

**Reference Informations:**

- \*Material:PBT30%GF,UL94V-0
- \*Suitable CJT A2550 series Terminal (A2550-T-J)
- \*Mates with CJT A2549 series Wafer or A2547WVE,WRE-XP series Wafer
- \*Color:Black

**Ordering Information:**

- A2550H-XP-I - \*\*\*  
 1 2  
 1.Part No.  
 2.Material:  
 (blank):PBT30%GF,UL94V-0  
 GWT:PBT,UL94V-0,GWT 750°C

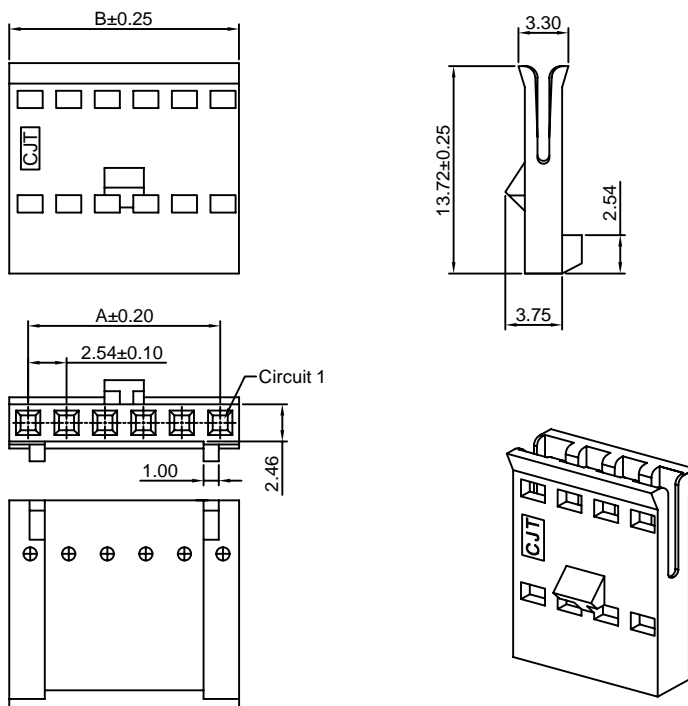

**Ordering Information & Dimensions:**

PART NO.	Dimensions	
	A	B
2P	2.54	4.92
3P	5.08	7.46
4P	7.62	10.00
5P	10.16	12.54
6P	12.70	15.08
7P	15.24	17.62
8P	17.78	20.16
9P	20.32	22.70
10P	22.86	25.24
11P	25.40	27.78
12P	27.94	30.32
13P	30.48	32.86
14P	33.02	35.40
15P	35.56	37.94
16P	38.10	40.48
17P	40.64	43.02
18P	43.18	45.56
19P	45.72	48.10
20P	48.26	50.64
21P	50.80	53.18
22P	53.34	55.72
23P	55.88	58.26
24P	58.42	60.80
25P	60.96	63.34

Unit: mm



### A2550H-XP-I1

2.54mm Pitch Crimp Flex Housing

**Reference Informations:**

- \*Material: PBT30%GF, UL94V-0
- \*Suitable CJT A2550 series Terminal (A2550-T-J)
- \*Mates with CJT A2549 series Wafer or A2547WVE, WRE-XP series Wafer
- \*Color: Black

**Ordering Information:**

- A2550H-XP-I1 - \*\*\*  
 $\frac{1}{2}$
1. Part No.
  2. Material:  
 (blank): PBT30%GF, UL94V-0  
 GWT: PBT, UL94V-0, GWT 750°C

**Ordering Information & Dimensions:**

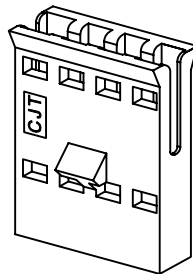
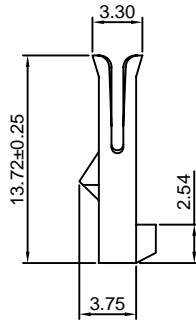
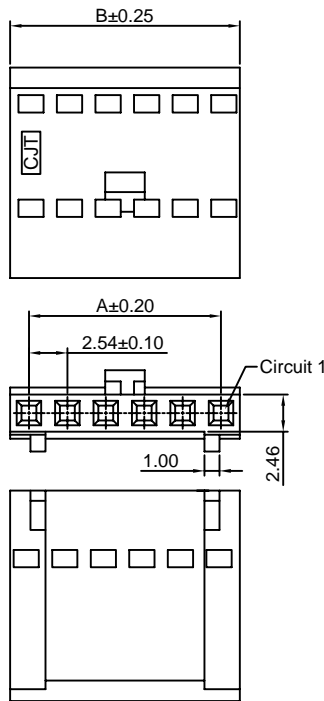

PART NO.	Dimensions	
	A	B
2P	2.54	4.92
3P	5.08	7.46
4P	7.62	10.00
5P	10.16	12.54
6P	12.70	15.08
7P	15.24	17.62
8P	17.78	20.16
9P	20.32	22.70
10P	22.86	25.24
11P	25.40	27.78
12P	27.94	30.32
13P	30.48	32.86
14P	33.02	35.40
15P	35.56	37.94
16P	38.10	40.48
17P	40.64	43.02
18P	43.18	45.56
19P	45.72	48.10
20P	48.26	50.64
21P	50.80	53.18
22P	53.34	55.72
23P	55.88	58.26
24P	58.42	60.80
25P	60.96	63.34

Unit: mm

### A2550H-XP-J

2.54mm Pitch Crimp Flex Housing

**Reference Informations:**

- \*Material: PBT30%GF, UL94V-0
- \*Suitable CJT A2550 series Terminal (A2550-T(-H), A2550-T(-H)-CR, A2550-T-A, A2550-T-C, A2550M-T)
- \*Mates with CJT A2541 series Wafer
- \*Color: Black

**Ordering Information:**

- A2550H-XP-J - \*\*\*  
 $\frac{1}{2}$
1. Part No.
  2. Material:  
 (blank): PBT30%GF, UL94V-0  
 GWT: PBT, UL94V-0, GWT 750°C

**Ordering Information & Dimensions:**

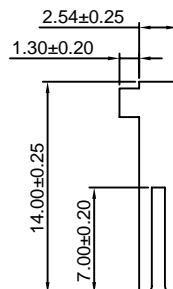
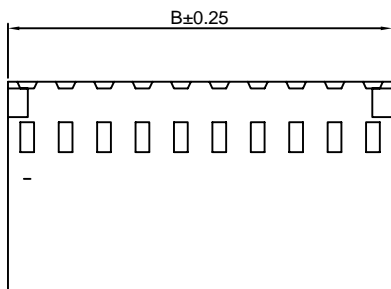
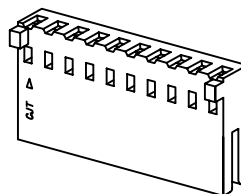
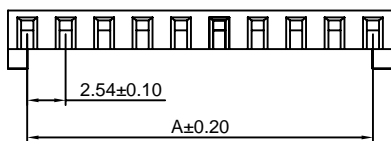

PART NO.	Dimensions	
	A	B
2P	2.54	5.08
3P	5.08	7.62
4P	7.62	10.16
5P	10.16	12.70
6P	12.70	15.24
7P	15.24	17.78
8P	17.78	20.32
9P	20.32	22.86
10P	22.86	25.40
11P	25.40	27.94
12P	27.94	30.48
13P	30.48	33.02
14P	33.02	35.56
15P	35.56	38.10
16P	38.10	40.64
17P	40.64	43.18
18P	43.18	45.72
19P	45.72	48.26
20P	48.26	50.80
21P	50.80	53.34
22P	53.34	55.88
23P	55.88	58.42
24P	58.42	60.96
25P	60.96	63.50

Unit: mm

### A2550HD-XP

2.54mm Pitch Crimp Flex Housing

**Reference Informations:**

- \*Material:Nylon 66,UL94V-0
- \*Terminal Material:Phosphor Bronze/Tin over Nickel
- \*Mates with CJT A2541 series Wafer
- \*Used in FFC Wire
- \*Color:Blue

**Ordering Information:**

- A2550HD-XP - \*\*\* - \*  
 1 2 3
- 1.Part No.
  - 2.Material:  
 (blank):Nylon 66,UL94V-0  
 GWT:Nylon 66,UL94V-0,GWT 750°C
  - 3.Finish:  
 (blank):Tin over Nickel  
 G:Gold over Nickel

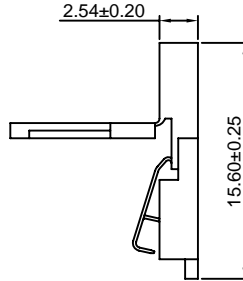
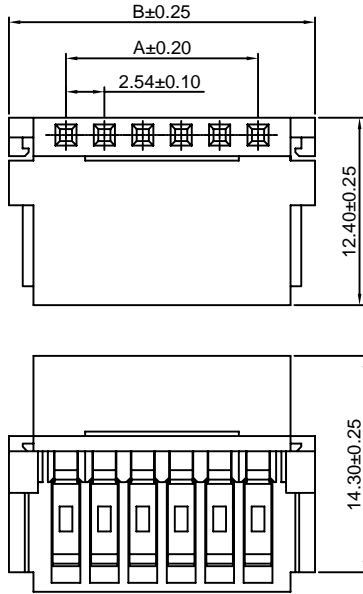
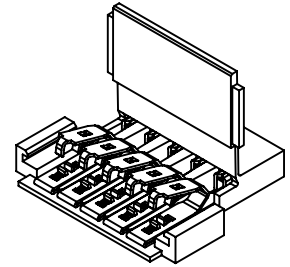

**Ordering Information & Dimensions:**

PART NO.	Dimensions		PART NO.	Dimensions	
	A	B		A	B
2P	2.54	10.08	20P	48.26	55.80
3P	5.08	12.62	21P	50.80	58.34
4P	7.62	15.16	22P	53.34	60.88
5P	10.16	17.70	23P	55.88	63.42
6P	12.70	20.24	24P	58.42	65.96
7P	15.24	22.78	25P	60.96	68.50
8P	17.78	25.32	26P	63.50	71.04
9P	20.32	27.86	27P	66.04	73.58
10P	22.86	30.40	28P	68.58	76.12
11P	25.40	32.94	29P	71.12	78.66
12P	27.94	35.48	30P	73.66	81.20
13P	30.48	38.02	31P	76.20	83.74
14P	33.02	40.56	32P	78.74	86.28
15P	35.56	43.10	33P	81.28	88.82
16P	38.10	45.64	34P	83.82	91.36
17P	40.64	48.18	35P	86.36	93.90
18P	43.18	50.72	36P	88.90	96.44
19P	45.72	53.26			

Unit: mm

### A2550HDM-XP

2.54mm Pitch Crimp Flex Housing

**Reference Informations:**

- \*Material:Nylon 66,UL94V-0
- \*Terminal Material:Phosphor Bronze/Tin over Nickel
- \*Used in FFC Wire
- \*Color:Blue

**Ordering Information:**

- A2550HDM-XP - \*\*\* - \*  
 1 2 3
- 1.Part No.
  - 2.Material:  
 (blank):Nylon 66,UL94V-0  
 GWT:Nylon 66,UL94V-0,GWT 750°C
  - 3.Finish:  
 (blank):Tin over Nickel  
 G:Gold over Nickel

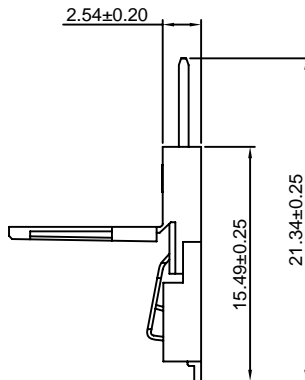
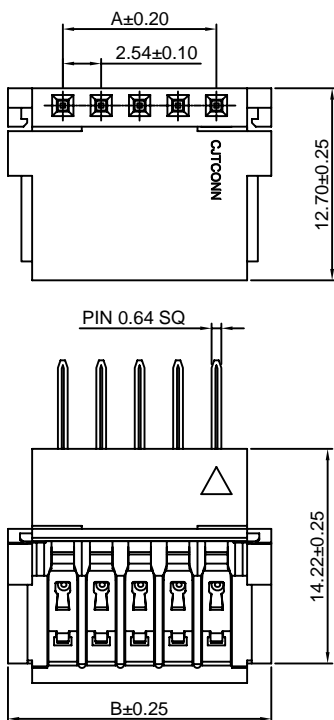

**Ordering Information & Dimensions:**

PART NO.	Dimensions		PART NO.	Dimensions	
	A	B		A	B
2P	2.54	9.91	20P	48.26	55.63
3P	5.08	12.45	21P	50.80	58.17
4P	7.62	14.99	22P	53.34	60.71
5P	10.16	17.53	23P	55.88	63.25
6P	12.70	20.07	24P	58.42	65.79
7P	15.24	22.61	25P	60.96	68.33
8P	17.78	25.15	26P	63.50	70.87
9P	20.32	27.69	27P	66.04	73.41
10P	22.86	30.23	28P	68.58	75.95
11P	25.40	32.77	29P	71.12	78.49
12P	27.94	35.31	30P	73.66	81.03
13P	30.48	37.85	31P	76.20	83.57
14P	33.02	40.39	32P	78.74	86.11
15P	35.56	42.93	33P	81.28	88.65
16P	38.10	45.47	34P	83.82	91.19
17P	40.64	48.01	35P	86.36	93.73
18P	43.18	50.55	36P	88.90	96.27
19P	45.72	53.09			

Unit: mm

### A2550HE-XP

2.54mm Pitch Crimp Flex Housing

**Reference Informations:**

- \*Material: Nylon 66, UL94V-0
- \*Terminal Material: Phosphor Bronze/Tin over Nickel
- \*Mates with CJT A2541WV, WR-XP, A2549WVB, WRB-XP series Wafer
- \*Used in FFC Wire
- \*Color: Blue

**Ordering Information:**

A2550HE-XP - \*\*\* - \*  
 1 2 3

1. Part No.
2. Material:  
 (blank): Nylon 66, UL94V-0  
 GWT: Nylon 66, UL94V-0, GWT 750°C
3. Finish:  
 (blank): Tin over Nickel  
 G: Gold over Nickel

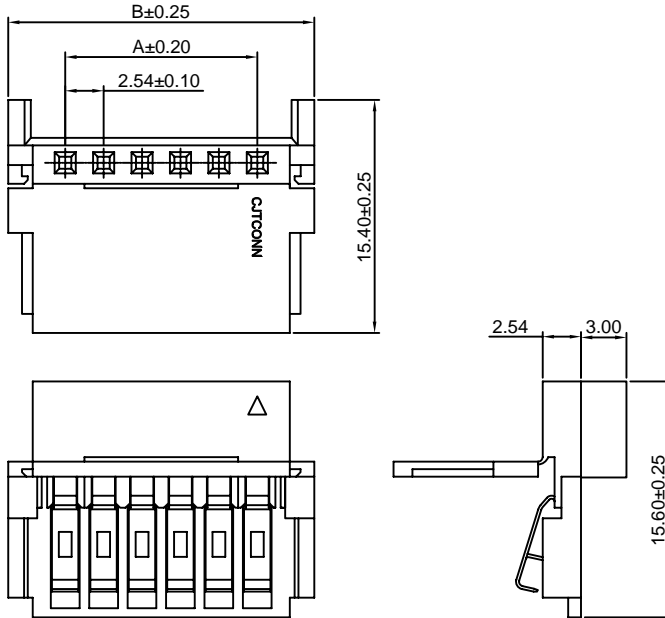

**Ordering Information & Dimensions:**

PART NO.	Dimensions		PART NO.	Dimensions	
	A	B		A	B
2P	2.54	10.08	19P	45.72	53.26
3P	5.08	12.62	20P	48.26	55.80
4P	7.62	15.16	21P	50.80	58.34
5P	10.16	17.70	22P	53.34	60.88
6P	12.70	20.24	23P	55.88	63.42
7P	15.24	22.78	24P	58.42	65.96
8P	17.78	25.32	25P	60.96	68.50
9P	20.32	27.86	26P	63.50	71.04
10P	22.86	30.40	27P	66.04	73.58
11P	25.40	32.94	28P	68.58	76.12
12P	27.94	35.48	29P	71.12	78.66
13P	30.48	38.02	30P	73.66	81.20
14P	33.02	40.56	31P	76.20	83.74
15P	35.56	43.10	32P	78.74	86.28
16P	38.10	45.64	33P	81.28	88.82
17P	40.64	48.18	34P	83.82	91.36
18P	43.18	50.72			

Unit: mm

### A2550HF-XP

2.54mm Pitch Crimp Flex Housing

**Reference Informations:**

- \*Material: Nylon 66, UL94V-0
- \*Terminal Material: Phosphor Bronze/Tin over Nickel
- \*Mates with CJT A2547HM-XP, A2550HM-XP series Housing or A2547WVA, WRA-XP series Wafer
- \*Used in FFC Wire
- \*Color: Blue

**Ordering Information:**

A2550HF-XP - \*\*\* - \*  
 1 2 3

1. Part No.
2. Material:  
 (blank): Nylon 66, UL94V-0  
 GWT: Nylon 66, UL94V-0, GWT 750°C
3. Finish:  
 (blank): Tin over Nickel  
 G: Gold over Nickel

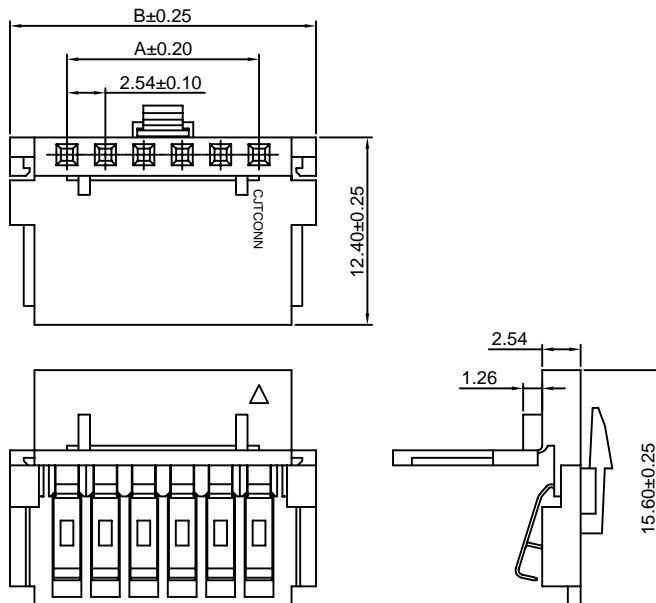

**Ordering Information & Dimensions:**

PART NO.	Dimensions		PART NO.	Dimensions	
	A	B		A	B
6P	12.70	20.24	21P	50.80	58.34
7P	15.24	22.78	22P	53.34	60.88
8P	17.78	25.32	23P	55.88	63.42
9P	20.32	27.86	24P	58.42	65.96
10P	22.86	30.40	25P	60.96	68.50
11P	25.40	32.94	26P	63.50	71.04
12P	27.94	35.48	27P	66.04	73.58
13P	30.48	38.02	28P	68.58	76.12
14P	33.02	40.56	29P	71.12	78.66
15P	35.56	43.10	30P	73.66	81.20
16P	38.10	45.64	31P	76.20	83.74
17P	40.64	48.18	32P	78.74	86.28
18P	43.18	50.72	33P	81.28	88.82
19P	45.72	53.26	34P	83.82	91.36
20P	48.26	55.80			

Unit: mm

### A2550HG-XP

2.54mm Pitch Crimp Flex Housing

**Reference Informations:**

- \*Material: Nylon 66, UL94V-0
- \*Terminal Material: Phosphor Bronze/Tin over Nickel
- \*Mates with CJT A2547HM-XP, A2550HM, HMA-XP series Housing or A2547WVA, WRA-XP series Wafer
- \*Used in FFC Wire
- \*Color: Blue

**Ordering Information:**

A2550HG-XP - \*\*\* - \*  
 1                    2    3

1. Part No.
2. Material:  
 (blank): Nylon 66, UL94V-0  
 GWT: Nylon 66, UL94V-0, GWT 750 °C
3. Finish:  
 (blank): Tin over Nickel  
 G: Gold over Nickel

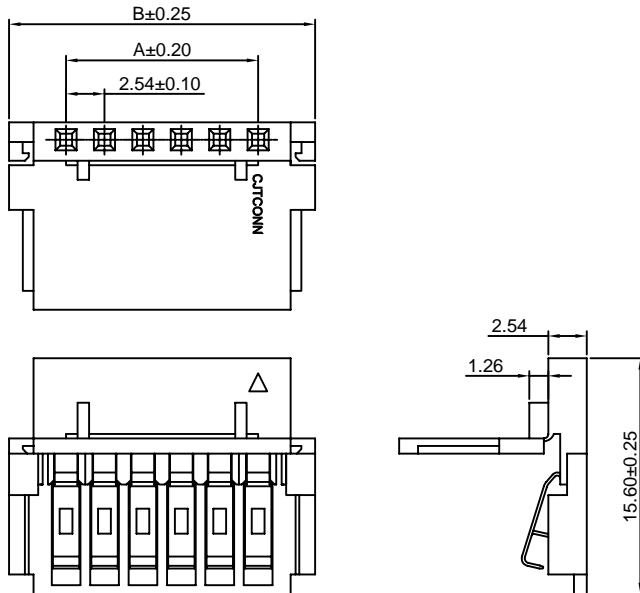

**Ordering Information & Dimensions:**

PART NO.	Dimensions		PART NO.	Dimensions	
	A	B		A	B
6P	12.70	20.24	21P	50.80	58.34
7P	15.24	22.78	22P	53.34	60.88
8P	17.78	25.32	23P	55.88	63.42
9P	20.32	27.86	24P	58.42	65.96
10P	22.86	30.40	25P	60.96	68.50
11P	25.40	32.94	26P	63.50	71.04
12P	27.94	35.48	27P	66.04	73.58
13P	30.48	38.02	28P	68.58	76.12
14P	33.02	40.56	29P	71.12	78.66
15P	35.56	43.10	30P	73.66	81.20
16P	38.10	45.64	31P	76.20	83.74
17P	40.64	48.18	32P	78.74	86.28
18P	43.18	50.72	33P	81.28	88.82
19P	45.72	53.26	34P	83.82	91.36
20P	48.26	55.80			

Unit: mm

### A2550HK-XP

2.54mm Pitch Crimp Flex Housing

**Reference Informations:**

- \*Material: PBT30%GF, UL94V-0
- \*Suitable CJT A2550 series Terminal (A2550-T-K)
- \*Color: Blue

**Ordering Information:**

A2550HK-XP - \*\*\*  
 1                    2

1. Part No.
2. Material:  
 (blank): PBT30%GF, UL94V-0  
 GWT: PBT, UL94V-0, GWT 750 °C

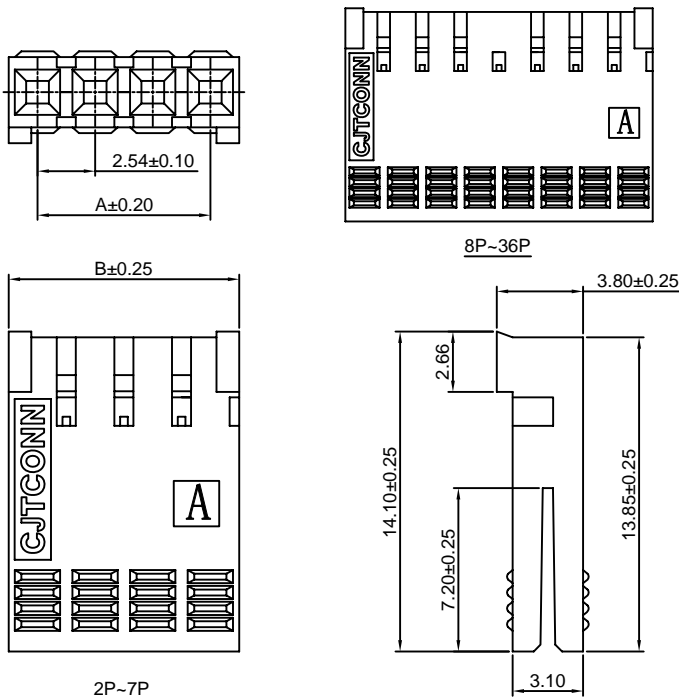
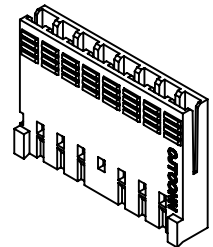

**Ordering Information & Dimensions:**

PART NO.	Dimensions		PART NO.	Dimensions	
	A	B		A	B
2P	2.54	5.08	20P	48.26	50.80
3P	5.08	7.62	21P	50.80	53.34
4P	7.62	10.16	22P	53.34	55.88
5P	10.16	12.70	23P	55.88	58.42
6P	12.70	15.24	24P	58.42	60.96
7P	15.24	17.78	25P	60.96	63.50
8P	17.78	20.32	26P	63.50	66.04
9P	20.32	22.86	27P	66.04	68.58
10P	22.86	25.40	28P	68.58	71.12
11P	25.40	27.94	29P	71.12	73.66
12P	27.94	30.48	30P	73.66	76.20
13P	30.48	33.02	31P	76.20	78.74
14P	33.02	35.56	32P	78.74	81.28
15P	35.56	38.10	33P	81.28	83.82
16P	38.10	40.64	34P	83.82	86.36
17P	40.64	43.18	35P	86.36	88.90
18P	43.18	45.72	36P	88.90	91.44
19P	45.72	48.26			

Unit: mm

### A2550HL-XP

2.54mm Pitch Crimp Flex Housing

**Reference Informations:**

- \*Material:PBT30%GF,UL94V-0
- \*Suitable CJT A2550 series Terminal (A2550-T(-H), A2550-T(-H)-CR, A2550-T-A, A2550-T-C, A2550M-T)
- \*Mates with CJT A2541 series Wafer
- \*Color:Black

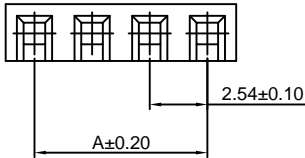
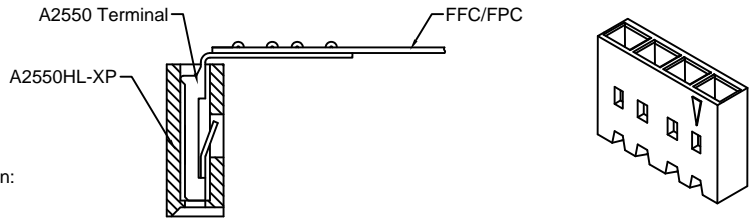

**Ordering Information:**

- A2550HL-XP - \*\*\*  
 1 Part No.  
 2 Material:  
 (blank):PBT30%GF,UL94V-0  
 GWT:PBT,UL94V-0,GWT 750°C

**Ordering Information & Dimensions:**

PART NO.	Dimensions		PART NO.	Dimensions	
	A	B		A	B
2P	2.54	5.08	20P	48.26	50.80
3P	5.08	7.62	21P	50.80	53.34
4P	7.62	10.16	22P	53.34	55.88
5P	10.16	12.70	23P	55.88	58.42
6P	12.70	15.24	24P	58.42	60.96
7P	15.24	17.78	25P	60.96	63.50
8P	17.78	20.32	26P	63.50	66.04
9P	20.32	22.86	27P	66.04	68.58
10P	22.86	25.40	28P	68.58	71.12
11P	25.40	27.94	29P	71.12	73.66
12P	27.94	30.48	30P	73.66	76.20
13P	30.48	33.02	31P	76.20	78.74
14P	33.02	35.56	32P	78.74	81.28
15P	35.56	38.10	33P	81.28	83.82
16P	38.10	40.64	34P	83.82	86.36
17P	40.64	43.18	35P	86.36	88.90
18P	43.18	45.72	36P	88.90	91.44
19P	45.72	48.26			

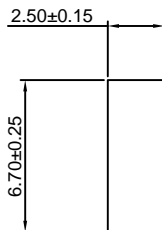
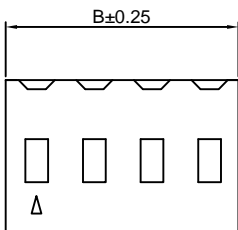

Unit: mm

### A2550H-XP-M

2.54mm Pitch Housing With Lock

**Reference Informations:**

- \*Material:PBT30%GF, UL94V-0
- \*Suitable CJT A2550-T-E series Terminal
- \*Mates with CJT A2547HM-XP A2550HM-XP series Housing or A2547 series single row Wafer
- \*Color:Black

**Ordering Information:**

- A2550H-XP-M - \*\*\*  
 1 Part No.  
 2 Material:  
 (blank):PBT30%GF,UL94V-0  
 GWT:PBT,UL94V-0,GWT 750°C

**Ordering Information & Dimensions:**

PART NO.	Dimensions	
	A	B
2P	2.54	5.08
3P	5.08	7.62
4P	7.62	10.16
5P	10.16	12.70
6P	12.70	15.24
7P	15.24	17.78
8P	17.78	20.32
9P	20.32	22.86
10P	22.86	25.40
11P	25.40	27.94
12P	27.94	30.48
13P	30.48	33.02
14P	33.02	35.56
15P	35.56	38.10
16P	38.10	40.64
17P	40.64	43.18
18P	43.18	45.72
19P	45.72	48.26
20P	48.26	50.80
21P	50.80	53.34
22P	53.34	55.88
23P	55.88	58.42
24P	58.42	60.96
25P	60.96	63.50

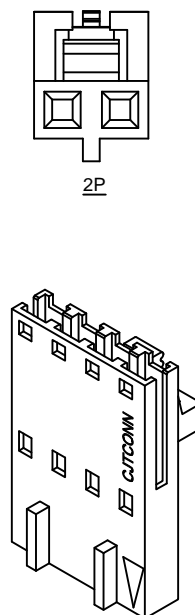
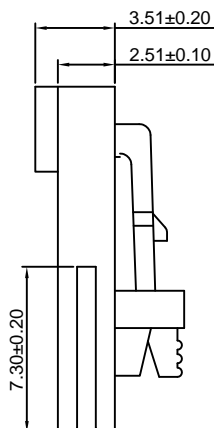
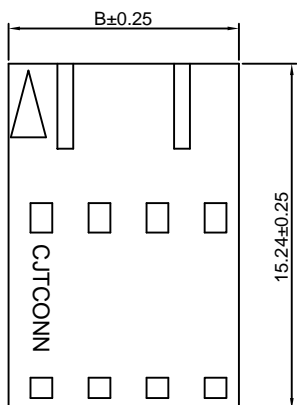
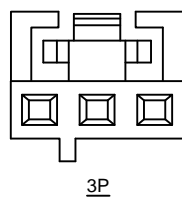
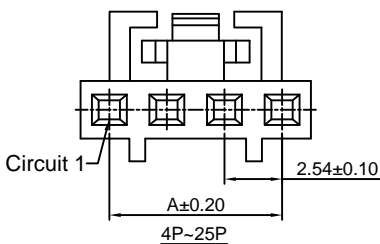

Unit: mm

### A2550H-XP-M1

2.54mm Pitch Housing

**Reference Informations:**

- \*Material:PBT30%GF , UL94V-0
- \*Suitable CJT A2550-T-E, A2550M-T-D series Terminal
- \*Mates with CJT A2547WV,WR-XP, A2547WVA,WRA-XP series single row Wafer
- \*Color:Black

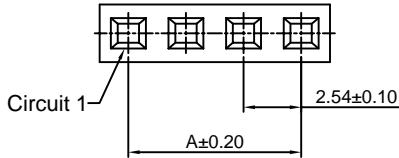

Ordering Information:  
A2550H-XP-M1 - \*\*\*  
 $\frac{1}{2}$

1.Part No.  
 2.Material:  
 (blank):PBT30%GF,UL94V-0  
 GWT:PBT,UL94V-0,GWT 750°C

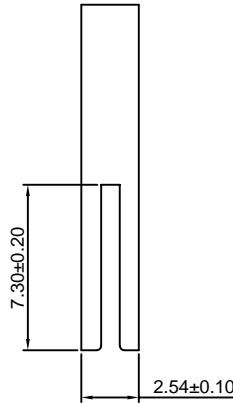
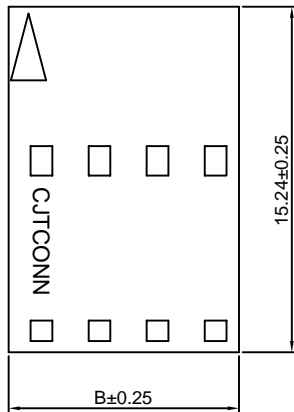
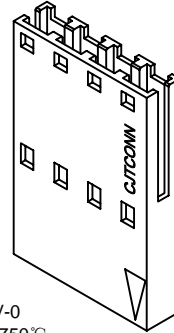

**Ordering Information & Dimensions:**

PART NO.	Dimensions	
	A	B
2P	2.54	5.08
3P	5.08	7.62
4P	7.62	10.16
5P	10.16	12.70
6P	12.70	15.24
7P	15.24	17.78
8P	17.78	20.32
9P	20.32	22.86
10P	22.86	25.40
11P	25.40	27.94
12P	27.94	30.48
13P	30.48	33.02
14P	33.02	35.56
15P	35.56	38.10
16P	38.10	40.64
17P	40.64	43.18
18P	43.18	45.72
19P	45.72	48.26
20P	48.26	50.80
21P	50.80	53.34
22P	53.34	55.88
23P	55.88	58.42
24P	58.42	60.96
25P	60.96	63.50

Unit: mm

### A2550H-XP-M2

2.54mm Pitch Housing

**Reference Informations:**

- \*Material:PBT30%GF , UL94V-0
- \*Suitable CJT A2550-T-E series Terminal
- \*Mates with CJT A2547WV,WR-XP, A2547WVA,WRA-XP series single row Wafer
- \*Color:Black

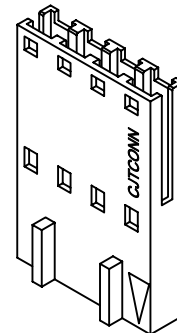
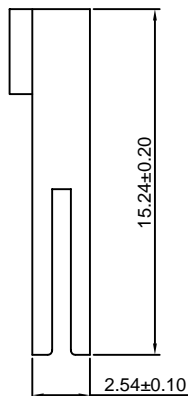
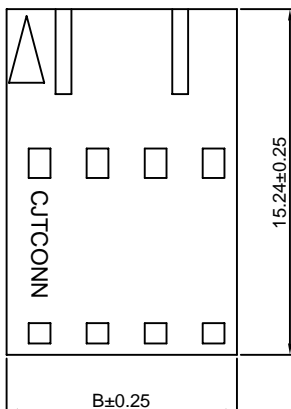
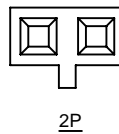
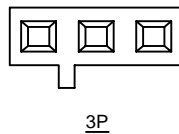
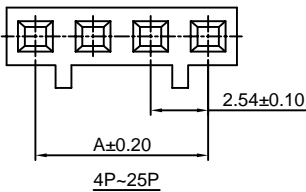

Ordering Information:  
A2550H-XP-M2 - \*\*\*  
 $\frac{1}{2}$

1.Part No.  
 2.Material:  
 (blank):PBT30%GF,UL94V-0  
 GWT:PBT,UL94V-0,GWT 750°C

**Ordering Information & Dimensions:**

PART NO.	Dimensions	
	A	B
2P	2.54	5.08
3P	5.08	7.62
4P	7.62	10.16
5P	10.16	12.70
6P	12.70	15.24
7P	15.24	17.78
8P	17.78	20.32
9P	20.32	22.86
10P	22.86	25.40
11P	25.40	27.94
12P	27.94	30.48
13P	30.48	33.02
14P	33.02	35.56
15P	35.56	38.10
16P	38.10	40.64
17P	40.64	43.18
18P	43.18	45.72
19P	45.72	48.26
20P	48.26	50.80
21P	50.80	53.34
22P	53.34	55.88
23P	55.88	58.42
24P	58.42	60.96
25P	60.96	63.50

Unit: mm

### A2550H-XP-M3

2.54mm Pitch Housing

**Reference Informations:**

- \*Material:PBT30%GF , UL94V-0
- \*Suitable CJT A2550-T-E,A2550M-T-D series Terminal
- \*Color:Black

**Ordering Information:**

A2550H-XP-M3 - \*\*\*  
 $\frac{1}{2}$   
 1.Part No.  
 2.Material:  
 (blank):PBT30%GF,UL94V-0  
GWT:PBT,UL94V-0,GWT 750°C

**Ordering Information & Dimensions:**

PART NO.	Dimensions	
	A	B
2P	2.54	5.08
3P	5.08	7.62
4P	7.62	10.16
5P	10.16	12.70
6P	12.70	15.24
7P	15.24	17.78
8P	17.78	20.32
9P	20.32	22.86
10P	22.86	25.40
11P	25.40	27.94
12P	27.94	30.48
13P	30.48	33.02
14P	33.02	35.56
15P	35.56	38.10
16P	38.10	40.64
17P	40.64	43.18
18P	43.18	45.72
19P	45.72	48.26
20P	48.26	50.80
21P	50.80	53.34
22P	53.34	55.88
23P	55.88	58.42
24P	58.42	60.96
25P	60.96	63.50

Unit: mm

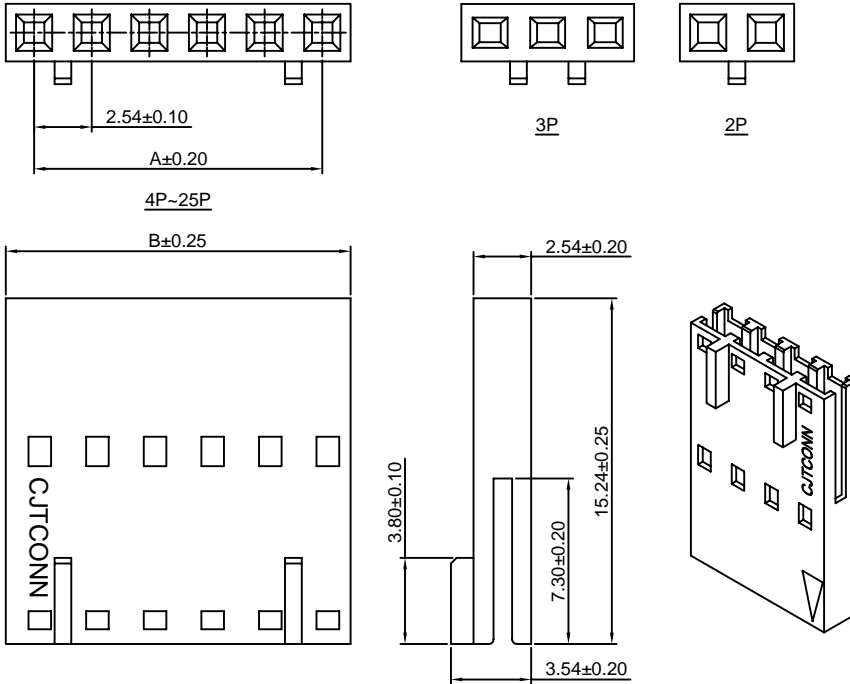

### A2550H-XP-MH

2.54mm Pitch Housing With Lock

**Reference Informations:**

- \*Material:PBT30%GF , UL94V-0
- \*Suitable CJT A2550-T-E series Terminal
- \*Mates with CJT A2547HM-XP A2550HM-XP series Housing or A2547 series single row Wafer
- \*Color:Black

**Ordering Information:**

A2550H-XP-MH - \*\*\*  
 $\frac{1}{2}$   
 1.Part No.  
 2.Material:  
 (blank):PBT30%GF,UL94V-0  
GWT:PBT,UL94V-0,GWT 750°C

**Ordering Information & Dimensions:**

PART NO.	Dimensions	
	A	B
2P	2.54	5.08
3P	5.08	7.62
4P	7.62	10.16
5P	10.16	12.70
6P	12.70	15.24
7P	15.24	17.78
8P	17.78	20.32
9P	20.32	22.86
10P	22.86	25.40
11P	25.40	27.94
12P	27.94	30.48
13P	30.48	33.02
14P	33.02	35.56
15P	35.56	38.10
16P	38.10	40.64
17P	40.64	43.18
18P	43.18	45.72
19P	45.72	48.26
20P	48.26	50.80
21P	50.80	53.34
22P	53.34	55.88
23P	55.88	58.42
24P	58.42	60.96
25P	60.96	63.50

Unit: mm

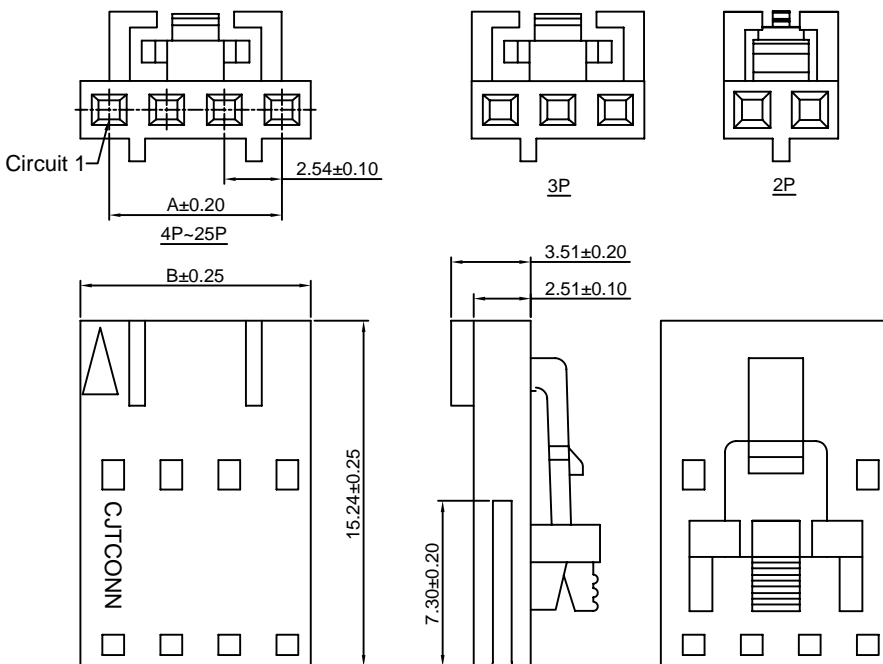

## A2550HH-N-XP

2.54mm Pitch Crimp Flex Housing

### Reference Informations:

- \*Material: PBT30%GF, UL94V-0
- \*Suitable CJT A2550 series Terminal (A2550-T(-H), A2550-T(-H)-CR, A2550-T-A, A2550-T-C, A2550M-T)
- \*Mates with CJT A2541 series Wafer
- \*Color: Black

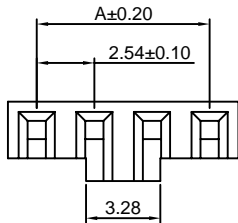

Ordering Information:  
A2550HH-N-XP - \*\*\*  
1 2

- 1. Part No.
- 2. Material:  
(blank): PBT30%GF, UL94V-0  
GWT: PBT, UL94V-0, GWT 750°C

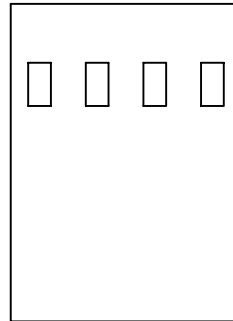
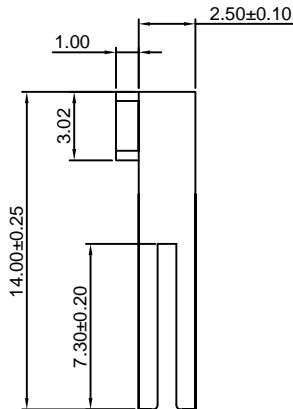
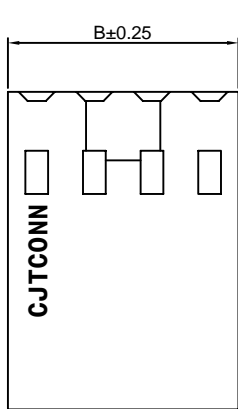

### Ordering Information & Dimensions:

PART NO.	Dimensions	
	A	B
2P	2.54	5.08
3P	5.08	7.62
4P	7.62	10.16
5P	10.16	12.70
6P	12.70	15.24
7P	15.24	17.78
8P	17.78	20.32
9P	20.32	22.86
10P	22.86	25.40
11P	25.40	27.94
12P	27.94	30.48
13P	30.48	33.02
14P	33.02	35.56
15P	35.56	38.10
16P	38.10	40.64
17P	40.64	43.18
18P	43.18	45.72
19P	45.72	48.26
20P	48.26	50.80
21P	50.80	53.34
22P	53.34	55.88
23P	55.88	58.42
24P	58.42	60.96
25P	60.96	63.50

Unit: mm

## A2550HM-XP

2.54mm Pitch Crimp Flex Housing

### Reference Informations:

- \*Material: PBT30%GF, UL94V-0
- \*Suitable CJT A2550M-T-D series Terminal
- \*Mates with CJT A2550 series Housing (A2550H-XP-A, A2550H-XP-A1, A2550H-XP-A2, A2550H-XP-H, A2547H, HA-XP)
- \*Color: Black

Ordering Information:  
A2550HM-XP - \*\*\*  
1 2

- 1. Part No.
- 2. Material:  
(blank): PBT30%GF, UL94V-0  
GWT: PBT, UL94V-0, GWT 750°C

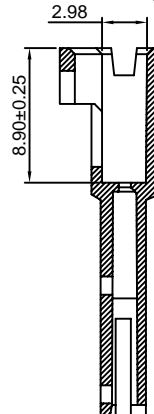
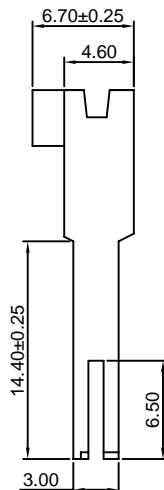
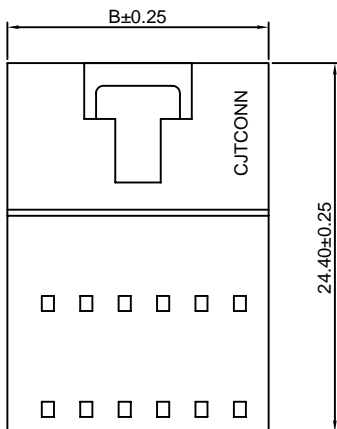
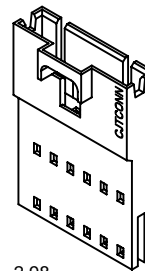
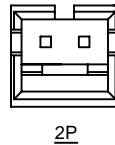
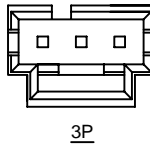
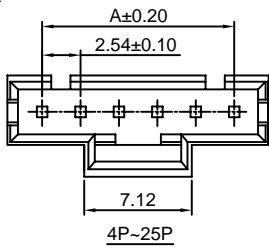

### Ordering Information & Dimensions:

PART NO.	Dimensions	
	A	B
2P	2.54	7.12
3P	5.08	9.66
4P	7.62	12.20
5P	10.16	14.74
6P	12.70	17.28
7P	15.24	19.82
8P	17.78	22.36
9P	20.32	24.90
10P	22.86	27.44
11P	25.40	29.98
12P	27.94	32.52
13P	30.48	35.06
14P	33.02	37.60
15P	35.56	40.14
16P	38.10	42.68
17P	40.64	45.22
18P	43.18	47.76
19P	45.72	50.30
20P	48.26	52.84
21P	50.80	55.38
22P	53.34	57.92
23P	55.88	60.46
24P	58.42	63.00
25P	60.96	65.54

Unit: mm



### A2550HMA-XP

2.54mm Pitch Crimp Flex Housing

**Reference Informations:**

- \*Material: PBT30%GF, UL94V-0
- \*Suitable CJT A2550M-T-D series Terminal
- \*Mates with CJT A2550H-XP-B, A2547H-XP-3 series Housing
- \*Color: Black

**Ordering Information:**

- A2550HMA-XP - \*\*\*  
 1 2
1. Part No.
  2. Material:  
 (blank): PBT30%GF, UL94V-0  
 GWT: PBT, UL94V-0, GWT 750°C

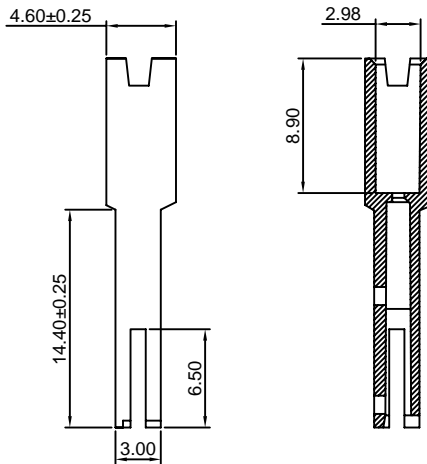
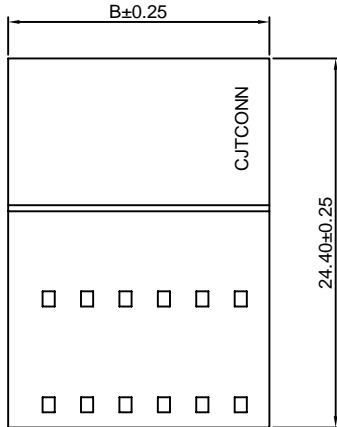
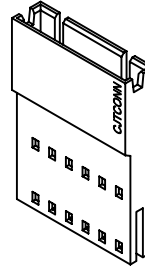
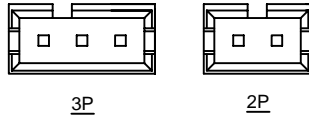
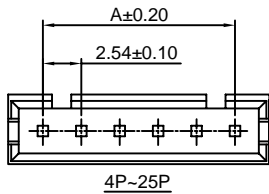

**Ordering Information & Dimensions:**

PART NO.	Dimensions	
	A	B
2P	2.54	7.12
3P	5.08	9.66
4P	7.62	12.20
5P	10.16	14.74
6P	12.70	17.28
7P	15.24	19.82
8P	17.78	22.36
9P	20.32	24.90
10P	22.86	27.44
11P	25.40	29.98
12P	27.94	32.52
13P	30.48	35.06
14P	33.02	37.60
15P	35.56	40.14
16P	38.10	42.68
17P	40.64	45.22
18P	43.18	47.76
19P	45.72	50.30
20P	48.26	52.84
21P	50.80	55.38
22P	53.34	57.92
23P	55.88	60.46
24P	58.42	63.00
25P	60.96	65.54

Unit: mm

### A2550H-2xXP

2.54mm Pitch Crimp Flex Housing

**Reference Informations:**

- \*Material: PBT30%GF, UL94V-0
- \*Suitable CJT A2550 series Terminal (A2550-T(-H), A2550-T(-H)-CR, A2550-T-A, A2550-T-C, A2550M-T)
- \*Mates with CJT A2541 series Wafer
- \*Color: Black

**Ordering Information:**

- A2550H-2xXP - \*\*\*  
 1 2
1. Part No.
  2. Material:  
 (blank): PBT30%GF, UL94V-0  
 GWT: PBT, UL94V-0, GWT 750°C

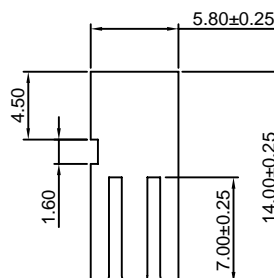
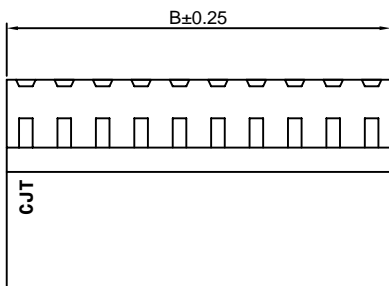
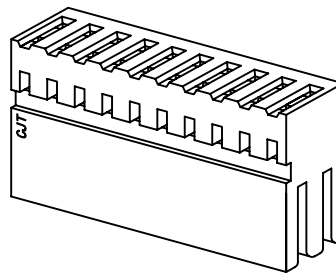
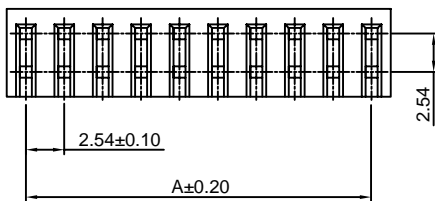

**Ordering Information & Dimensions:**

PART NO.	Dimensions	
	A	B
2x2P	2.54	5.08
2x3P	5.08	7.62
2x4P	7.62	10.16
2x5P	10.16	12.70
2x6P	12.70	15.24
2x7P	15.24	17.78
2x8P	17.78	20.32
2x9P	20.32	22.86
2x10P	22.86	25.40
2x11P	25.40	27.94
2x12P	27.94	30.48
2x13P	30.48	33.02
2x14P	33.02	35.56
2x15P	35.56	38.10
2x16P	38.10	40.64
2x17P	40.64	43.18
2x18P	43.18	45.72
2x19P	45.72	48.26
2x20P	48.26	50.80
2x21P	50.80	53.34
2x22P	53.34	55.88
2x23P	55.88	58.42
2x24P	58.42	60.96
2x25P	60.96	63.50

Unit: mm

### A2550HA-2xXP

2.54mm Pitch Crimp Flex Housing

**Reference Informations:**

- \*Material: PBT30%GF, UL94V-0
- \*Suitable CJT A2550 series Terminal (A2550-T(-H), A2550-T(-H)-CR, A2550-T-A, A2550-T-C)
- \*Mates with CJT A2549WVB, WRB-2xXP series Dual Row Wafer
- \*Color: Black

**Ordering Information:**

- A2550HA-2xXP - \*\*\*  
 1 2  
 1. Part No.  
 2. Material:  
 (blank): PBT30%GF, UL94V-0  
 GWT: PBT, UL94V-0, GWT 750 °C

**Ordering Information & Dimensions:**

PART NO.	Dimensions	
	A	B
2x2P	2.54	5.08
2x3P	5.08	7.62
2x4P	7.62	10.16
2x5P	10.16	12.70
2x6P	12.70	15.24
2x7P	15.24	17.78
2x8P	17.78	20.32
2x9P	20.32	22.86
2x10P	22.86	25.40
2x11P	25.40	27.94
2x12P	27.94	30.48
2x13P	30.48	33.02
2x14P	33.02	35.56
2x15P	35.56	38.10
2x16P	38.10	40.64
2x17P	40.64	43.18
2x18P	43.18	45.72
2x19P	45.72	48.26
2x20P	48.26	50.80
2x21P	50.80	53.34
2x22P	53.34	55.88
2x23P	55.88	58.42
2x24P	58.42	60.96
2x25P	60.96	63.50

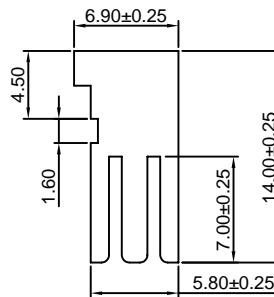
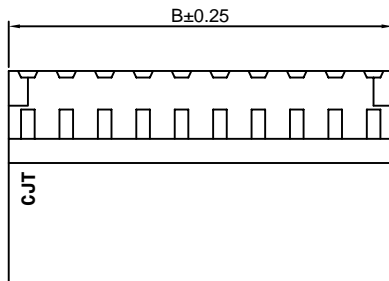
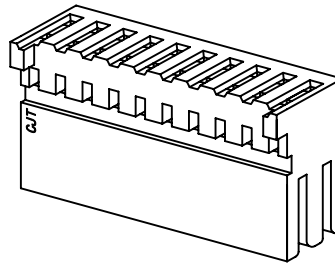
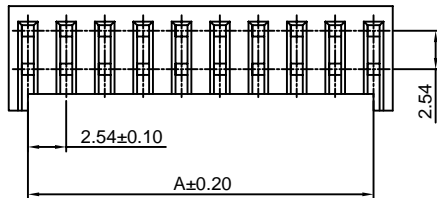

Unit: mm

### A2550H-N-2xXP

2.54mm Pitch Crimp Flex Housing

**Reference Informations:**

- \*Material: PBT30%GF, UL94V-0
- \*Suitable CJT A2550 series Terminal (A2550-T(-H), A2550-T(-H)-CR, A2550-T-A, A2550-T-C, A2550M-T)
- \*Mates with CJT A2541 series Wafer or A2547WV, WR-2xXP series Wafer
- \*Color: Black

**Ordering Information:**

- A2550H-N-2xXP - \*\*\*  
 1 2  
 1. Part No.  
 2. Material:  
 (blank): PBT30%GF, UL94V-0  
 GWT: PBT, UL94V-0, GWT 750 °C

**Ordering Information & Dimensions:**

PART NO.	Dimensions	
	A	B
2x2P	2.54	5.08
2x3P	5.08	7.62
2x4P	7.62	10.16
2x5P	10.16	12.70
2x6P	12.70	15.24
2x7P	15.24	17.78
2x8P	17.78	20.32
2x9P	20.32	22.86
2x10P	22.86	25.40
2x11P	25.40	27.94
2x12P	27.94	30.48
2x13P	30.48	33.02
2x14P	33.02	35.56
2x15P	35.56	38.10
2x16P	38.10	40.64
2x17P	40.64	43.18
2x18P	43.18	45.72
2x19P	45.72	48.26
2x20P	48.26	50.80
2x21P	50.80	53.34
2x22P	53.34	55.88
2x23P	55.88	58.42
2x24P	58.42	60.96
2x25P	60.96	63.50

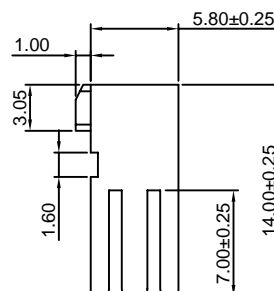
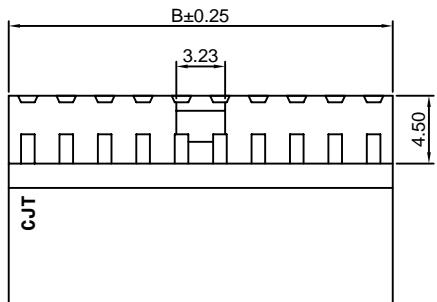
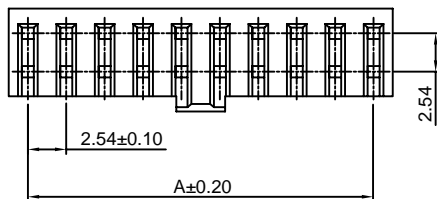

Unit: mm

### A2550HK-2xXP

2.54mm Pitch Crimp Flex Housing

**Reference Informations:**

- \*Material: PBT30%GF, UL94V-0
- \*Suitable CJT A2550 series Terminal (A2550-T-K)
- \*Color: Blue

**Ordering Information:**

A2550HK-2xXP - \*\*\*  
1 2

1. Part No.
2. Material:  
(blank): PBT30%GF, UL94V-0  
GWT: PBT, UL94V-0, GWT 750°C

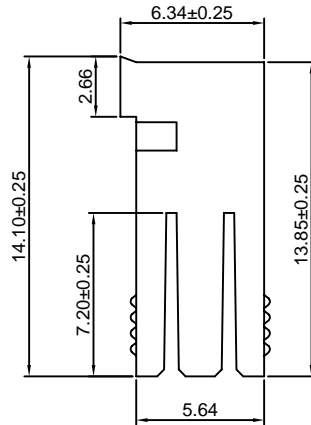
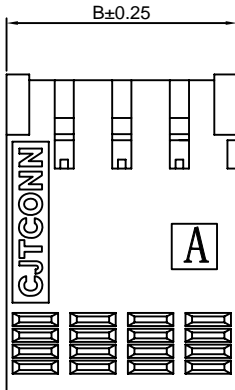
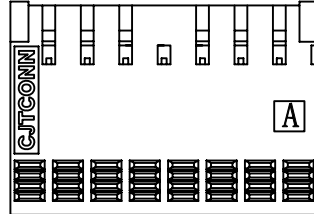
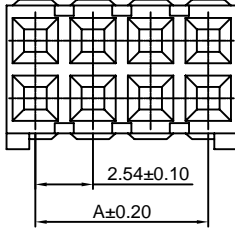
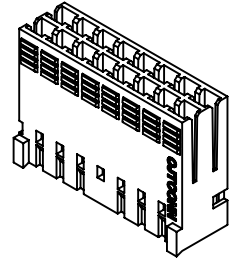

**Ordering Information & Dimensions:**

PART NO.	Dimensions		PART NO.	Dimensions	
	A	B		A	B
2x2P	2.54	5.08	2x20P	48.26	50.80
2x3P	5.08	7.62	2x21P	50.80	53.34
2x4P	7.62	10.16	2x22P	53.34	55.88
2x5P	10.16	12.70	2x23P	55.88	58.42
2x6P	12.70	15.24	2x24P	58.42	60.96
2x7P	15.24	17.78	2x25P	60.96	63.50
2x8P	17.78	20.32	2x26P	63.50	66.04
2x9P	20.32	22.86	2x27P	66.04	68.58
2x10P	22.86	25.40	2x28P	68.58	71.12
2x11P	25.40	27.94	2x29P	71.12	73.66
2x12P	27.94	30.48	2x30P	73.66	76.20
2x13P	30.48	33.02	2x31P	76.20	78.74
2x14P	33.02	35.56	2x32P	78.74	81.28
2x15P	35.56	38.10	2x33P	81.28	83.82
2x16P	38.10	40.64	2x34P	83.82	86.36
2x17P	40.64	43.18	2x35P	86.36	88.90
2x18P	43.18	45.72	2x36P	88.90	91.44
2x19P	45.72	48.26			

Unit: mm

### A2550WVF-XP

2.54mm Pitch Crimp Flex Wafer

**Reference Informations:**

- \*Material: PBT, UL94V-0
- \*Terminal Material: Phosphor Bronze/Tin over Nickel
- \*Color: Black

**Ordering Information:**

A2550WVF-XP - \*\*\*  
1 2

1. Part No.
2. Material:  
(blank): PBT, UL94V-0  
GWT: PBT, UL94V-0, GWT 750°C

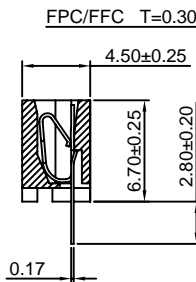
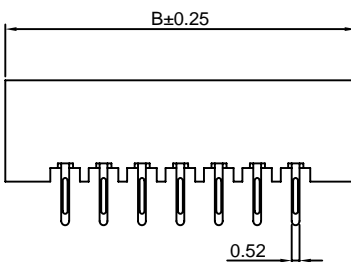
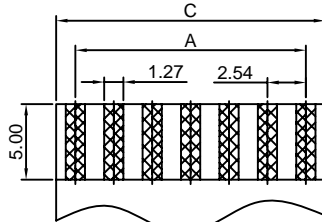
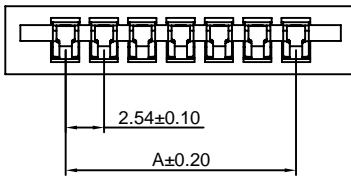
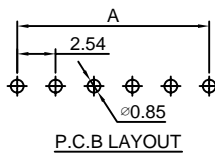
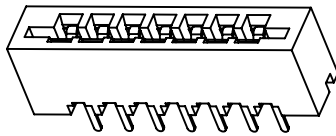

**Ordering Information & Dimensions:**

PART NO.	Dimensions		
	A	B	C
3P	5.08	13.04	10.16
4P	7.62	15.58	12.70
5P	10.16	18.12	15.24
6P	12.70	20.66	17.78
7P	15.24	23.20	20.32
8P	17.78	25.74	22.86
9P	20.32	28.28	25.40
10P	22.86	30.82	27.94
11P	25.40	33.36	30.48
12P	27.94	35.90	33.02
13P	30.48	38.44	35.56
14P	33.02	40.98	38.10
15P	35.56	43.52	40.64
16P	38.10	46.06	43.18
17P	40.64	48.60	45.72
18P	43.18	51.14	48.26
19P	45.72	53.68	50.80
20P	48.26	56.22	53.34
21P	50.80	58.76	55.88
22P	53.34	61.30	58.42
23P	55.88	63.84	60.96
24P	58.42	66.38	63.50
25P	60.96	68.92	66.04

Unit: mm

## A2550WRF-XP

2.54mm Pitch Crimp Flex Wafer

**Reference Informations:**

- \*Material: PBT, UL94V-0
- \*Terminal Material: Phosphor Bronze/Tin over Nickel
- \*Color: Black

**Ordering Information:**

- A2550WRF-XP - \*\*\*
- |   |   |
|---|---|
| 1 | 2 |
|---|---|
- 1. Part No.
  - 2. Material:  
(blank): PBT, UL94V-0  
GWT: PBT, UL94V-0, GWT 750°C

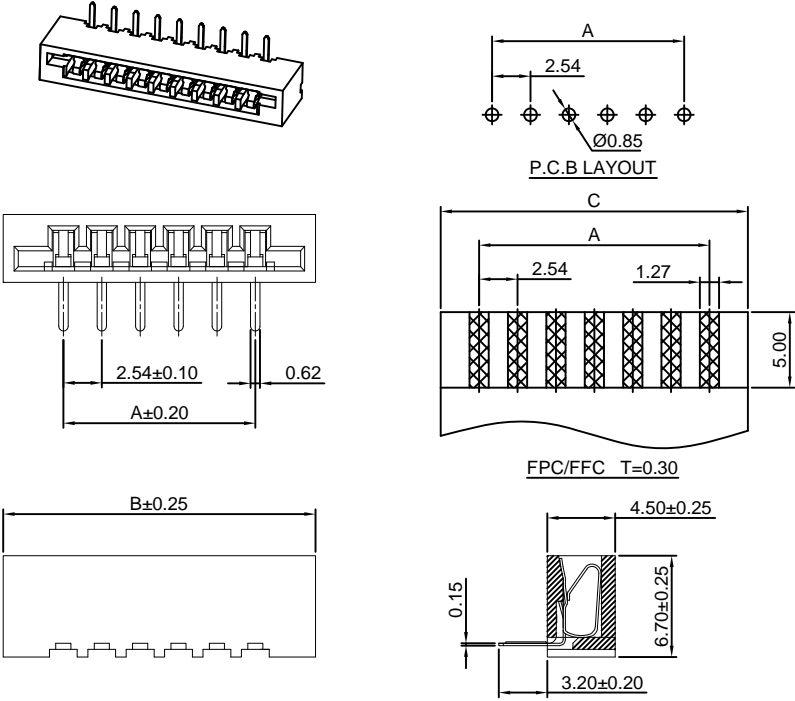

**Ordering Information & Dimensions:**

PART NO.	Dimensions		
	A	B	C
3P	5.08	13.04	10.16
4P	7.62	15.58	12.70
5P	10.16	18.12	15.24
6P	12.70	20.66	17.78
7P	15.24	23.20	20.32
8P	17.78	25.74	22.86
9P	20.32	28.28	25.40
10P	22.86	30.82	27.94
11P	25.40	33.36	30.48
12P	27.94	35.90	33.02
13P	30.48	38.44	35.56
14P	33.02	40.98	38.10
15P	35.56	43.52	40.64
16P	38.10	46.06	43.18
17P	40.64	48.60	45.72
18P	43.18	51.14	48.26
19P	45.72	53.68	50.80
20P	48.26	56.22	53.34
21P	50.80	58.76	55.88
22P	53.34	61.30	58.42
23P	55.88	63.84	60.96
24P	58.42	66.38	63.50
25P	60.96	68.92	66.04

Unit: mm

## A2550WVFD-F-XP

2.54mm Pitch Crimp Flex Wafer

**Reference Informations:**

- \*Material: Nylon 66, UL94V-0
- \*Terminal Material: Phosphor Bronze/Tin over Nickel
- \*Color: White

**Ordering Information:**

- A2550WVFD-F-XP - \*\*\*
- |   |   |
|---|---|
| 1 | 2 |
|---|---|
- 1. Part No.
  - 2. Material:  
(blank): Nylon 66, UL94V-0  
GWT: Nylon 66, UL94V-0, GWT 750°C

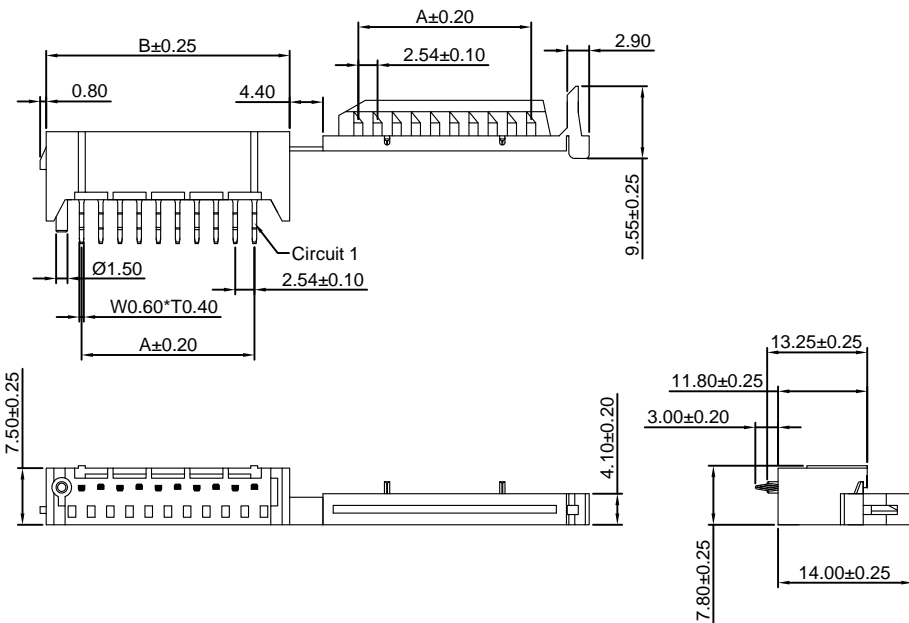

**Ordering Information & Dimensions:**

PART NO.	Dimensions	
	A	B
1P	---	9.34
2P	2.54	11.88
3P	5.08	14.42
4P	7.62	16.96
5P	10.16	19.50
6P	12.70	22.04
7P	15.24	24.58
8P	17.78	27.12
9P	20.32	29.66
10P	22.86	32.20
11P	25.40	34.74
12P	27.94	37.28
13P	30.48	39.82
14P	33.02	42.36
15P	35.56	44.90
16P	38.10	47.44
17P	40.64	49.98
18P	43.18	52.52
19P	45.72	55.06
20P	48.26	57.60
21P	50.80	60.14
22P	53.34	62.68
23P	55.88	65.22
24P	58.42	67.76
25P	60.96	70.30

Unit: mm

## A2550WRFD-XP

2.54mm Pitch Crimp Flex Wafer

### Reference Informations:

- \*Material:Nylon 66,UL94V-0
- \*Terminal Material:Phosphor Bronze/Tin over Nickel
- \*Color:White

### Ordering Information:

- A2550WRFD-XP - \*\*\*  
 1 2  
 1.Part No.  
 2.Material:  
 (blank):Nylon 66,UL94V-0  
 GWT:Nylon 66,UL94V-0,GWT 750°C

### Ordering Information & Dimensions:

PART NO.	Dimensions	
	A	B
1P	----	9.34
2P	2.54	11.88
3P	5.08	14.42
4P	7.62	16.96
5P	10.16	19.50
6P	12.70	22.04
7P	15.24	24.58
8P	17.78	27.12
9P	20.32	29.66
10P	22.86	32.20
11P	25.40	34.74
12P	27.94	37.28
13P	30.48	39.82
14P	33.02	42.36
15P	35.56	44.90
16P	38.10	47.44
17P	40.64	49.98
18P	43.18	52.52
19P	45.72	55.06
20P	48.26	57.60
21P	50.80	60.14
22P	53.34	62.68
23P	55.88	65.22
24P	58.42	67.76
25P	60.96	70.30

Unit: mm

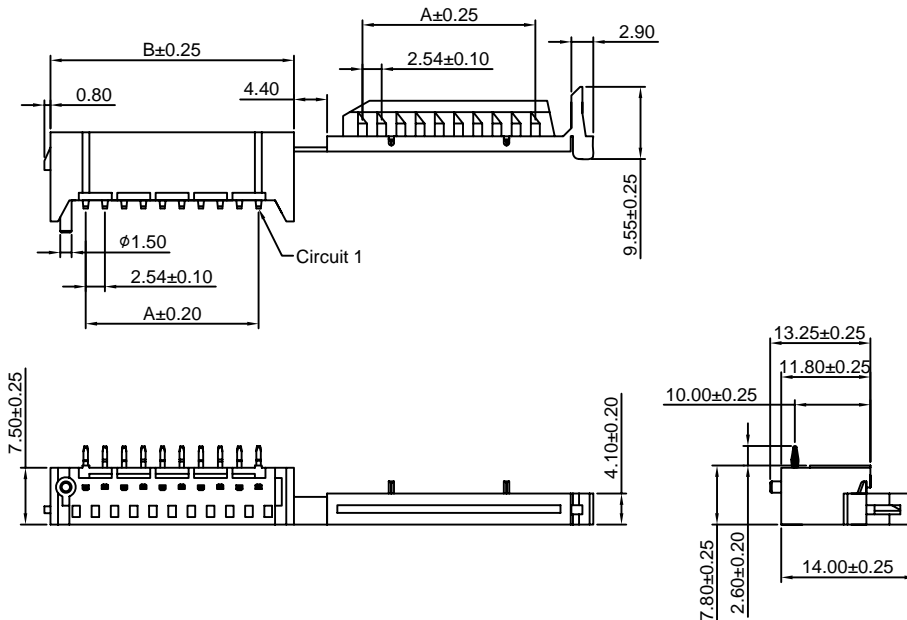

## A2550WVFC-F-XP

2.54mm Pitch Crimp Flex Wafer

### Reference Informations:

- \*Material:PBT,UL94V-0
- \*Terminal Material:Phosphor Bronze/Tin over Nickel
- \*Color:Blue

### Ordering Information:

- A2550WVFC-F-XP - \*\*\*  
 1 2  
 1.Part No.  
 2.Material:  
 (blank):PBT,UL94V-0  
 GWT:PBT,UL94V-0,GWT 750°C

### Ordering Information & Dimensions:

PART NO.	Dimensions			
	A	B	C	D
8P	17.78	30.34	23.12	10.16
9P	20.32	32.88	25.66	12.70
10P	22.86	35.42	28.20	15.24
11P	25.40	37.96	30.74	17.78
12P	27.94	40.50	33.28	20.32
13P	30.48	43.04	35.82	22.86

Unit: mm

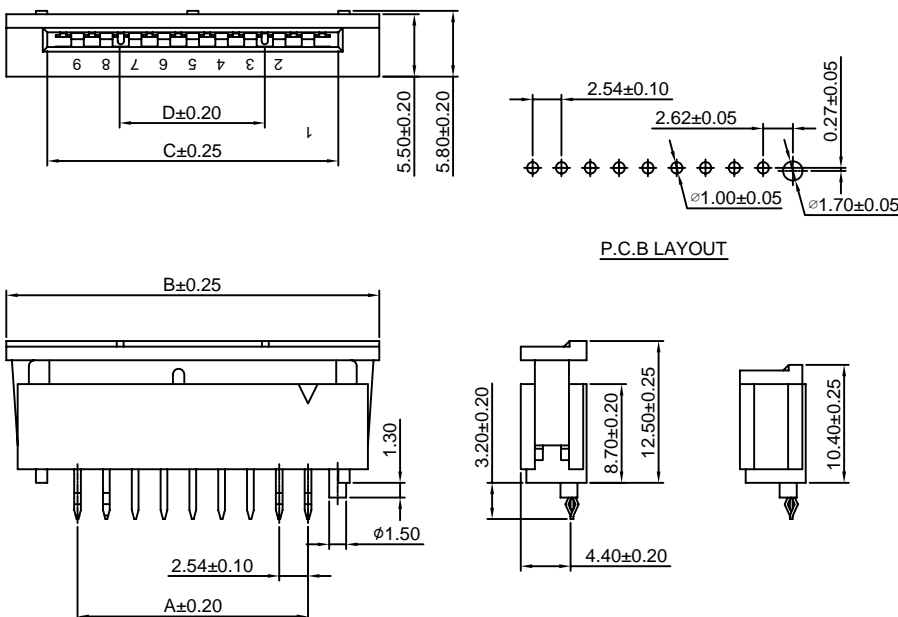

#### A2550HXXP-L-01

2.54mm Pitch FFC Cable

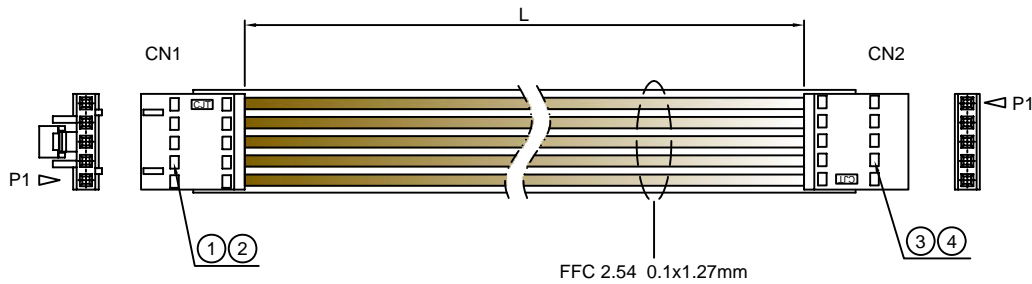

CN1 CN2	
① Terminal	② Housing
	A2550H,HA,HB-XP
A2550-T	A2550H-XP-A,A2550H-XP-A1
A2550-T-H	A2550H-XP-A2,A2550H-XP-A2H
A2550-T-CR	A2550H-XP-A3H,A2550H-XP-B
A2550-T-H-CR	A2550H-XP-BH
A2550-T-A	A2550H-XP-C,A2550H-XP-C1
A2550-T-C	A2550H-XP-D,A2550H-XP-E
	A2550H-XP-F,A2550H-XP-J
	A2550H,HA-2xXP
A2550-T-E	A2550H-XP-M,A2550H-XP-M1
	A2550H-XP-M2,A2550H-XP-M3
A2550-T-J	A2550H-XP-G,A2550H-XP-G1
	A2550H-XP-H,A2550H-XP-H1
	A2550H-XP-I,A2550H-XP-I1
A2550-T-K	A2550HK-XP,A2550HK-2xXP
A2550M-T	A2550H-XP,A2550H-XP-D
	A2550H-XP-J,A2550H-2xXP

Unit: mm

#### A2550HXXPA2550MXX-L-01

2.54mm Pitch FFC Cable

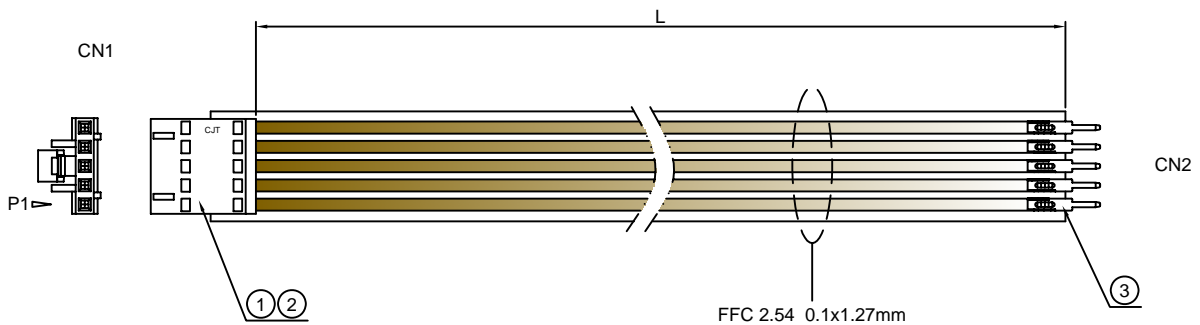

① Terminal	CN1		CN2
	② Housing	③ Terminal	
	A2550H,HA,HB-XP		
A2550-T	A2550H-XP-A,A2550H-XP-A1		
A2550-T-H	A2550H-XP-A2,A2550H-XP-A2H		
A2550-T-CR	A2550H-XP-A3H,A2550H-XP-B		
A2550-T-H-CR	A2550H-XP-BH		
A2550-T-A	A2550H-XP-C,A2550H-XP-C1	A2550M-T-C, A2550M-T-CA	
A2550-T-C	A2550H-XP-D,A2550H-XP-E	A2550M-T-C1, A2550M-T-C1A	
	A2550H-XP-F,A2550H-XP-J	A2550M-T-C2, A2550M-T-E	
	A2550H,HA-2xXP	A2550M-T-KE, A2550M-T-F	
A2550-T-E	A2550H-XP-M,A2550H-XP-M1	A2550M-T-G, A2550MA-T-G	
	A2550H-XP-M2,A2550H-XP-M3	A2550M-T-J, A2550M-T-K	
A2550-T-J	A2550H-XP-G,A2550H-XP-G1		
	A2550H-XP-H,A2550H-XP-H1		
	A2550H-XP-I,A2550H-XP-I1		
A2550-T-K	A2550HK-XP,A2550HK-2xXP		
A2550M-T	A2550H-XP,A2550H-XP-D		
	A2550H-XP-J,A2550H-2xXP		

Unit: mm

## X-ON Electronics

Largest Supplier of Electrical and Electronic Components

*Click to view similar products for [Headers & Wire Housings](#) category:*

*Click to view products by [Changjiang](#) manufacturer:*

Other Similar products are found below :

[95000-104TRLF](#) [10135584-644402LF](#) [DF62W-EP2022PCA](#) [95000-106TRLF](#) [DF62W-2022SCA](#) [DF62W-EP2022PC](#) [2203348](#) [DF62W-2022SC](#) [1084018](#) [1029039](#) [1084017](#) [802-10-012-10-002000](#) [1112640](#) [1112639](#) [891-007-9SS-BST1T](#) [000-34000](#) [0008550134](#) [0009482033](#) [0009507031](#) [57102-F02-18ULF](#) [57102-S06-03LF](#) [57202-S52-04LF](#) [PCN6-15S-2.5E](#) [0039019024](#) [58102-G61-06LF](#) [582553-1](#) [0009485154](#) [0009508121](#) [0022285053](#) [0050291907](#) [018731A](#) [LY20-4P-DT1-P1E-BR](#) [02.125.8002.8](#) [60101931](#) [60598-1 \(Cut Strip\)](#) [M1625-3R/100](#) [61062-3](#) [61082-181009](#) [CSU011177004](#) [636-1427](#) [638009-1](#) [641938-9](#) [641991-4](#) [644168-1](#) [644827-2](#) [647662-1](#) [65039-019ELF](#) [65692-001LF](#) [65781-018](#) [65781-047](#)