



## Specifications

- Current rating: 3A AC, DC
- Voltage rating: 300V AC, DC
- Temperature range: -40°C ~ +105°C
- Contact resistance: 5mΩ Max.
- Insulation resistance: 1000MΩ Min.
- Withstanding voltage: 1100V AC/minute
- \*Compliant with RoHS and REACH\*
- \*Meet the HF/Halogen Free, need to customize\*
- \*Contact CJT for details\*

## Standards



## Contact Layout

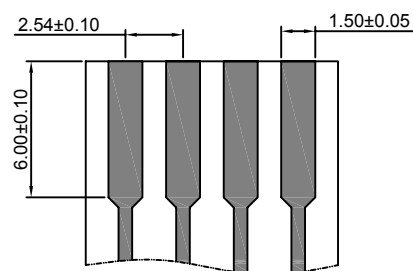

### A2550-T

2.54mm Pitch High Insertion Force Crimp Terminal

**Reference Informations:**

\*Used in CJT A2550 series Housing

Use With CJT A2550 series Housing:

|            |  |
|------------|--|
| Single Row | A2550H-XP,A2550HA-XP,A2550HB-XP,A2550H-XP-A      |
|            | A2550H-XP-B,A2550H-XP-C,A2550H-XP-C1,A2550H-XP-D |
|            | A2550H-XP-E,A2550H-XP-F,A2550H-XP-J              |
| Dual Row   | A2550H-2xXP,A2550HA-2xXP                         |

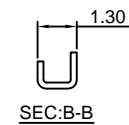
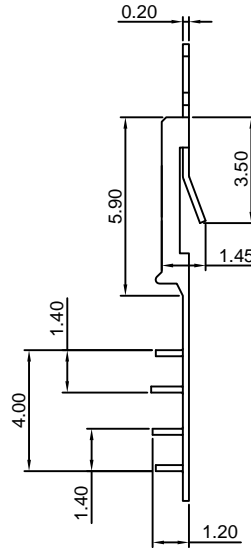
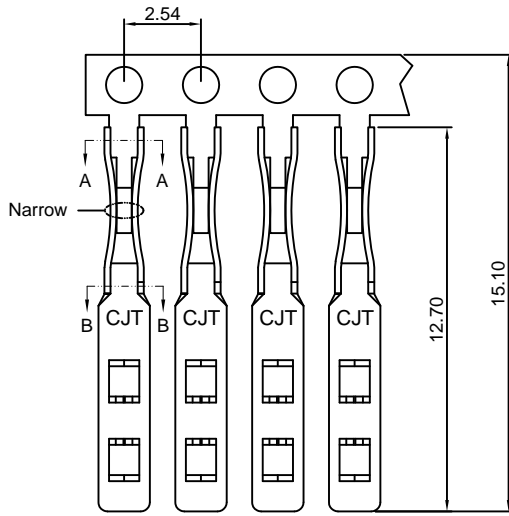

**Ordering information & Specifications:**

Unit:mm

| Part NO. | Wire Range | Insulation O.D. | Material        | Finish           | Qty/reel   |
|----------|------------|-----------------|-----------------|------------------|------------|
| A2550-TP | FFC WIRE   | -----           | Phosphor Bronze | Tin over Nickel  | 20,000 PCS |
| A2550-GP | FFC WIRE   | -----           | Phosphor Bronze | Gold over Nickel | 20,000 PCS |

Optional Gold plating available but MOQ requested

### A2550-T-H

2.54mm Pitch Low insertion Force Crimp Terminal

**Reference Informations:**

\*Used in CJT A2550 series Housing

Use With CJT A2550 series Housing:

|            |  |
|------------|--|
| Single Row | A2550H-XP,A2550HA-XP,A2550HB-XP,A2550H-XP-A      |
|            | A2550H-XP-B,A2550H-XP-C,A2550H-XP-C1,A2550H-XP-D |
|            | A2550H-XP-E,A2550H-XP-F,A2550H-XP-J              |
| Dual Row   | A2550H-2xXP,A2550HA-2xXP                         |

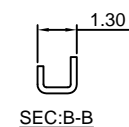
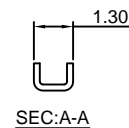
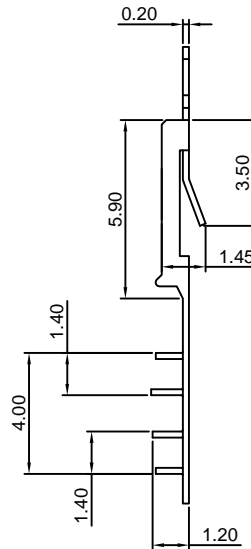

**Ordering information & Specifications:**

Unit:mm

| Part NO.   | Wire Range | Insulation O.D. | Material        | Finish           | Qty/reel   |
|------------|------------|-----------------|-----------------|------------------|------------|
| A2550-TP-H | FFC WIRE   | -----           | Phosphor Bronze | Tin over Nickel  | 20,000 PCS |
| A2550-GP-H | FFC WIRE   | -----           | Phosphor Bronze | Gold over Nickel | 20,000 PCS |

Optional Gold plating available but MOQ requested

### A2550-T-CR

2.54mm Pitch High Insertion Force Crimp Terminal

**Reference Informations:**

\*Used in CJT A2550 series Housing

Use With CJT A2550 series Housing:

|            |  |
|------------|--|
| Single Row | A2550H-XP,A2550HA-XP,A2550HB-XP,A2550H-XP-A      |
|            | A2550H-XP-B,A2550H-XP-C,A2550H-XP-C1,A2550H-XP-D |
|            | A2550H-XP-E,A2550H-XP-F,A2550H-XP-J              |
| Dual Row   | A2550H-2xXP,A2550HA-2xXP                         |



Ordering information & Specifications:

Unit:mm

| Part NO.    | Wire Range | Insulation O.D. | Material        | Finish           | Qty/reel   |
|-------------|------------|-----------------|-----------------|------------------|------------|
| A2550-TP-CR | FFC WIRE   | -----           | Phosphor Bronze | Tin over Nickel  | 20,000 PCS |
| A2550-GP-CR | FFC WIRE   | -----           | Phosphor Bronze | Gold over Nickel | 20,000 PCS |

Optional Gold plating available but MOQ requested

### A2550-T-H-CR

2.54mm Pitch Low insertion Force Crimp Terminal

**Reference Informations:**

\*Used in CJT A2550 series Housing

Use With CJT A2550 series Housing:

|            |  |
|------------|--|
| Single Row | A2550H-XP,A2550HA-XP,A2550HB-XP,A2550H-XP-A      |
|            | A2550H-XP-B,A2550H-XP-C,A2550H-XP-C1,A2550H-XP-D |
|            | A2550H-XP-E,A2550H-XP-F,A2550H-XP-J              |
| Dual Row   | A2550H-2xXP,A2550HA-2xXP                         |

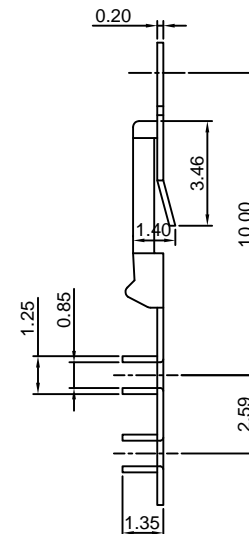

Ordering information & Specifications:

Unit:mm

| Part NO.      | Wire Range | Insulation O.D. | Material        | Finish           | Qty/reel   |
|---------------|------------|-----------------|-----------------|------------------|------------|
| A2550-TP-H-CR | FFC WIRE   | -----           | Phosphor Bronze | Tin over Nickel  | 20,000 PCS |
| A2550-GP-H-CR | FFC WIRE   | -----           | Phosphor Bronze | Gold over Nickel | 20,000 PCS |

Optional Gold plating available but MOQ requested

### A2550-T-A

2.54mm pitch Crimp Flex Terminal

**Reference Informations:**

\*Used in CJT A2550 series Housing

Use With CJT A2550 series Housing:

|            |   |
|------------|---|
| Single Row | A2550H-XP, A2550HA-XP, A2550HB-XP, A2550H-XP-A      |
|            | A2550H-XP-B, A2550H-XP-C, A2550H-XP-C1, A2550H-XP-D |
|            | A2550H-XP-E, A2550H-XP-F, A2550H-XP-J               |
| Dual Row   | A2550H-2xXP, A2550HA-2xXP                           |

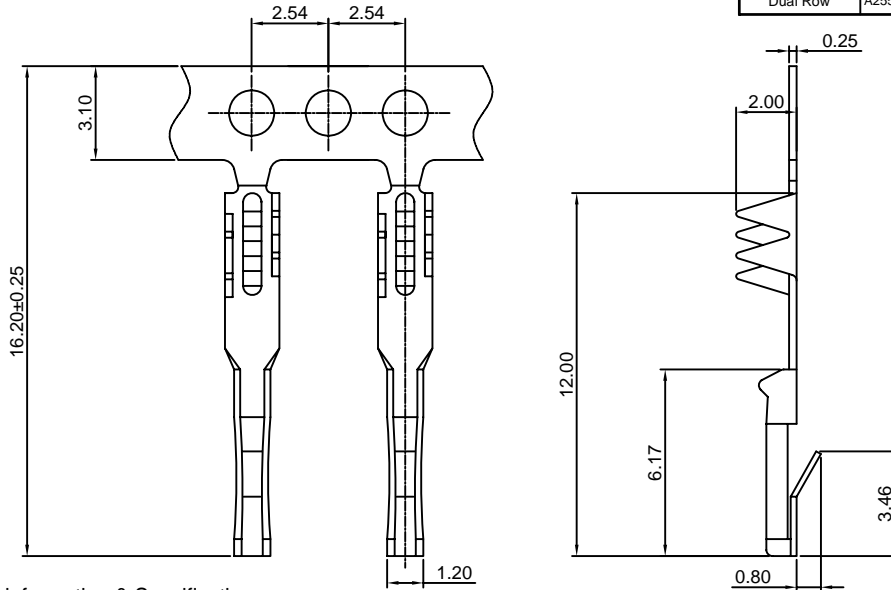

Ordering information & Specifications:

Unit:mm

| Part NO.   | Wire Range | Insulation O.D. | Material        | Finish           | Qty/reel   |
|------------|------------|-----------------|-----------------|------------------|------------|
| A2550-TP-A | FFC WIRE   | -----           | Phosphor Bronze | Tin over Nickel  | 10,000 PCS |
| A2550-GP-A | FFC WIRE   | -----           | Phosphor Bronze | Gold over Nickel | 10,000 PCS |

Optional Gold plating available but MOQ requested

### A2550-T-C

2.54mm Pitch Hi-Flex Crimp Terminal

**Reference Informations:**

\*Used in CJT A2550 series Housing

\*The Hi-Flex female contact designed to offer a stable insertion force and low contact resistance over larger number of mating cycles

\*More resistant to damage by bent or angled pins, primarily on test devices

Use With CJT A2550 series Housing:

|            |   |
|------------|---|
| Single Row | A2550H-XP, A2550HA-XP, A2550HB-XP, A2550H-XP-A      |
|            | A2550H-XP-B, A2550H-XP-C, A2550H-XP-C1, A2550H-XP-D |
|            | A2550H-XP-E, A2550H-XP-F, A2550H-XP-J               |
| Dual Row   | A2550H-2xXP, A2550HA-2xXP                           |

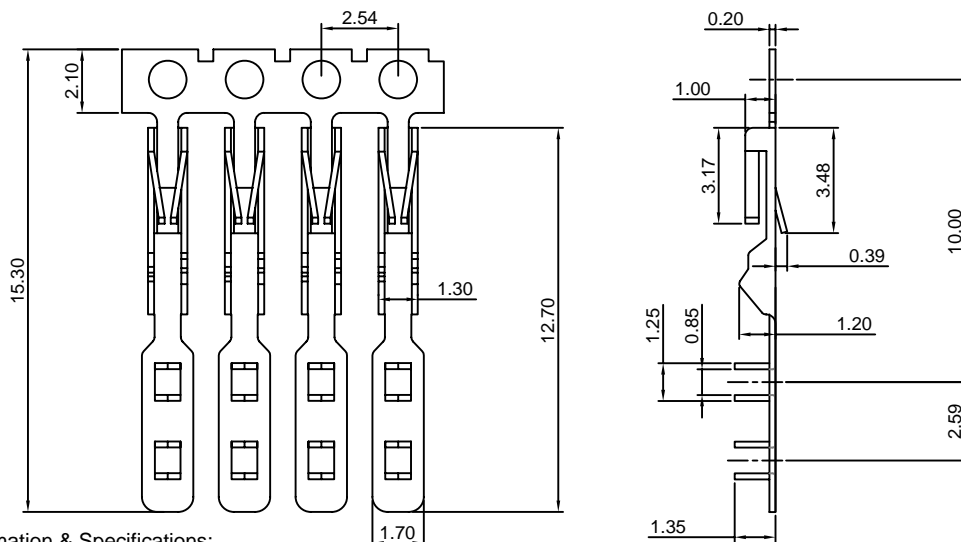

Ordering information & Specifications:

Unit:mm

| Part NO.   | Wire Range | Insulation O.D. | Material        | Finish           | Qty/reel   |
|------------|------------|-----------------|-----------------|------------------|------------|
| A2550-TP-C | FFC WIRE   | -----           | Phosphor Bronze | Tin over Nickel  | 20,000 PCS |
| A2550-GP-C | FFC WIRE   | -----           | Phosphor Bronze | Gold over Nickel | 20,000 PCS |

Optional Gold plating available but MOQ requested

### A2550-T-D

2.54mm pitch Crimp Flex Terminal

**Reference Informations:**

\*Designed for Soldering directly to Flexible PCB or Ultra Thin Rigged PCBs



Ordering information & Specifications:

Unit:mm

| Part NO.   | Wire Range | Insulation O.D. | Material        | Finish           | Qty/reel   |
|------------|------------|-----------------|-----------------|------------------|------------|
| A2550-TP-D | PCBs       | -----           | Phosphor Bronze | Tin over Nickel  | 20,000 PCS |
| A2550-GP-D | PCBs       | -----           | Phosphor Bronze | Gold over Nickel | 20,000 PCS |

Optional Gold plating available but MOQ requested

### A2550-T-E

2.54mm pitch Crimp Flex Terminal

**Reference Informations:**

\*Used in CJT A2550 series Housing

Use With CJT A2550 series Housing :

|            |  |
|------------|--|
| Single Row | A2550H-XP-M A2550H-XP-M1 A2550H-XP-M2 A2550H-XP-MH |
|            | A2550H-XP-M3                                       |

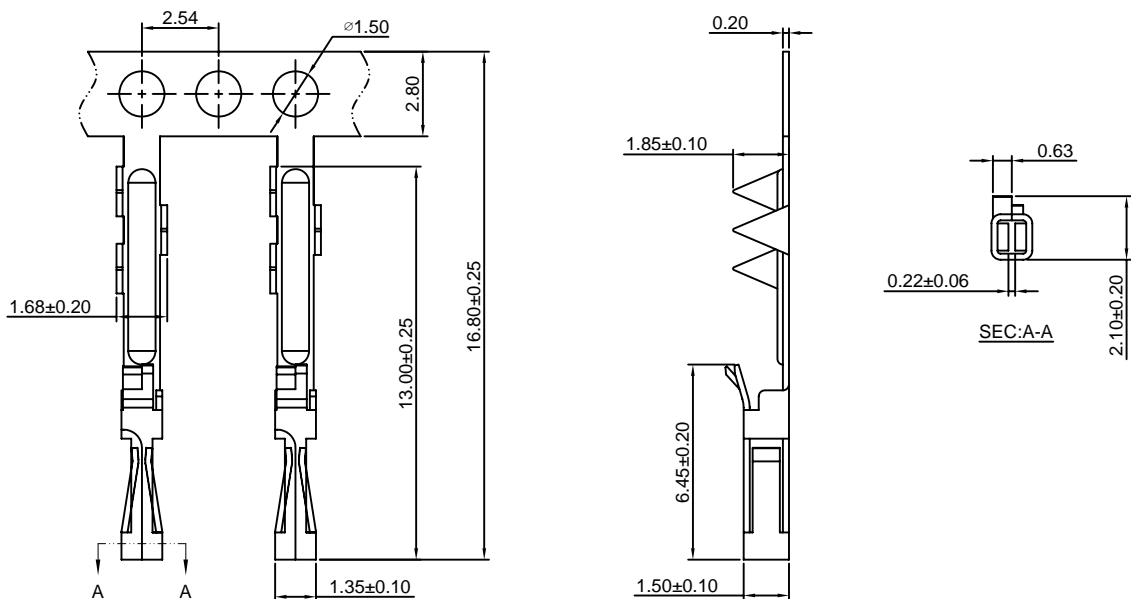

Ordering information & Specifications:

Unit:mm

| Part NO.   | Wire Range | Insulation O.D. | Material        | Finish           | Qty/reel   |
|------------|------------|-----------------|-----------------|------------------|------------|
| A2550-TP-E | FFC WIRE   | -----           | Phosphor Bronze | Tin over Nickel  | 15,000 PCS |
| A2550-GP-E | FFC WIRE   | -----           | Phosphor Bronze | Gold over Nickel | 15,000 PCS |

Optional Gold plating available but MOQ requested

### A2550-T-F

2.54mm pitch Crimp Flex Terminal

**Reference Informations:**

\*Used in FFC Wire and Electronic wire

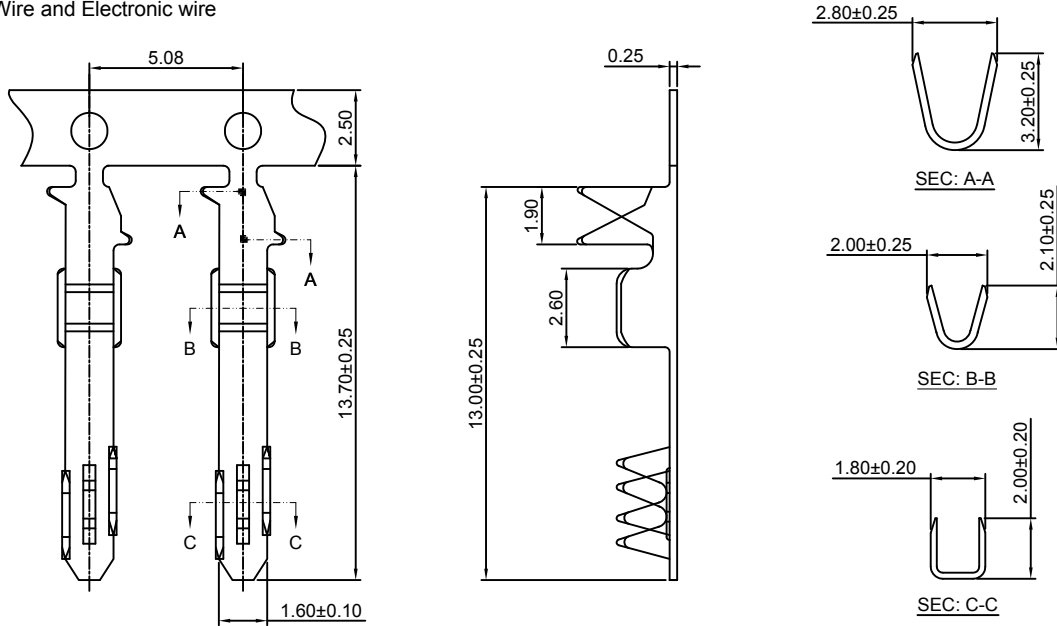

Ordering information & Specifications:

Unit:mm

| Part NO.   | Wire Range          | Insulation O.D. | Material        | Finish           | Qty/reel   |
|------------|---------------------|-----------------|-----------------|------------------|------------|
| A2550-TP-F | FFC WIRE/AWG#20-#26 | 1.80mm(max)     | Phosphor Bronze | Tin over Nickel  | 15,000 PCS |
| A2550-GP-F | FFC WIRE/AWG#20-#26 | 1.80mm(max)     | Phosphor Bronze | Gold over Nickel | 15,000 PCS |

Optional Gold plating available but MOQ requested

### A2550-T-J

2.54mm pitch Crimp Flex Terminal

**Reference Informations:**

\*Used in CJT A2550 series Housing

Use With CJT A2550 series Housing:

|            |                                       |
|------------|---------------------------------------|
| Single Row | A2550H-XP-G, A2550H-XP-H, A2550H-XP-I |
|------------|---------------------------------------|

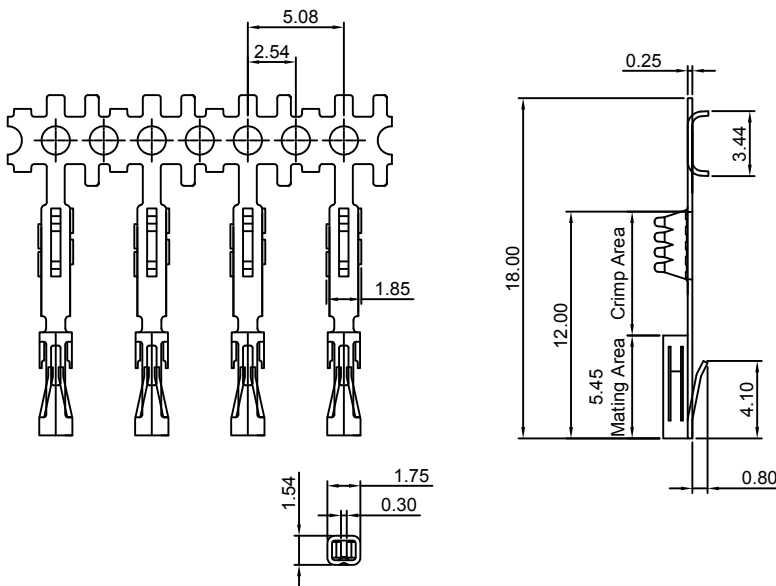

Ordering Information:

A2550-GP-J - \*\*\*  
1 2

1.Part No.

2.Finish

TG :Mating Area : 100µin (2.54µm) MIN. Tin

Crimp Area : 1µin (0.025µm) MIN. Gold

GT15 :Mating Area : 15µin (0.38µm) MIN. Gold

Crimp Area : 100µin (2.54µm) MIN. Tin

GT30 :Mating Area : 30µin (0.76µm) MIN. Gold

Crimp Area : 100µin (2.54µm) MIN. Tin

GT50 :Mating Area : 50µin (1.27µm) MIN. Gold

Crimp Area : 100µin (2.54µm) MIN. Tin

GG15 :Mating Area : 15µin (0.38µm) MIN. Gold

Crimp Area : 1µin (0.025µm) MIN. Gold

GG30 :Mating Area : 30µin (0.76µm) MIN. Gold

Crimp Area : 1µin (0.025µm) MIN. Gold

GG50 :Mating Area : 50µin (1.27µm) MIN. Gold

Crimp Area : 1µin (0.025µm) MIN. Gold

Ordering information & Specifications:

Unit:mm

| Part NO.   | Wire Range | Insulation O.D. | Material        | Finish           | Qty/reel   |
|------------|------------|-----------------|-----------------|------------------|------------|
| A2550-TP-J | FFC WIRE   | -----           | Phosphor Bronze | Tin over Nickel  | 10,000 PCS |
| A2550-GP-J | FFC WIRE   | -----           | Phosphor Bronze | Gold over Nickel | 10,000 PCS |

Optional Gold plating available but MOQ requested

### A2550-T-K

2.54mm pitch Crimp Flex Terminal

**Reference Informations:**

\*Used in CJT A2550HK series Housing

Use With CJT A2550 series Housing:

|            |              |
|------------|--------------|
| Single Row | A2550HK-XP   |
| Dual Row   | A2550HK-2xXP |



Ordering information & Specifications:

Unit:mm

| Part NO.   | Wire Range | Insulation O.D. | Material        | Finish           | Qty/reel   |
|------------|------------|-----------------|-----------------|------------------|------------|
| A2550-TP-K | FFC WIRE   | -----           | Phosphor Bronze | Tin over Nickel  | 20,000 PCS |
| A2550-GP-K | FFC WIRE   | -----           | Phosphor Bronze | Gold over Nickel | 20,000 PCS |

Optional Gold plating available but MOQ requested

### A2550M-T

2.54mm pitch Crimp Flex Terminal

**Reference Informations:**

\*Used in CJT A2550 series Housing

Use With CJT A2550 series Housing:

|            |                        |
|------------|------------------------|
| Single Row | A2550H-XP, A2550H-XP-D |
| Dual Row   | A2550H-2xXP            |



Ordering information & Specifications:

Unit:mm

| Part NO.  | Wire Range | Insulation O.D. | Material        | Finish           | Qty/reel   |
|-----------|------------|-----------------|-----------------|------------------|------------|
| A2550M-TP | FFC WIRE   | -----           | Phosphor Bronze | Tin over Nickel  | 10,000 PCS |
| A2550M-GP | FFC WIRE   | -----           | Phosphor Bronze | Gold over Nickel | 10,000 PCS |

Optional Gold plating available but MOQ requested

### A2550M-T-C

2.54mm pitch Crimp Flex Terminal

**Reference Informations:**

\*Used in FFC Wire

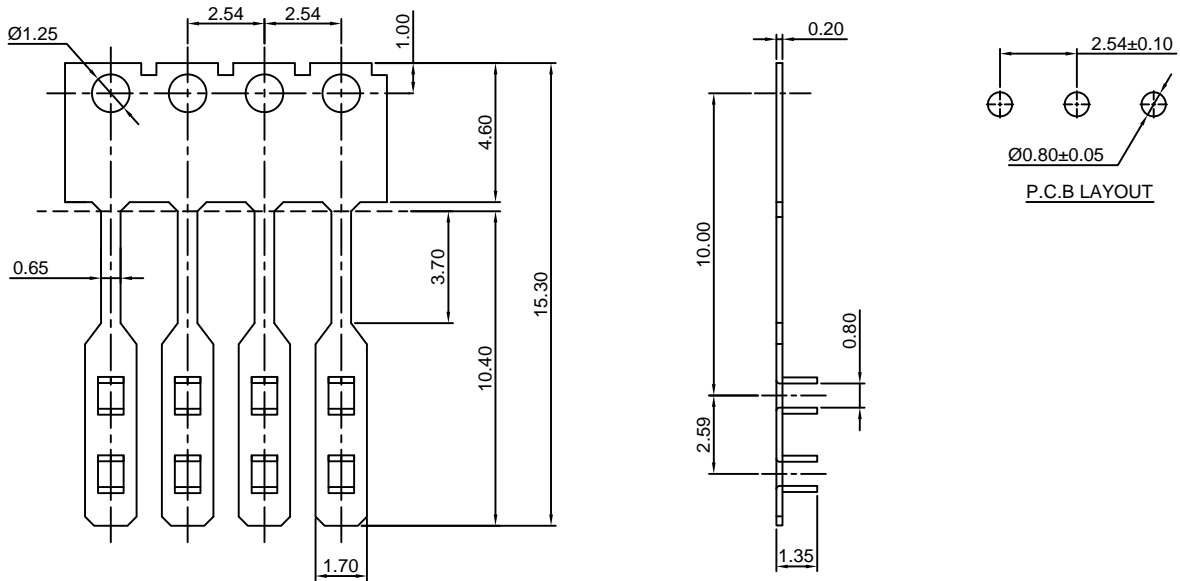

**Ordering information & Specifications:**

Unit:mm

| Part NO.    | Wire Range | Insulation O.D. | Material        | Finish           | Qty/reel   |
|-------------|------------|-----------------|-----------------|------------------|------------|
| A2550M-TP-C | FFC WIRE   | -----           | Phosphor Bronze | Tin over Nickel  | 20,000 PCS |
| A2550M-GP-C | FFC WIRE   | -----           | Phosphor Bronze | Gold over Nickel | 20,000 PCS |

Optional Gold plating available but MOQ requested

### A2550M-T-CA

2.54mm pitch Crimp Flex Terminal

**Reference Informations:**

\*Used in FFC Wire

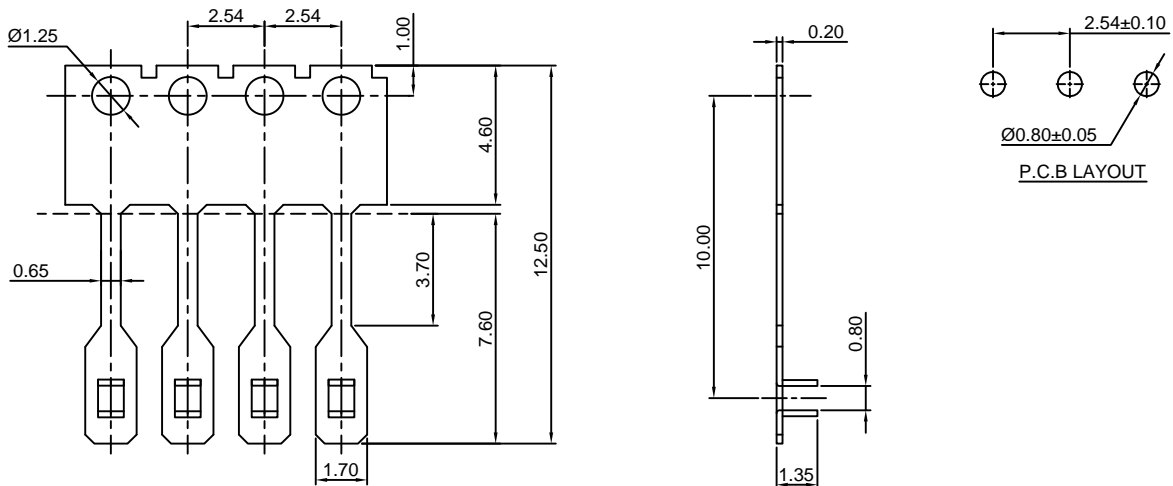

**Ordering information & Specifications:**

Unit:mm

| Part NO.     | Wire Range | Insulation O.D. | Material        | Finish           | Qty/reel   |
|--------------|------------|-----------------|-----------------|------------------|------------|
| A2550M-TP-CA | FFC WIRE   | -----           | Phosphor Bronze | Tin over Nickel  | 20,000 PCS |
| A2550M-GP-CA | FFC WIRE   | -----           | Phosphor Bronze | Gold over Nickel | 20,000 PCS |

Optional Gold plating available but MOQ requested



### A2550M-T-C1

2.54mm pitch Crimp Flex Terminal

**Reference Informations:**

\*Used in FFC Wire

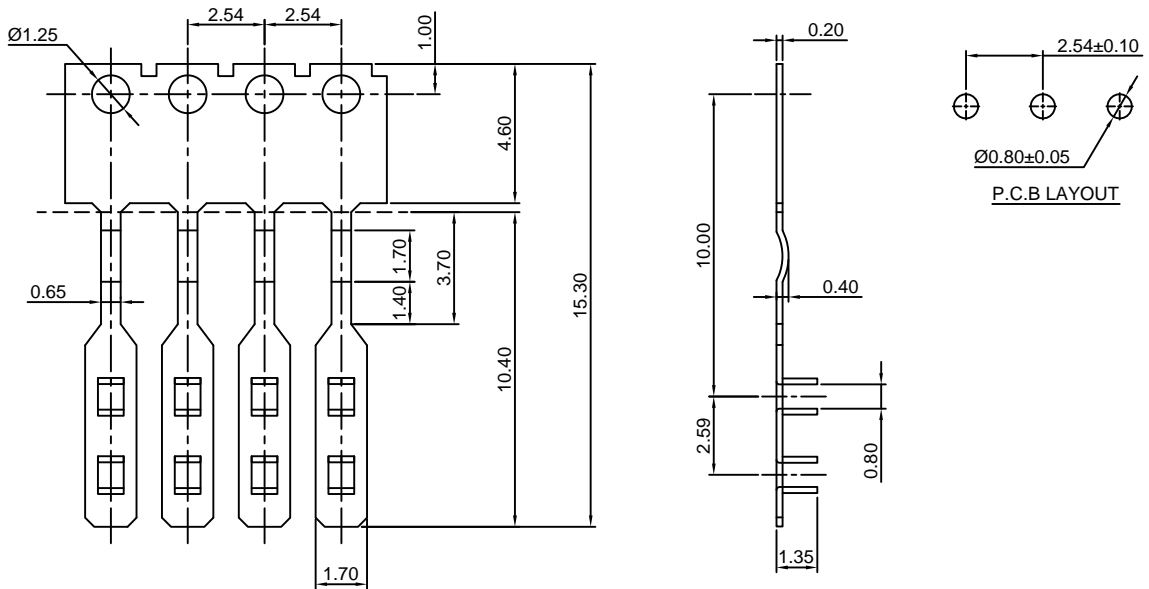

Ordering information & Specifications:

Unit:mm

| Part NO.     | Wire Range | Insulation O.D. | Material        | Finish           | Qty/reel   |
|--------------|------------|-----------------|-----------------|------------------|------------|
| A2550M-TP-C1 | FFC WIRE   | -----           | Phosphor Bronze | Tin over Nickel  | 20,000 PCS |
| A2550M-GP-C1 | FFC WIRE   | -----           | Phosphor Bronze | Gold over Nickel | 20,000 PCS |

Optional Gold plating available but MOQ requested

### A2550M-T-C1A

2.54mm pitch Crimp Flex Terminal

**Reference Informations:**

\*Used in FFC Wire

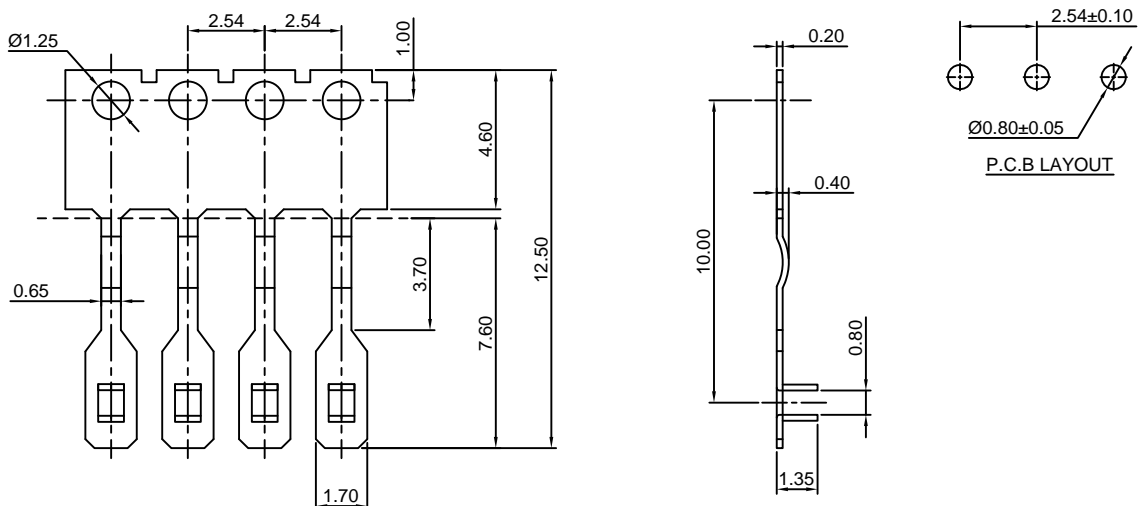

Ordering information & Specifications:

Unit:mm

| Part NO.      | Wire Range | Insulation O.D. | Material        | Finish           | Qty/reel   |
|---------------|------------|-----------------|-----------------|------------------|------------|
| A2550M-TP-C1A | FFC WIRE   | -----           | Phosphor Bronze | Tin over Nickel  | 20,000 PCS |
| A2550M-GP-C1A | FFC WIRE   | -----           | Phosphor Bronze | Gold over Nickel | 20,000 PCS |

Optional Gold plating available but MOQ requested

### A2550M-T-C2

2.54mm pitch Crimp Flex Terminal

**Reference Informations:**

\*Used in FFC Wire



**Ordering information & Specifications:**

Unit:mm

| Part NO.     | Wire Range | Insulation O.D. | Material        | Finish           | Qty/reel   |
|--------------|------------|-----------------|-----------------|------------------|------------|
| A2550M-TP-C2 | FFC WIRE   | -----           | Phosphor Bronze | Tin over Nickel  | 20,000 PCS |
| A2550M-GP-C2 | FFC WIRE   | -----           | Phosphor Bronze | Gold over Nickel | 20,000 PCS |

Optional Gold plating available but MOQ requested

### A2550M-T-D

2.54mm pitch Crimp Flex Terminal

**Reference Informations:**

\*Used in CJT A2550HM A2550HMA

A2550H-M1 A2550H-M3 series Housing



**Ordering information & Specifications:**

Unit:mm

| Part NO.    | Wire Range | Insulation O.D. | Material        | Finish           | Qty/reel   |
|-------------|------------|-----------------|-----------------|------------------|------------|
| A2550M-TP-D | FFC WIRE   | -----           | Phosphor Bronze | Tin over Nickel  | 10,000 PCS |
| A2550M-GP-D | FFC WIRE   | -----           | Phosphor Bronze | Gold over Nickel | 10,000 PCS |

Optional Gold plating available but MOQ requested

**A2550M-T-E**

2.54mm pitch Crimp Flex Terminal

**Reference Informations:**

\*Used in FFC Wire



Ordering information & Specifications:

Unit:mm

| Part NO.    | Wire Range | Insulation O.D. | Material        | Finish           | Qty/reel   |
|-------------|------------|-----------------|-----------------|------------------|------------|
| A2550M-TP-E | FFC WIRE   | -----           | Phosphor Bronze | Tin over Nickel  | 10,000 PCS |
| A2550M-GP-E | FFC WIRE   | -----           | Phosphor Bronze | Gold over Nickel | 10,000 PCS |

Optional Gold plating available but MOQ requested

**A2550M-T-KE**

2.54mm pitch Crimp Flex Terminal

**Reference Informations:**

\*Used in FFC Wire



Ordering information & Specifications:

Unit:mm

| Part NO.     | Wire Range | Insulation O.D. | Material        | Finish           | Qty/reel   |
|--------------|------------|-----------------|-----------------|------------------|------------|
| A2550M-TP-KE | FFC WIRE   | -----           | Phosphor Bronze | Tin over Nickel  | 20,000 PCS |
| A2550M-GP-KE | FFC WIRE   | -----           | Phosphor Bronze | Gold over Nickel | 20,000 PCS |

Optional Gold plating available but MOQ requested

### A2550M-T-F

2.54mm pitch Crimp Flex Terminal

**Reference Informations:**

\*Used in FFC Wire

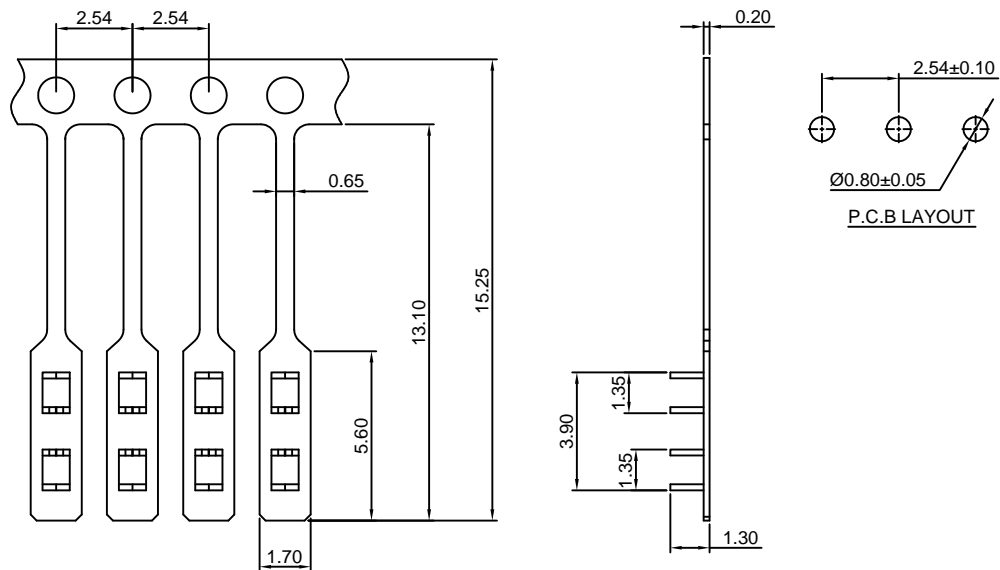

Ordering information & Specifications:

Unit:mm

| Part NO.    | Wire Range | Insulation O.D. | Material        | Finish           | Qty/reel   |
|-------------|------------|-----------------|-----------------|------------------|------------|
| A2550M-TP-F | FFC WIRE   | -----           | Phosphor Bronze | Tin over Nickel  | 20,000 PCS |
| A2550M-GP-F | FFC WIRE   | -----           | Phosphor Bronze | Gold over Nickel | 20,000 PCS |

Optional Gold plating available but MOQ requested

### A2550M-T-G

2.54mm pitch Crimp Flex Terminal

**Reference Informations:**

\*Used in FFC Wire



Ordering information & Specifications:

Unit:mm

| Part NO.    | Wire Range | Insulation O.D. | Material        | Finish           | Qty/reel   |
|-------------|------------|-----------------|-----------------|------------------|------------|
| A2550M-TP-G | FFC WIRE   | -----           | Phosphor Bronze | Tin over Nickel  | 20,000 PCS |
| A2550M-GP-G | FFC WIRE   | -----           | Phosphor Bronze | Gold over Nickel | 20,000 PCS |

Optional Gold plating available but MOQ requested

### A2550M-T-J

2.54mm pitch Crimp Flex Terminal

**Reference Informations:**

\*Used in FFC Wire



Ordering information & Specifications:

Unit:mm

| Part NO.    | Wire Range | Insulation O.D. | Material        | Finish           | Qty/reel   |
|-------------|------------|-----------------|-----------------|------------------|------------|
| A2550M-TP-J | FFC WIRE   | -----           | Phosphor Bronze | Tin over Nickel  | 20,000 PCS |
| A2550M-GP-J | FFC WIRE   | -----           | Phosphor Bronze | Gold over Nickel | 20,000 PCS |

Optional Gold plating available but MOQ requested

### A2550M-T-K

2.54mm pitch Crimp Flex Terminal

**Reference Informations:**

\*Used in FFC Wire



Ordering information & Specifications:

Unit:mm

| Part NO.    | Wire Range | Insulation O.D. | Material        | Finish           | Qty/reel   |
|-------------|------------|-----------------|-----------------|------------------|------------|
| A2550M-TP-K | FFC WIRE   | -----           | Phosphor Bronze | Tin over Nickel  | 20,000 PCS |
| A2550M-GP-K | FFC WIRE   | -----           | Phosphor Bronze | Gold over Nickel | 20,000 PCS |

Optional Gold plating available but MOQ requested

### A2550H-XP

2.54mm Pitch Crimp Flex Housing

**Reference Informations:**

- \*Material:PBT30%GF,UL94V-0
- \*Suitable CJT A2550 series Terminal (A2550-T(-H), A2550-T(-H)-CR, A2550-T-A, A2550-T-C, A2550M-T)
- \*Mates with CJT A2541 series Wafer
- \*Color:Black

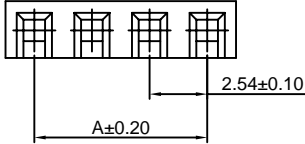
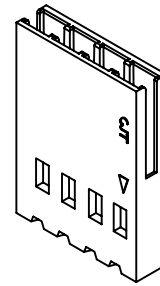

Ordering Information:  
A2550H-XP - \*\*\*  
 1 2  
 1.Part No.  
 2.Material:  
 (blank):PBT30%GF,UL94V-0  
 GWT:PBT,UL94V-0,GWT 750°C

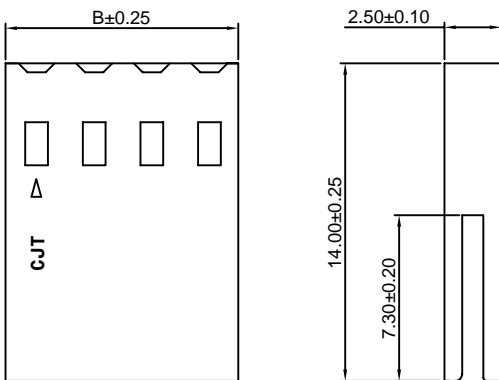

**Ordering Information & Dimensions:**

| PART NO. | Dimensions |       | PART NO. | Dimensions |       |
|----------|------------|-------|----------|------------|-------|
|          | A          | B     |          | A          | B     |
| 2P       | 2.54       | 5.08  | 20P      | 48.26      | 50.80 |
| 3P       | 5.08       | 7.62  | 21P      | 50.80      | 53.34 |
| 4P       | 7.62       | 10.16 | 22P      | 53.34      | 55.88 |
| 5P       | 10.16      | 12.70 | 23P      | 55.88      | 58.42 |
| 6P       | 12.70      | 15.24 | 24P      | 58.42      | 60.96 |
| 7P       | 15.24      | 17.78 | 25P      | 60.96      | 63.50 |
| 8P       | 17.78      | 20.32 | 26P      | 63.50      | 66.04 |
| 9P       | 20.32      | 22.86 | 27P      | 66.04      | 68.58 |
| 10P      | 22.86      | 25.40 | 28P      | 68.58      | 71.12 |
| 11P      | 25.40      | 27.94 | 29P      | 71.12      | 73.66 |
| 12P      | 27.94      | 30.48 | 30P      | 73.66      | 76.20 |
| 13P      | 30.48      | 33.02 | 31P      | 76.20      | 78.74 |
| 14P      | 33.02      | 35.56 | 32P      | 78.74      | 81.28 |
| 15P      | 35.56      | 38.10 | 33P      | 81.28      | 83.82 |
| 16P      | 38.10      | 40.64 | 34P      | 83.82      | 86.36 |
| 17P      | 40.64      | 43.18 | 35P      | 86.36      | 88.90 |
| 18P      | 43.18      | 45.72 | 36P      | 88.90      | 91.44 |
| 19P      | 45.72      | 48.26 |          |            |       |

Unit: mm

### A2550HH-XP

2.54mm Pitch Crimp Flex Housing

**Reference Informations:**

- \*Material:PBT30%GF,UL94V-0
- \*Suitable CJT A2550 series Terminal (A2550-T(-H), A2550-T(-H)-CR, A2550-T-A, A2550-T-C, A2550M-T)
- \*Mates with CJT A2541 series Wafer
- \*Color:Black

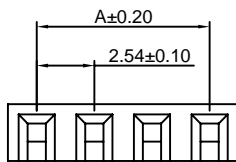
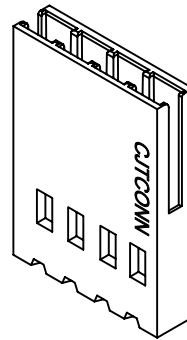

Ordering Information:  
A2550HH-XP - \*\*\*  
 1 2  
 1.Part No.  
 2.Material:  
 (blank):PBT30%GF,UL94V-0  
 GWT:PBT,UL94V-0,GWT 750°C

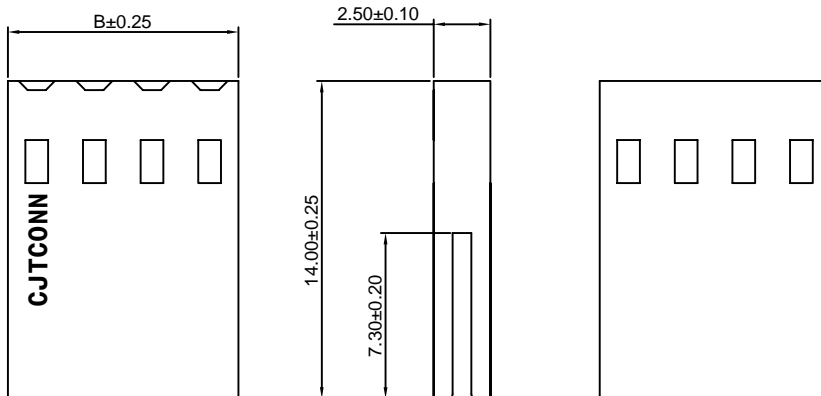

**Ordering Information & Dimensions:**

| PART NO. | Dimensions |       |
|----------|------------|-------|
|          | A          | B     |
| 2P       | 2.54       | 5.08  |
| 3P       | 5.08       | 7.62  |
| 4P       | 7.62       | 10.16 |
| 5P       | 10.16      | 12.70 |
| 6P       | 12.70      | 15.24 |
| 7P       | 15.24      | 17.78 |
| 8P       | 17.78      | 20.32 |
| 9P       | 20.32      | 22.86 |
| 10P      | 22.86      | 25.40 |
| 11P      | 25.40      | 27.94 |
| 12P      | 27.94      | 30.48 |
| 13P      | 30.48      | 33.02 |
| 14P      | 33.02      | 35.56 |
| 15P      | 35.56      | 38.10 |
| 16P      | 38.10      | 40.64 |
| 17P      | 40.64      | 43.18 |
| 18P      | 43.18      | 45.72 |
| 19P      | 45.72      | 48.26 |
| 20P      | 48.26      | 50.80 |
| 21P      | 50.80      | 53.34 |
| 22P      | 53.34      | 55.88 |
| 23P      | 55.88      | 58.42 |
| 24P      | 58.42      | 60.96 |
| 25P      | 60.96      | 63.50 |

Unit: mm









### A2550H-XP-A3

2.54mm Pitch Crimp Flex Housing

**Reference Informations:**

- \*Material: PBT30%GF,UL94V-0
- \*Suitable CJT A2550 series Terminal (A2550-T(-H), A2550-T(-H)-CR, A2550-T-A, A2550-T-C)
- \*Mates with CJT A2550HM-XP,A2547HM-XP series Housing or A2547WVA,WRA-XP series Wafer
- \*Color:Black

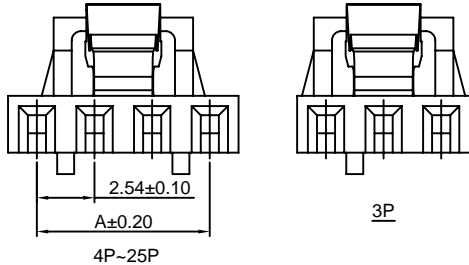

Ordering Information:  
A2550H-XP-A3 - \*\*\*  
 $\frac{1}{2}$   
 1.Part No.  
 2.Material:  
 (blank):PBT30%GF,UL94V-0  
 GWT:PBT,UL94V-0,GWT 750°C

**Ordering Information & Dimensions:**

| PART NO. | Dimensions |       |
|----------|------------|-------|
|          | A          | B     |
| 3P       | 5.08       | 7.62  |
| 4P       | 7.62       | 10.16 |
| 5P       | 10.16      | 12.70 |
| 6P       | 12.70      | 15.24 |
| 7P       | 15.24      | 17.78 |
| 8P       | 17.78      | 20.32 |
| 9P       | 20.32      | 22.86 |
| 10P      | 22.86      | 25.40 |
| 11P      | 25.40      | 27.94 |
| 12P      | 27.94      | 30.48 |
| 13P      | 30.48      | 33.02 |
| 14P      | 33.02      | 35.56 |
| 15P      | 35.56      | 38.10 |
| 16P      | 38.10      | 40.64 |
| 17P      | 40.64      | 43.18 |
| 18P      | 43.18      | 45.72 |
| 19P      | 45.72      | 48.26 |
| 20P      | 48.26      | 50.80 |
| 21P      | 50.80      | 53.34 |
| 22P      | 53.34      | 55.88 |
| 23P      | 55.88      | 58.42 |
| 24P      | 58.42      | 60.96 |
| 25P      | 60.96      | 63.50 |

Unit: mm

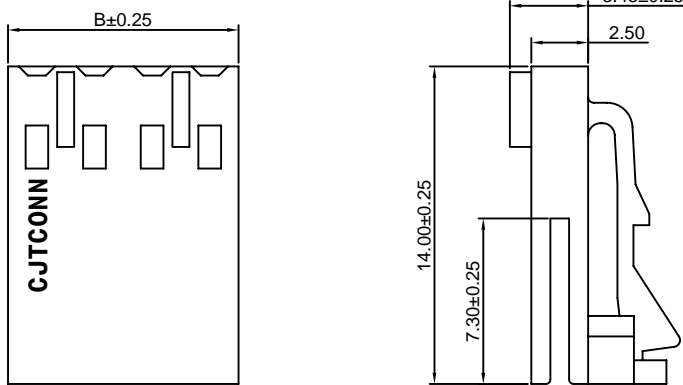

### A2550H-XP-A3H

2.54mm Pitch Crimp Flex Housing

**Reference Informations:**

- \*Material:PBT30%GF,UL94V-0
- \*Suitable CJT A2550 series Terminal (A2550-T(-H), A2550-T(-H)-CR, A2550-T-A, A2550-T-C)
- \*Mates with CJT A2550HM-XP, A2547HM-XP series Housing or A2547WVA,WRA-XP series Wafer
- \*Color:Black

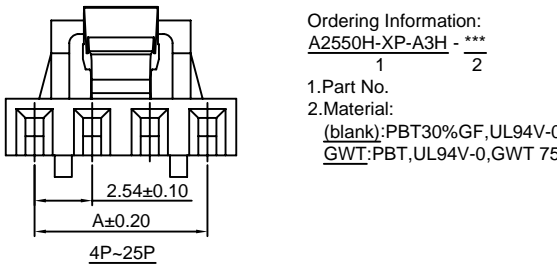

Ordering Information:  
A2550H-XP-A3H - \*\*\*  
 $\frac{1}{2}$   
 1.Part No.  
 2.Material:  
 (blank):PBT30%GF,UL94V-0  
 GWT:PBT,UL94V-0,GWT 750°C

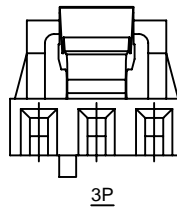

**Ordering Information & Dimensions:**

| PART NO. | Dimensions |       |
|----------|------------|-------|
|          | A          | B     |
| 3P       | 5.08       | 7.62  |
| 4P       | 7.62       | 10.16 |
| 5P       | 10.16      | 12.70 |
| 6P       | 12.70      | 15.24 |
| 7P       | 15.24      | 17.78 |
| 8P       | 17.78      | 20.32 |
| 9P       | 20.32      | 22.86 |
| 10P      | 22.86      | 25.40 |
| 11P      | 25.40      | 27.94 |
| 12P      | 27.94      | 30.48 |
| 13P      | 30.48      | 33.02 |
| 14P      | 33.02      | 35.56 |
| 15P      | 35.56      | 38.10 |
| 16P      | 38.10      | 40.64 |
| 17P      | 40.64      | 43.18 |
| 18P      | 43.18      | 45.72 |
| 19P      | 45.72      | 48.26 |
| 20P      | 48.26      | 50.80 |
| 21P      | 50.80      | 53.34 |
| 22P      | 53.34      | 55.88 |
| 23P      | 55.88      | 58.42 |
| 24P      | 58.42      | 60.96 |
| 25P      | 60.96      | 63.50 |

Unit: mm

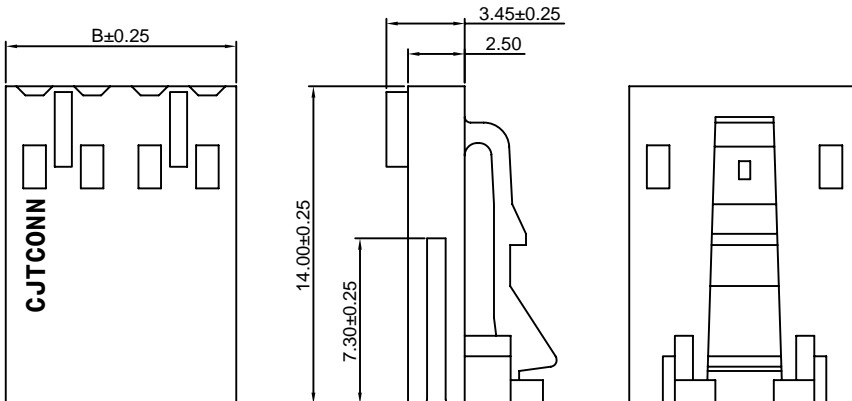

### A2550H-XP-B

2.54mm Pitch Crimp Flex Housing

**Reference Informations:**

- \*Material:PBT30%GF,UL94V-0
- \*Suitable CJT A2550 series Terminal (A2550-T(H), A2550-T(H)-CR, A2550-T-A, A2550-T-C)
- \*Mates with CJT A2547HMA-XP series Housing or A2547 series Wafer
- \*Color:Black

**Ordering Information:**

A2550H-XP-B - \*\*\*  
1 2

- 1.Part No.
- 2.Material:

(blank):PBT30%GF,UL94V-0  
GWT:PBT,UL94V-0,GWT 750 °C

**Ordering Information & Dimensions:**

| PART NO. | Dimensions |       |
|----------|------------|-------|
|          | A          | B     |
| 2P       | 2.54       | 5.08  |
| 3P       | 5.08       | 7.62  |
| 4P       | 7.62       | 10.16 |
| 5P       | 10.16      | 12.70 |
| 6P       | 12.70      | 15.24 |
| 7P       | 15.24      | 17.78 |
| 8P       | 17.78      | 20.32 |
| 9P       | 20.32      | 22.86 |
| 10P      | 22.86      | 25.40 |
| 11P      | 25.40      | 27.94 |
| 12P      | 27.94      | 30.48 |
| 13P      | 30.48      | 33.02 |
| 14P      | 33.02      | 35.56 |
| 15P      | 35.56      | 38.10 |
| 16P      | 38.10      | 40.64 |
| 17P      | 40.64      | 43.18 |
| 18P      | 43.18      | 45.72 |
| 19P      | 45.72      | 48.26 |
| 20P      | 48.26      | 50.80 |
| 21P      | 50.80      | 53.34 |
| 22P      | 53.34      | 55.88 |
| 23P      | 55.88      | 58.42 |
| 24P      | 58.42      | 60.96 |
| 25P      | 60.96      | 63.50 |

Unit: mm

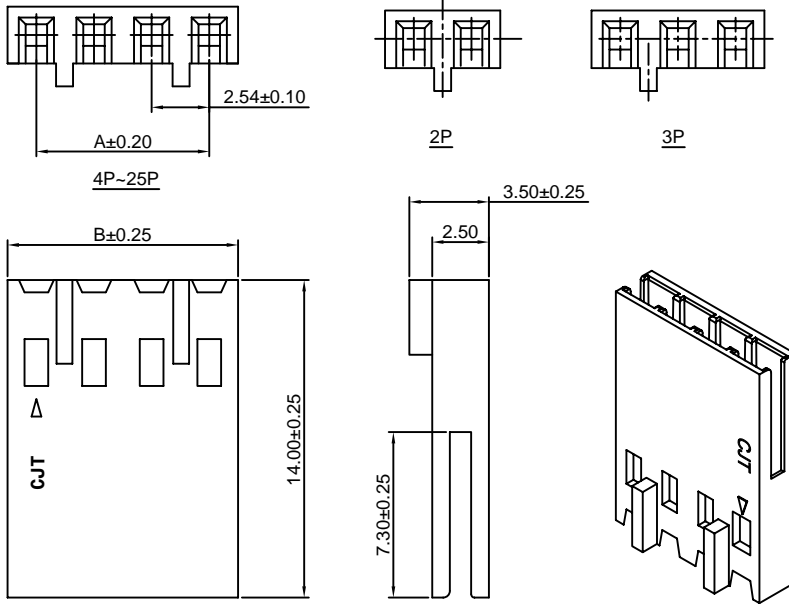

### A2550H-XP-BH

2.54mm Pitch Crimp Flex Housing

**Reference Informations:**

- \*Material:PBT30%GF,UL94V-0
- \*Suitable CJT A2550 series Terminal (A2550-T(H), A2550-T(H)-CR, A2550-T-A, A2550-T-C)
- \*Mates with CJT A2547HMA-XP series Housing or A2547 series Wafer
- \*Color:Black

**Ordering Information:**

A2550H-XP-BH - \*\*\*  
1 2

- 1.Part No.
- 2.Material:

(blank):PBT30%GF,UL94V-0  
GWT:PBT,UL94V-0,GWT 750 °C

**Ordering Information & Dimensions:**

| PART NO. | Dimensions |       |
|----------|------------|-------|
|          | A          | B     |
| 2P       | 2.54       | 5.08  |
| 3P       | 5.08       | 7.62  |
| 4P       | 7.62       | 10.16 |
| 5P       | 10.16      | 12.70 |
| 6P       | 12.70      | 15.24 |
| 7P       | 15.24      | 17.78 |
| 8P       | 17.78      | 20.32 |
| 9P       | 20.32      | 22.86 |
| 10P      | 22.86      | 25.40 |
| 11P      | 25.40      | 27.94 |
| 12P      | 27.94      | 30.48 |
| 13P      | 30.48      | 33.02 |
| 14P      | 33.02      | 35.56 |
| 15P      | 35.56      | 38.10 |
| 16P      | 38.10      | 40.64 |
| 17P      | 40.64      | 43.18 |
| 18P      | 43.18      | 45.72 |
| 19P      | 45.72      | 48.26 |
| 20P      | 48.26      | 50.80 |
| 21P      | 50.80      | 53.34 |
| 22P      | 53.34      | 55.88 |
| 23P      | 55.88      | 58.42 |
| 24P      | 58.42      | 60.96 |
| 25P      | 60.96      | 63.50 |

Unit: mm

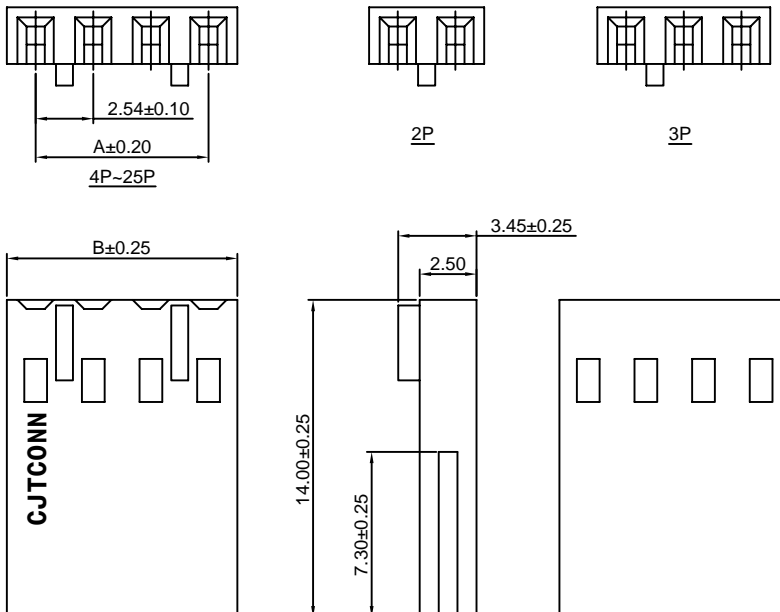

### A2550H-XP-C

2.54mm Pitch Crimp Flex Housing

**Reference Informations:**

- \*Material: PBT30%GF, UL94V-0
- \*Suitable CJT A2550 series Terminal (A2550-T(-H), A2550-T(-H)-CR, A2550-T-A, A2550-T-C)
- \*Mates with CJT A2547WVE, WRE-XP, A2549WV, WR-XP series Wafer
- \*Color: Black

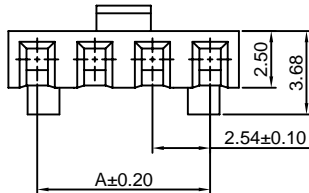

Ordering Information:  
A2550H-XP-C - \*\*\*  
 1 2  
 1. Part No.  
 2. Material:  
 (blank): PBT30%GF, UL94V-0  
 GWT: PBT, UL94V-0, GWT 750°C

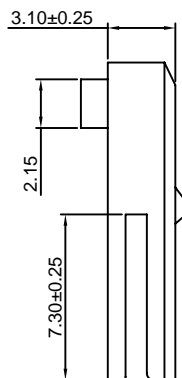

**Ordering Information & Dimensions:**

| PART NO. | Dimensions |       |
|----------|------------|-------|
|          | A          | B     |
| 2P       | 2.54       | 5.08  |
| 3P       | 5.08       | 7.62  |
| 4P       | 7.62       | 10.16 |
| 5P       | 10.16      | 12.70 |
| 6P       | 12.70      | 15.24 |
| 7P       | 15.24      | 17.78 |
| 8P       | 17.78      | 20.32 |
| 9P       | 20.32      | 22.86 |
| 10P      | 22.86      | 25.40 |
| 11P      | 25.40      | 27.94 |
| 12P      | 27.94      | 30.48 |
| 13P      | 30.48      | 33.02 |
| 14P      | 33.02      | 35.56 |
| 15P      | 35.56      | 38.10 |
| 16P      | 38.10      | 40.64 |
| 17P      | 40.64      | 43.18 |
| 18P      | 43.18      | 45.72 |
| 19P      | 45.72      | 48.26 |
| 20P      | 48.26      | 50.80 |
| 21P      | 50.80      | 53.34 |
| 22P      | 53.34      | 55.88 |
| 23P      | 55.88      | 58.42 |
| 24P      | 58.42      | 60.96 |
| 25P      | 60.96      | 63.50 |

Unit: mm

### A2550H-XP-C1

2.54mm Pitch Crimp Flex Housing

**Reference Informations:**

- \*Material: PBT30%GF, UL94V-0
- \*Suitable CJT A2550 series Terminal (A2550-T(-H), A2550-T(-H)-CR, A2550-T-A, A2550-T-C)
- \*Mates with CJT A2547WVE, WRE-XP, A2549WV, WR-XP series Wafer
- \*Color: Black

Ordering Information:  
A2550H-XP-C1 - \*\*\*  
 1 2  
 1. Part No.  
 2. Material:  
 (blank): PBT30%GF, UL94V-0  
 GWT: PBT, UL94V-0, GWT 750°C

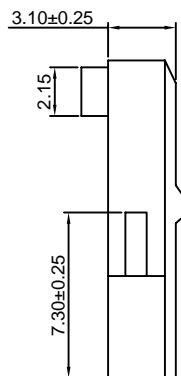

**Ordering Information & Dimensions:**

| PART NO. | Dimensions |       |       |
|----------|------------|-------|-------|
|          | A          | B     | C     |
| 2P       | 2.54       | 5.08  | 7.62  |
| 3P       | 5.08       | 7.62  | 10.16 |
| 4P       | 7.62       | 10.16 | 12.70 |
| 5P       | 10.16      | 12.70 | 15.24 |
| 6P       | 12.70      | 15.24 | 17.78 |
| 7P       | 15.24      | 17.78 | 20.32 |
| 8P       | 17.78      | 20.32 | 22.86 |
| 9P       | 20.32      | 22.86 | 25.40 |
| 10P      | 22.86      | 25.40 | 27.94 |
| 11P      | 25.40      | 27.94 | 30.48 |
| 12P      | 27.94      | 30.48 | 33.02 |
| 13P      | 30.48      | 33.02 | 35.56 |
| 14P      | 33.02      | 35.56 | 38.10 |
| 15P      | 35.56      | 38.10 | 40.64 |
| 16P      | 38.10      | 40.64 | 43.18 |
| 17P      | 40.64      | 43.18 | 45.72 |
| 18P      | 43.18      | 45.72 | 48.26 |
| 19P      | 45.72      | 48.26 | 50.80 |
| 20P      | 48.26      | 50.80 | 53.34 |
| 21P      | 50.80      | 53.34 | 55.88 |
| 22P      | 53.34      | 55.88 | 58.42 |
| 23P      | 55.88      | 58.42 | 60.96 |
| 24P      | 58.42      | 60.96 | 63.50 |
| 25P      | 60.96      | 63.50 | 66.04 |

Unit: mm



## A2550H-XP-G

2.54mm Pitch Crimp Flex Housing

**Reference Informations:**

- \*Material:PBT30%GF,UL94V-0
- \*Suitable CJT A2550 series Terminal (A2550-T-J)
- \*Mates with CJT A2541 series Wafer
- \*Color:Black

**Ordering Information:**

A2550H-XP-G - \*\*\*  
 1 2

1.Part No.

2.Material:

(blank):PBT30%GF,UL94V-0  
 GWT:PBT,UL94V-0,GWT 750°C

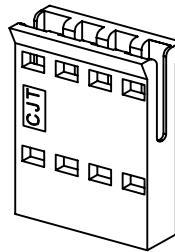
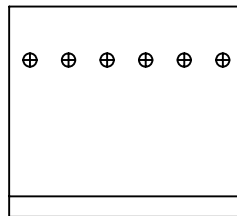
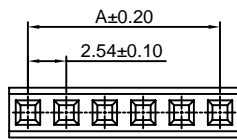
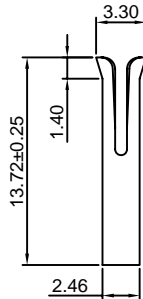
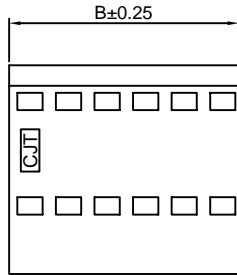

**Ordering Information & Dimensions:**

| PART NO. | Dimensions |       | PART NO. | Dimensions |       |
|----------|------------|-------|----------|------------|-------|
|          | A          | B     |          | A          | B     |
| 2P       | 2.54       | 4.92  | 19P      | 45.72      | 48.10 |
| 3P       | 5.08       | 7.46  | 20P      | 48.26      | 50.64 |
| 4P       | 7.62       | 10.00 | 21P      | 50.80      | 53.18 |
| 5P       | 10.16      | 12.54 | 22P      | 53.34      | 55.72 |
| 6P       | 12.70      | 15.08 | 23P      | 55.88      | 58.26 |
| 7P       | 15.24      | 17.62 | 24P      | 58.42      | 60.80 |
| 8P       | 17.78      | 20.16 | 25P      | 60.96      | 63.34 |
| 9P       | 20.32      | 22.70 | 26P      | 63.50      | 65.88 |
| 10P      | 22.86      | 25.24 | 27P      | 66.04      | 68.42 |
| 11P      | 25.40      | 27.78 | 28P      | 68.58      | 70.96 |
| 12P      | 27.94      | 30.32 | 29P      | 71.12      | 73.50 |
| 13P      | 30.48      | 32.86 | 30P      | 73.66      | 76.04 |
| 14P      | 33.02      | 35.40 | 31P      | 76.20      | 78.58 |
| 15P      | 35.56      | 37.94 | 32P      | 78.74      | 81.12 |
| 16P      | 38.10      | 40.48 | 33P      | 81.28      | 83.66 |
| 17P      | 40.64      | 43.02 | 34P      | 83.82      | 86.20 |
| 18P      | 43.18      | 45.56 |          |            |       |

Unit: mm

## A2550H-XP-G1

2.54mm Pitch Crimp Flex Housing

**Reference Informations:**

- \*Material:PBT30%GF,UL94V-0
- \*Suitable CJT A2550 series Terminal (A2550-T-J)
- \*Mates with CJT A2541 series Wafer
- \*Color:Black

**Ordering Information:**

A2550H-XP-G1 - \*\*\*  
 1 2

1.Part No.

2.Material:

(blank):PBT30%GF,UL94V-0  
 GWT:PBT,UL94V-0,GWT 750°C

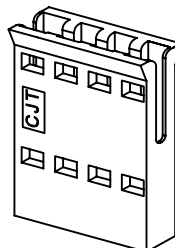
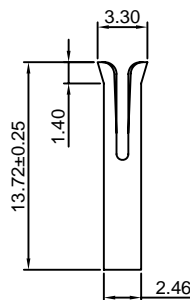

**Ordering Information & Dimensions:**

| PART NO. | Dimensions |       | PART NO. | Dimensions |       |
|----------|------------|-------|----------|------------|-------|
|          | A          | B     |          | A          | B     |
| 2P       | 2.54       | 4.92  | 19P      | 45.72      | 48.10 |
| 3P       | 5.08       | 7.46  | 20P      | 48.26      | 50.64 |
| 4P       | 7.62       | 10.00 | 21P      | 50.80      | 53.18 |
| 5P       | 10.16      | 12.54 | 22P      | 53.34      | 55.72 |
| 6P       | 12.70      | 15.08 | 23P      | 55.88      | 58.26 |
| 7P       | 15.24      | 17.62 | 24P      | 58.42      | 60.80 |
| 8P       | 17.78      | 20.16 | 25P      | 60.96      | 63.34 |
| 9P       | 20.32      | 22.70 | 26P      | 63.50      | 65.88 |
| 10P      | 22.86      | 25.24 | 27P      | 66.04      | 68.42 |
| 11P      | 25.40      | 27.78 | 28P      | 68.58      | 70.96 |
| 12P      | 27.94      | 30.32 | 29P      | 71.12      | 73.50 |
| 13P      | 30.48      | 32.86 | 30P      | 73.66      | 76.04 |
| 14P      | 33.02      | 35.40 | 31P      | 76.20      | 78.58 |
| 15P      | 35.56      | 37.94 | 32P      | 78.74      | 81.12 |
| 16P      | 38.10      | 40.48 | 33P      | 81.28      | 83.66 |
| 17P      | 40.64      | 43.02 | 34P      | 83.82      | 86.20 |
| 18P      | 43.18      | 45.56 |          |            |       |

Unit: mm

### A2550H-XP-H

2.54mm Pitch Crimp Flex Housing

**Reference Informations:**

- \*Material:PBT30%GF,UL94V-0
- \*Suitable CJT A2550 series Terminal (A2550-T-J)
- \*Mates with CJT A2547 series Wafer
- \*Color:Black

**Ordering Information:**

- A2550H-XP-H - \*\*\*  
 $\frac{1}{2}$
- 1.Part No.
  - 2.Material:  
 (blank):PBT30%GF,UL94V-0  
 GWT:PBT,UL94V-0,GWT 750°C

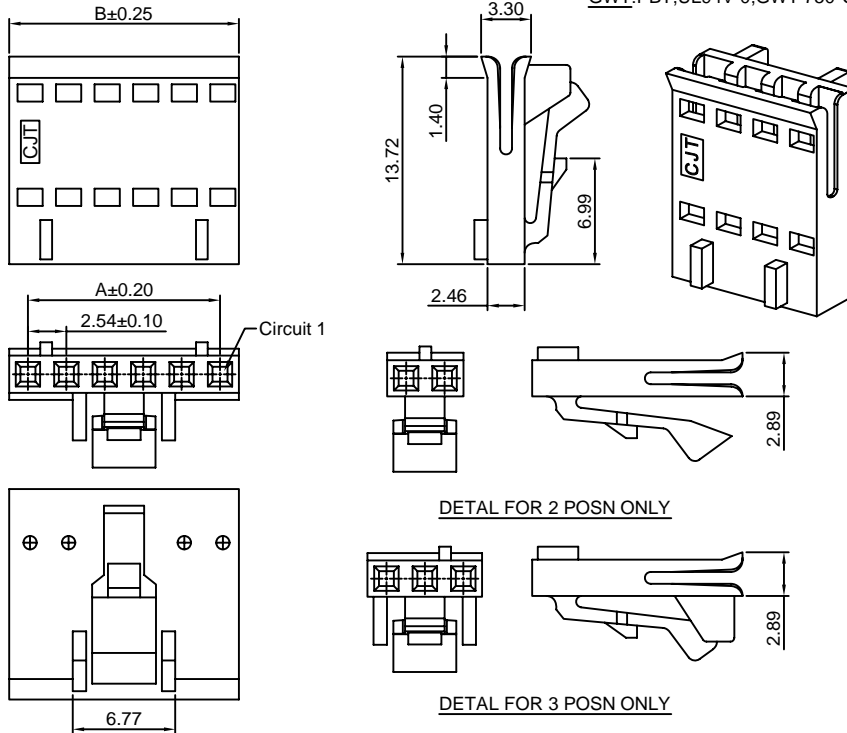

**Ordering Information & Dimensions:**

| PART NO. | Dimensions |       |
|----------|------------|-------|
|          | A          | B     |
| 2P       | 2.54       | 4.92  |
| 3P       | 5.08       | 7.46  |
| 4P       | 7.62       | 10.00 |
| 5P       | 10.16      | 12.54 |
| 6P       | 12.70      | 15.08 |
| 7P       | 15.24      | 17.62 |
| 8P       | 17.78      | 20.16 |
| 9P       | 20.32      | 22.70 |
| 10P      | 22.86      | 25.24 |
| 11P      | 25.40      | 27.78 |
| 12P      | 27.94      | 30.32 |
| 13P      | 30.48      | 32.86 |
| 14P      | 33.02      | 35.40 |
| 15P      | 35.56      | 37.94 |
| 16P      | 38.10      | 40.48 |
| 17P      | 40.64      | 43.02 |
| 18P      | 43.18      | 45.56 |
| 19P      | 45.72      | 48.10 |
| 20P      | 48.26      | 50.64 |
| 21P      | 50.80      | 53.18 |
| 22P      | 53.34      | 55.72 |
| 23P      | 55.88      | 58.26 |
| 24P      | 58.42      | 60.80 |
| 25P      | 60.96      | 63.34 |

Unit: mm

### A2550H-XP-H1

2.54mm Pitch Crimp Flex Housing

**Reference Informations:**

- \*Material:PBT30%GF,UL94V-0
- \*Suitable CJT A2550 series Terminal (A2550-T-J)
- \*Mates with CJT A2547 series Wafer
- \*Color:Black

**Ordering Information:**

- A2550H-XP-H1 - \*\*\*  
 $\frac{1}{2}$
- 1.Part No.
  - 2.Material:  
 (blank):PBT30%GF,UL94V-0  
 GWT:PBT,UL94V-0,GWT 750°C

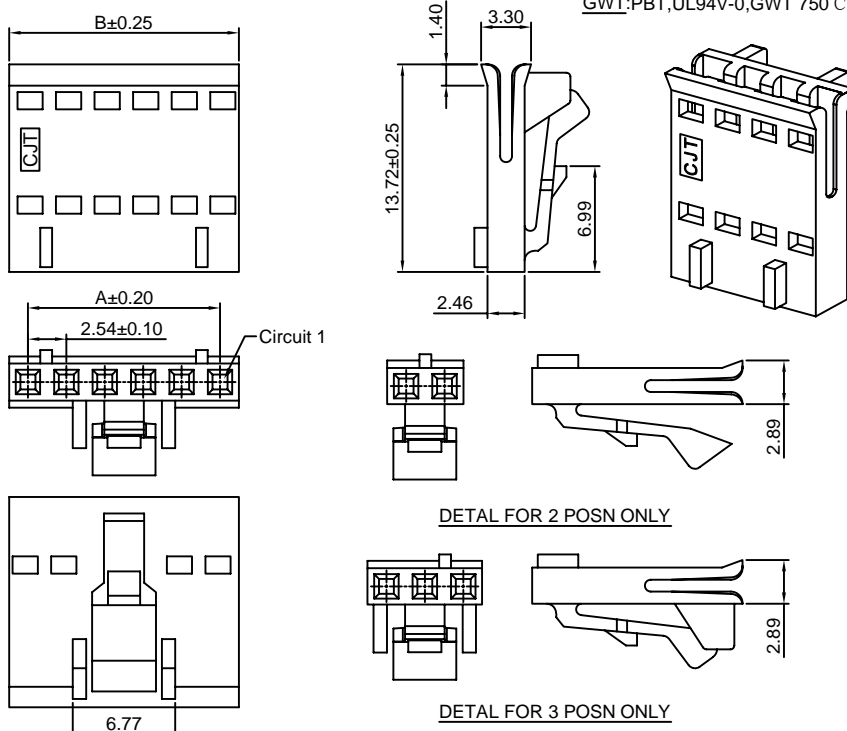

**Ordering Information & Dimensions:**

| PART NO. | Dimensions |       |
|----------|------------|-------|
|          | A          | B     |
| 2P       | 2.54       | 4.92  |
| 3P       | 5.08       | 7.46  |
| 4P       | 7.62       | 10.00 |
| 5P       | 10.16      | 12.54 |
| 6P       | 12.70      | 15.08 |
| 7P       | 15.24      | 17.62 |
| 8P       | 17.78      | 20.16 |
| 9P       | 20.32      | 22.70 |
| 10P      | 22.86      | 25.24 |
| 11P      | 25.40      | 27.78 |
| 12P      | 27.94      | 30.32 |
| 13P      | 30.48      | 32.86 |
| 14P      | 33.02      | 35.40 |
| 15P      | 35.56      | 37.94 |
| 16P      | 38.10      | 40.48 |
| 17P      | 40.64      | 43.02 |
| 18P      | 43.18      | 45.56 |
| 19P      | 45.72      | 48.10 |
| 20P      | 48.26      | 50.64 |
| 21P      | 50.80      | 53.18 |
| 22P      | 53.34      | 55.72 |
| 23P      | 55.88      | 58.26 |
| 24P      | 58.42      | 60.80 |
| 25P      | 60.96      | 63.34 |

Unit: mm

### A2550H-XP-H2

2.54mm Pitch Crimp Flex Housing

**Reference Informations:**

- \*Material:PBT30%GF,UL94V-0
- \*Suitable CJT A2550 series Terminal (A2550-T-J)
- \*Mates with CJT A2547 series Wafer
- \*Color:Black

**Ordering Information:**

- A2550H-XP-H2 - \*\*\*  
 $\frac{1}{2}$
- 1.Part No.  
 2.Material:  
 (blank):PBT30%GF,UL94V-0  
 GWT:PBT,UL94V-0,GWT 750°C

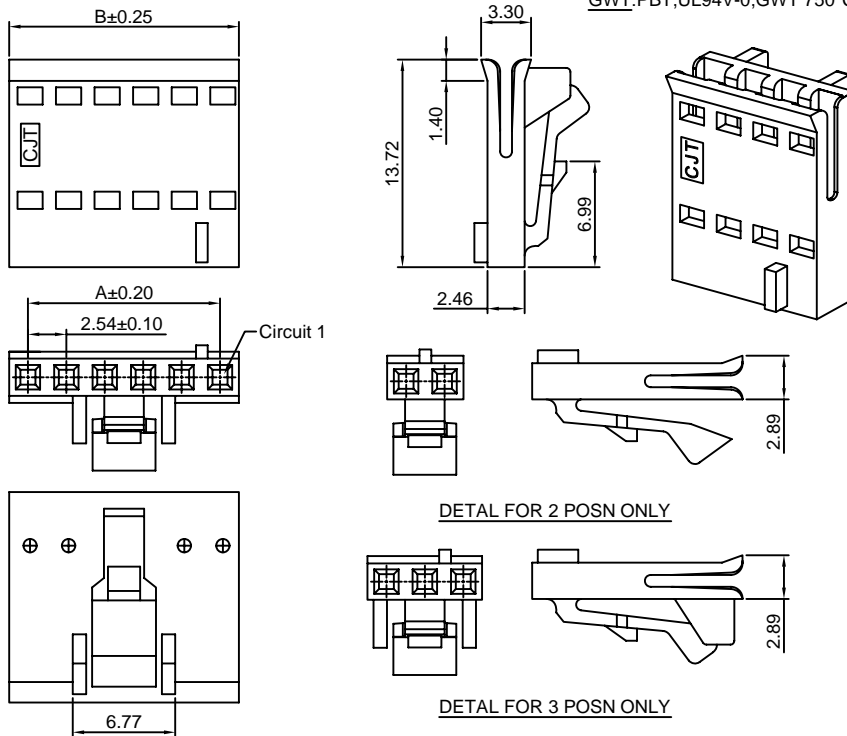

**Ordering Information & Dimensions:**

| PART NO. | Dimensions |       |
|----------|------------|-------|
|          | A          | B     |
| 2P       | 2.54       | 4.92  |
| 3P       | 5.08       | 7.46  |
| 4P       | 7.62       | 10.00 |
| 5P       | 10.16      | 12.54 |
| 6P       | 12.70      | 15.08 |
| 7P       | 15.24      | 17.62 |
| 8P       | 17.78      | 20.16 |
| 9P       | 20.32      | 22.70 |
| 10P      | 22.86      | 25.24 |
| 11P      | 25.40      | 27.78 |
| 12P      | 27.94      | 30.32 |
| 13P      | 30.48      | 32.86 |
| 14P      | 33.02      | 35.40 |
| 15P      | 35.56      | 37.94 |
| 16P      | 38.10      | 40.48 |
| 17P      | 40.64      | 43.02 |
| 18P      | 43.18      | 45.56 |
| 19P      | 45.72      | 48.10 |
| 20P      | 48.26      | 50.64 |
| 21P      | 50.80      | 53.18 |
| 22P      | 53.34      | 55.72 |
| 23P      | 55.88      | 58.26 |
| 24P      | 58.42      | 60.80 |
| 25P      | 60.96      | 63.34 |

Unit: mm

### A2550H-XP-I

2.54mm Pitch Crimp Flex Housing

**Reference Informations:**

- \*Material:PBT30%GF,UL94V-0
- \*Suitable CJT A2550 series Terminal (A2550-T-J)
- \*Mates with CJT A2549 series Wafer or A2547WVE,WRE-XP series Wafer
- \*Color:Black

**Ordering Information:**

- A2550H-XP-I - \*\*\*  
 $\frac{1}{2}$
- 1.Part No.  
 2.Material:  
 (blank):PBT30%GF,UL94V-0  
 GWT:PBT,UL94V-0,GWT 750°C

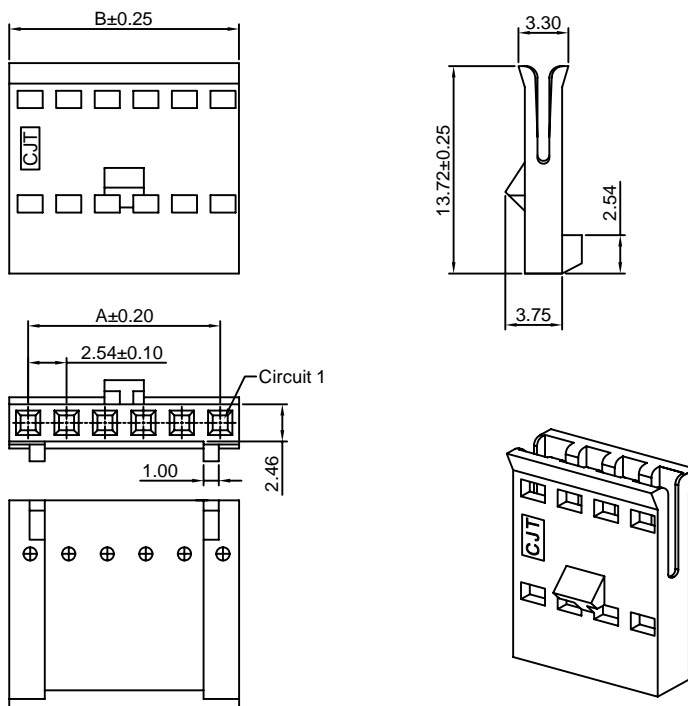

**Ordering Information & Dimensions:**

| PART NO. | Dimensions |       |
|----------|------------|-------|
|          | A          | B     |
| 2P       | 2.54       | 4.92  |
| 3P       | 5.08       | 7.46  |
| 4P       | 7.62       | 10.00 |
| 5P       | 10.16      | 12.54 |
| 6P       | 12.70      | 15.08 |
| 7P       | 15.24      | 17.62 |
| 8P       | 17.78      | 20.16 |
| 9P       | 20.32      | 22.70 |
| 10P      | 22.86      | 25.24 |
| 11P      | 25.40      | 27.78 |
| 12P      | 27.94      | 30.32 |
| 13P      | 30.48      | 32.86 |
| 14P      | 33.02      | 35.40 |
| 15P      | 35.56      | 37.94 |
| 16P      | 38.10      | 40.48 |
| 17P      | 40.64      | 43.02 |
| 18P      | 43.18      | 45.56 |
| 19P      | 45.72      | 48.10 |
| 20P      | 48.26      | 50.64 |
| 21P      | 50.80      | 53.18 |
| 22P      | 53.34      | 55.72 |
| 23P      | 55.88      | 58.26 |
| 24P      | 58.42      | 60.80 |
| 25P      | 60.96      | 63.34 |

Unit: mm



### A2550H-XP-I1

2.54mm Pitch Crimp Flex Housing

**Reference Informations:**

- \*Material: PBT30%GF, UL94V-0
- \*Suitable CJT A2550 series Terminal (A2550-T-J)
- \*Mates with CJT A2549 series Wafer or A2547WVE, WRE-XP series Wafer
- \*Color: Black

**Ordering Information:**

- A2550H-XP-I1 - \*\*\*
- |   |   |
|---|---|
| 1 | 2 |
|---|---|
1. Part No.  
2. Material:  
(blank): PBT30%GF, UL94V-0  
GWT: PBT, UL94V-0, GWT 750°C

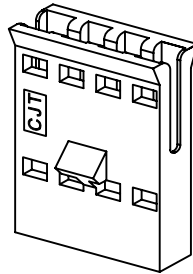
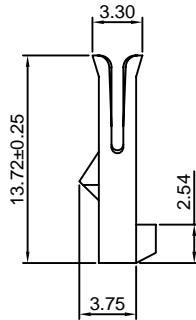
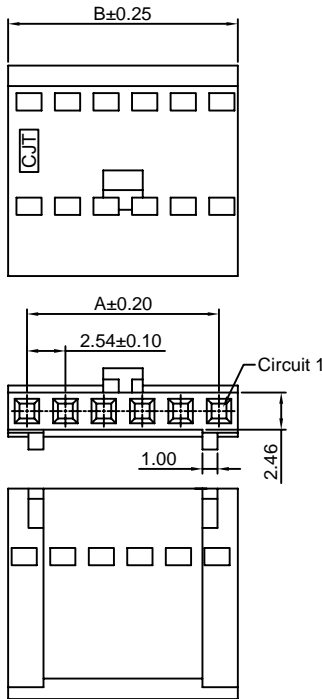

**Ordering Information & Dimensions:**

| PART NO. | Dimensions |       |
|----------|------------|-------|
|          | A          | B     |
| 2P       | 2.54       | 4.92  |
| 3P       | 5.08       | 7.46  |
| 4P       | 7.62       | 10.00 |
| 5P       | 10.16      | 12.54 |
| 6P       | 12.70      | 15.08 |
| 7P       | 15.24      | 17.62 |
| 8P       | 17.78      | 20.16 |
| 9P       | 20.32      | 22.70 |
| 10P      | 22.86      | 25.24 |
| 11P      | 25.40      | 27.78 |
| 12P      | 27.94      | 30.32 |
| 13P      | 30.48      | 32.86 |
| 14P      | 33.02      | 35.40 |
| 15P      | 35.56      | 37.94 |
| 16P      | 38.10      | 40.48 |
| 17P      | 40.64      | 43.02 |
| 18P      | 43.18      | 45.56 |
| 19P      | 45.72      | 48.10 |
| 20P      | 48.26      | 50.64 |
| 21P      | 50.80      | 53.18 |
| 22P      | 53.34      | 55.72 |
| 23P      | 55.88      | 58.26 |
| 24P      | 58.42      | 60.80 |
| 25P      | 60.96      | 63.34 |

Unit: mm

### A2550H-XP-J

2.54mm Pitch Crimp Flex Housing

**Reference Informations:**

- \*Material: PBT30%GF, UL94V-0
- \*Suitable CJT A2550 series Terminal (A2550-T(-H), A2550-T(-H)-CR, A2550-T-A, A2550-T-C, A2550M-T)
- \*Mates with CJT A2541 series Wafer
- \*Color: Black

**Ordering Information:**

- A2550H-XP-J - \*\*\*
- |   |   |
|---|---|
| 1 | 2 |
|---|---|
1. Part No.  
2. Material:  
(blank): PBT30%GF, UL94V-0  
GWT: PBT, UL94V-0, GWT 750°C

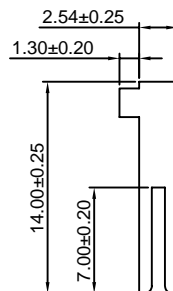
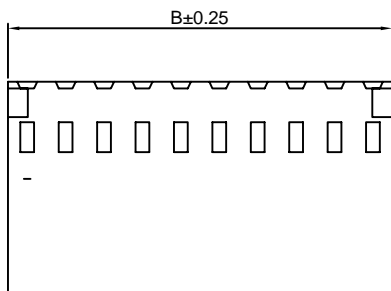
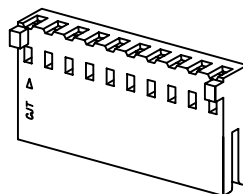
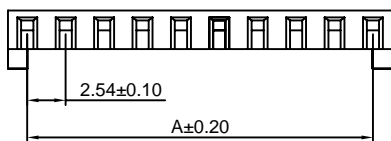

**Ordering Information & Dimensions:**

| PART NO. | Dimensions |       |
|----------|------------|-------|
|          | A          | B     |
| 2P       | 2.54       | 5.08  |
| 3P       | 5.08       | 7.62  |
| 4P       | 7.62       | 10.16 |
| 5P       | 10.16      | 12.70 |
| 6P       | 12.70      | 15.24 |
| 7P       | 15.24      | 17.78 |
| 8P       | 17.78      | 20.32 |
| 9P       | 20.32      | 22.86 |
| 10P      | 22.86      | 25.40 |
| 11P      | 25.40      | 27.94 |
| 12P      | 27.94      | 30.48 |
| 13P      | 30.48      | 33.02 |
| 14P      | 33.02      | 35.56 |
| 15P      | 35.56      | 38.10 |
| 16P      | 38.10      | 40.64 |
| 17P      | 40.64      | 43.18 |
| 18P      | 43.18      | 45.72 |
| 19P      | 45.72      | 48.26 |
| 20P      | 48.26      | 50.80 |
| 21P      | 50.80      | 53.34 |
| 22P      | 53.34      | 55.88 |
| 23P      | 55.88      | 58.42 |
| 24P      | 58.42      | 60.96 |
| 25P      | 60.96      | 63.50 |

Unit: mm

### A2550HD-XP

2.54mm Pitch Crimp Flex Housing

**Reference Informations:**

- \*Material:Nylon 66,UL94V-0
- \*Terminal Material:Phosphor Bronze/Tin over Nickel
- \*Mates with CJT A2541 series Wafer
- \*Used in FFC Wire
- \*Color:Blue

**Ordering Information:**

- A2550HD-XP - \*\*\* - \*  
 1 2 3
- 1.Part No.
  - 2.Material:  
 (blank):Nylon 66,UL94V-0  
 GWT:Nylon 66,UL94V-0,GWT 750℃
  - 3.Finish:  
 (blank):Tin over Nickel  
 G:Gold over Nickel

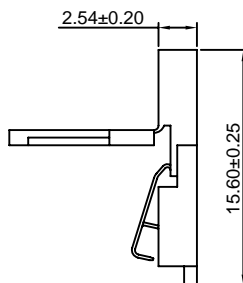
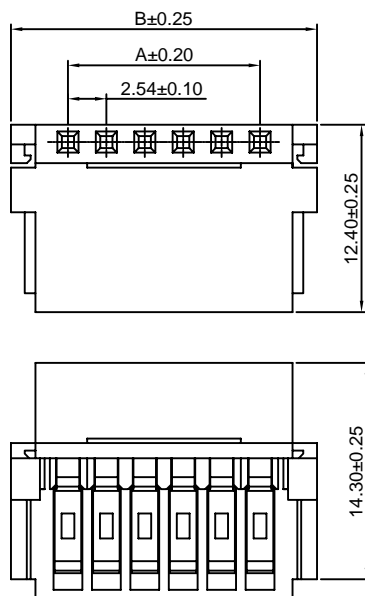
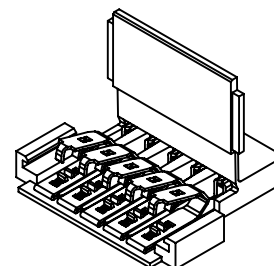

**Ordering Information & Dimensions:**

| PART NO. | Dimensions |       | PART NO. | Dimensions |       |
|----------|------------|-------|----------|------------|-------|
|          | A          | B     |          | A          | B     |
| 2P       | 2.54       | 10.08 | 20P      | 48.26      | 55.80 |
| 3P       | 5.08       | 12.62 | 21P      | 50.80      | 58.34 |
| 4P       | 7.62       | 15.16 | 22P      | 53.34      | 60.88 |
| 5P       | 10.16      | 17.70 | 23P      | 55.88      | 63.42 |
| 6P       | 12.70      | 20.24 | 24P      | 58.42      | 65.96 |
| 7P       | 15.24      | 22.78 | 25P      | 60.96      | 68.50 |
| 8P       | 17.78      | 25.32 | 26P      | 63.50      | 71.04 |
| 9P       | 20.32      | 27.86 | 27P      | 66.04      | 73.58 |
| 10P      | 22.86      | 30.40 | 28P      | 68.58      | 76.12 |
| 11P      | 25.40      | 32.94 | 29P      | 71.12      | 78.66 |
| 12P      | 27.94      | 35.48 | 30P      | 73.66      | 81.20 |
| 13P      | 30.48      | 38.02 | 31P      | 76.20      | 83.74 |
| 14P      | 33.02      | 40.56 | 32P      | 78.74      | 86.28 |
| 15P      | 35.56      | 43.10 | 33P      | 81.28      | 88.82 |
| 16P      | 38.10      | 45.64 | 34P      | 83.82      | 91.36 |
| 17P      | 40.64      | 48.18 | 35P      | 86.36      | 93.90 |
| 18P      | 43.18      | 50.72 | 36P      | 88.90      | 96.44 |
| 19P      | 45.72      | 53.26 |          |            |       |

Unit: mm

### A2550HDM-XP

2.54mm Pitch Crimp Flex Housing

**Reference Informations:**

- \*Material:Nylon 66,UL94V-0
- \*Terminal Material:Phosphor Bronze/Tin over Nickel
- \*Used in FFC Wire
- \*Color:Blue

**Ordering Information:**

- A2550HDM-XP - \*\*\* - \*  
 1 2 3
- 1.Part No.
  - 2.Material:  
 (blank):Nylon 66,UL94V-0  
 GWT:Nylon 66,UL94V-0,GWT 750℃
  - 3.Finish:  
 (blank):Tin over Nickel  
 G:Gold over Nickel

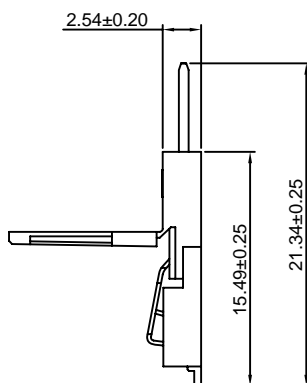
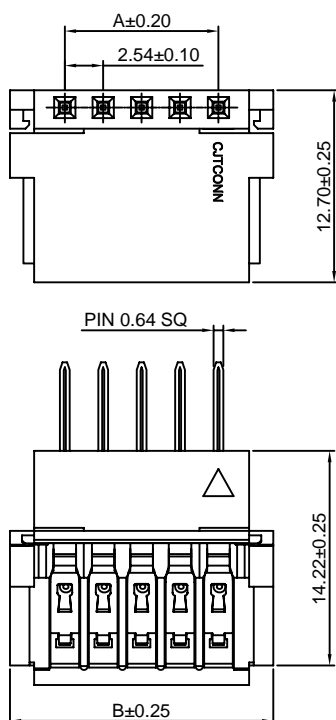

**Ordering Information & Dimensions:**

| PART NO. | Dimensions |       | PART NO. | Dimensions |       |
|----------|------------|-------|----------|------------|-------|
|          | A          | B     |          | A          | B     |
| 2P       | 2.54       | 9.91  | 20P      | 48.26      | 55.63 |
| 3P       | 5.08       | 12.45 | 21P      | 50.80      | 58.17 |
| 4P       | 7.62       | 14.99 | 22P      | 53.34      | 60.71 |
| 5P       | 10.16      | 17.53 | 23P      | 55.88      | 63.25 |
| 6P       | 12.70      | 20.07 | 24P      | 58.42      | 65.79 |
| 7P       | 15.24      | 22.61 | 25P      | 60.96      | 68.33 |
| 8P       | 17.78      | 25.15 | 26P      | 63.50      | 70.87 |
| 9P       | 20.32      | 27.69 | 27P      | 66.04      | 73.41 |
| 10P      | 22.86      | 30.23 | 28P      | 68.58      | 75.95 |
| 11P      | 25.40      | 32.77 | 29P      | 71.12      | 78.49 |
| 12P      | 27.94      | 35.31 | 30P      | 73.66      | 81.03 |
| 13P      | 30.48      | 37.85 | 31P      | 76.20      | 83.57 |
| 14P      | 33.02      | 40.39 | 32P      | 78.74      | 86.11 |
| 15P      | 35.56      | 42.93 | 33P      | 81.28      | 88.65 |
| 16P      | 38.10      | 45.47 | 34P      | 83.82      | 91.19 |
| 17P      | 40.64      | 48.01 | 35P      | 86.36      | 93.73 |
| 18P      | 43.18      | 50.55 | 36P      | 88.90      | 96.27 |
| 19P      | 45.72      | 53.09 |          |            |       |

Unit: mm

### A2550HE-XP

2.54mm Pitch Crimp Flex Housing

#### Reference Informations:

- \*Material:Nylon 66,UL94V-0
- \*Terminal Material:Phosphor Bronze/Tin over Nickel
- \*Mates with CJT A2541WV,WR-XP, A2549WVB,WRB-XP series Wafer
- \*Used in FFC Wire
- \*Color:Blue

#### Ordering Information:

A2550HE-XP - \*\*\* - \*  
 1            2    3

- 1.Part No.
- 2.Material:  
 (blank):Nylon 66,UL94V-0  
 GWT:Nylon 66,UL94V-0,GWT 750°C
- 3.Finish:  
 (blank):Tin over Nickel  
 G:Gold over Nickel

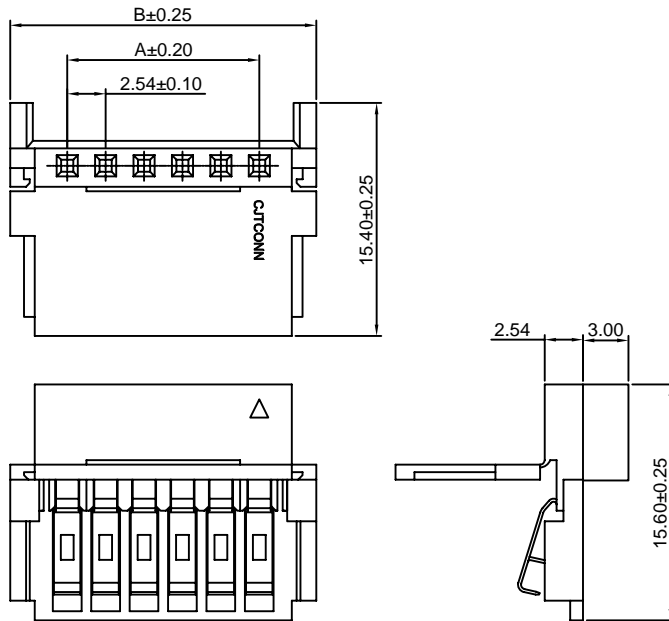

#### Ordering Information & Dimensions:

| PART NO. | Dimensions |       | PART NO. | Dimensions |       |
|----------|------------|-------|----------|------------|-------|
|          | A          | B     |          | A          | B     |
| 2P       | 2.54       | 10.08 | 19P      | 45.72      | 53.26 |
| 3P       | 5.08       | 12.62 | 20P      | 48.26      | 55.80 |
| 4P       | 7.62       | 15.16 | 21P      | 50.80      | 58.34 |
| 5P       | 10.16      | 17.70 | 22P      | 53.34      | 60.88 |
| 6P       | 12.70      | 20.24 | 23P      | 55.88      | 63.42 |
| 7P       | 15.24      | 22.78 | 24P      | 58.42      | 65.96 |
| 8P       | 17.78      | 25.32 | 25P      | 60.96      | 68.50 |
| 9P       | 20.32      | 27.86 | 26P      | 63.50      | 71.04 |
| 10P      | 22.86      | 30.40 | 27P      | 66.04      | 73.58 |
| 11P      | 25.40      | 32.94 | 28P      | 68.58      | 76.12 |
| 12P      | 27.94      | 35.48 | 29P      | 71.12      | 78.66 |
| 13P      | 30.48      | 38.02 | 30P      | 73.66      | 81.20 |
| 14P      | 33.02      | 40.56 | 31P      | 76.20      | 83.74 |
| 15P      | 35.56      | 43.10 | 32P      | 78.74      | 86.28 |
| 16P      | 38.10      | 45.64 | 33P      | 81.28      | 88.82 |
| 17P      | 40.64      | 48.18 | 34P      | 83.82      | 91.36 |
| 18P      | 43.18      | 50.72 |          |            |       |

Unit: mm

### A2550HF-XP

2.54mm Pitch Crimp Flex Housing

#### Reference Informations:

- \*Material:Nylon 66,UL94V-0
- \*Terminal Material:Phosphor Bronze/Tin over Nickel
- \*Mates with CJT A2547HM-XP, A2550HM-XP series Housing or A2547WVA,WRA-XP series Wafer
- \*Used in FFC Wire
- \*Color:Blue

#### Ordering Information:

A2550HF-XP - \*\*\* - \*  
 1            2    3

- 1.Part No.
- 2.Material:  
 (blank):Nylon 66,UL94V-0  
 GWT:Nylon 66,UL94V-0,GWT 750°C
- 3.Finish:  
 (blank):Tin over Nickel  
 G:Gold over Nickel

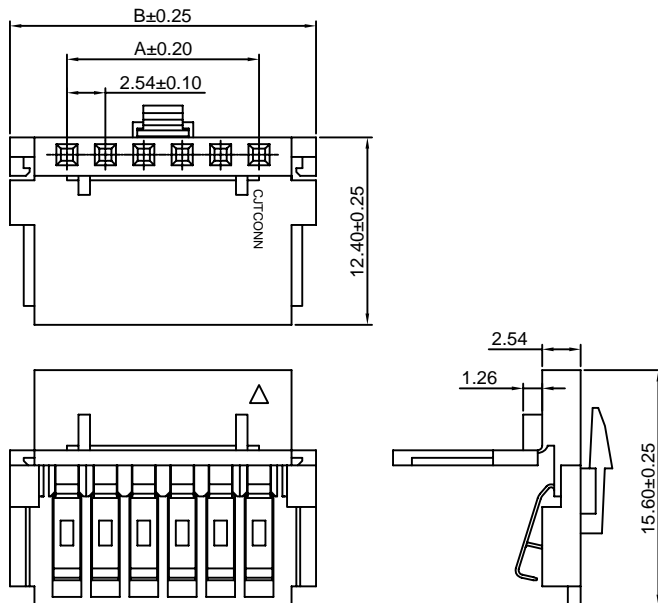

#### Ordering Information & Dimensions:

| PART NO. | Dimensions |       | PART NO. | Dimensions |       |
|----------|------------|-------|----------|------------|-------|
|          | A          | B     |          | A          | B     |
| 6P       | 12.70      | 20.24 | 21P      | 50.80      | 58.34 |
| 7P       | 15.24      | 22.78 | 22P      | 53.34      | 60.88 |
| 8P       | 17.78      | 25.32 | 23P      | 55.88      | 63.42 |
| 9P       | 20.32      | 27.86 | 24P      | 58.42      | 65.96 |
| 10P      | 22.86      | 30.40 | 25P      | 60.96      | 68.50 |
| 11P      | 25.40      | 32.94 | 26P      | 63.50      | 71.04 |
| 12P      | 27.94      | 35.48 | 27P      | 66.04      | 73.58 |
| 13P      | 30.48      | 38.02 | 28P      | 68.58      | 76.12 |
| 14P      | 33.02      | 40.56 | 29P      | 71.12      | 78.66 |
| 15P      | 35.56      | 43.10 | 30P      | 73.66      | 81.20 |
| 16P      | 38.10      | 45.64 | 31P      | 76.20      | 83.74 |
| 17P      | 40.64      | 48.18 | 32P      | 78.74      | 86.28 |
| 18P      | 43.18      | 50.72 | 33P      | 81.28      | 88.82 |
| 19P      | 45.72      | 53.26 | 34P      | 83.82      | 91.36 |
| 20P      | 48.26      | 55.80 |          |            |       |

Unit: mm

### A2550HG-XP

2.54mm Pitch Crimp Flex Housing

**Reference Informations:**

- \*Material: Nylon 66, UL94V-0
- \*Terminal Material: Phosphor Bronze/Tin over Nickel
- \*Mates with CJT A2547HM-XP, A2550HM, HMA-XP series Housing or A2547WVA, WRA-XP series Wafer
- \*Used in FFC Wire
- \*Color: Blue

**Ordering Information:**

A2550HG-XP - \*\*\* - \*  
 $\frac{1}{2} \frac{3}{}$

1. Part No.
2. Material:  
 (blank): Nylon 66, UL94V-0  
 GWT: Nylon 66, UL94V-0, GWT 750 °C
3. Finish:  
 (blank): Tin over Nickel  
 G: Gold over Nickel

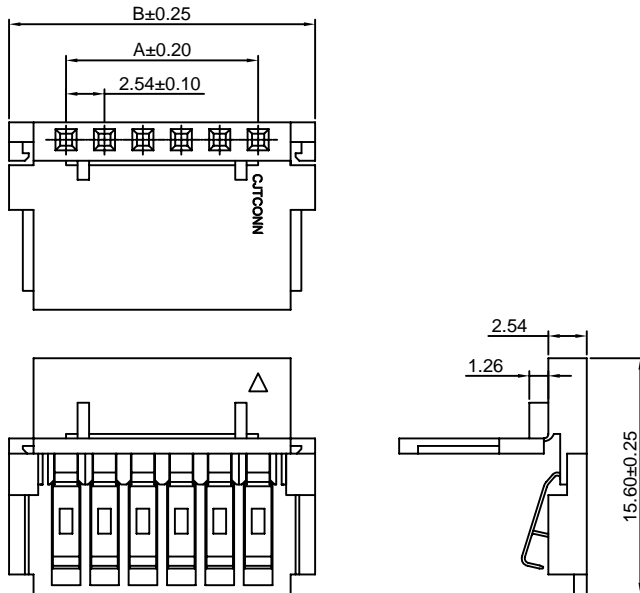

**Ordering Information & Dimensions:**

| PART NO. | Dimensions |       | PART NO. | Dimensions |       |
|----------|------------|-------|----------|------------|-------|
|          | A          | B     |          | A          | B     |
| 6P       | 12.70      | 20.24 | 21P      | 50.80      | 58.34 |
| 7P       | 15.24      | 22.78 | 22P      | 53.34      | 60.88 |
| 8P       | 17.78      | 25.32 | 23P      | 55.88      | 63.42 |
| 9P       | 20.32      | 27.86 | 24P      | 58.42      | 65.96 |
| 10P      | 22.86      | 30.40 | 25P      | 60.96      | 68.50 |
| 11P      | 25.40      | 32.94 | 26P      | 63.50      | 71.04 |
| 12P      | 27.94      | 35.48 | 27P      | 66.04      | 73.58 |
| 13P      | 30.48      | 38.02 | 28P      | 68.58      | 76.12 |
| 14P      | 33.02      | 40.56 | 29P      | 71.12      | 78.66 |
| 15P      | 35.56      | 43.10 | 30P      | 73.66      | 81.20 |
| 16P      | 38.10      | 45.64 | 31P      | 76.20      | 83.74 |
| 17P      | 40.64      | 48.18 | 32P      | 78.74      | 86.28 |
| 18P      | 43.18      | 50.72 | 33P      | 81.28      | 88.82 |
| 19P      | 45.72      | 53.26 | 34P      | 83.82      | 91.36 |
| 20P      | 48.26      | 55.80 |          |            |       |

Unit: mm

### A2550HK-XP

2.54mm Pitch Crimp Flex Housing

**Reference Informations:**

- \*Material: PBT30%GF, UL94V-0
- \*Suitable CJT A2550 series Terminal (A2550-T-K)
- \*Color: Blue

**Ordering Information:**

A2550HK-XP - \*\*\*  
 $\frac{1}{2}$

1. Part No.
2. Material:  
 (blank): PBT30%GF, UL94V-0  
 GWT: PBT, UL94V-0, GWT 750 °C

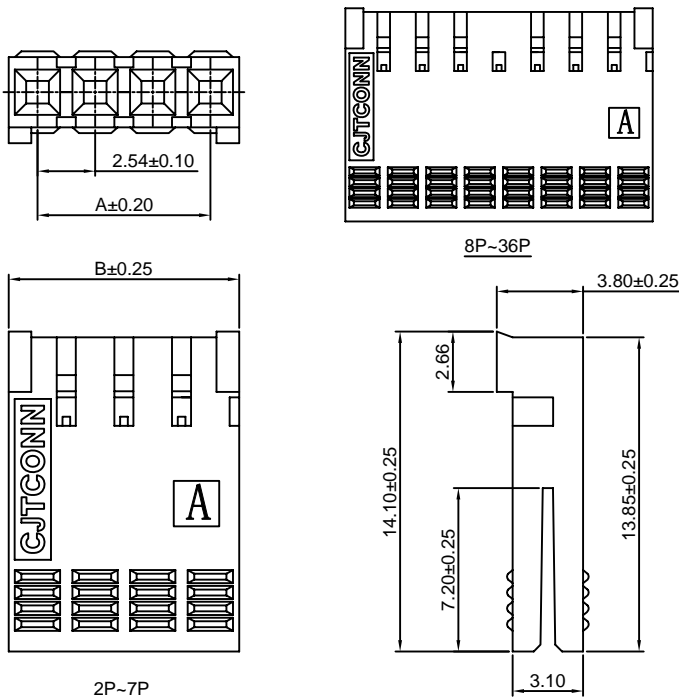
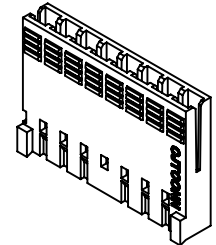

**Ordering Information & Dimensions:**

| PART NO. | Dimensions |       | PART NO. | Dimensions |       |
|----------|------------|-------|----------|------------|-------|
|          | A          | B     |          | A          | B     |
| 2P       | 2.54       | 5.08  | 20P      | 48.26      | 50.80 |
| 3P       | 5.08       | 7.62  | 21P      | 50.80      | 53.34 |
| 4P       | 7.62       | 10.16 | 22P      | 53.34      | 55.88 |
| 5P       | 10.16      | 12.70 | 23P      | 55.88      | 58.42 |
| 6P       | 12.70      | 15.24 | 24P      | 58.42      | 60.96 |
| 7P       | 15.24      | 17.78 | 25P      | 60.96      | 63.50 |
| 8P       | 17.78      | 20.32 | 26P      | 63.50      | 66.04 |
| 9P       | 20.32      | 22.86 | 27P      | 66.04      | 68.58 |
| 10P      | 22.86      | 25.40 | 28P      | 68.58      | 71.12 |
| 11P      | 25.40      | 27.94 | 29P      | 71.12      | 73.66 |
| 12P      | 27.94      | 30.48 | 30P      | 73.66      | 76.20 |
| 13P      | 30.48      | 33.02 | 31P      | 76.20      | 78.74 |
| 14P      | 33.02      | 35.56 | 32P      | 78.74      | 81.28 |
| 15P      | 35.56      | 38.10 | 33P      | 81.28      | 83.82 |
| 16P      | 38.10      | 40.64 | 34P      | 83.82      | 86.36 |
| 17P      | 40.64      | 43.18 | 35P      | 86.36      | 88.90 |
| 18P      | 43.18      | 45.72 | 36P      | 88.90      | 91.44 |
| 19P      | 45.72      | 48.26 |          |            |       |

Unit: mm

### A2550HL-XP

2.54mm Pitch Crimp Flex Housing

**Reference Informations:**

- \*Material:PBT30%GF,UL94V-0
- \*Suitable CJT A2550 series Terminal (A2550-T(-H), A2550-T(-H)-CR, A2550-T-A, A2550-T-C, A2550M-T)
- \*Mates with CJT A2541 series Wafer
- \*Color:Black

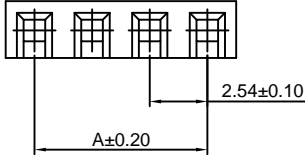
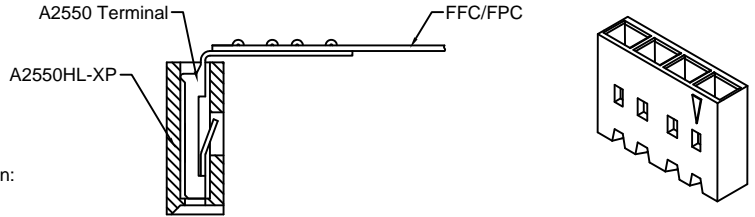

Ordering Information:  
A2550HL-XP - \*\*\*  
 1 2  
 1.Part No.  
 2.Material:  
 (blank):PBT30%GF,UL94V-0  
 GWT:PBT,UL94V-0,GWT 750°C

**Ordering Information & Dimensions:**

| PART NO. | Dimensions |       | PART NO. | Dimensions |       |
|----------|------------|-------|----------|------------|-------|
|          | A          | B     |          | A          | B     |
| 2P       | 2.54       | 5.08  | 20P      | 48.26      | 50.80 |
| 3P       | 5.08       | 7.62  | 21P      | 50.80      | 53.34 |
| 4P       | 7.62       | 10.16 | 22P      | 53.34      | 55.88 |
| 5P       | 10.16      | 12.70 | 23P      | 55.88      | 58.42 |
| 6P       | 12.70      | 15.24 | 24P      | 58.42      | 60.96 |
| 7P       | 15.24      | 17.78 | 25P      | 60.96      | 63.50 |
| 8P       | 17.78      | 20.32 | 26P      | 63.50      | 66.04 |
| 9P       | 20.32      | 22.86 | 27P      | 66.04      | 68.58 |
| 10P      | 22.86      | 25.40 | 28P      | 68.58      | 71.12 |
| 11P      | 25.40      | 27.94 | 29P      | 71.12      | 73.66 |
| 12P      | 27.94      | 30.48 | 30P      | 73.66      | 76.20 |
| 13P      | 30.48      | 33.02 | 31P      | 76.20      | 78.74 |
| 14P      | 33.02      | 35.56 | 32P      | 78.74      | 81.28 |
| 15P      | 35.56      | 38.10 | 33P      | 81.28      | 83.82 |
| 16P      | 38.10      | 40.64 | 34P      | 83.82      | 86.36 |
| 17P      | 40.64      | 43.18 | 35P      | 86.36      | 88.90 |
| 18P      | 43.18      | 45.72 | 36P      | 88.90      | 91.44 |
| 19P      | 45.72      | 48.26 |          |            |       |

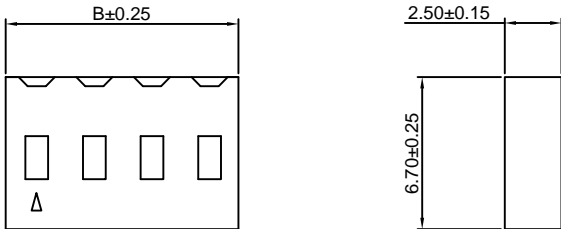

Unit: mm

### A2550H-XP-M

2.54mm Pitch Housing With Lock

**Reference Informations:**

- \*Material:PBT30%GF, UL94V-0
- \*Suitable CJT A2550-T-E series Terminal
- \*Mates with CJT A2547HM-XP A2550HM-XP series Housing or A2547 series single row Wafer
- \*Color:Black

Ordering Information:  
A2550H-XP-M - \*\*\*  
 1 2  
 1.Part No.  
 2.Material:  
 (blank):PBT30%GF,UL94V-0  
 GWT:PBT,UL94V-0,GWT 750°C

**Ordering Information & Dimensions:**

| PART NO. | Dimensions |       |
|----------|------------|-------|
|          | A          | B     |
| 2P       | 2.54       | 5.08  |
| 3P       | 5.08       | 7.62  |
| 4P       | 7.62       | 10.16 |
| 5P       | 10.16      | 12.70 |
| 6P       | 12.70      | 15.24 |
| 7P       | 15.24      | 17.78 |
| 8P       | 17.78      | 20.32 |
| 9P       | 20.32      | 22.86 |
| 10P      | 22.86      | 25.40 |
| 11P      | 25.40      | 27.94 |
| 12P      | 27.94      | 30.48 |
| 13P      | 30.48      | 33.02 |
| 14P      | 33.02      | 35.56 |
| 15P      | 35.56      | 38.10 |
| 16P      | 38.10      | 40.64 |
| 17P      | 40.64      | 43.18 |
| 18P      | 43.18      | 45.72 |
| 19P      | 45.72      | 48.26 |
| 20P      | 48.26      | 50.80 |
| 21P      | 50.80      | 53.34 |
| 22P      | 53.34      | 55.88 |
| 23P      | 55.88      | 58.42 |
| 24P      | 58.42      | 60.96 |
| 25P      | 60.96      | 63.50 |

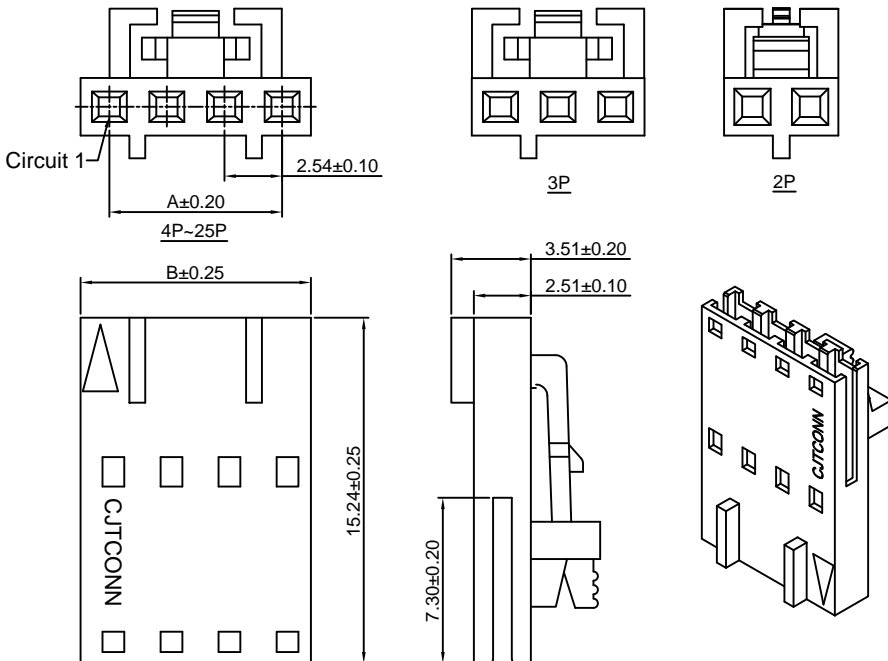

Unit: mm

### A2550H-XP-M1

2.54mm Pitch Housing

#### Reference Informations:

- \*Material:PBT30%GF , UL94V-0
- \*Suitable CJT A2550-T-E, A2550M-T-D series Terminal
- \*Mates with CJT A2547WV,WR-XP, A2547WVA,WRA-XP series single row Wafer
- \*Color:Black

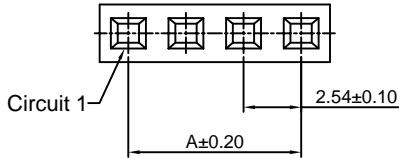

Ordering Information:  
**A2550H-XP-M1 - \*\*\***  
 1                      2

- 1.Part No.
- 2.Material:  
 (blank):PBT30%GF,UL94V-0  
 GWT:PBT,UL94V-0,GWT 750°C

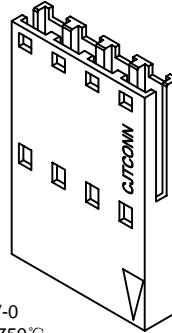

#### Ordering Information & Dimensions:

| PART NO. | Dimensions |       |
|----------|------------|-------|
|          | A          | B     |
| 2P       | 2.54       | 5.08  |
| 3P       | 5.08       | 7.62  |
| 4P       | 7.62       | 10.16 |
| 5P       | 10.16      | 12.70 |
| 6P       | 12.70      | 15.24 |
| 7P       | 15.24      | 17.78 |
| 8P       | 17.78      | 20.32 |
| 9P       | 20.32      | 22.86 |
| 10P      | 22.86      | 25.40 |
| 11P      | 25.40      | 27.94 |
| 12P      | 27.94      | 30.48 |
| 13P      | 30.48      | 33.02 |
| 14P      | 33.02      | 35.56 |
| 15P      | 35.56      | 38.10 |
| 16P      | 38.10      | 40.64 |
| 17P      | 40.64      | 43.18 |
| 18P      | 43.18      | 45.72 |
| 19P      | 45.72      | 48.26 |
| 20P      | 48.26      | 50.80 |
| 21P      | 50.80      | 53.34 |
| 22P      | 53.34      | 55.88 |
| 23P      | 55.88      | 58.42 |
| 24P      | 58.42      | 60.96 |
| 25P      | 60.96      | 63.50 |

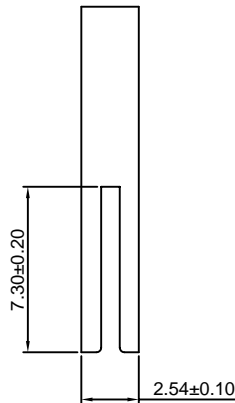
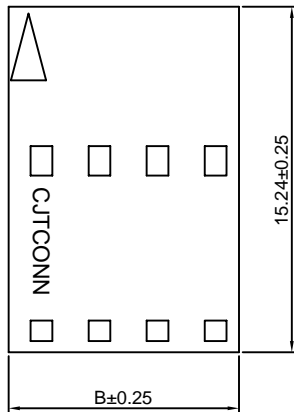

Unit: mm

### A2550H-XP-M2

2.54mm Pitch Housing

#### Reference Informations:

- \*Material:PBT30%GF , UL94V-0
- \*Suitable CJT A2550-T-E series Terminal
- \*Mates with CJT A2547WV,WR-XP, A2547WVA,WRA-XP series single row Wafer
- \*Color:Black

Ordering Information:  
**A2550H-XP-M2 - \*\*\***  
 1                      2

- 1.Part No.
- 2.Material:  
 (blank):PBT30%GF,UL94V-0  
 GWT:PBT,UL94V-0,GWT 750°C

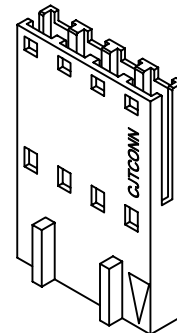
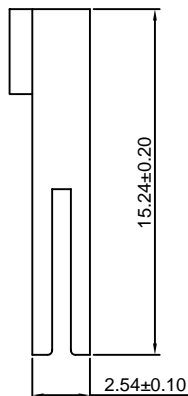
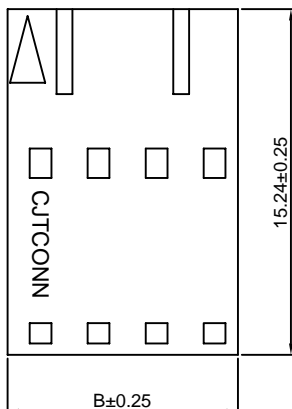
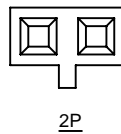
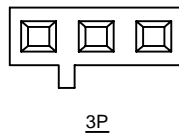
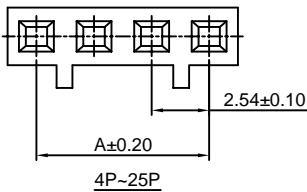

#### Ordering Information & Dimensions:

| PART NO. | Dimensions |       |
|----------|------------|-------|
|          | A          | B     |
| 2P       | 2.54       | 5.08  |
| 3P       | 5.08       | 7.62  |
| 4P       | 7.62       | 10.16 |
| 5P       | 10.16      | 12.70 |
| 6P       | 12.70      | 15.24 |
| 7P       | 15.24      | 17.78 |
| 8P       | 17.78      | 20.32 |
| 9P       | 20.32      | 22.86 |
| 10P      | 22.86      | 25.40 |
| 11P      | 25.40      | 27.94 |
| 12P      | 27.94      | 30.48 |
| 13P      | 30.48      | 33.02 |
| 14P      | 33.02      | 35.56 |
| 15P      | 35.56      | 38.10 |
| 16P      | 38.10      | 40.64 |
| 17P      | 40.64      | 43.18 |
| 18P      | 43.18      | 45.72 |
| 19P      | 45.72      | 48.26 |
| 20P      | 48.26      | 50.80 |
| 21P      | 50.80      | 53.34 |
| 22P      | 53.34      | 55.88 |
| 23P      | 55.88      | 58.42 |
| 24P      | 58.42      | 60.96 |
| 25P      | 60.96      | 63.50 |

Unit: mm

### A2550H-XP-M3

2.54mm Pitch Housing

**Reference Informations:**

- \*Material: PBT30%GF, UL94V-0
- \*Suitable CJT A2550-T-E, A2550M-T-D series Terminal
- \*Color: Black

**Ordering Information:**

- A2550H-XP-M3 - \*\*\*  
 $\frac{1}{2}$
1. Part No.  
 2. Material:  
 (blank): PBT30%GF, UL94V-0  
GWT: PBT, UL94V-0, GWT 750°C

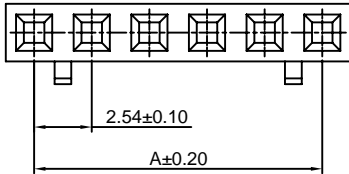

4P~25P

B±0.25

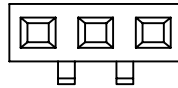
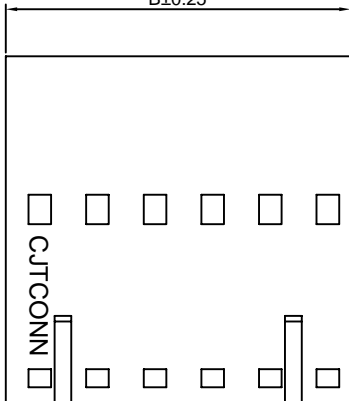

3P

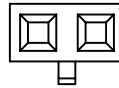

2P

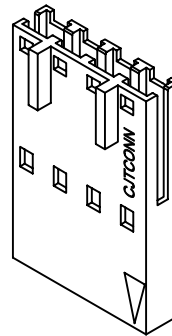
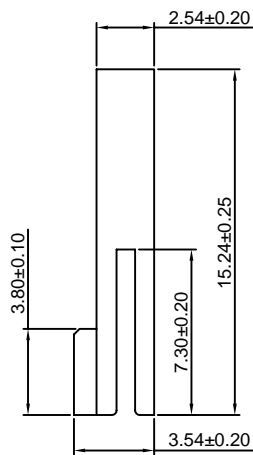

**Ordering Information & Dimensions:**

| PART NO. | Dimensions |       |
|----------|------------|-------|
|          | A          | B     |
| 2P       | 2.54       | 5.08  |
| 3P       | 5.08       | 7.62  |
| 4P       | 7.62       | 10.16 |
| 5P       | 10.16      | 12.70 |
| 6P       | 12.70      | 15.24 |
| 7P       | 15.24      | 17.78 |
| 8P       | 17.78      | 20.32 |
| 9P       | 20.32      | 22.86 |
| 10P      | 22.86      | 25.40 |
| 11P      | 25.40      | 27.94 |
| 12P      | 27.94      | 30.48 |
| 13P      | 30.48      | 33.02 |
| 14P      | 33.02      | 35.56 |
| 15P      | 35.56      | 38.10 |
| 16P      | 38.10      | 40.64 |
| 17P      | 40.64      | 43.18 |
| 18P      | 43.18      | 45.72 |
| 19P      | 45.72      | 48.26 |
| 20P      | 48.26      | 50.80 |
| 21P      | 50.80      | 53.34 |
| 22P      | 53.34      | 55.88 |
| 23P      | 55.88      | 58.42 |
| 24P      | 58.42      | 60.96 |
| 25P      | 60.96      | 63.50 |

Unit: mm

### A2550H-XP-MH

2.54mm Pitch Housing With Lock

**Reference Informations:**

- \*Material: PBT30%GF, UL94V-0
- \*Suitable CJT A2550-T-E series Terminal
- \*Mates with CJT A2547HM-XP A2550HM-XP series Housing or A2547 series single row Wafer
- \*Color: Black

**Ordering Information:**

- A2550H-XP-MH - \*\*\*  
 $\frac{1}{2}$
1. Part No.  
 2. Material:  
 (blank): PBT30%GF, UL94V-0  
GWT: PBT, UL94V-0, GWT 750°C

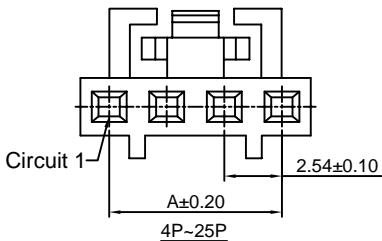

4P~25P

B±0.25

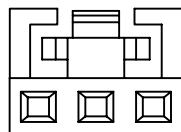
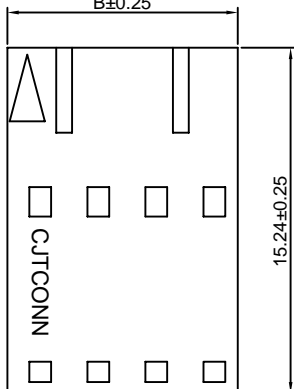

3P

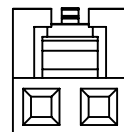

2P

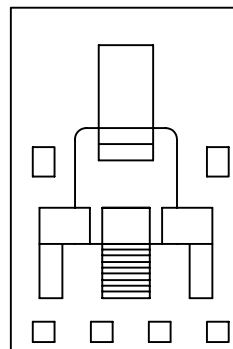
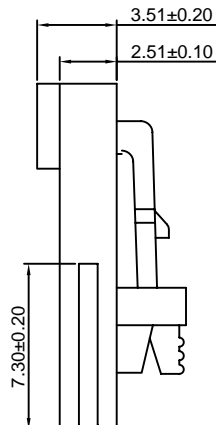

**Ordering Information & Dimensions:**

| PART NO. | Dimensions |       |
|----------|------------|-------|
|          | A          | B     |
| 2P       | 2.54       | 5.08  |
| 3P       | 5.08       | 7.62  |
| 4P       | 7.62       | 10.16 |
| 5P       | 10.16      | 12.70 |
| 6P       | 12.70      | 15.24 |
| 7P       | 15.24      | 17.78 |
| 8P       | 17.78      | 20.32 |
| 9P       | 20.32      | 22.86 |
| 10P      | 22.86      | 25.40 |
| 11P      | 25.40      | 27.94 |
| 12P      | 27.94      | 30.48 |
| 13P      | 30.48      | 33.02 |
| 14P      | 33.02      | 35.56 |
| 15P      | 35.56      | 38.10 |
| 16P      | 38.10      | 40.64 |
| 17P      | 40.64      | 43.18 |
| 18P      | 43.18      | 45.72 |
| 19P      | 45.72      | 48.26 |
| 20P      | 48.26      | 50.80 |
| 21P      | 50.80      | 53.34 |
| 22P      | 53.34      | 55.88 |
| 23P      | 55.88      | 58.42 |
| 24P      | 58.42      | 60.96 |
| 25P      | 60.96      | 63.50 |

Unit: mm

## A2550HH-N-XP

2.54mm Pitch Crimp Flex Housing

### Reference Informations:

- \*Material: PBT30%GF, UL94V-0
- \*Suitable CJT A2550 series Terminal (A2550-T(-H), A2550-T(-H)-CR, A2550-T-A, A2550-T-C, A2550M-T)
- \*Mates with CJT A2541 series Wafer
- \*Color: Black

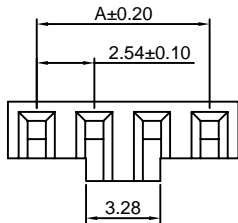

Ordering Information:  
A2550HH-N-XP - \*\*\*  
1 2

- 1. Part No.
- 2. Material:  
(blank): PBT30%GF, UL94V-0  
GWT: PBT, UL94V-0, GWT 750°C

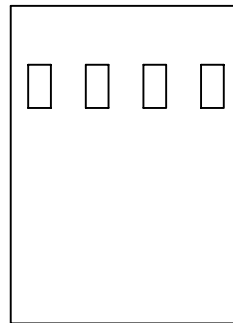
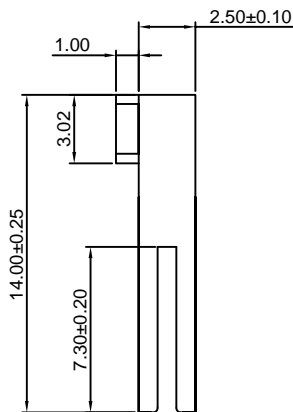
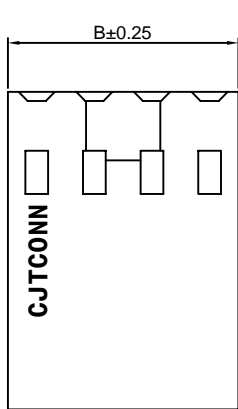

### Ordering Information & Dimensions:

| PART NO. | Dimensions |       |
|----------|------------|-------|
|          | A          | B     |
| 2P       | 2.54       | 5.08  |
| 3P       | 5.08       | 7.62  |
| 4P       | 7.62       | 10.16 |
| 5P       | 10.16      | 12.70 |
| 6P       | 12.70      | 15.24 |
| 7P       | 15.24      | 17.78 |
| 8P       | 17.78      | 20.32 |
| 9P       | 20.32      | 22.86 |
| 10P      | 22.86      | 25.40 |
| 11P      | 25.40      | 27.94 |
| 12P      | 27.94      | 30.48 |
| 13P      | 30.48      | 33.02 |
| 14P      | 33.02      | 35.56 |
| 15P      | 35.56      | 38.10 |
| 16P      | 38.10      | 40.64 |
| 17P      | 40.64      | 43.18 |
| 18P      | 43.18      | 45.72 |
| 19P      | 45.72      | 48.26 |
| 20P      | 48.26      | 50.80 |
| 21P      | 50.80      | 53.34 |
| 22P      | 53.34      | 55.88 |
| 23P      | 55.88      | 58.42 |
| 24P      | 58.42      | 60.96 |
| 25P      | 60.96      | 63.50 |

Unit: mm

## A2550HM-XP

2.54mm Pitch Crimp Flex Housing

### Reference Informations:

- \*Material: PBT30%GF, UL94V-0
- \*Suitable CJT A2550M-T-D series Terminal
- \*Mates with CJT A2550 series Housing (A2550H-XP-A, A2550H-XP-A1, A2550H-XP-A2, A2550H-XP-H, A2547H, HA-XP)
- \*Color: Black

Ordering Information:  
A2550HM-XP - \*\*\*  
1 2

- 1. Part No.
- 2. Material:  
(blank): PBT30%GF, UL94V-0  
GWT: PBT, UL94V-0, GWT 750°C

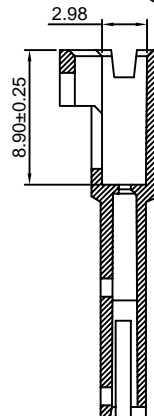
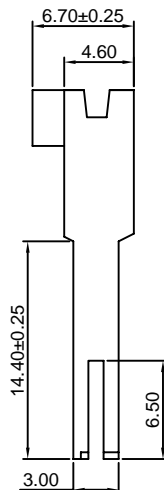
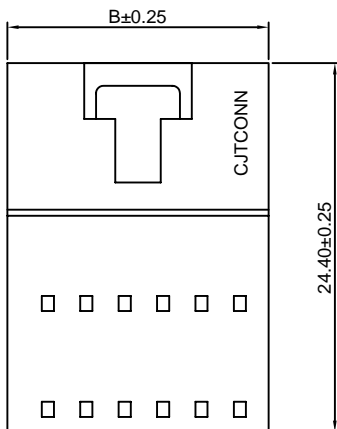
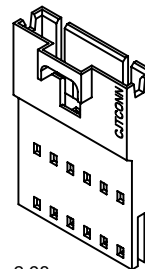
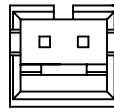
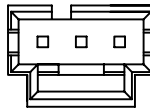
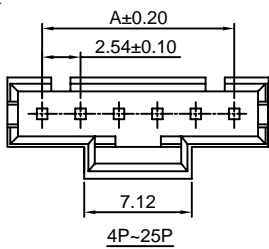

### Ordering Information & Dimensions:

| PART NO. | Dimensions |       |
|----------|------------|-------|
|          | A          | B     |
| 2P       | 2.54       | 7.12  |
| 3P       | 5.08       | 9.66  |
| 4P       | 7.62       | 12.20 |
| 5P       | 10.16      | 14.74 |
| 6P       | 12.70      | 17.28 |
| 7P       | 15.24      | 19.82 |
| 8P       | 17.78      | 22.36 |
| 9P       | 20.32      | 24.90 |
| 10P      | 22.86      | 27.44 |
| 11P      | 25.40      | 29.98 |
| 12P      | 27.94      | 32.52 |
| 13P      | 30.48      | 35.06 |
| 14P      | 33.02      | 37.60 |
| 15P      | 35.56      | 40.14 |
| 16P      | 38.10      | 42.68 |
| 17P      | 40.64      | 45.22 |
| 18P      | 43.18      | 47.76 |
| 19P      | 45.72      | 50.30 |
| 20P      | 48.26      | 52.84 |
| 21P      | 50.80      | 55.38 |
| 22P      | 53.34      | 57.92 |
| 23P      | 55.88      | 60.46 |
| 24P      | 58.42      | 63.00 |
| 25P      | 60.96      | 65.54 |

Unit: mm



### A2550HMA-XP

2.54mm Pitch Crimp Flex Housing

**Reference Informations:**

- \*Material: PBT30%GF, UL94V-0
- \*Suitable CJT A2550M-T-D series Terminal
- \*Mates with CJT A2550H-XP-B, A2547H-XP-3 series Housing
- \*Color: Black

**Ordering Information:**

- A2550HMA-XP - \*\*\*  
 1 2
1. Part No.
  2. Material:  
 (blank): PBT30%GF, UL94V-0  
 GWT: PBT, UL94V-0, GWT 750°C

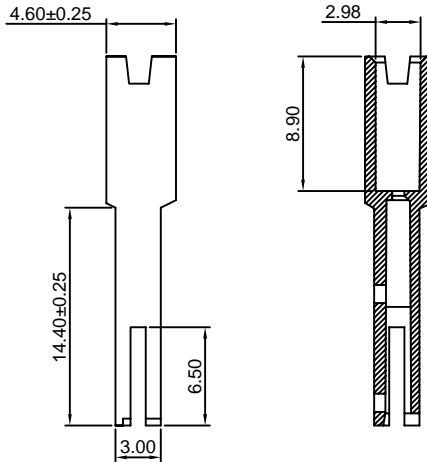
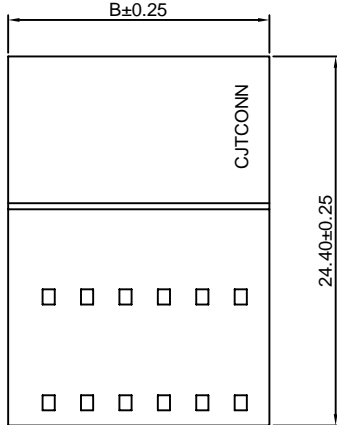

**Ordering Information & Dimensions:**

| PART NO. | Dimensions |       |
|----------|------------|-------|
|          | A          | B     |
| 2P       | 2.54       | 7.12  |
| 3P       | 5.08       | 9.66  |
| 4P       | 7.62       | 12.20 |
| 5P       | 10.16      | 14.74 |
| 6P       | 12.70      | 17.28 |
| 7P       | 15.24      | 19.82 |
| 8P       | 17.78      | 22.36 |
| 9P       | 20.32      | 24.90 |
| 10P      | 22.86      | 27.44 |
| 11P      | 25.40      | 29.98 |
| 12P      | 27.94      | 32.52 |
| 13P      | 30.48      | 35.06 |
| 14P      | 33.02      | 37.60 |
| 15P      | 35.56      | 40.14 |
| 16P      | 38.10      | 42.68 |
| 17P      | 40.64      | 45.22 |
| 18P      | 43.18      | 47.76 |
| 19P      | 45.72      | 50.30 |
| 20P      | 48.26      | 52.84 |
| 21P      | 50.80      | 55.38 |
| 22P      | 53.34      | 57.92 |
| 23P      | 55.88      | 60.46 |
| 24P      | 58.42      | 63.00 |
| 25P      | 60.96      | 65.54 |

Unit: mm

### A2550H-2xXP

2.54mm Pitch Crimp Flex Housing

**Reference Informations:**

- \*Material: PBT30%GF, UL94V-0
- \*Suitable CJT A2550 series Terminal (A2550-T(-H), A2550-T(-H)-CR, A2550-T-A, A2550-T-C, A2550M-T)
- \*Mates with CJT A2541 series Wafer
- \*Color: Black

**Ordering Information:**

- A2550H-2xXP - \*\*\*  
 1 2
1. Part No.
  2. Material:  
 (blank): PBT30%GF, UL94V-0  
 GWT: PBT, UL94V-0, GWT 750°C

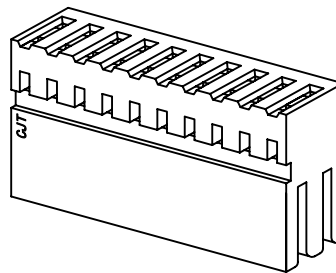
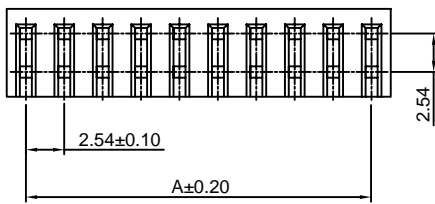

**Ordering Information & Dimensions:**

| PART NO. | Dimensions |       |
|----------|------------|-------|
|          | A          | B     |
| 2x2P     | 2.54       | 5.08  |
| 2x3P     | 5.08       | 7.62  |
| 2x4P     | 7.62       | 10.16 |
| 2x5P     | 10.16      | 12.70 |
| 2x6P     | 12.70      | 15.24 |
| 2x7P     | 15.24      | 17.78 |
| 2x8P     | 17.78      | 20.32 |
| 2x9P     | 20.32      | 22.86 |
| 2x10P    | 22.86      | 25.40 |
| 2x11P    | 25.40      | 27.94 |
| 2x12P    | 27.94      | 30.48 |
| 2x13P    | 30.48      | 33.02 |
| 2x14P    | 33.02      | 35.56 |
| 2x15P    | 35.56      | 38.10 |
| 2x16P    | 38.10      | 40.64 |
| 2x17P    | 40.64      | 43.18 |
| 2x18P    | 43.18      | 45.72 |
| 2x19P    | 45.72      | 48.26 |
| 2x20P    | 48.26      | 50.80 |
| 2x21P    | 50.80      | 53.34 |
| 2x22P    | 53.34      | 55.88 |
| 2x23P    | 55.88      | 58.42 |
| 2x24P    | 58.42      | 60.96 |
| 2x25P    | 60.96      | 63.50 |

Unit: mm

### A2550HA-2xXP

2.54mm Pitch Crimp Flex Housing

**Reference Informations:**

- \*Material: PBT30%GF, UL94V-0
- \*Suitable CJT A2550 series Terminal (A2550-T(-H), A2550-T(-H)-CR, A2550-T-A, A2550-T-C)
- \*Mates with CJT A2549WVB, WRB-2xXP series Dual Row Wafer
- \*Color: Black

**Ordering Information:**

- A2550HA-2xXP - \*\*\*  
 1 2  
 1. Part No.  
 2. Material:  
 (blank): PBT30%GF, UL94V-0  
 GWT: PBT, UL94V-0, GWT 750 °C

**Ordering Information & Dimensions:**

| PART NO. | Dimensions |       |
|----------|------------|-------|
|          | A          | B     |
| 2x2P     | 2.54       | 5.08  |
| 2x3P     | 5.08       | 7.62  |
| 2x4P     | 7.62       | 10.16 |
| 2x5P     | 10.16      | 12.70 |
| 2x6P     | 12.70      | 15.24 |
| 2x7P     | 15.24      | 17.78 |
| 2x8P     | 17.78      | 20.32 |
| 2x9P     | 20.32      | 22.86 |
| 2x10P    | 22.86      | 25.40 |
| 2x11P    | 25.40      | 27.94 |
| 2x12P    | 27.94      | 30.48 |
| 2x13P    | 30.48      | 33.02 |
| 2x14P    | 33.02      | 35.56 |
| 2x15P    | 35.56      | 38.10 |
| 2x16P    | 38.10      | 40.64 |
| 2x17P    | 40.64      | 43.18 |
| 2x18P    | 43.18      | 45.72 |
| 2x19P    | 45.72      | 48.26 |
| 2x20P    | 48.26      | 50.80 |
| 2x21P    | 50.80      | 53.34 |
| 2x22P    | 53.34      | 55.88 |
| 2x23P    | 55.88      | 58.42 |
| 2x24P    | 58.42      | 60.96 |
| 2x25P    | 60.96      | 63.50 |

Unit: mm

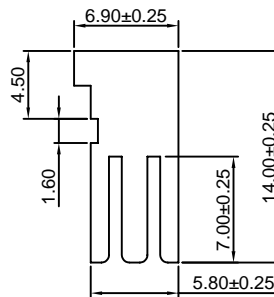
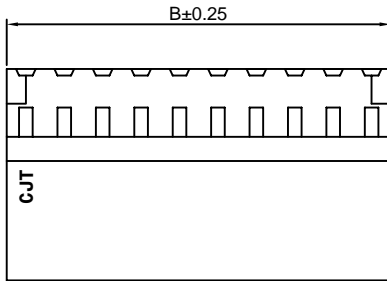
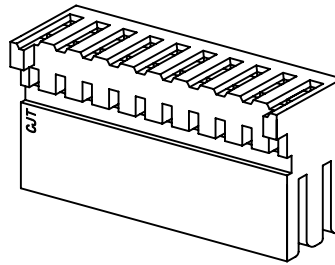
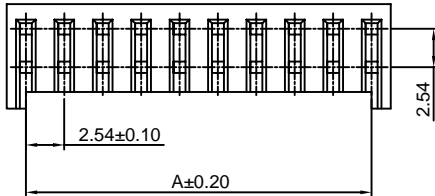

### A2550H-N-2xXP

2.54mm Pitch Crimp Flex Housing

**Reference Informations:**

- \*Material: PBT30%GF, UL94V-0
- \*Suitable CJT A2550 series Terminal (A2550-T(-H), A2550-T(-H)-CR, A2550-T-A, A2550-T-C, A2550M-T)
- \*Mates with CJT A2541 series Wafer or A2547WV, WR-2xXP series Wafer
- \*Color: Black

**Ordering Information:**

- A2550H-N-2xXP - \*\*\*  
 1 2  
 1. Part No.  
 2. Material:  
 (blank): PBT30%GF, UL94V-0  
 GWT: PBT, UL94V-0, GWT 750 °C

**Ordering Information & Dimensions:**

| PART NO. | Dimensions |       |
|----------|------------|-------|
|          | A          | B     |
| 2x2P     | 2.54       | 5.08  |
| 2x3P     | 5.08       | 7.62  |
| 2x4P     | 7.62       | 10.16 |
| 2x5P     | 10.16      | 12.70 |
| 2x6P     | 12.70      | 15.24 |
| 2x7P     | 15.24      | 17.78 |
| 2x8P     | 17.78      | 20.32 |
| 2x9P     | 20.32      | 22.86 |
| 2x10P    | 22.86      | 25.40 |
| 2x11P    | 25.40      | 27.94 |
| 2x12P    | 27.94      | 30.48 |
| 2x13P    | 30.48      | 33.02 |
| 2x14P    | 33.02      | 35.56 |
| 2x15P    | 35.56      | 38.10 |
| 2x16P    | 38.10      | 40.64 |
| 2x17P    | 40.64      | 43.18 |
| 2x18P    | 43.18      | 45.72 |
| 2x19P    | 45.72      | 48.26 |
| 2x20P    | 48.26      | 50.80 |
| 2x21P    | 50.80      | 53.34 |
| 2x22P    | 53.34      | 55.88 |
| 2x23P    | 55.88      | 58.42 |
| 2x24P    | 58.42      | 60.96 |
| 2x25P    | 60.96      | 63.50 |

Unit: mm

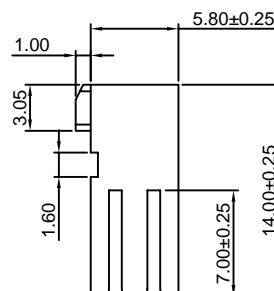
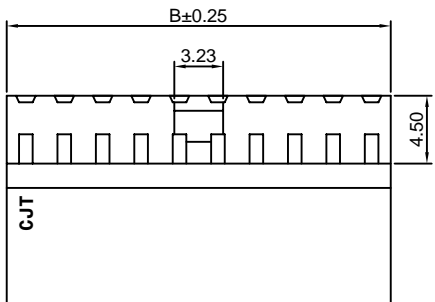
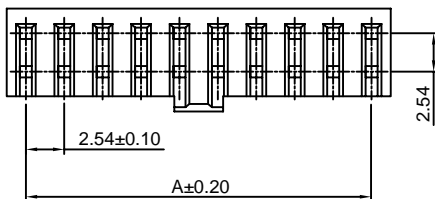

### A2550HK-2xXP

2.54mm Pitch Crimp Flex Housing

**Reference Informations:**

- \*Material: PBT30%GF, UL94V-0
- \*Suitable CJT A2550 series Terminal (A2550-T-K)
- \*Color: Blue

**Ordering Information:**

A2550HK-2xXP - \*\*\*  
1 2

- 1. Part No.
- 2. Material:  
(blank): PBT30%GF, UL94V-0  
GWT: PBT, UL94V-0, GWT 750°C

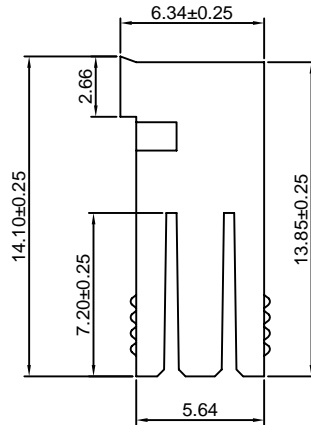
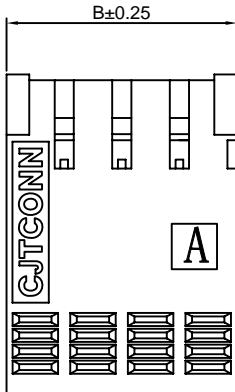
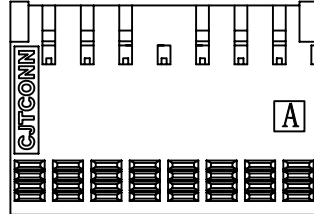
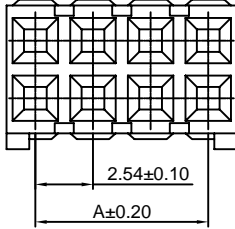
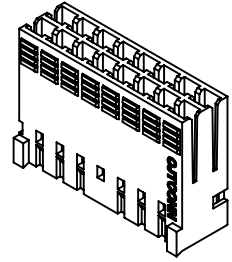

**Ordering Information & Dimensions:**

| PART NO. | Dimensions |       | PART NO. | Dimensions |       |
|----------|------------|-------|----------|------------|-------|
|          | A          | B     |          | A          | B     |
| 2x2P     | 2.54       | 5.08  | 2x20P    | 48.26      | 50.80 |
| 2x3P     | 5.08       | 7.62  | 2x21P    | 50.80      | 53.34 |
| 2x4P     | 7.62       | 10.16 | 2x22P    | 53.34      | 55.88 |
| 2x5P     | 10.16      | 12.70 | 2x23P    | 55.88      | 58.42 |
| 2x6P     | 12.70      | 15.24 | 2x24P    | 58.42      | 60.96 |
| 2x7P     | 15.24      | 17.78 | 2x25P    | 60.96      | 63.50 |
| 2x8P     | 17.78      | 20.32 | 2x26P    | 63.50      | 66.04 |
| 2x9P     | 20.32      | 22.86 | 2x27P    | 66.04      | 68.58 |
| 2x10P    | 22.86      | 25.40 | 2x28P    | 68.58      | 71.12 |
| 2x11P    | 25.40      | 27.94 | 2x29P    | 71.12      | 73.66 |
| 2x12P    | 27.94      | 30.48 | 2x30P    | 73.66      | 76.20 |
| 2x13P    | 30.48      | 33.02 | 2x31P    | 76.20      | 78.74 |
| 2x14P    | 33.02      | 35.56 | 2x32P    | 78.74      | 81.28 |
| 2x15P    | 35.56      | 38.10 | 2x33P    | 81.28      | 83.82 |
| 2x16P    | 38.10      | 40.64 | 2x34P    | 83.82      | 86.36 |
| 2x17P    | 40.64      | 43.18 | 2x35P    | 86.36      | 88.90 |
| 2x18P    | 43.18      | 45.72 | 2x36P    | 88.90      | 91.44 |
| 2x19P    | 45.72      | 48.26 |          |            |       |

Unit: mm

### A2550WVF-XP

2.54mm Pitch Crimp Flex Wafer

**Reference Informations:**

- \*Material: PBT, UL94V-0
- \*Terminal Material: Phosphor Bronze/Tin over Nickel
- \*Color: Black

**Ordering Information:**

A2550WVF-XP - \*\*\*  
1 2

- 1. Part No.
- 2. Material:  
(blank): PBT, UL94V-0  
GWT: PBT, UL94V-0, GWT 750°C

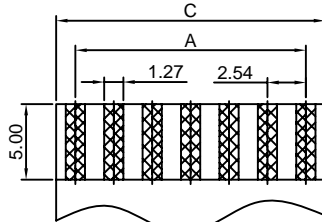
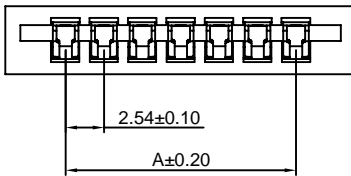
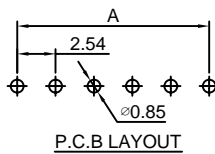
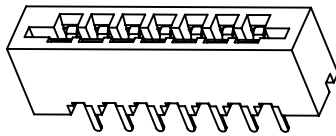

FPC/FFC T=0.30

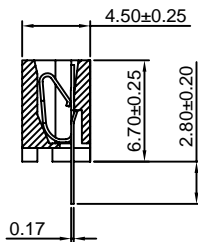
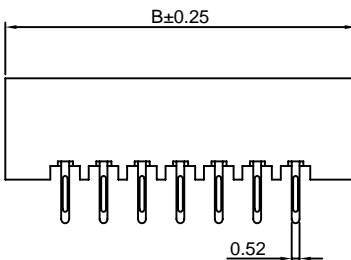

**Ordering Information & Dimensions:**

| PART NO. | Dimensions |       |       |
|----------|------------|-------|-------|
|          | A          | B     | C     |
| 3P       | 5.08       | 13.04 | 10.16 |
| 4P       | 7.62       | 15.58 | 12.70 |
| 5P       | 10.16      | 18.12 | 15.24 |
| 6P       | 12.70      | 20.66 | 17.78 |
| 7P       | 15.24      | 23.20 | 20.32 |
| 8P       | 17.78      | 25.74 | 22.86 |
| 9P       | 20.32      | 28.28 | 25.40 |
| 10P      | 22.86      | 30.82 | 27.94 |
| 11P      | 25.40      | 33.36 | 30.48 |
| 12P      | 27.94      | 35.90 | 33.02 |
| 13P      | 30.48      | 38.44 | 35.56 |
| 14P      | 33.02      | 40.98 | 38.10 |
| 15P      | 35.56      | 43.52 | 40.64 |
| 16P      | 38.10      | 46.06 | 43.18 |
| 17P      | 40.64      | 48.60 | 45.72 |
| 18P      | 43.18      | 51.14 | 48.26 |
| 19P      | 45.72      | 53.68 | 50.80 |
| 20P      | 48.26      | 56.22 | 53.34 |
| 21P      | 50.80      | 58.76 | 55.88 |
| 22P      | 53.34      | 61.30 | 58.42 |
| 23P      | 55.88      | 63.84 | 60.96 |
| 24P      | 58.42      | 66.38 | 63.50 |
| 25P      | 60.96      | 68.92 | 66.04 |

Unit: mm

## A2550WRF-XP

2.54mm Pitch Crimp Flex Wafer

**Reference Informations:**

- \*Material: PBT, UL94V-0
- \*Terminal Material: Phosphor Bronze/Tin over Nickel
- \*Color: Black

**Ordering Information:**

- A2550WRF-XP - \*\*\*
- |   |   |
|---|---|
| 1 | 2 |
|---|---|
- 1. Part No.
  - 2. Material:  
(blank): PBT, UL94V-0  
GWT: PBT, UL94V-0, GWT 750°C

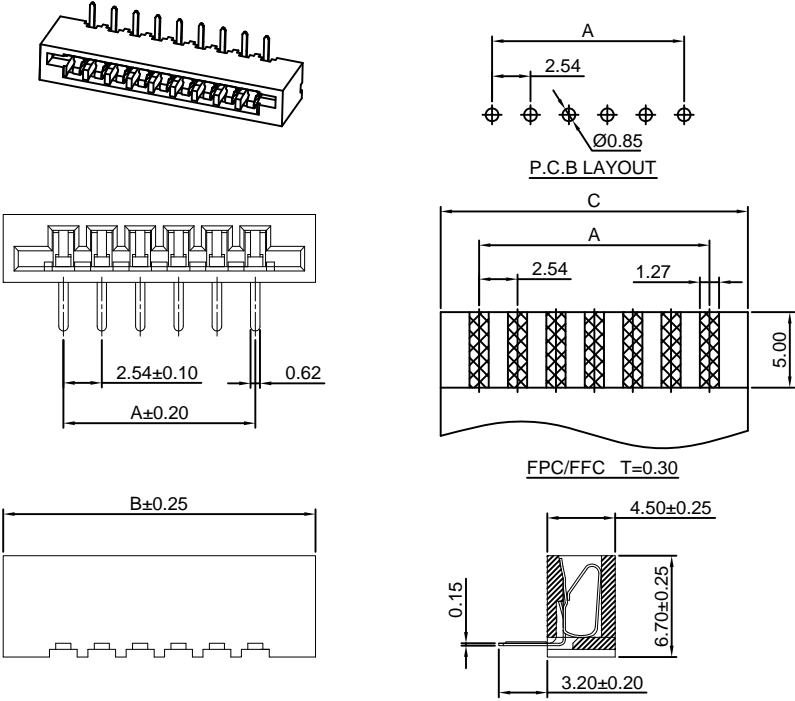

**Ordering Information & Dimensions:**

| PART NO. | Dimensions |       |       |
|----------|------------|-------|-------|
|          | A          | B     | C     |
| 3P       | 5.08       | 13.04 | 10.16 |
| 4P       | 7.62       | 15.58 | 12.70 |
| 5P       | 10.16      | 18.12 | 15.24 |
| 6P       | 12.70      | 20.66 | 17.78 |
| 7P       | 15.24      | 23.20 | 20.32 |
| 8P       | 17.78      | 25.74 | 22.86 |
| 9P       | 20.32      | 28.28 | 25.40 |
| 10P      | 22.86      | 30.82 | 27.94 |
| 11P      | 25.40      | 33.36 | 30.48 |
| 12P      | 27.94      | 35.90 | 33.02 |
| 13P      | 30.48      | 38.44 | 35.56 |
| 14P      | 33.02      | 40.98 | 38.10 |
| 15P      | 35.56      | 43.52 | 40.64 |
| 16P      | 38.10      | 46.06 | 43.18 |
| 17P      | 40.64      | 48.60 | 45.72 |
| 18P      | 43.18      | 51.14 | 48.26 |
| 19P      | 45.72      | 53.68 | 50.80 |
| 20P      | 48.26      | 56.22 | 53.34 |
| 21P      | 50.80      | 58.76 | 55.88 |
| 22P      | 53.34      | 61.30 | 58.42 |
| 23P      | 55.88      | 63.84 | 60.96 |
| 24P      | 58.42      | 66.38 | 63.50 |
| 25P      | 60.96      | 68.92 | 66.04 |

Unit: mm

## A2550WVFD-F-XP

2.54mm Pitch Crimp Flex Wafer

**Reference Informations:**

- \*Material: Nylon 66, UL94V-0
- \*Terminal Material: Phosphor Bronze/Tin over Nickel
- \*Color: White

**Ordering Information:**

- A2550WVFD-F-XP - \*\*\*
- |   |   |
|---|---|
| 1 | 2 |
|---|---|
- 1. Part No.
  - 2. Material:  
(blank): Nylon 66, UL94V-0  
GWT: Nylon 66, UL94V-0, GWT 750°C

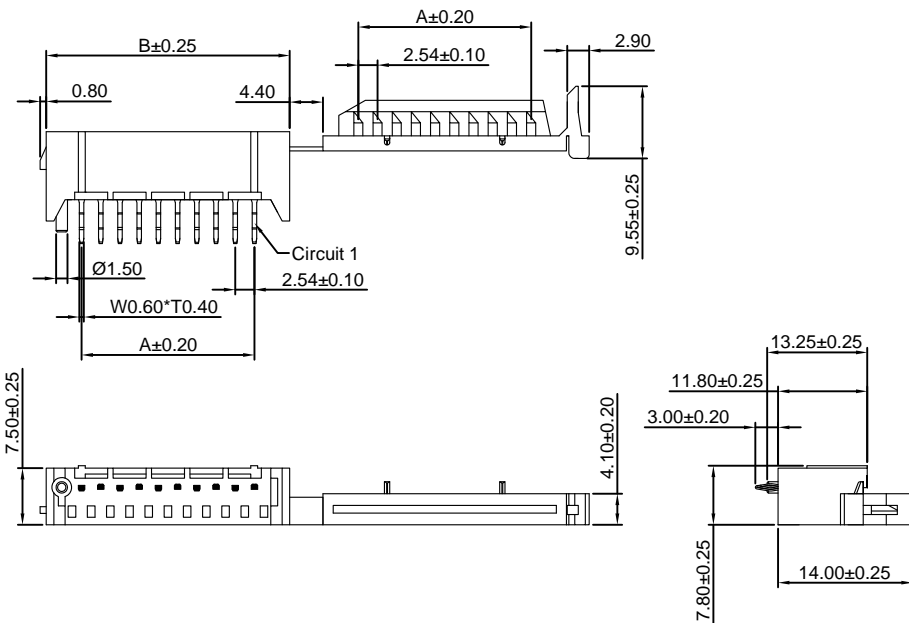

**Ordering Information & Dimensions:**

| PART NO. | Dimensions |       |
|----------|------------|-------|
|          | A          | B     |
| 1P       | ---        | 9.34  |
| 2P       | 2.54       | 11.88 |
| 3P       | 5.08       | 14.42 |
| 4P       | 7.62       | 16.96 |
| 5P       | 10.16      | 19.50 |
| 6P       | 12.70      | 22.04 |
| 7P       | 15.24      | 24.58 |
| 8P       | 17.78      | 27.12 |
| 9P       | 20.32      | 29.66 |
| 10P      | 22.86      | 32.20 |
| 11P      | 25.40      | 34.74 |
| 12P      | 27.94      | 37.28 |
| 13P      | 30.48      | 39.82 |
| 14P      | 33.02      | 42.36 |
| 15P      | 35.56      | 44.90 |
| 16P      | 38.10      | 47.44 |
| 17P      | 40.64      | 49.98 |
| 18P      | 43.18      | 52.52 |
| 19P      | 45.72      | 55.06 |
| 20P      | 48.26      | 57.60 |
| 21P      | 50.80      | 60.14 |
| 22P      | 53.34      | 62.68 |
| 23P      | 55.88      | 65.22 |
| 24P      | 58.42      | 67.76 |
| 25P      | 60.96      | 70.30 |

Unit: mm

### A2550WRFD-XP

2.54mm Pitch Crimp Flex Wafer

**Reference Informations:**

- \*Material:Nylon 66,UL94V-0
- \*Terminal Material:Phosphor Bronze/Tin over Nickel
- \*Color:White

**Ordering Information:**

- A2550WRFD-XP - \*\*\*
- 1 2
- 1.Part No.
- 2.Material:
- (blank):Nylon 66,UL94V-0
- GWT:Nylon 66,UL94V-0,GWT 750°C

**Ordering Information & Dimensions:**

| PART NO. | Dimensions |       |
|----------|------------|-------|
|          | A          | B     |
| 1P       | ----       | 9.34  |
| 2P       | 2.54       | 11.88 |
| 3P       | 5.08       | 14.42 |
| 4P       | 7.62       | 16.96 |
| 5P       | 10.16      | 19.50 |
| 6P       | 12.70      | 22.04 |
| 7P       | 15.24      | 24.58 |
| 8P       | 17.78      | 27.12 |
| 9P       | 20.32      | 29.66 |
| 10P      | 22.86      | 32.20 |
| 11P      | 25.40      | 34.74 |
| 12P      | 27.94      | 37.28 |
| 13P      | 30.48      | 39.82 |
| 14P      | 33.02      | 42.36 |
| 15P      | 35.56      | 44.90 |
| 16P      | 38.10      | 47.44 |
| 17P      | 40.64      | 49.98 |
| 18P      | 43.18      | 52.52 |
| 19P      | 45.72      | 55.06 |
| 20P      | 48.26      | 57.60 |
| 21P      | 50.80      | 60.14 |
| 22P      | 53.34      | 62.68 |
| 23P      | 55.88      | 65.22 |
| 24P      | 58.42      | 67.76 |
| 25P      | 60.96      | 70.30 |

Unit: mm

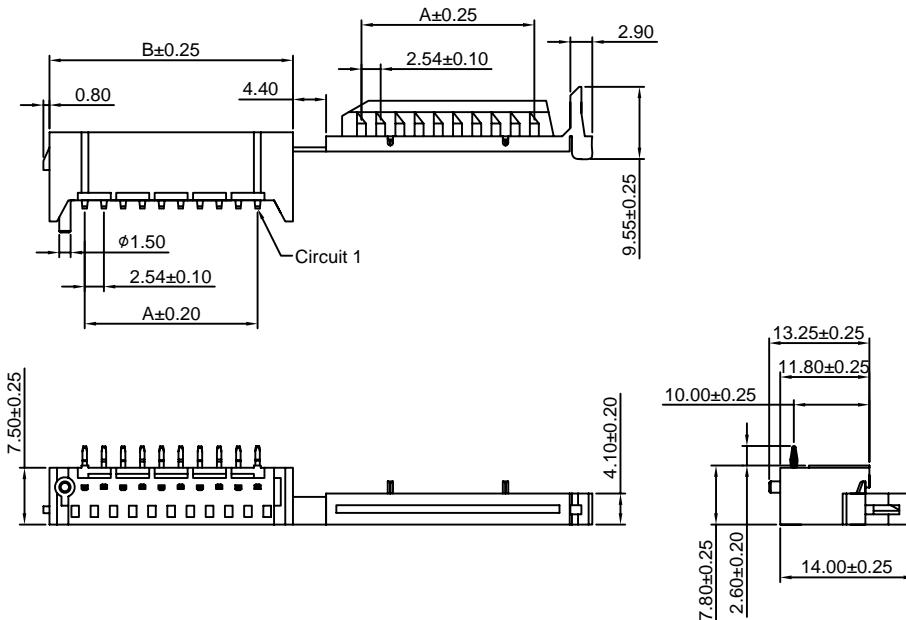

### A2550WVFC-F-XP

2.54mm Pitch Crimp Flex Wafer

**Reference Informations:**

- \*Material:PBT,UL94V-0
- \*Terminal Material:Phosphor Bronze/Tin over Nickel
- \*Color:Blue

**Ordering Information:**

- A2550WVFC-F-XP - \*\*\*
- 1 2
- 1.Part No.
- 2.Material:
- (blank):PBT,UL94V-0
- GWT:PBT,UL94V-0,GWT 750°C

**Ordering Information & Dimensions:**

| PART NO. | Dimensions |       |       |       |
|----------|------------|-------|-------|-------|
|          | A          | B     | C     | D     |
| 8P       | 17.78      | 30.34 | 23.12 | 10.16 |
| 9P       | 20.32      | 32.88 | 25.66 | 12.70 |
| 10P      | 22.86      | 35.42 | 28.20 | 15.24 |
| 11P      | 25.40      | 37.96 | 30.74 | 17.78 |
| 12P      | 27.94      | 40.50 | 33.28 | 20.32 |
| 13P      | 30.48      | 43.04 | 35.82 | 22.86 |

Unit: mm

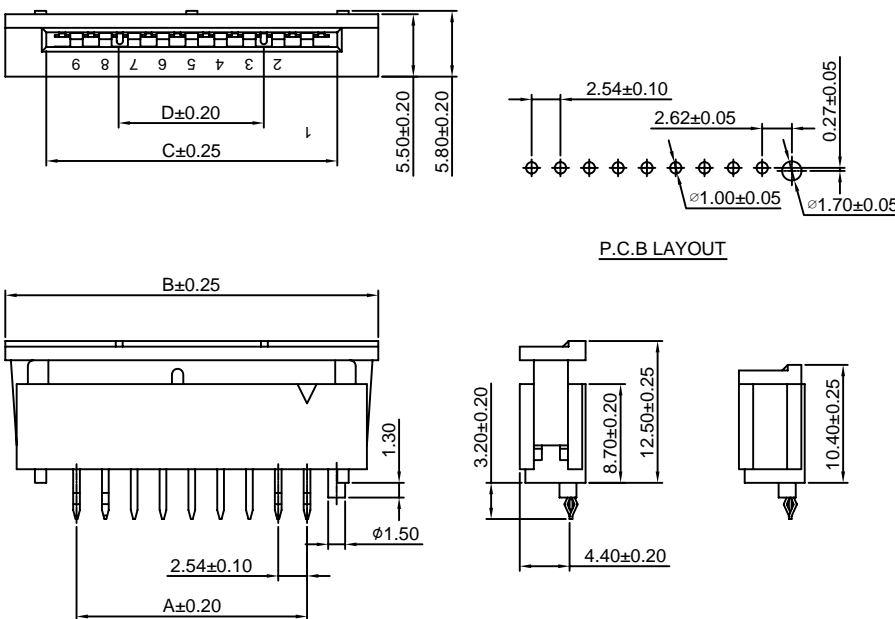

### A2550HXXP-L-01

2.54mm Pitch FFC Cable



| CN1 CN2      |                            |
|--------------|----------------------------|
| ① Terminal   | ② Housing                  |
|              | A2550H,HA,HB-XP            |
| A2550-T      | A2550H-XP-A,A2550H-XP-A1   |
| A2550-T-H    | A2550H-XP-A2,A2550H-XP-A2H |
| A2550-T-CR   | A2550H-XP-A3H,A2550H-XP-B  |
| A2550-T-H-CR | A2550H-XP-BH               |
| A2550-T-A    | A2550H-XP-C,A2550H-XP-C1   |
| A2550-T-C    | A2550H-XP-D,A2550H-XP-E    |
|              | A2550H-XP-F,A2550H-XP-J    |
|              | A2550H,HA-2xXP             |
| A2550-T-E    | A2550H-XP-M,A2550H-XP-M1   |
|              | A2550H-XP-M2,A2550H-XP-M3  |
| A2550-T-J    | A2550H-XP-G,A2550H-XP-G1   |
|              | A2550H-XP-H,A2550H-XP-H1   |
|              | A2550H-XP-I,A2550H-XP-I1   |
| A2550-T-K    | A2550HK-XP,A2550HK-2xXP    |
| A2550M-T     | A2550H-XP,A2550H-XP-D      |
|              | A2550H-XP-J,A2550H-2xXP    |

Unit: mm

### A2550HXXPA2550MXX-L-01

2.54mm Pitch FFC Cable



| ① Terminal   | CN1                        |                           | CN2 |
|--------------|----------------------------|---------------------------|-----|
|              | ② Housing                  | ③ Terminal                |     |
|              | A2550H,HA,HB-XP            |                           |     |
| A2550-T      | A2550H-XP-A,A2550H-XP-A1   |                           |     |
| A2550-T-H    | A2550H-XP-A2,A2550H-XP-A2H |                           |     |
| A2550-T-CR   | A2550H-XP-A3H,A2550H-XP-B  |                           |     |
| A2550-T-H-CR | A2550H-XP-BH               |                           |     |
| A2550-T-A    | A2550H-XP-C,A2550H-XP-C1   | A2550M-T-C, A2550M-T-CA   |     |
| A2550-T-C    | A2550H-XP-D,A2550H-XP-E    | A2550M-T-C1, A2550M-T-C1A |     |
|              | A2550H-XP-F,A2550H-XP-J    | A2550M-T-C2, A2550M-T-E   |     |
|              | A2550H,HA-2xXP             | A2550M-T-KE, A2550M-T-F   |     |
| A2550-T-E    | A2550H-XP-M,A2550H-XP-M1   | A2550M-T-G, A2550MA-T-G   |     |
|              | A2550H-XP-M2,A2550H-XP-M3  | A2550M-T-J, A2550M-T-K    |     |
| A2550-T-J    | A2550H-XP-G,A2550H-XP-G1   |                           |     |
|              | A2550H-XP-H,A2550H-XP-H1   |                           |     |
|              | A2550H-XP-I,A2550H-XP-I1   |                           |     |
| A2550-T-K    | A2550HK-XP,A2550HK-2xXP    |                           |     |
| A2550M-T     | A2550H-XP,A2550H-XP-D      |                           |     |
|              | A2550H-XP-J,A2550H-2xXP    |                           |     |

Unit: mm

## X-ON Electronics

Largest Supplier of Electrical and Electronic Components

*Click to view similar products for [Headers & Wire Housings](#) category:*

*Click to view products by [Changjiang](#) manufacturer:*

Other Similar products are found below :

[95000-104TRLF](#) [10135584-644402LF](#) [DF62W-EP2022PCA](#) [95000-106TRLF](#) [DF62W-2022SCA](#) [DF62W-EP2022PC](#) [2203348](#) [DF62W-2022SC](#) [1084018](#) [1029039](#) [1084017](#) [802-10-012-10-002000](#) [1112640](#) [1112639](#) [891-007-9SS-BST1T](#) [000-34000](#) [0008550134](#) [0009482033](#) [0009507031](#) [57102-F02-18ULF](#) [57102-S06-03LF](#) [57202-S52-04LF](#) [PCN6-15S-2.5E](#) [0039019024](#) [58102-G61-06LF](#) [582553-1](#) [0009485154](#) [0009508121](#) [0022285053](#) [0050291907](#) [018731A](#) [LY20-4P-DT1-P1E-BR](#) [02.125.8002.8](#) [60101931](#) [60598-1 \(Cut Strip\)](#) [M1625-3R/100](#) [61062-3](#) [61082-181009](#) [CSU011177004](#) [636-1427](#) [638009-1](#) [641938-9](#) [641991-4](#) [644168-1](#) [644827-2](#) [647662-1](#) [65039-019ELF](#) [65692-001LF](#) [65781-018](#) [65781-047](#)