

Specifications

- Current rating:1A AC,DC
- Voltage rating:150V AC,DC
- Temperature range:-40°C~+105°C
- Contact resistance:30mΩMax.
- Insulation resistance:500MΩMin.
- Withstanding voltage:500V AC/minute
- *Compliant with RoHS and REACH*
- *Meet the HF/Halogen Free,need to customize*
- *Contact CJT for details*

Standards



Assembly layout

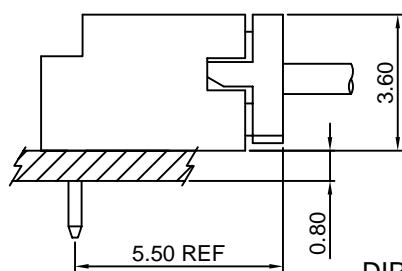

DIP TYPE

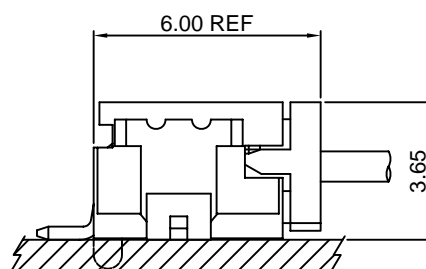
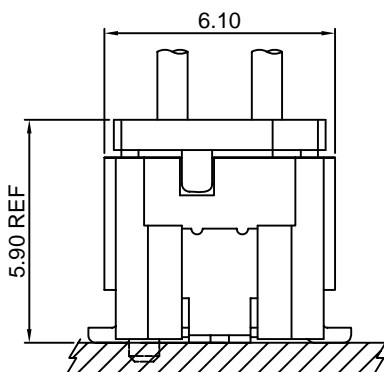
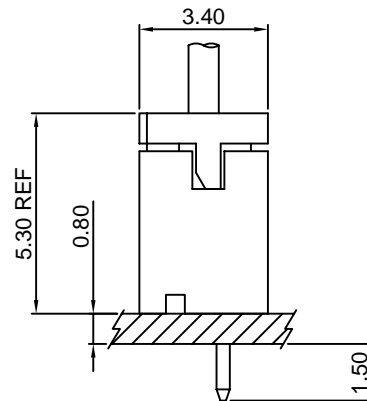

SMT TYPE

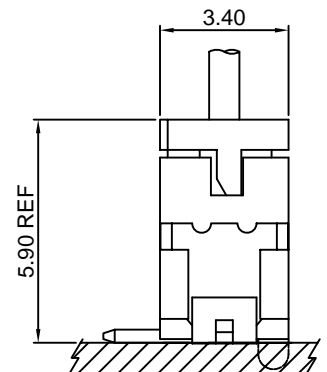

A1252-T

1.25mm pitch Crimp Terminal

Reference Informations:

*Used in CJT A1252H-XP, A1252HA-XP series Housing

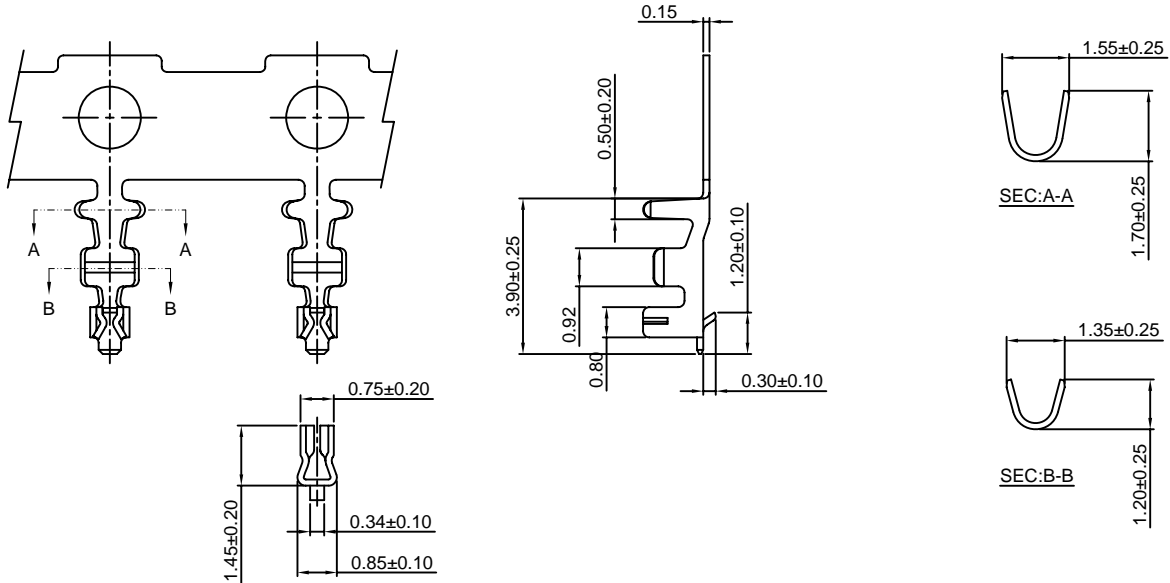

Ordering information & Specifications:

Unit:mm

Part NO.	Wire Range	Insulation O.D.	Material	Finish	Qty/reel
A1252-TP	AWG#26-#30	1.00mm(max)	Phosphor Bronze	Tin over Nickel	10,000 PCS
A1252-GP	AWG#26-#30	1.00mm(max)	Phosphor Bronze	Gold over Nickel	10,000 PCS

Optional Gold plating available but MOQ requested

A1252H-XP

1.25mm pitch Single Row Housing

Reference Informations:

*Material:Nylon 66,UL94V-0

*Suitable CJT A1252-T series Terminal

*Mates with CJT A1252WV,WR,WV-S,WV-S-F,WR-S,WR-S-F-XP series Single Row Wafer

*Color:Gray

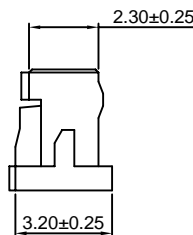
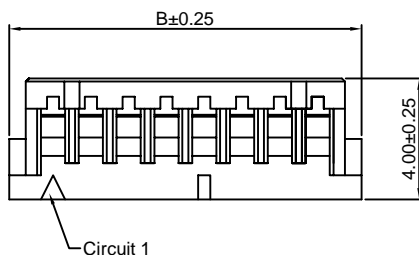
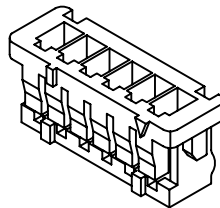
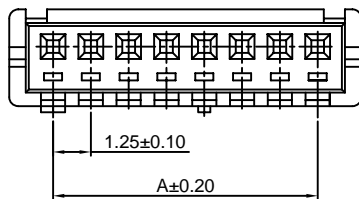

Ordering Information:

A1252H-XP - ***
1 2

1.Part No.

2.Material:

(Blank):Nylon 66,UL94V-0

GWT :Nylon 66,UL94V-0 GWT 750 °C

Ordering Information & Dimensions:

PART NO.	Dimensions	
	A	B
2P	1.25	4.15
3P	2.50	5.40
4P	3.75	6.65
5P	5.00	7.90
6P	6.25	9.15
7P	7.50	10.40
8P	8.75	11.65
9P	10.00	12.90
10P	11.25	14.15
11P	12.50	15.40
12P	13.75	16.65
13P	15.00	17.90
14P	16.25	19.15
15P	17.50	20.40

Unit: mm

A1252HA-XP

1.25mm pitch Single Row Housing

Reference Informations:

- *Material:Nylon 66,UL94V-0
- *Suitable CJT A1252-T series Terminal
- *Color:White

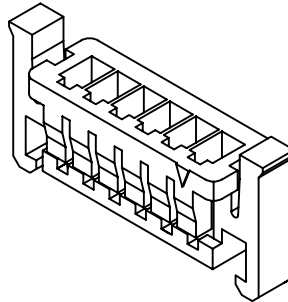
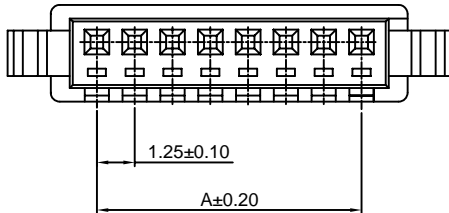

Ordering Information:

A1252HA-XP - ***
1 2

- 1.Part No.
- 2.Material:
(Blank):Nylon 66,UL94V-0
GWT :Nylon 66,UL94V-0 GWT 750 °C

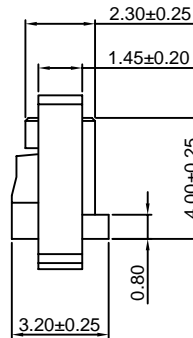
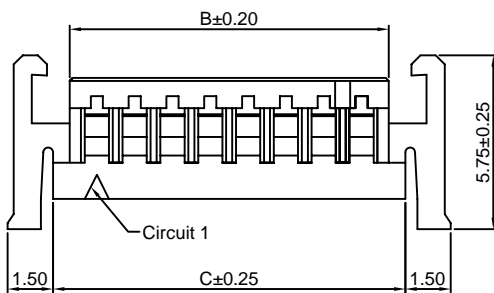

Ordering Information & Dimensions:

PART NO.	Dimensions		
	A	B	C
2P	1.25	2.90	4.15
3P	2.50	4.15	5.40
4P	3.75	5.40	6.65
5P	5.00	6.65	7.90
6P	6.25	7.90	9.15
7P	7.50	9.15	10.40
8P	8.75	10.40	11.65
9P	10.00	11.65	12.90
10P	11.25	12.90	14.15
11P	12.50	14.15	15.40
12P	13.75	15.40	16.65
13P	15.00	16.65	17.90
14P	16.25	17.90	19.15
15P	17.50	19.15	20.40

Unit: mm

A1252H-2xXP

1.25mm pitch Dual Row Housing

Reference Informations:

- *Material:Nylon 66,UL94V-0
- *Suitable CJT A1252-T series Terminal
- *Mates with CJT A1252WV-S,WV-S-F-2xXP series Dual Row Wafer
- *Color:Gray

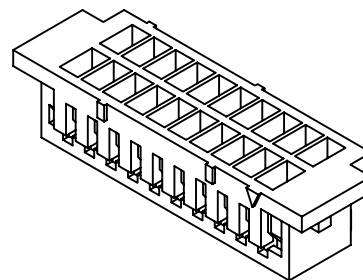
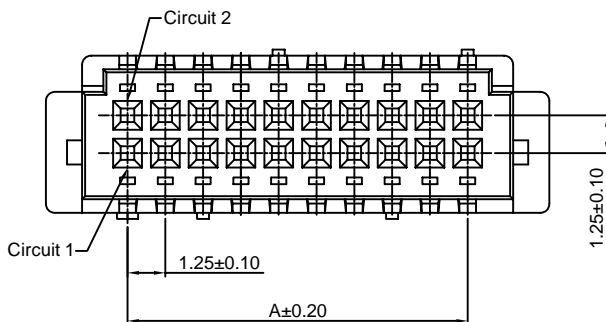

Ordering Information:

A1252H-2xXP - ***
1 2

- 1.Part No.
- 2.Material:
(Blank):Nylon 66,UL94V-0
GWT :Nylon 66,UL94V-0 GWT 750 °C

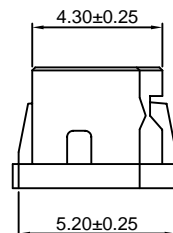
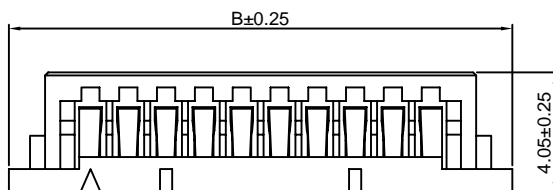

Ordering Information & Dimensions:

PART NO.	Dimensions	
	A	B
2x5P	5.00	10.40
2x7P	7.50	12.90
2x10P	11.25	16.65
2x15P	17.50	22.90
2x20P	23.75	29.15

Unit: mm

A1252WV-XP

1.25mm pitch 180° Single Row Wafer

Reference Informations:

- *Material:Pin:Brass/Tin over Nickel
Insulator:Nylon 66,UL94V-0
- *Mates with CJT A1252H-XP series Single Row Housing
- *Color:Gray

Ordering Information:

A1252WV-XP - *** - **
1 2 3

- 1.Part No.
- 2.Material:
(Blank):Nylon 66,UL94V-0
GWT:Nylon 66,UL94V-0,GWT 750°C
- 3.Finish:
(Blank):Tin over Nickel
G:Gold over Nickel

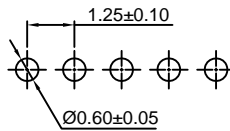
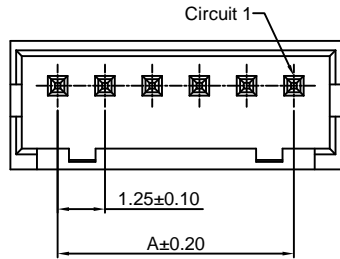
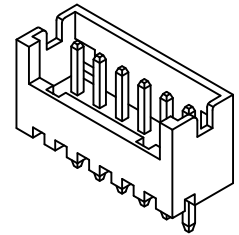

P.C.B LAYOUT

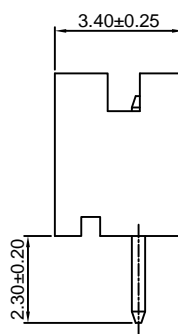
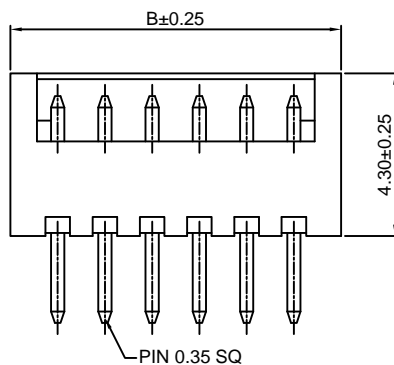

Ordering Information & Dimensions:

PART NO.	Dimensions	
	A	B
2P	1.25	3.75
3P	2.50	5.00
4P	3.75	6.25
5P	5.00	7.50
6P	6.25	8.75
7P	7.50	10.00
8P	8.75	11.25
9P	10.00	12.50
10P	11.25	13.75
11P	12.50	15.00
12P	13.75	16.25
13P	15.00	17.50
14P	16.25	18.75
15P	17.50	20.00

Unit: mm

A1252WR-XP

1.25mm pitch 90° Single Row Wafer

Reference Informations:

- *Material:Pin:Brass/Tin over Nickel
Insulator:Nylon 66,UL94V-0
- *Mates with CJT A1252H-XP series Single Row Housing
- *Color:Gray

Ordering Information:

A1252WR-XP - *** - **
1 2 3

- 1.Part No.
- 2.Material:
(Blank):Nylon 66,UL94V-0
GWT:Nylon 66,UL94V-0,GWT 750°C
- 3.Finish:
(Blank):Tin over Nickel
G:Gold over Nickel

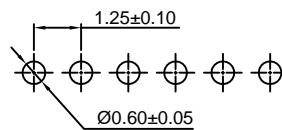
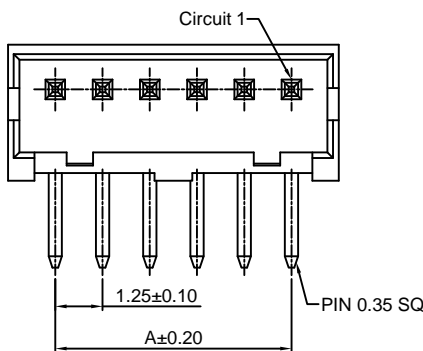
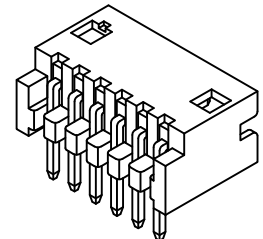

P.C.B LAYOUT

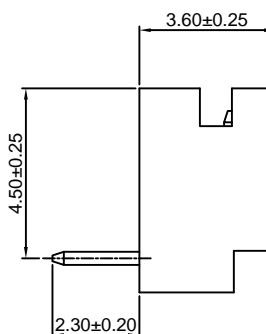
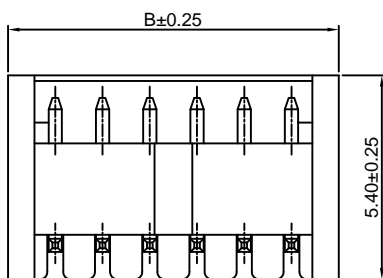

Ordering Information & Dimensions:

PART NO.	Dimensions	
	A	B
2P	1.25	3.75
3P	2.50	5.00
4P	3.75	6.25
5P	5.00	7.50
6P	6.25	8.75
7P	7.50	10.00
8P	8.75	11.25
9P	10.00	12.50
10P	11.25	13.75
11P	12.50	15.00
12P	13.75	16.25
13P	15.00	17.50
14P	16.25	18.75
15P	17.50	20.00

Unit: mm

A1252WV-S-XP

1.25mm pitch 180° Single Row Wafer-SMT TYPE

Reference Informations:

- *Material: Pin: Brass/Tin over Nickel
Insulator: Nylon 6T, UL94V-0
Cap: Nylon 6T, UL94V-0
- *Mates with CJT A1252H-XP series Single Row Housing
- *Color: Ivory

Ordering Information:

A1252WV-S-XP - *** - **
1 2 3

1. Part No.
2. Material:
(Blank): Nylon 6T, UL94V-0
GWT: Nylon 6T, UL94V-0, GWT 750°C
3. Finish:
(Blank): Tin over Nickel
G: Gold over Nickel

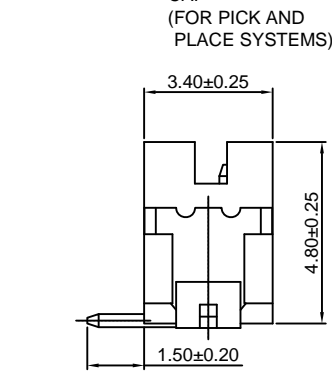
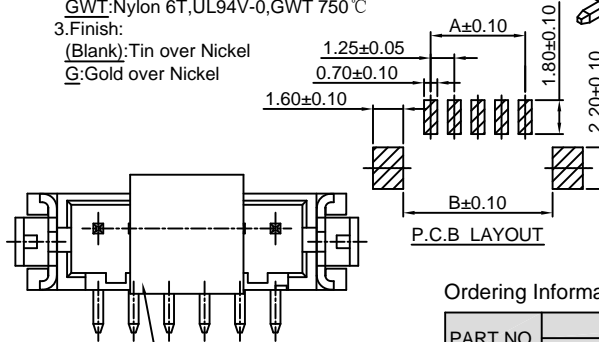
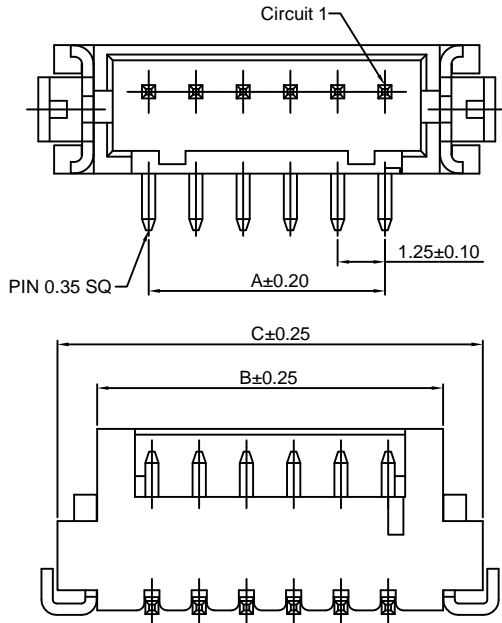
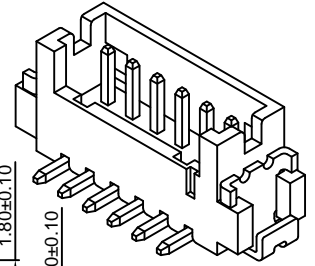

Ordering Information & Dimensions:

PART NO.	Dimensions		
	A	B	C
2P	1.25	4.15	6.25
3P	2.50	5.40	7.50
4P	3.75	6.65	8.75
5P	5.00	7.90	10.00
6P	6.25	9.15	11.25
7P	7.50	10.40	12.50
8P	8.75	11.65	13.75
9P	10.00	12.90	15.00
10P	11.25	14.15	16.25
11P	12.50	15.40	17.50
12P	13.75	16.65	18.75
13P	15.00	17.90	20.00
14P	16.25	19.15	21.25
15P	17.50	20.40	22.50

Unit: mm

A1252WV-S-F-XP

1.25mm pitch 180° Single Row Wafer-SMT TYPE

Reference Informations:

- *Material: Pin: Brass/Tin over Nickel
Solder Tabs: Phosphor Bronze/Tin over Nickel
Insulator: Nylon 6T, UL94V-0
Cap: Nylon 6T, UL94V-0
- *Mates with CJT A1252H-XP series Single Row Housing
- *Color: Ivory

Ordering Information:

A1252WV-S-F-XP - *** - **
1 2 3

1. Part No.
2. Material:
(Blank): Nylon 6T, UL94V-0
GWT: Nylon 6T, UL94V-0, GWT 750°C
3. Finish:
(Blank): Tin over Nickel
G: Gold over Nickel

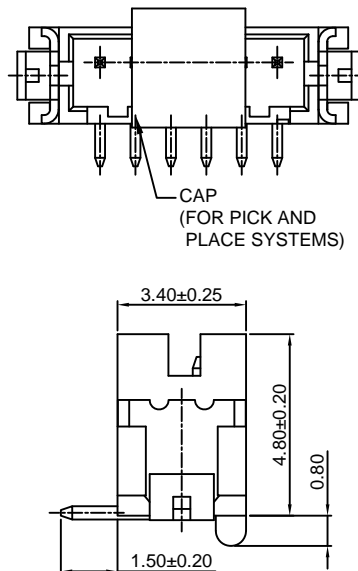
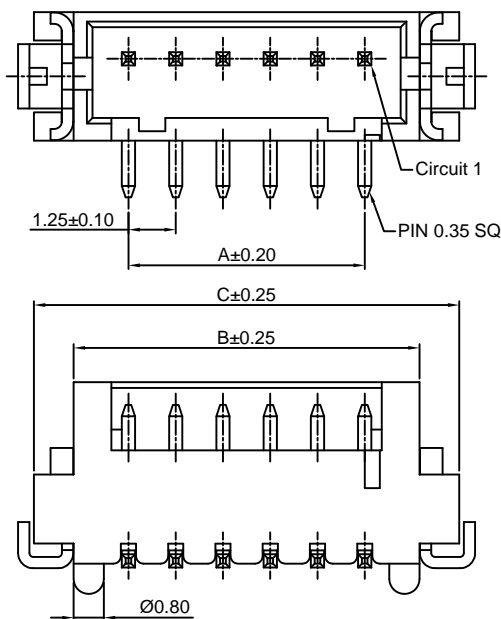
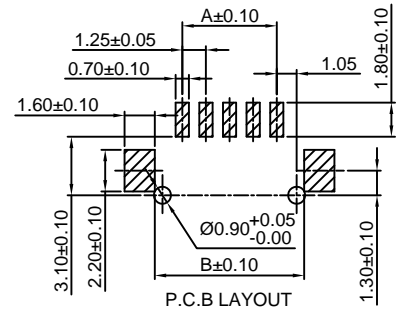

Ordering Information & Dimensions:

PART NO.	Dimensions		
	A	B	C
2P	1.25	4.15	6.25
3P	2.50	5.40	7.50
4P	3.75	6.65	8.75
5P	5.00	7.90	10.00
6P	6.25	9.15	11.25
7P	7.50	10.40	12.50
8P	8.75	11.65	13.75
9P	10.00	12.90	15.00
10P	11.25	14.15	16.25
11P	12.50	15.40	17.50
12P	13.75	16.65	18.75
13P	15.00	17.90	20.00
14P	16.25	19.15	21.25
15P	17.50	20.40	22.50

Unit: mm

A1252WR-S-XP

1.25mm pitch 90° Single Row Wafer-SMT TYPE

Reference Informations:

- *Material: Pin: Brass/Tin over Nickel
Solder Tabs: Phosphor Bronze/Tin over Nickel
Insulator: Nylon 6T, UL94V-0
- *Mates with CJT A1252H-XP series Single Row Housing
- *Color: Ivory

Ordering Information:

A1252WR-S-XP - *** - **
1 2 3

1. Part No.
2. Material:
(Blank): Nylon 6T, UL94V-0
GWT: Nylon 6T, UL94V-0 GWT 750°C
3. Finish:
(Blank): Tin over Nickel
G: Gold over Nickel

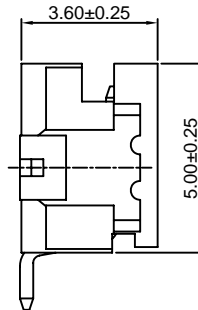
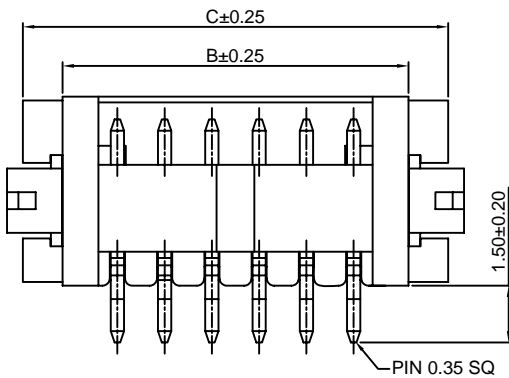
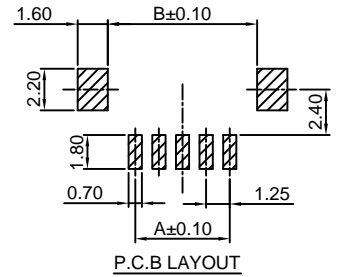
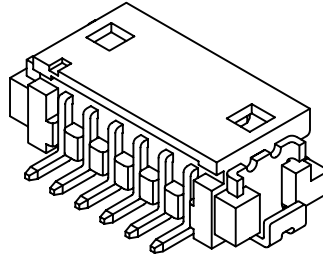
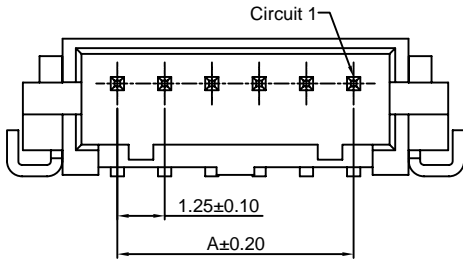

Ordering Information & Dimensions:

PART NO.	Dimensions		
	A	B	C
2P	1.25	4.15	6.25
3P	2.50	5.40	7.50
4P	3.75	6.65	8.75
5P	5.00	7.90	10.00
6P	6.25	9.15	11.25
7P	7.50	10.40	12.50
8P	8.75	11.65	13.75
9P	10.00	12.90	15.00
10P	11.25	14.15	16.25
11P	12.50	15.40	17.50
12P	13.75	16.65	18.75
13P	15.00	17.90	20.00
14P	16.25	19.15	21.25
15P	17.50	20.40	22.50

Unit: mm

A1252WR-S-F-XP

1.25mm pitch 90° Single Row Wafer-SMT TYPE

Reference Informations:

- *Material: Pin: Brass/Tin over Nickel
Solder Tabs: Phosphor Bronze/Tin over Nickel
Insulator: Nylon 6T, UL94V-0
- *Mates with CJT A1252H-XP series Single Row Housing
- *Color: Ivory

Ordering Information:

A1252WR-S-F-XP - *** - **
1 2 3

1. Part No.
2. Material:
(Blank): Nylon 6T, UL94V-0
GWT: Nylon 6T, UL94V-0 GWT 750°C
3. Finish:
(Blank): Tin over Nickel
G: Gold over Nickel

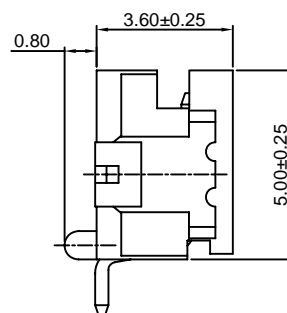
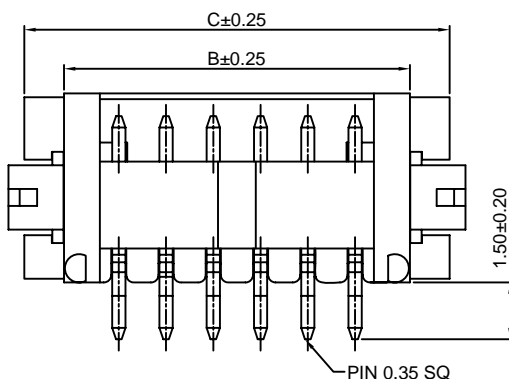
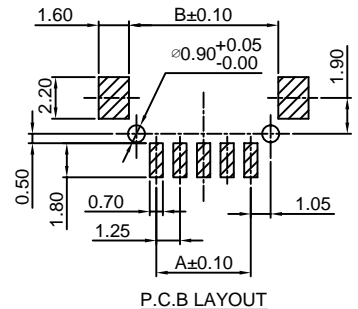
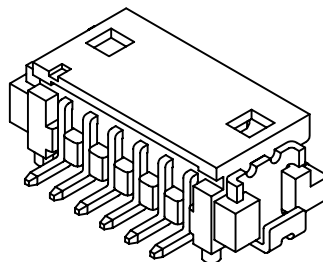
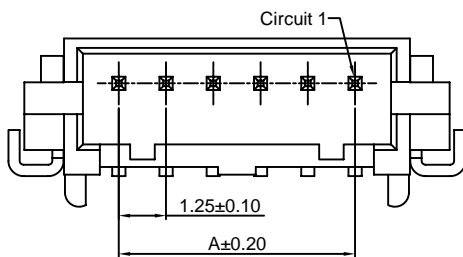

Ordering Information & Dimensions:

PART NO.	Dimensions		
	A	B	C
2P	1.25	4.15	6.25
3P	2.50	5.40	7.50
4P	3.75	6.65	8.75
5P	5.00	7.90	10.00
6P	6.25	9.15	11.25
7P	7.50	10.40	12.50
8P	8.75	11.65	13.75
9P	10.00	12.90	15.00
10P	11.25	14.15	16.25
11P	12.50	15.40	17.50
12P	13.75	16.65	18.75
13P	15.00	17.90	20.00
14P	16.25	19.15	21.25
15P	17.50	20.40	22.50

Unit: mm

A1252WV-S-2xXP

1.25mm pitch 180° Dual Row Wafer-SMT TYPE

Reference Informations:

- *Material:Pin:Brass/Tin over Nickel
Solder Tabs:Phosphor Bronze/Tin over Nickel
Insulator:Nylon 6T,UL94V-0
Cap:Nylon 6T,UL94V-0
- *Mates with CJT A1252H-2xXP series Dual Row Housing
- *Color:Ivory

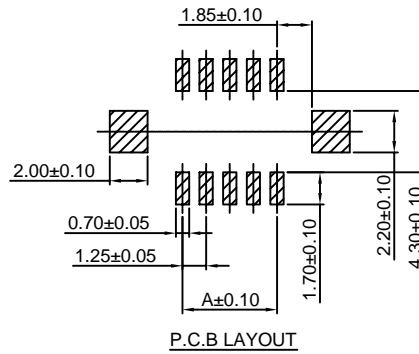
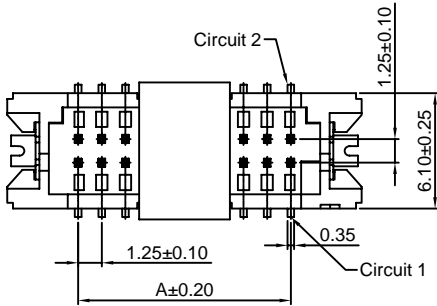
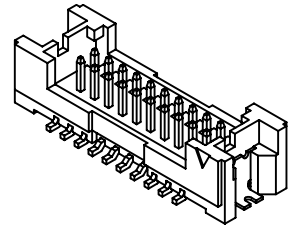

Ordering Information:
A1252WV-S-2xXP - *** - **
1 2 3

- 1.Part No.
- 2.Material:
(Blank):Nylon 6T,UL94V-0
GWT:Nylon 6T,UL94V-0,GWT 750 °C
- 3.Finish:
(Blank):Tin over Nickel
G:Gold over Nickel

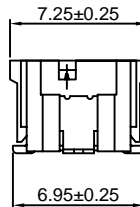
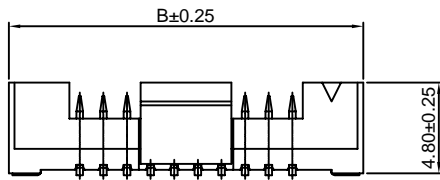

Ordering Information & Dimensions:

PART NO.	Dimensions	
	A	B
2x5P	5.00	12.50
2x7P	7.50	15.00
2x10P	11.25	18.75
2x15P	17.50	25.00
2x20P	23.75	31.25

Unit: mm

A1252WV-S-F-2xXP

1.25mm pitch 180° Dual Row Wafer-SMT TYPE

Reference Informations:

- *Material:Pin:Brass/Tin over Nickel
Solder Tabs:Phosphor Bronze/Tin over Nickel
Insulator:Nylon 6T,UL94V-0
Cap:Nylon 6T,UL94V-0
- *Mates with CJT A1252H-2xXP series Dual Row Housing
- *Color:Ivory

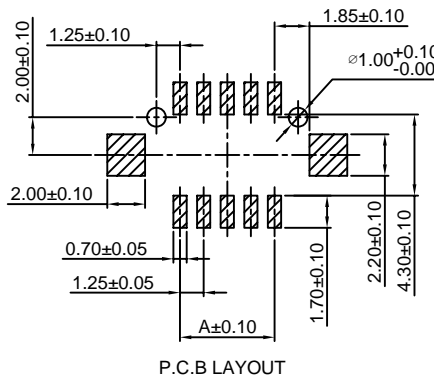
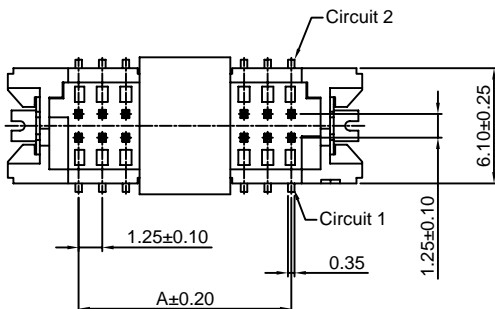
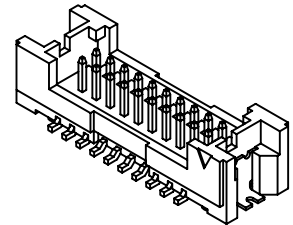

Ordering Information:
A1252WV-S-F-2xXP - *** - **
1 2 3

- 1.Part No.
- 2.Material:
(Blank):Nylon 6T,UL94V-0
GWT:Nylon 6T,UL94V-0,GWT 750 °C
- 3.Finish:
(Blank):Tin over Nickel
G:Gold over Nickel

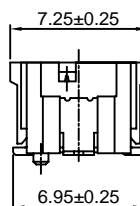
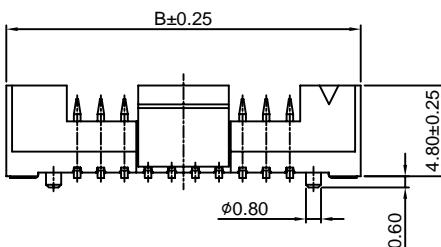

Ordering Information & Dimensions:

PART NO.	Dimensions	
	A	B
2x5P	5.00	12.50
2x7P	7.50	15.00
2x10P	11.25	18.75
2x15P	17.50	25.00
2x20P	23.75	31.25

Unit: mm

X-ON Electronics

Largest Supplier of Electrical and Electronic Components

Click to view similar products for [Headers & Wire Housings](#) category:

Click to view products by [Changjiang](#) manufacturer:

Other Similar products are found below :

[95000-104TRLF](#) [10135584-644402LF](#) [DF62W-EP2022PCA](#) [95000-106TRLF](#) [DF62W-2022SCA](#) [DF62W-EP2022PC](#) [2203348](#) [DF62W-2022SC](#) [1084018](#) [1029039](#) [1084017](#) [802-10-012-10-002000](#) [1112640](#) [1112639](#) [891-007-9SS-BST1T](#) [000-34000](#) [0008550134](#) [0009482033](#) [0009507031](#) [57102-F02-18ULF](#) [57102-S06-03LF](#) [57202-S52-04LF](#) [PCN6-15S-2.5E](#) [0039019024](#) [58102-G61-06LF](#) [582553-1](#) [0009485154](#) [0009508121](#) [0022285053](#) [0050291907](#) [018731A](#) [LY20-4P-DT1-P1E-BR](#) [02.125.8002.8](#) [60101931](#) [60598-1 \(Cut Strip\)](#) [M1625-3R/100](#) [61062-3](#) [61082-181009](#) [CSU011177004](#) [636-1427](#) [638009-1](#) [641938-9](#) [641991-4](#) [644168-1](#) [644827-2](#) [647662-1](#) [65039-019ELF](#) [65692-001LF](#) [65781-018](#) [65781-047](#)