

## Specifications

- Current rating:1A AC,DC
- Voltage rating:150V AC,DC
- Temperature range:-40°C~+105°C
- Contact resistance:30mΩMax.
- Insulation resistance:500MΩMin.
- Withstanding voltage:500V AC/minute
- \*Compliant with RoHS and REACH\*
- \*Meet the HF/Halogen Free,need to customize\*
- \*Contact CJT for details\*

## Standards

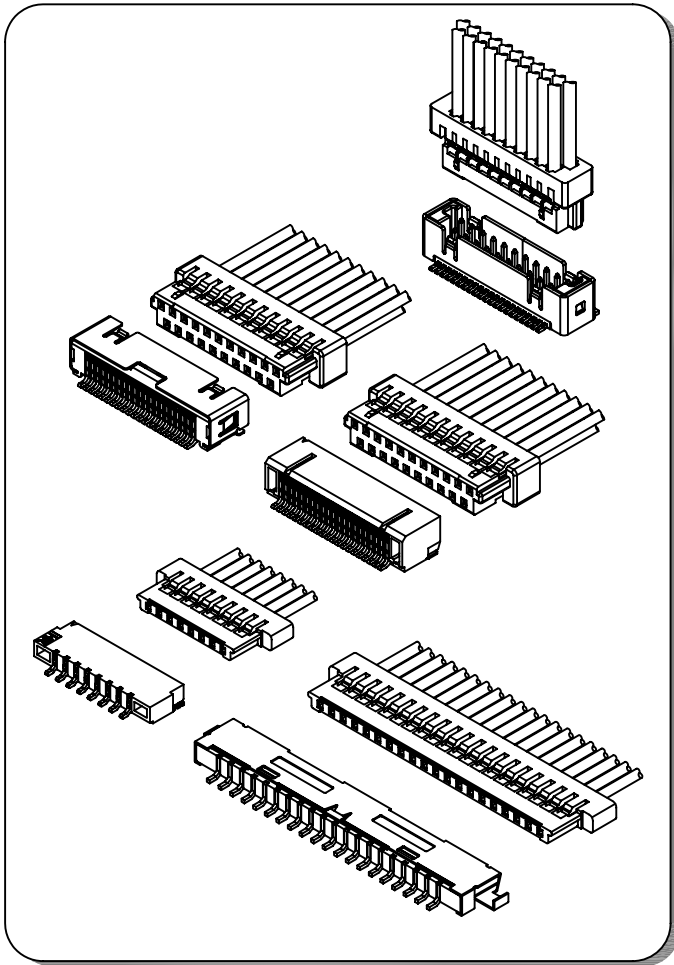

## Assembly layout

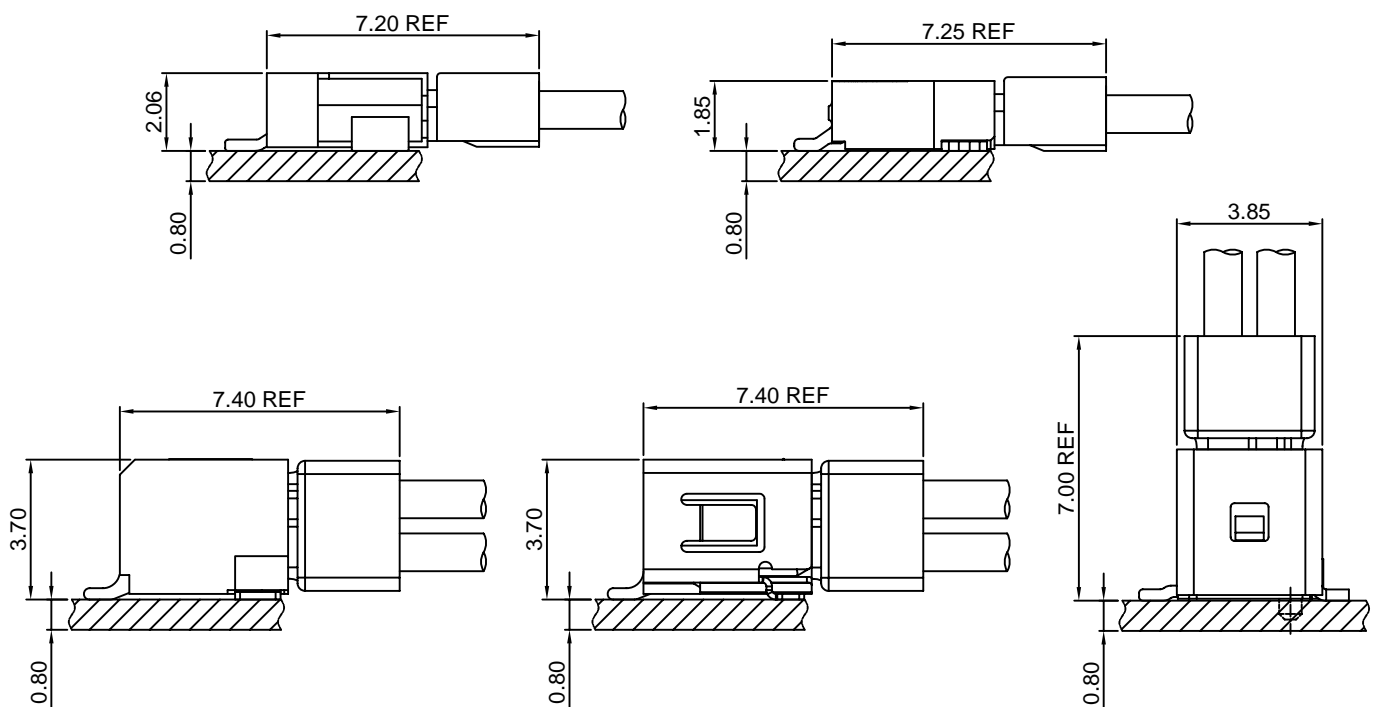

# A1256-T

1.25mm pitch Crimp Terminal

#### Reference Informations:

\*Used in CJT A1256H,HD-XP,A1255HA-XP series Housing

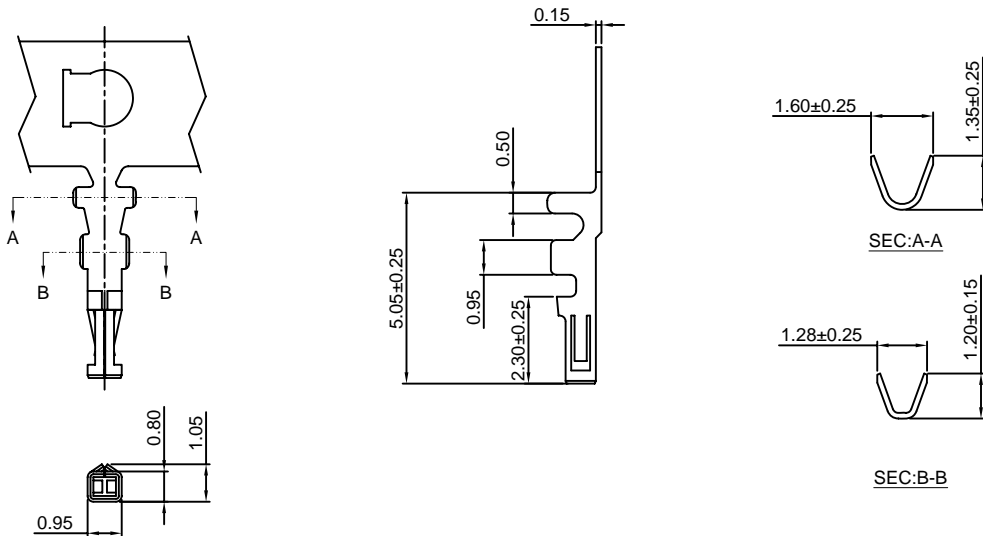

Ordering information & Specifications:

Unit:mm

| Part NO  | Wire Range | Insulation O.D. | Material        | Finish           | Qty/reel   |
|----------|------------|-----------------|-----------------|------------------|------------|
| A1256-TP | AWG#28-#32 | 0.90mm(max)     | Phosphor Bronze | Tin over Nickel  | 15,000 PCS |
| A1256-GP | AWG#28-#32 | 0.90mm(max)     | Phosphor Bronze | Gold over Nickel | 15,000 PCS |

Optional Gold plating available but MOQ requested

# A1256H-XP

1.25mm pitch Housing

#### Reference Informations:

\*Material:Nylon 66,UL94V-0

\*Suitable CJT A1256-T series Terminal

\*Mates with CJT A1256WR-S,WRA-S-XP series Wafer

\*Color:Black

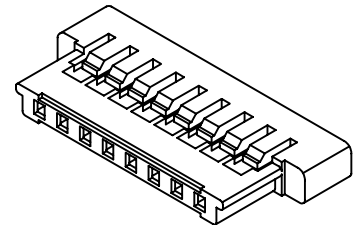

#### Ordering Information:

A1256H-XP - \*\*\*  
1 2

1.Part No.

2.Material:

(Blank):Nylon 66,UL94V-0

GWT:Nylon 66,UL94V-0,GWT 750°C

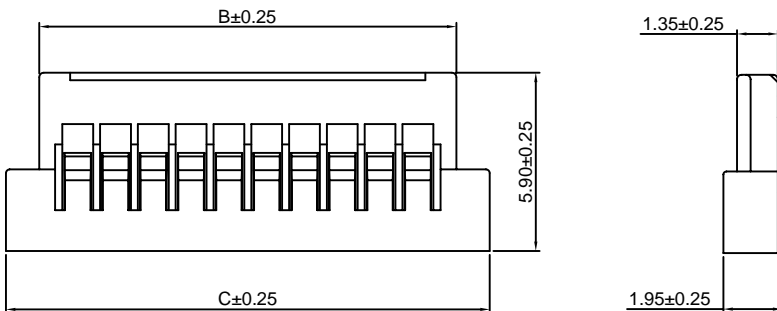
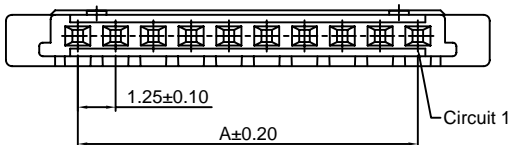

#### Ordering Information & Dimensions:

| PART NO. | Dimensions |       |       |
|----------|------------|-------|-------|
|          | A          | B     | C     |
| 2P       | 1.25       | 3.80  | 6.00  |
| 3P       | 2.50       | 5.05  | 7.25  |
| 4P       | 3.75       | 6.30  | 8.50  |
| 5P       | 5.00       | 7.55  | 9.75  |
| 6P       | 6.25       | 8.80  | 11.00 |
| 8P       | 8.75       | 11.30 | 13.50 |
| 10P      | 11.25      | 13.80 | 16.00 |
| 15P      | 17.25      | 20.05 | 22.25 |
| 20P      | 23.75      | 26.30 | 28.50 |
| 25P      | 30.00      | 32.55 | 34.75 |
| 30P      | 36.25      | 38.80 | 41.00 |

Unit: mm

### A1256HD-XP

1.25mm pitch Dual Row Housing

**Reference Informations:**

- \*Material:Nylon 66,UL94V-0
- \*Suitable CJT A1256-T series Terminal
- \*Mates with CJT A1256WVD-S-F, WRD-S, WRDA-S-XP series Dual Row Wafer
- \*Color:Black

**Ordering Information:**

- A1256HD-XP - \*\*\*  
 1 2  
 1.Part No.  
 2.Material:  
 (Blank):Nylon 66,UL94V-0  
 GWT:Nylon 66,UL94V-0,GWT 750 °C

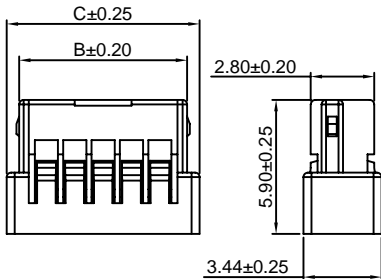
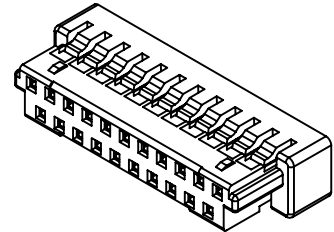
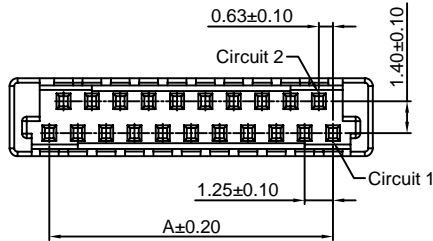
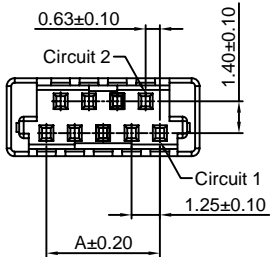

5,7,9,11 Contacts

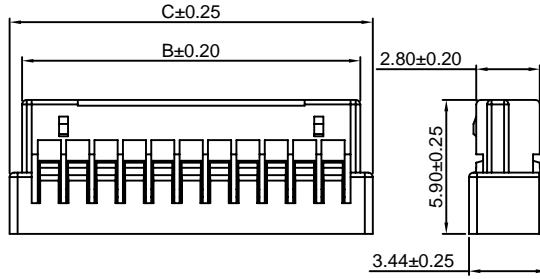

13,15,17,19,21,31,41 Contacts

**Ordering Information & Dimensions:**

| PART NO. | Dimensions |       |       |
|----------|------------|-------|-------|
|          | A          | B     | C     |
| 5P       | 2.50       | 4.90  | 6.00  |
| 7P       | 3.75       | 6.15  | 7.25  |
| 9P       | 5.00       | 7.40  | 8.50  |
| 11P      | 6.25       | 8.65  | 9.75  |
| 13P      | 7.50       | 9.90  | 11.00 |
| 15P      | 8.75       | 11.15 | 12.25 |
| 17P      | 10.00      | 12.40 | 13.50 |
| 19P      | 11.25      | 13.65 | 14.75 |
| 21P      | 12.50      | 14.90 | 16.00 |
| 31P      | 18.75      | 21.15 | 22.25 |
| 41P      | 25.00      | 27.60 | 28.50 |

Unit: mm

### A1256WR-S-XP

1.25mm pitch 90° Wafer-SMT TYPE

**Reference Informations:**

- \*Material:Pin:Brass/Gold over Nickel  
Solder Tabs:Brass/Tin over Nickel  
Insulator:Nylon 6T,UL94V-0
- \*Mates with CJT A1256H-XP series Housing
- \*Color:White

**Ordering Information:**

- A1256WR-S-XP - \*\*\*  
 1 2  
 1.Part No.  
 2.Material:  
 (Blank):Nylon 6T,UL94V-0  
 GWT:Nylon 6T,UL94V-0,GWT 750 °C

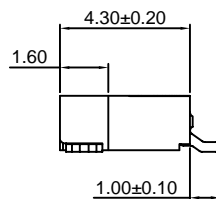
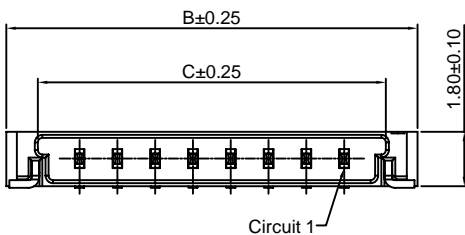
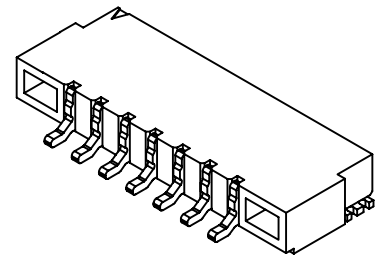
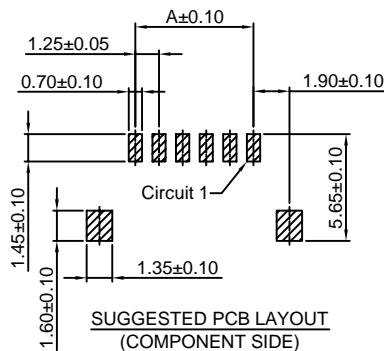
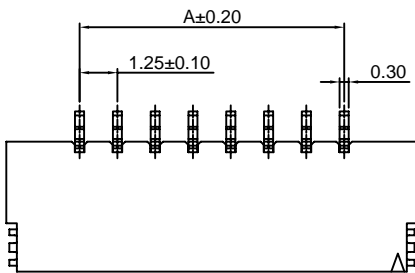

**Ordering Information & Dimensions:**

| PART NO. | Dimensions |       |       |
|----------|------------|-------|-------|
|          | A          | B     | C     |
| 2P       | 1.25       | 6.10  | 4.01  |
| 3P       | 2.50       | 7.35  | 5.26  |
| 4P       | 3.75       | 8.60  | 6.51  |
| 5P       | 5.00       | 9.85  | 7.76  |
| 6P       | 6.25       | 11.10 | 9.01  |
| 8P       | 8.75       | 13.60 | 11.51 |
| 10P      | 11.25      | 16.10 | 14.01 |
| 15P      | 17.25      | 22.35 | 20.26 |
| 20P      | 23.75      | 28.60 | 26.51 |
| 25P      | 30.00      | 34.85 | 32.76 |
| 30P      | 36.25      | 41.10 | 39.01 |

Unit: mm



### A1256WRD-S-XP

1.25mm Pitch 90° Dual Row Wafer-SMT TYPE

**Reference Informations:**

- \*Material: Pin: Brass/Gold over Nickel  
Shell: Brass/Tin over Nickel  
Insulator: Nylon 6T, UL94V-0
- \*Mates with CJT A1256HD-XP series Dual Row Housing
- \*Color: White

Ordering Information:  
A1256WRD-S-XP - \*\*\*  
 1 2  
 1. Part No.  
 2. Material:  
 (Blank): Nylon 6T, UL94V-0  
 GWT: Nylon 6T, UL94V-0, GWT 750 °C

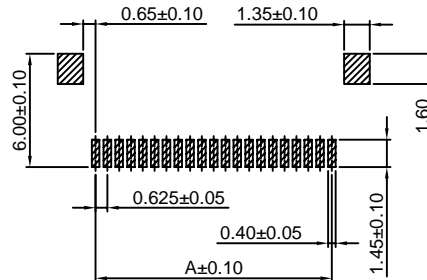
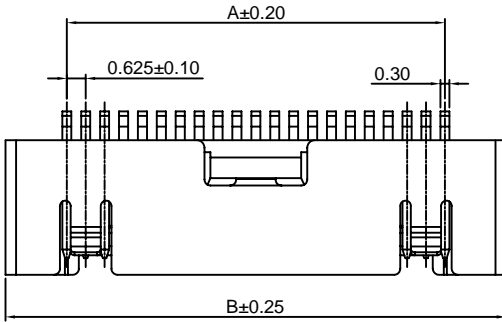
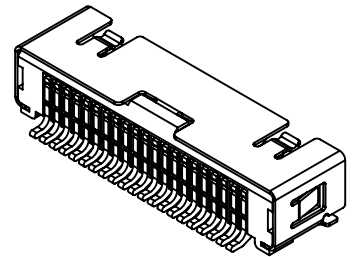

SUGGESTED PCB LAYOUT  
(COMPONENT SIDE)

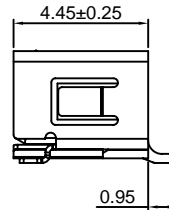
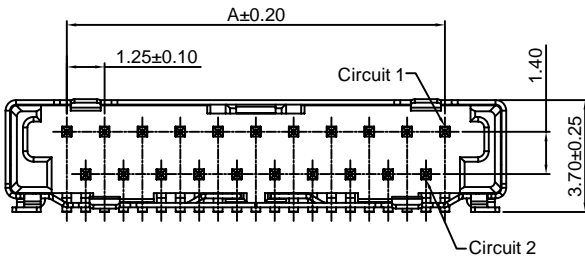

Ordering Information & Dimensions:

| PART NO. | Dimensions |       |
|----------|------------|-------|
|          | A          | B     |
| 21P      | 12.50      | 16.55 |
| 31P      | 18.75      | 22.80 |
| 41P      | 25.00      | 29.05 |

Unit: mm

### A1256WRDA-S-XP

1.25mm pitch 90° Dual Row Wafer-SMT TYPE

**Reference Informations:**

- \*Material: Pin: Brass/Gold over Nickel  
Solder Tabs: Brass/Tin over Nickel  
Insulator: Nylon 6T, UL94V-0
- \*Mates with CJT A1256HD-XP series dual row Housing
- \*Color: White

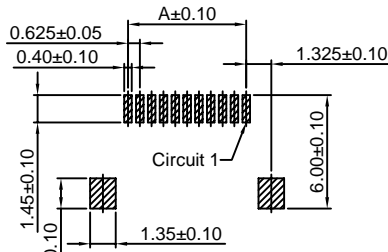

Ordering Information:  
A1256WRDA-S-XP - \*\*\*  
 1 2  
 1. Part No.  
 2. Material:  
 (Blank): Nylon 6T, UL94V-0  
 GWT: Nylon 6T, UL94V-0, GWT 750 °C

SUGGESTED PCB LAYOUT  
(COMPONENT SIDE)

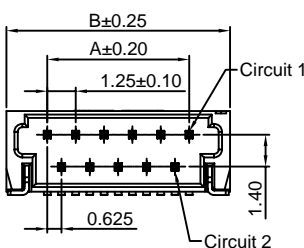
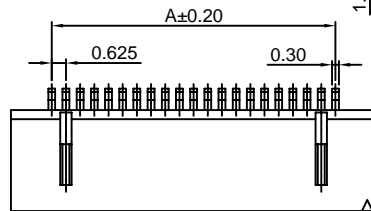
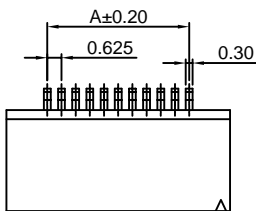

5,7,9,11 Contacts

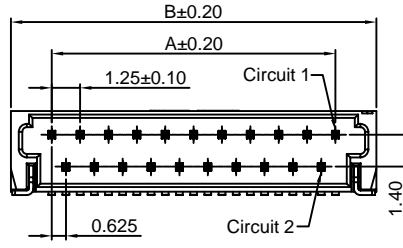

13,15,17,19,21,31,41 Contacts

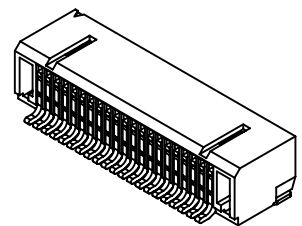
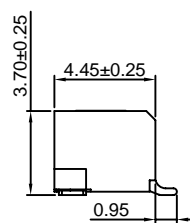

Ordering Information & Dimensions:

| PART NO. | Dimensions |       |
|----------|------------|-------|
|          | A          | B     |
| 5P       | 2.50       | 6.10  |
| 7P       | 3.75       | 7.35  |
| 9P       | 5.00       | 8.60  |
| 11P      | 6.25       | 9.85  |
| 13P      | 7.50       | 11.10 |
| 15P      | 8.75       | 12.35 |
| 17P      | 10.00      | 13.60 |
| 19P      | 11.25      | 14.85 |
| 21P      | 12.50      | 16.10 |
| 31P      | 18.75      | 22.35 |
| 41P      | 25.00      | 28.60 |

Unit: mm

## X-ON Electronics

Largest Supplier of Electrical and Electronic Components

*Click to view similar products for [Headers & Wire Housings](#) category:*

*Click to view products by [Changjiang](#) manufacturer:*

Other Similar products are found below :

[95000-104TRLF](#) [10135584-644402LF](#) [DF62W-EP2022PCA](#) [95000-106TRLF](#) [DF62W-2022SCA](#) [DF62W-EP2022PC](#) [2203348](#) [DF62W-2022SC](#) [1084018](#) [1029039](#) [1084017](#) [802-10-012-10-002000](#) [1112640](#) [1112639](#) [891-007-9SS-BST1T](#) [000-34000](#) [0008550134](#) [0009482033](#) [0009507031](#) [57102-F02-18ULF](#) [57102-S06-03LF](#) [57202-S52-04LF](#) [PCN6-15S-2.5E](#) [0039019024](#) [58102-G61-06LF](#) [582553-1](#) [0009485154](#) [0009508121](#) [0022285053](#) [0050291907](#) [018731A](#) [LY20-4P-DT1-P1E-BR](#) [02.125.8002.8](#) [60101931](#) [60598-1 \(Cut Strip\)](#) [M1625-3R/100](#) [61062-3](#) [61082-181009](#) [CSU011177004](#) [636-1427](#) [638009-1](#) [641938-9](#) [641991-4](#) [644168-1](#) [644827-2](#) [647662-1](#) [65039-019ELF](#) [65692-001LF](#) [65781-018](#) [65781-047](#)