



ORIENT

Photocoupler

Product Data Sheet

Name: ORPC-6N137

Customer: _____

Date: _____

SHENZHEN ORIENT TECHNOLOGY CO.,LTD.

Block A 3rd Floor No.4 Building, Tian'an Cyber Park, Huangge Rd, LongGang
Dist, Shenzhen, GD

TEL: 0755-29681816

FAX: 0755-29681200

www.orient-opto.com

1、 Features

- (1) 3.3v / 5V supply voltage
- (2) low power consumption
- (3) high speed: 15MBd(typical)
- (4) VCM=1000V, and the lowest common mode inhibition (CMR) is 10 kv/μs
- (5) when - 40 °C ~ + 85 °C temperature of ac and dc performance

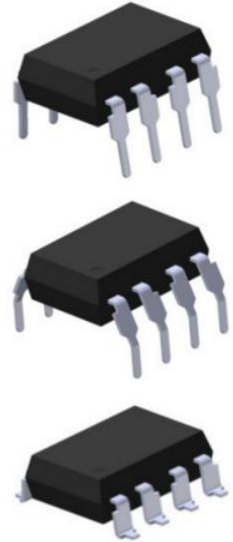

2、 Instructions

6N137 is made up of an efficient AlGaAs light-emitting diode and high-speed optical detector. This design provides good ac and dc isolation between the input and output ends of the photoelectric coupler. The output characteristic of the photodetector is a collector open circuit schottky clamp transistor. The total mode transient immunity should reach 10 kv/pa at 3.3 v.

The photoelectric coupler operating temperature range: - 40 °C ~ + 85 °C.

3、 Application Range

- line receiver isolation
- A/ D, D/A converted digital signal isolation
- eliminate noise from the ground loop
- switching power supply
- alternative pulse transformers
- motor control system
- interface of microprocessor system, computer and peripheral equipment

4、 Functional Diagram

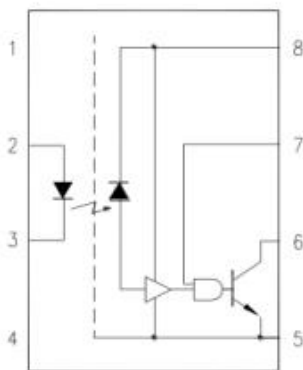

- 1.NC
- 2.Anode
- 3.Cathode
- 4.NC
- 5.GND
- 6.Output
- 7.VE(Enable)
- 8.Vcc

Truth table

Input(LED)	Enable	Output
ON	H	L
OFF	H	H
ON	L	H
OFF	L	H
ON	NC	L
OFF	NC	H

0.1 capacitor F bypass capacitance needs to be connected between A Pin8 and Pin5

5. Absolute Maximum Ratings (Ta=25°C)*1

Parameter		Symbol	Rated Value	Unit
Input	Average Forward Input Current	I_F	20	mA
	Reverse Input Voltage	V_R	5	V
	Power Dissipation	P_I	40	mW
	Enable Input Voltage	V_E	VCC+0.5	V
	Enable Input current	I_E	5	mA
Output	Output Collector Current	I_O	50	mA
	Output Collector Voltage	V_O	7	V
	Output Collector Power Dissipation	P_O	85	mW
Supply Voltage		V_{CC}	7	V
Insulation Voltage		V_{iso}	5000	Vrms
Working Temperature		T_{opr}	-40 ~ + 85	°C
Storage Temperature		T_{stg}	-55 ~ + 125	
*2	Soldering Temperature	T_{sol}	260	

*1. Room temperature = 25 °C. Exceeding the maximum absolute rating can permanently damage the device.

Working long hours at the maximum absolute rating can affect reliability.

*2. soldering time is 10 seconds.



6、 Recommended Operating Conditions

Parameter	Symbol	Min	Max	Unit
Operating Temperature	T_A	-40	85	°C
Supply Voltage	V_{CC}	2.7	3.6	V
		4.5	5.5	
Low Level Input Current	I_{FL}	0	250	μA
High Level Input Current	I_{FH}	5	15	mA
Low Level Enable Voltage	V_{EL}	0	0.8	V
High Level Enable Voltage	V_{EH}	2	V_{CC}	V
Output Pull-up Resistor	R_L	330	4k	Ω
Fan Out (at $R_L=1k\Omega$ per channel)	N	—	5	TTL Loads

7、 Opto-electronic Characteristics

Parameter	Symbol	Condition	Min	Typ	Max	Unit
Input						
Forward voltage	V_F	$I_F = 10\text{mA}$	—	1.38	1.7	V
Temperature Coefficient OF Forward Voltage	$\Delta V_F / \Delta T$	$I_F = 10\text{mA}$	—	-1.5	—	mV/°C
Reverse Voltage	BV_R	$I_R = 10\mu\text{A}$	5	—	—	V
Input Threshold Current	I_{TH}	$V_E = 2\text{V}, V_{CC} = 3.3\text{V}$ $V_O = 0.6\text{V}$ $I_{OL}(\text{sinking}) = 13\text{mA}$	—	1.5	5	mA
Input Capacitance	C_{IN}	$f = 1\text{MHz}, V_F = 0\text{V}$	—	34	—	pF
Detector						
High Level Supply Current	I_{CCH}	$V_E = 0.5\text{V},$ $V_{CC} = 3.3\text{V}, I_F = 0\text{mA}$	—	3.8	10	μA
Low Level Supply Current	I_{CCL}	$V_E = 0.5\text{V},$ $V_{CC} = 3.3\text{V}, I_F = 10\text{mA}$	—	5.8	13	mA
High Level Enable Current	I_{EH}	$V_{CC} = 3.3\text{V}, V_E = 2\text{V}$	—	-0.19	-1.6	mA
Low Level Enable Current	I_{EL}	$V_{CC} = 3.3\text{V}, V_E = 0.5\text{V}$	—	-0.41	-1.6	mA
High Level Enable Voltage	V_{EH}		2	—	—	V
Low Level Enable Voltage	V_{EL}			—	0.8	V
High Level Output Current	I_{OH}	$V_E = 2\text{V}, V_{CC} = 3.3\text{V},$ $V_O = 3.2\text{V}, I_F = 250\mu\text{A}$	—	5	100	μA
Low Level Output Voltage	V_{OL}	$V_E = 2\text{V}, V_{CC} = 3.3\text{V},$ $I_F = 5\text{mA},$ $I_{OL}(\text{sinking}) = 13\text{mA}$	—	0.3	0.6	V

Recommended temperature range ($T_A = -40^\circ\text{C} \sim +85^\circ\text{C}, 2.7\text{V} \leq V_{CC} \leq 3.6\text{V}$), $I_F = 7.5\text{mA}$ Unless otherwise

stated. Typical values $T_A = 25^\circ\text{C}, V_{CC} = 3.3\text{V}$.

Parameter	Symbol	Condition	Min	Typ	Max	Unit
Input						
Forward voltage	V_F	$I_F = 10\text{mA}$	—	1.38	1.7	V
Temperature Coefficient OF Forward Voltage	$\Delta V_F / \Delta T$	$I_F = 10\text{mA}$	—	-1.5	—	mV/°C
Reverse Voltage	BV_R	$I_R = 10\mu\text{A}$	5	—	—	V
Input Threshold Current	I_{TH}	$V_{CC}=5.5\text{V}, V_O=0.6\text{V}$ $I_{OL}>13\text{mA}$	—	1.35	5	mA
Input Capacitance	C_{IN}	$f = 1\text{MHz}, V_F = 0\text{V}$	—	34	—	pF
Detector						
High Level Supply Current	I_{CCH}	$V_E = 0.5\text{V},$ $V_{CC}=5.5\text{V}, I_F=0\text{mA}$	—	6.1	10	μA
Low Level Supply Current	I_{CCL}	$V_E = 0.5\text{V},$ $V_{CC}= 5.5\text{V}, I_F=10\text{mA}$	—	8.3	13	mA
High Level Enable Current	I_{EH}	$V_{CC}= 5.5\text{V}, V_E=2\text{V}$	—	-0.6	-1.6	mA
Low Level Enable Current	I_{EL}	$V_{CC}= 5.5\text{V}, V_E=0.5\text{V}$	—	-0.9	-1.6	mA
High Level Enable Voltage	V_{EH}		2	—	—	V
Low Level Enable Voltage	V_{EL}			—	0.8	V
High Level Output Current	I_{OH}	$V_E=2\text{V}, V_{CC}=5.5\text{V},$ $V_O=5.5\text{V}, I_F=250\mu\text{A}$	—	0.9	100	μA
Low Level Output Voltage	V_{OL}	$V_E=2\text{V}, V_{CC}=5.5\text{V},$ $I_F=5\text{mA},$ $I_{OL}(\text{sinking}) = 13\text{mA}$	—	0.3	0.6	V

Recommended temperature range($T_A = -40^\circ\text{C} \sim +85^\circ\text{C}, 4.5\text{V} \leq V_{CC} \leq 5.5\text{V}$), $I_F = 7.5\text{mA}$ Unless otherwise stated.

Typical values $T_A = 25^\circ\text{C}, V_{CC} = 5.0\text{V}$.

8、 Switching Characteristics

Parameter	Symbol	Condition	Min	Typ	Max	Unit
Propagation delay time to output High level	t_{PLH}	$R_L=350\Omega$ $C_L=15pF$	25	48	90	ns
Propagation delay time to output Low level	t_{PHL}		25	35	75	ns
Pulse Width Distortion	$ t_{PLH}-t_{PHL} $		—	13	—	ns
Output Rise Time (10 to 90%)	t_r		—	21	—	ns
Output Fall Time (90 to 10%)	t_f		—	6.6	—	ns
Propagation Delay Time of Enable from V_{EH} to V_{EL}	t_{ELH}	$R_L=350\Omega$ $C_L=15pF$	—	27	—	ns
Propagation Delay Time of Enable from V_{EL} to V_{EH}	t_{EHL}	$V_{EL}=0V$ $V_{EH}=3V$	—	9	—	ns

Recommended temperature range ($T_A = -40^\circ C \rightarrow +85^\circ C, 2.7V \leq V_{CC} \leq 3.6V$), $I_F = 7.5mA$ Unless otherwise

stated. Typical values $T_A = 25^\circ C, V_{CC} = 3.3V$.

Parameter	Symbol	Condition	Min	Typ	Max	Unit
Propagation delay time to output High level	t_{PLH}	$T_A=25^\circ C$ $R_L=350\Omega$ $C_L=15pF$	25	40	75	ns
			—	—	100	
Propagation delay time to output Low level	t_{PHL}	$T_A=25^\circ C$ $R_L=350\Omega$ $C_L=15pF$	25	32	75	ns
			—	—	100	
Pulse Width Distortion	$ t_{PLH}-t_{PHL} $	$R_L=350\Omega$ $C_L=15pF$	—	8	—	ns
Output Rise Time (10 to 90%)	t_r		—	22	—	ns
Output Fall Time (90 to 10%)	t_f		—	6.9	—	ns
Propagation Delay Time of	t_{ELH}	$R_L=350\Omega$	—	28	—	ns

Enable from V_{EH} to V_{EL}		$C_L=15\text{pF}$				
Propagation Delay Time of Enable from V_{EL} to V_{EH}	t_{EHL}	$V_{EL}=0\text{V}$ $V_{EH}=3\text{V}$	—	12	—	ns

Recommended temperature range ($T_A = -40^\circ\text{C} \sim +85^\circ\text{C}$, $4.5\text{V} \leq V_{CC} \leq 5.5\text{V}$), $I_F = 7.5\text{mA}$ Unless otherwise stated.

Typical values $T_A = 25^\circ\text{C}$, $V_{CC} = 5.0\text{V}$.

Parameter	Symbol	Condition	Min	Typ	Max	Unit
Logic High Common Mode Transient Immunity	$ CM_H $	$V_{CC}=3.3\text{V}$, $V_{CM}=1000\text{V}$, $R_L=350\Omega$ $I_F=0\text{mA}$, $T_A=25^\circ\text{C}$	10	15	—	kV/ μs
		$V_{CC}=5\text{V}$, $V_{CM}=1000\text{V}$, $R_L=350\Omega$ $I_F=0\text{mA}$, $T_A=25^\circ\text{C}$	10	15	—	
Logic Low Common Mode Transient Immunity	$ CM_L $	$V_{CC}=3.3\text{V}$, $V_{CM}=1000\text{V}$, $R_L=350\Omega$ $I_F=10\text{mA}$, $T_A=25^\circ\text{C}$	10	15	—	kV/ μs
		$V_{CC}=5\text{V}$, $V_{CM}=1000\text{V}$, $R_L=350\Omega$ $I_F=10\text{mA}$, $T_A=25^\circ\text{C}$	10	15	—	

Parameter	Symbol	Condition	Min	Typ	Max	Unit
Input-Output Insulation Leakage Current	I_{I-O}	45% RH, $t=5\text{s}$, $V_{I-O} = 3\text{kV DC}$, $T_A = 25^\circ\text{C}$	—	—	1	μA
Withstand Insulation Test Voltage	V_{ISO}	RH $\leq 50\%$, $t = 1\text{min}$, $T_A = 25^\circ\text{C}$	5000	—	—	V_{RMS}
Input-Output Resistance	R_{I-O}	$V_{I-O} = 500\text{V DC}$	—	10^{12}	—	Ω
Input-Output Capacitance	C_{I-O}	$f = 1\text{MHz}$, $T_A = 25^\circ\text{C}$	—	1	—	p

Recommended temperature range ($T_A = 40^\circ\text{C} \sim 85^\circ\text{C}$) Unless otherwise stated. Typical values $T_A = 25^\circ\text{C}$.

9、 Naming Rule

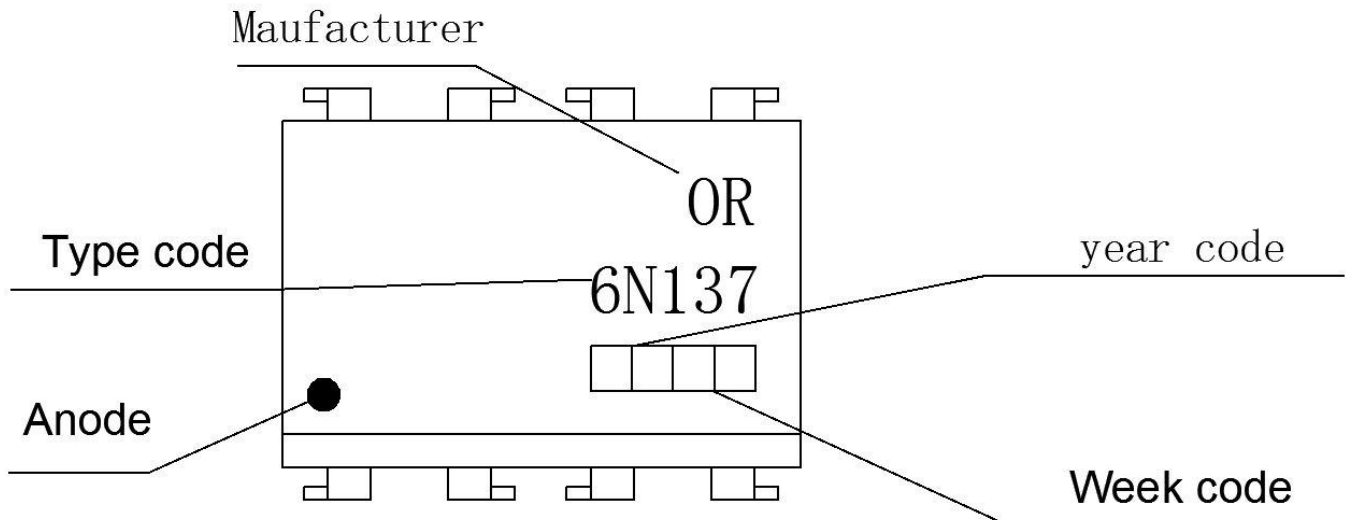

NOTE :

(1) year Code : '08' means' 2008 ', '09' means' 2009 'and so on.

(2) Week Code : 01 represents the first week, 02 represents the second week, and so on.

(3)OR :Manufacturer name, representing manufacturer Shenzhen Orient Components Co., Ltd.

(4) Type code: representing type 6N137.

(5)Anode

10、 Outer Dimension

(1) OR-6N137

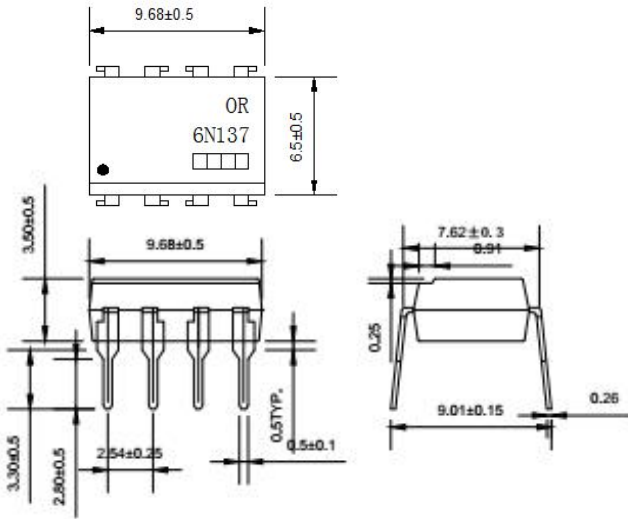

(2) OR-6N137M

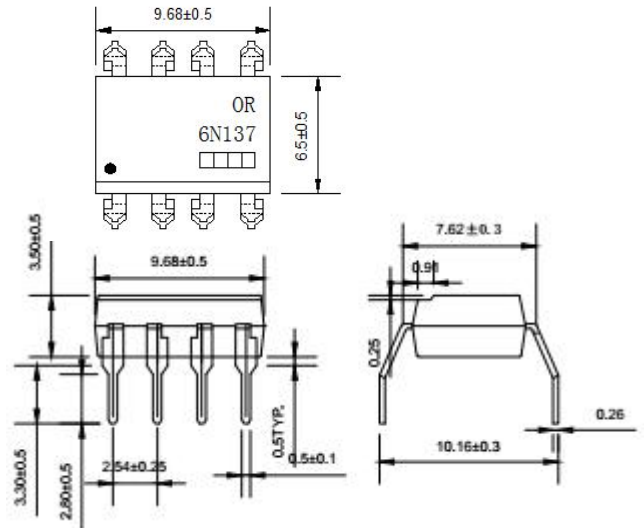

(3) OR-6N137S

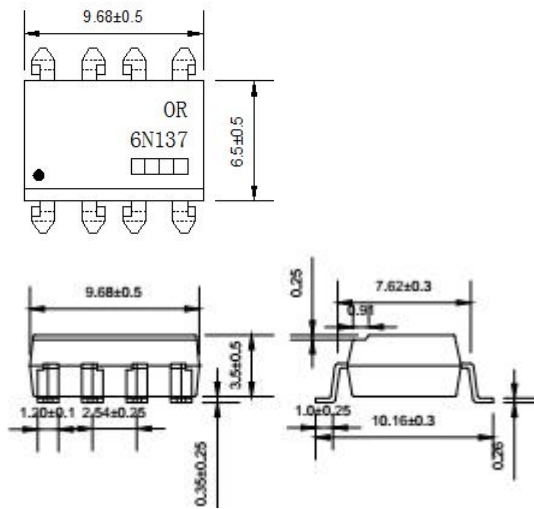

11、 Recommended Foot Print Patterns (Mount Pad)

(unit : mm)

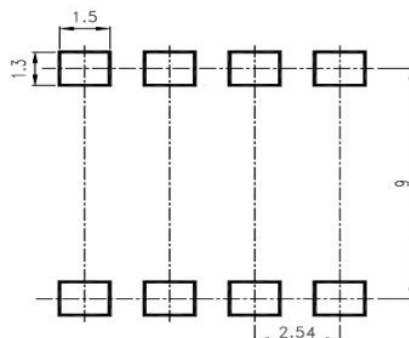

12、Taping Dimensions

(1) OR-6N137-TA

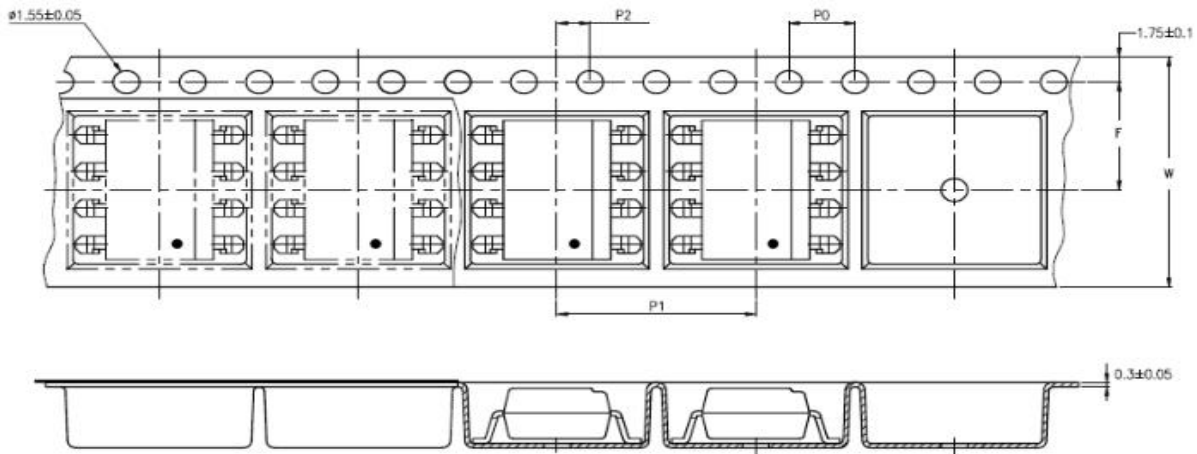

(2) OR-6N137-TA1

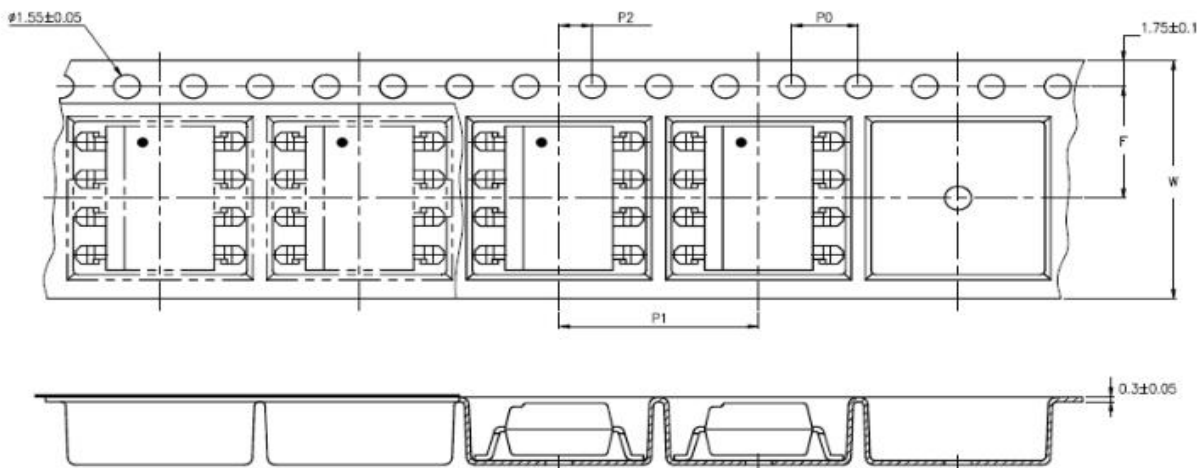

type	symbol	Size: mm (inches)
bandwidth	W	16±0.3 (0.63)
pitch	P0	4±0.1 (0.15)
pitch	F	7.5±0.1 (0.295)
	P2	2±0.1 (0.079)
interval	P1	12±0.1 (0.472)

Encapsulation type	TA/TA1
amount (pcs)	1000

13、 Temperature Profile Of Soldering

(1) IR Reflow soldering (JEDEC-STD-020C compliant)

Note: one solder backflow is recommended under the conditions described below in the temperature and time profile. Do not weld more than three times.

Configuration items	conditions
Preheat	
- T _{Smin}	150°C
- T _{Smax}	200°C
- Time (min to Max (TS)	90±30 sec
Soldering zone	
- temperature (T _L)	217°C
- time (t _L)	60 ~ 100 sec
Peak Temperature	260°C
Ramp-up rate	3°C / sec max.
Drop rate (3°C / sec max.)	3 ~ 6°C / sec

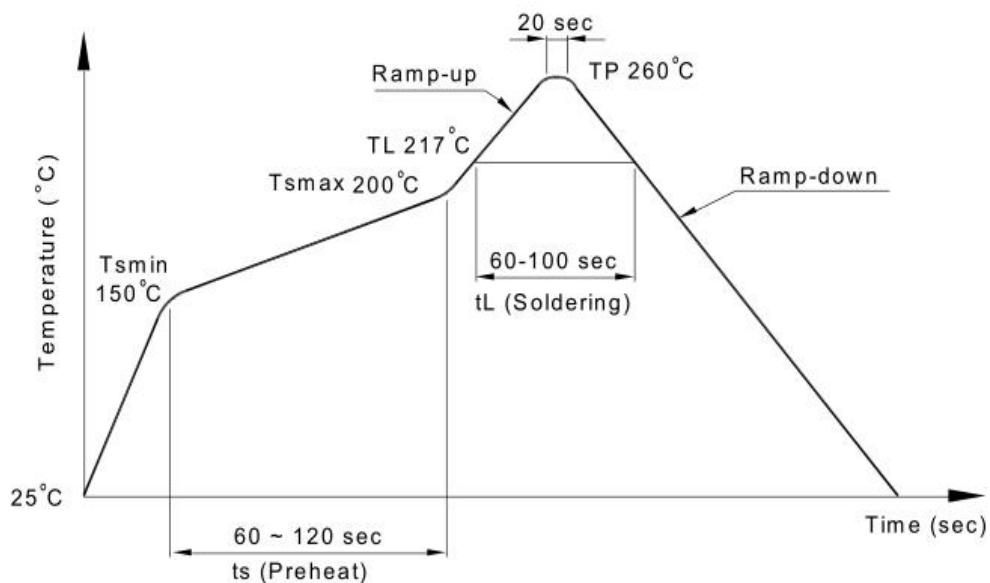

(2) Wave soldering (JEDEC22A111 compliant)

One-time welding is recommended under the temperature condition.

Temperature	260+0/-5°C
Time	10 sec
Preheat temperature	5 to 140°C
Preheat time	30 to 80 sec

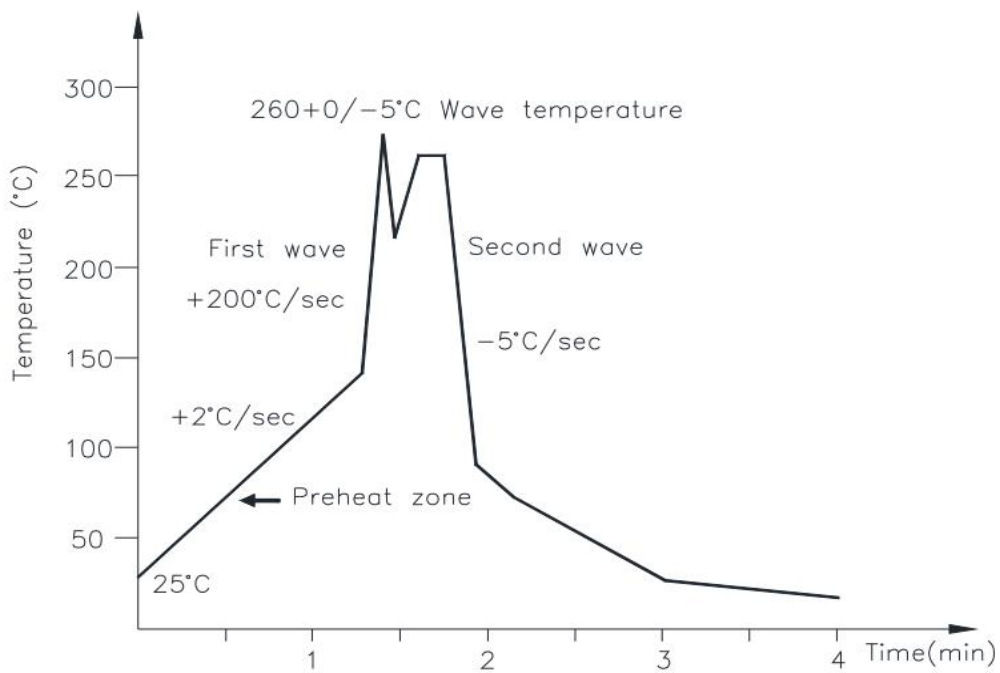

(3) Hand soldering by soldering iron

Single lead welding is allowed in each process and one-time welding is recommended.

Temperature	380+0/-5°C
Time	3 sec max

14、 Switching time test circuit

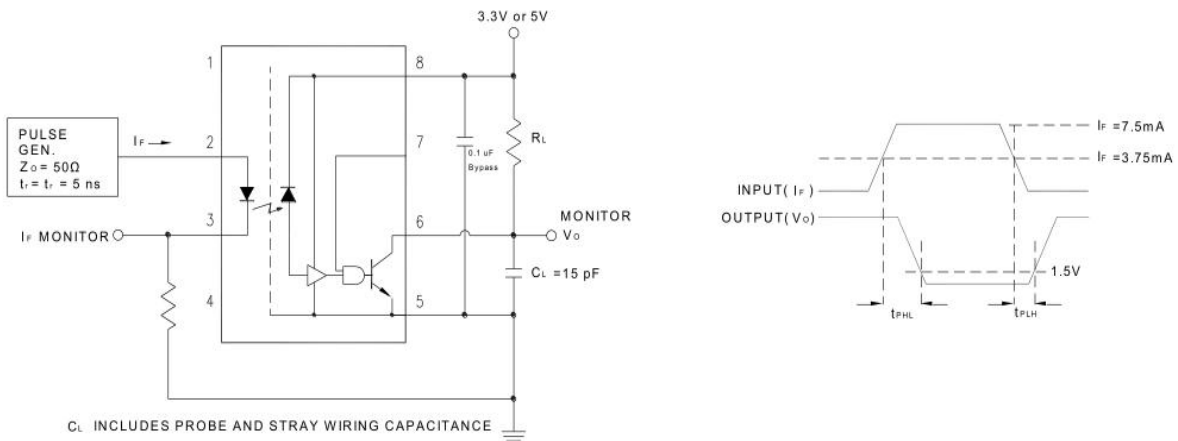

Figure 1: Test Circuit for t_{PHL} and t_{PLH}

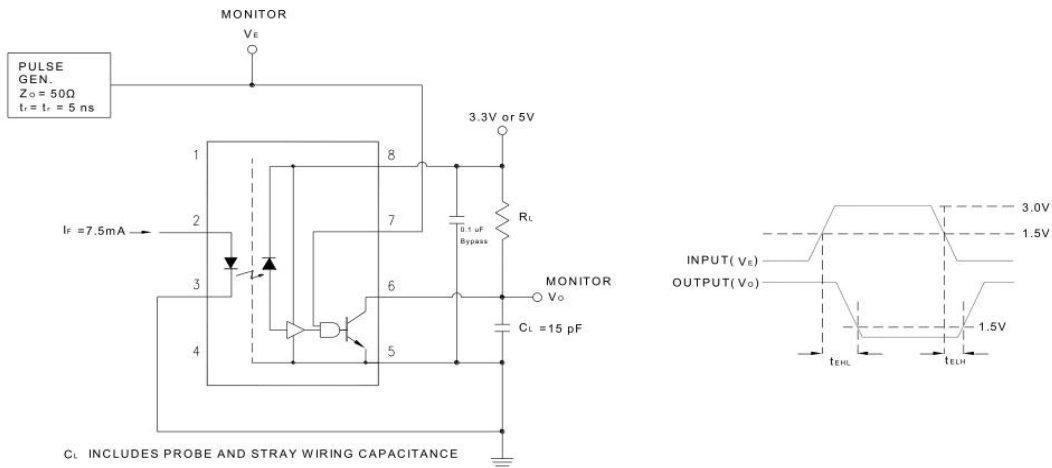

Figure 2: Single Channel Test Circuit for Common Mode Transient Immunity

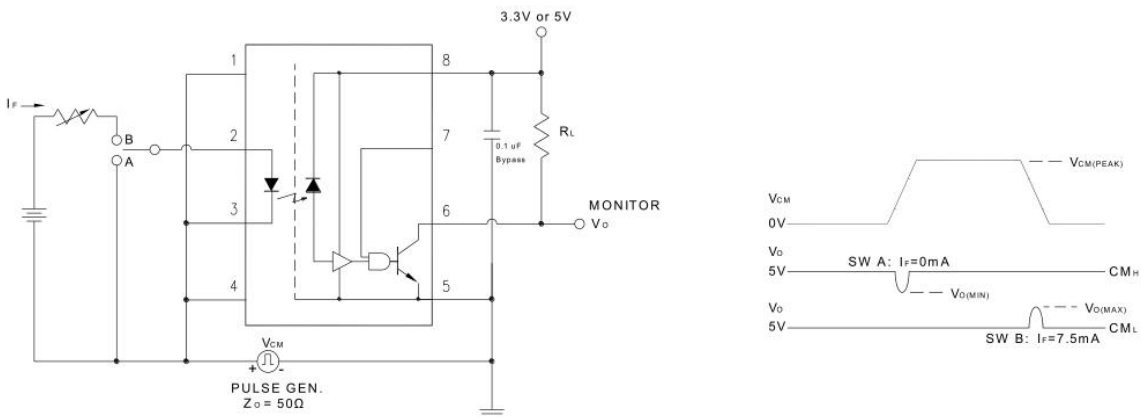

Figure 3: Single Channel Test Circuit for Common Mode Transient Immunity

15. Characteristics Curve

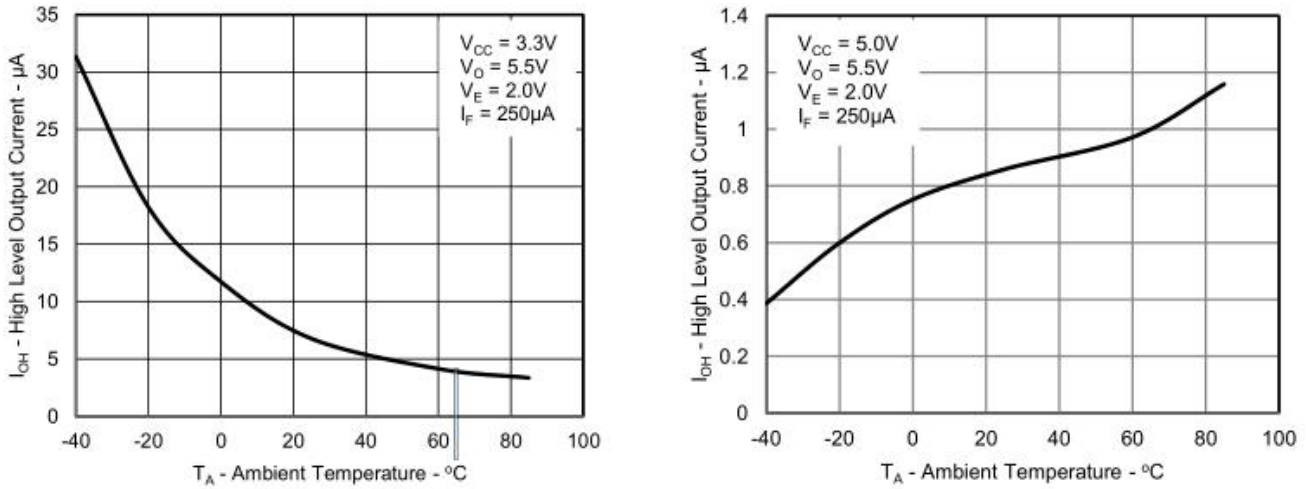

Figure 4: Typical High Level Output Current vs. Ambient Temperature

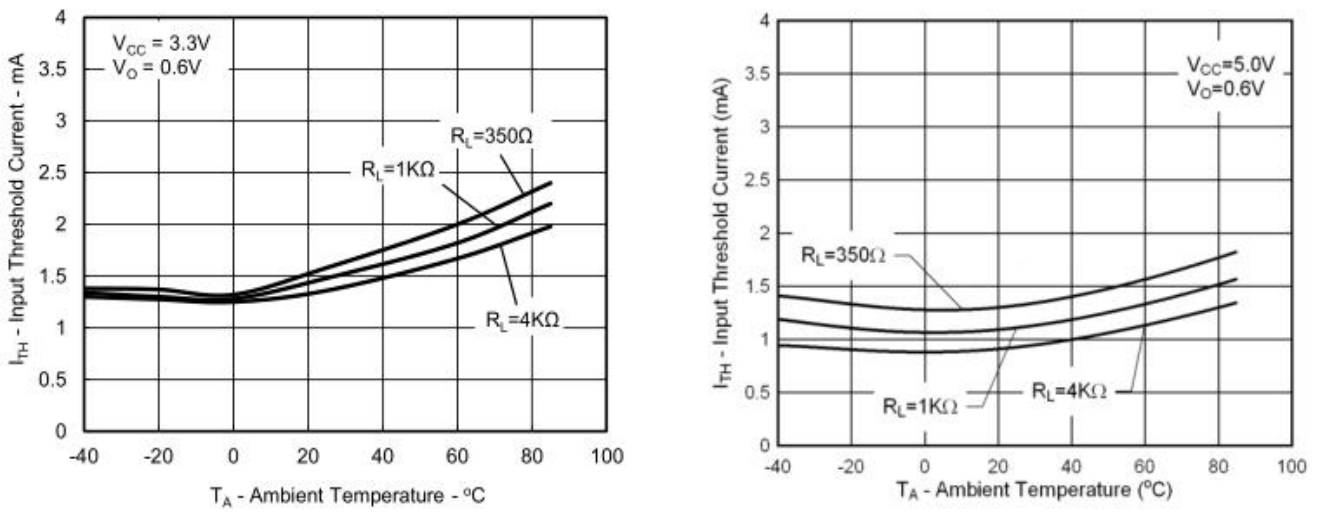

Figure 5: Typical Input Diode Threshold Current vs. Ambient Temperature

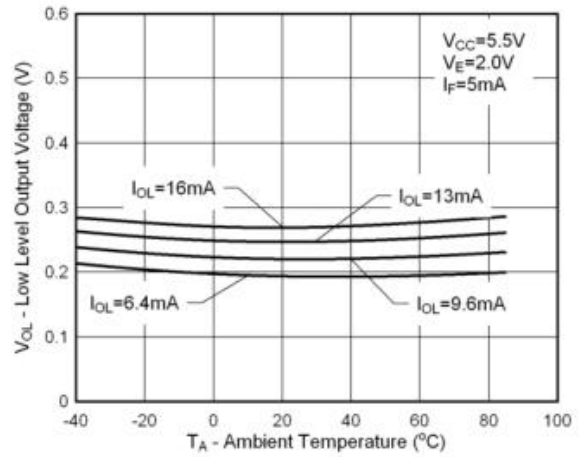
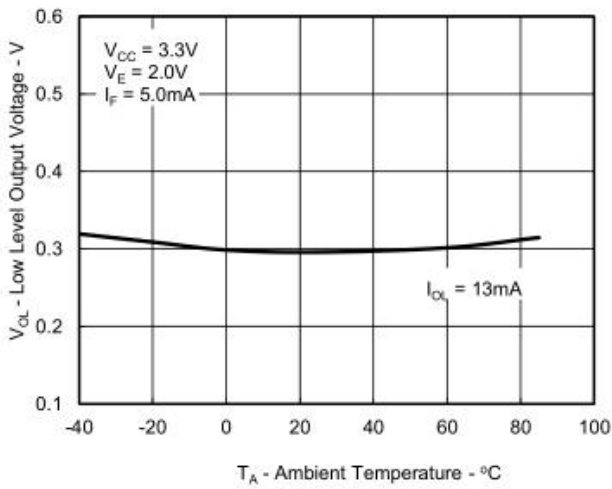

Figure 6: Typical Low Level Output Voltage vs. Ambient Temperature

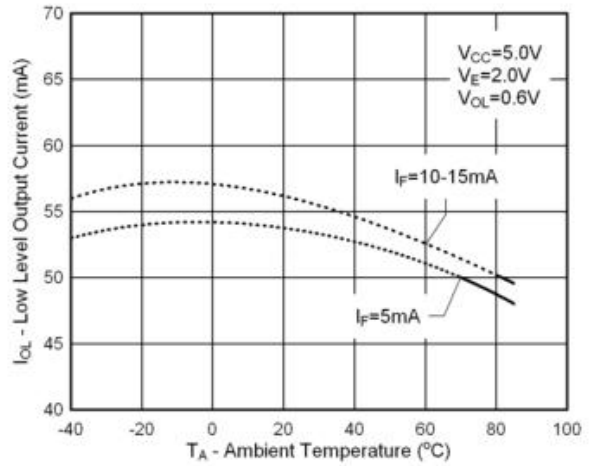
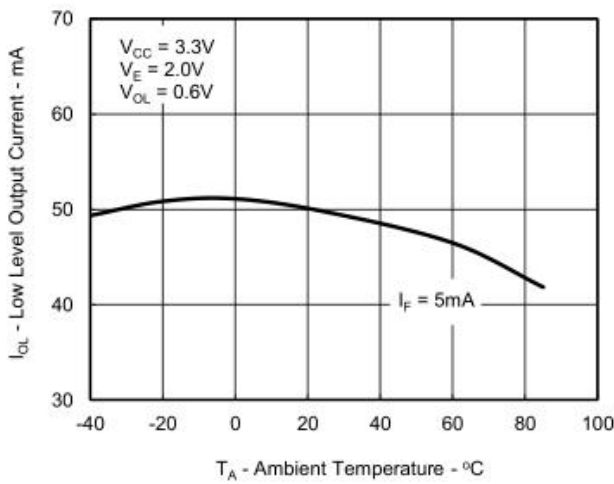

Figure 7: Typical Low Level Output Current vs. temperature

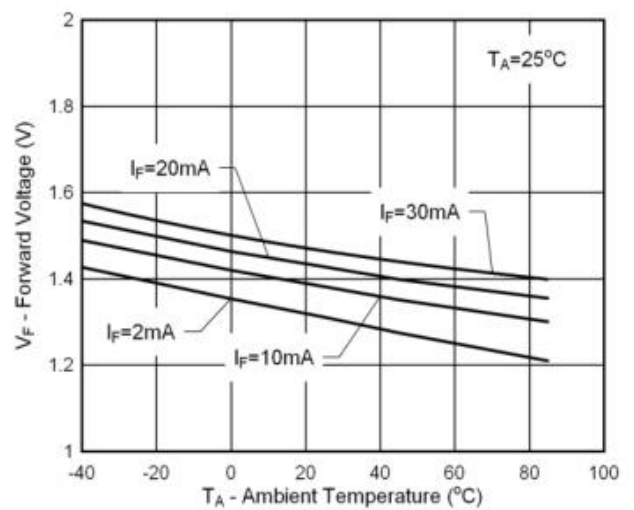
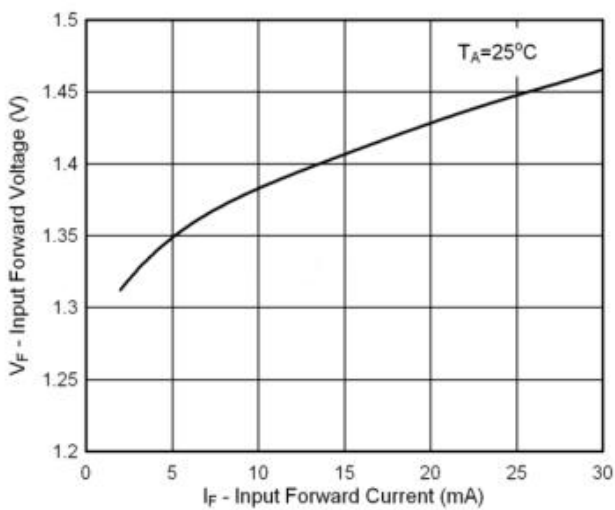

Figure 8: Typical Input Diode Forward Characteristic

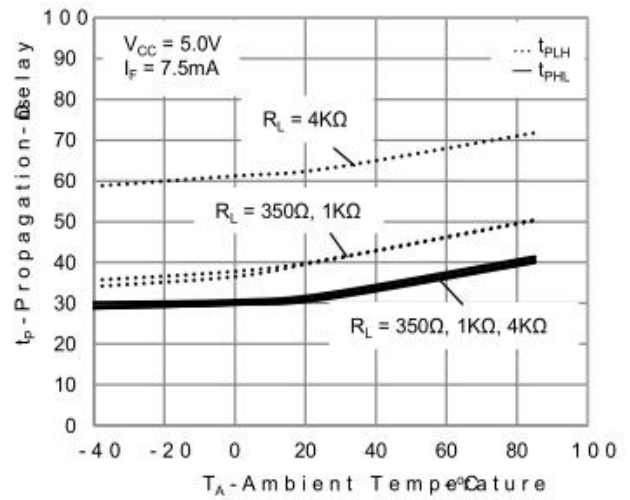
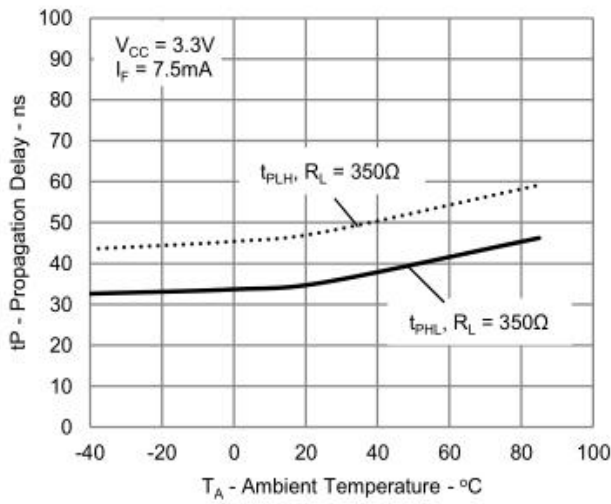

Figure 9: Typical Propagation Delay vs. Ambient Temperature

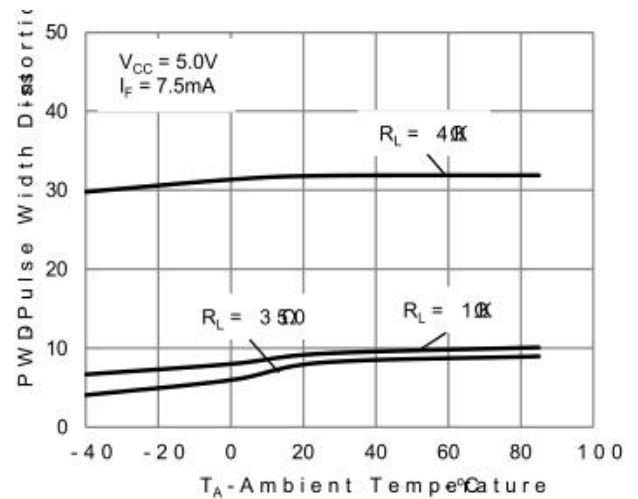
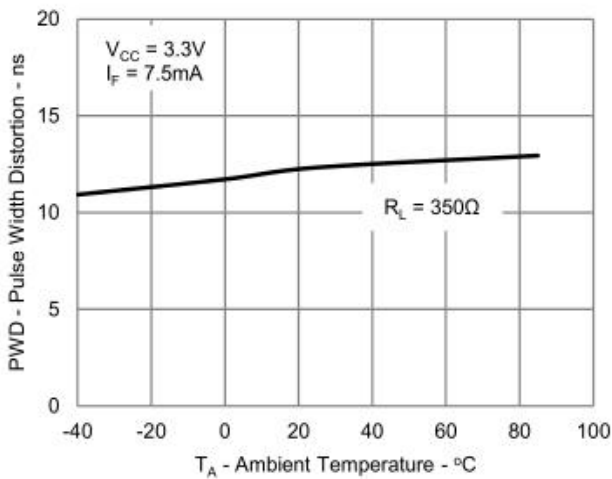

Figure 10: Typical Pulse Width Distortion vs. Ambient Temperature

X-ON Electronics

Largest Supplier of Electrical and Electronic Components

Click to view similar products for [High Speed Optocouplers](#) category:

Click to view products by [Orient](#) manufacturer:

Other Similar products are found below :

[6N136F](#) [PS8502L2-AX](#) [ACNW261L-000E](#) [ACPL-344JT-000E](#) [ACPL-K49T-500E](#) [ACPL-K74T-000E](#) [ACPL-K75T-000E](#) [ACPL-W21L-560E](#) [ACPL-K44T-500E](#) [TLP187\(TPL,E\(T](#) [TLP2601\(TP1,F\)](#) [610737H](#) [6N137A-X001](#) [6N137A-X017T](#) [6N139-X007T](#) [HCPL2630M](#) [HCPL2731SM](#) [TLP555\(F\)](#) [HCPL2630SM](#) [PS2841-4A-F3-AX](#) [PS9817A-1-F3-AX](#) [PS9821-2-F3-AX](#) [ORPC-817D](#) [ORPC-817M/C](#) [ORPC-817M/B](#) [PT17-51C/L129\(BIN2\)](#) [TLP521-4GBSM](#) [UMW817C](#) [6N137S1\(TA\)](#) [TLP521GB](#) [TLP521GB-S](#) [PS2501](#) [PS2501-S](#) [TLP785GB](#) [TLP785GB-S](#) [LTV-214-G](#) [TLP2766A\(E](#) [TLP2766A\(LF4,E](#) [LCR-0202](#) [EL814S1\(TA\)-V](#) [PC817X4NSZ2B](#) [CYPC817](#) [OR-MOC3023](#) [TLP267J\(TPL,E\(T](#) [TLP109\(TPL,E\(O](#) [EL2514S1\(TU\)\(CLW\)-G](#) [EL816S2\(C\)\(TU\)-F](#) [TLP281-4](#) [MOC3023M](#) [ACPL-K49T-060E](#)