



# Specification Sheet

P/N: Photocoupler

Customer:

Mfg P/N: OR-3H7

Date:

**SHENZHEN ORIENT TECHNOLOGY CO.,LTD.**

Block A 3rd Floor No.4 Building, Tian'an Cyber Park, Huangge Rd, LongGang Dist, Shenzhen, GD

TEL: 0755-29681816

FAX: 0755-29681200

[www.orient-opto.com](http://www.orient-opto.com)

### 1、特点 (Features)

1. 电流转换比 (CTR : MIN. 50% at  $I_F = 5\text{mA}$ ,  $V_{CE} = 5\text{V}$ ,  $T_a = 25^\circ\text{C}$ )
2. 绝缘电压: ( $V_{ISO} = 3,750\text{Vrms}$ )
3. 高集电极发射极电压 ( $V_{CEO} = 80\text{V}$ )
4. 温度范围:  $-55^\circ\text{C}$  to  $110^\circ\text{C}$
5. 无铅, 符合 RoHS 标准



### 2、说明 (Instructions)

描述该 ORPC-3H7 系列器件包含一个红外发光二极管, 光电晶体管探测器。它们封装在一个 4 引脚 SOP 里面, 不含卤素和  $\text{Sb}_2\text{O}_3$ 。

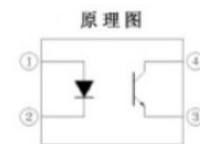

引脚配置  
1. 阳极  
2. 阴极  
3. 发射极  
4. 集电极

### 3、应用范围 (Application Range)

- (1). 需要高密度安装的混合 PCB 基板
- (2). 可编程控制器
- (3). 系统器具、测量仪器

### 4、最大绝对额定值 (常温 $T = 25^\circ\text{C}$ ) Max Absolute rated Value (Normal Temperature = $25^\circ\text{C}$ )

参数 Parameter		符号 Symbol	额定值 Rated Value	单位 Unit
输入 Input	正向电流 (Forward Current)	$I_F$	50	mA
	峰值正向电流 (Peak forward current)( $t=10\mu\text{s}$ )	$I_{FM}$	1	A
	反向电压 (Reverse Voltage)	$V_R$	6	V
	功率耗损 (Power Dissipation)	P	70	mW
输出 Output	集极与射极电压 (Collector and emitter Voltage)	$V_{CEO}$	80	V
	射极与集极电压 (Emitter and collector Voltage)	$V_{ECO}$	7	
	集极电流 (Collector Current)	$I_C$	50	mA
	功率耗损 (Power Dissipation)	$P_C$	150	mW
总功率消耗 (Total Power Dissipation)		$P_{tot}$	200	mW
*1 绝缘电压 (Insulation Voltage)		$V_{iso}$	3750	Vrms
额定脉冲绝缘电压 (Rated Impulse Insulation Voltage)		$V_{IORM}$	630	V
工作温度 (Working Temperature)		$T_{opr}$	-30 to + 110	°C
存贮温度 (Deposit Temperature)		$T_{stg}$	-55 to + 125	
*2 焊锡温度 (Soldering Temperature)		$T_{sol}$	260	

\*1 .工作 AC 为 1 分钟, R.H. = 40 ~ 60%      1. AC For 1 Minute, R.H. = 40 ~ 60%

隔离电压采用以下方法测量。      Isolation voltage shall be measured using the following method.

- (1)主侧阳极与阴极之间、收集器与发射器之间的短二次侧。(1) Short between anode and cathode on the primary side and between collector and emitter on thesecondary side
- (2)零交叉电路应使用隔离电压测试仪。(2) The isolation voltage tester with zero-cross circuit shall be used.
- (3)应用电压波形为正弦波。(3) The waveform of applied voltage shall be a sine wave.

\*2. 锡焊时间为 10 秒 soldering time is 10 seconds

5、光电特性(常温 T=25℃) (Opto-electronic Characteristics)

参数 Parameter		符号 Symbol	条件 Condition	最小 Min	典型值 Typ.*	最大 Max	单位 Unit
输入 (Input)	正向电压 (Forward Current)	$V_F$	$I_F=10mA$	1.0	---	1.3	V
	反向电压 (Reverse Voltage)	$I_R$	$V_R=5V$	---	---	10	$\mu A$
	结电容 (Terminal Capacitance)	$C_t$	$V=0, f=1KHz$	---	30	250	pF
输出 (Output)	集极至射极电流 (Collector Dark Current)	$I_{CEO}$	$V_{CE}=20V,$ $I_F=0mA$	---	---	100	nA
	集极与射极衰减电压 (Collector-Emitter Breakdown Voltage)	$BV_{CEO}$	$I_C=0.1mA$ $I_F=0mA$	80	---	---	V
	射极与集极衰减电压 (Emitter-Collector Breakdown Voltage)	$BV_{ECO}$	$I_E=10\mu A$ $I_F=0mA$	7	---	---	V
传输特性 (Transforming Characteristics)	*1 电流转换比 (Current Transfer Ratio)	CTR	$I_F=5mA$	100	---	600	%
	集极电流 (Collector Current)	$I_C$	$V_{CE}=5V$	5	---	30	mA
	集极与射极饱和电压 (Collector-Emitter Saturation Voltage)	$V_{CE(sat)}$	$I_F=8mA$ $I_C=2.4mA$	---	---	0.4	V
	绝缘阻抗 (Insulation Impedance)	$R_{iso}$	DC500V 40~60%R.H.	$5 \times 10^{10}$	$1 \times 10^{11}$	---	$\Omega$
	浮动电容 (Floating Capacitance)	$C_f$	$V=0, f=1MHz$	---	0.6	1	pF
	上升时间 (Response Time)	$t_r$	$V_{CE}=5V, I_C=2mA$	---	2	12	$\mu s$
	下降时间 (Descend Time)	$t_f$	$R_L=100\Omega$ $f=100Hz$	---	3	12	$\mu s$

- 电流转换比 Current Conversion Ratio =  $I_C / I_F \times 100\%$

6、电流转换比的等级分类 (Rank table of current transfer ratio CTR)

MODEL NO.	CTR Rank	Min.	Max.	Unit	测试条件 (Condition)
ORPC-3H7	A	100	160	%	IF=5mA, V <sub>CE</sub> =5V, Ta=25°C
	B	130	260		
	C	200	400		
	D	300	600		
	No mark	50	600		

7、命名规则 (Naming Rule)

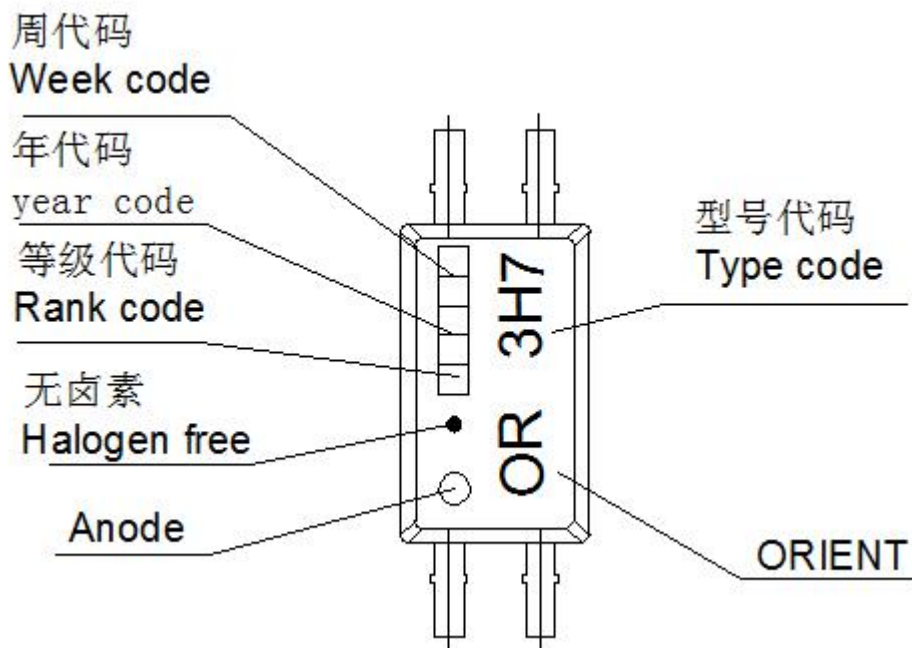

注:

- (1). “●” 表示无卤素标志。
- (2). 等级代码 CTR 档位
- (3). 第一位年份代码, 例如: 2018=18, 如此类推。  
第二位周数代码从“01”到“53”
- (4). 型号代码 “3H7”
- (5). OR 制造商名称 ORIENT

8、外形尺寸 (Outer Dimension)

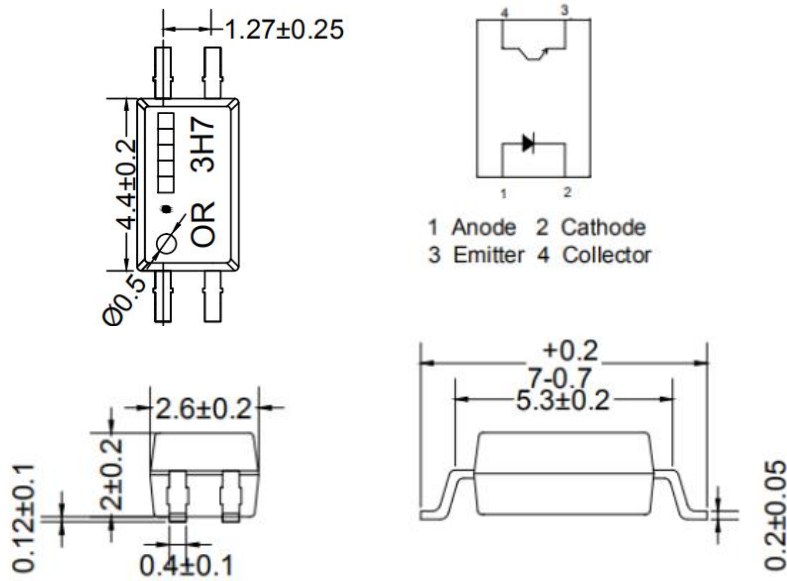

9、推荐的焊盘尺寸 (Recommended Foot Print Patterns (Mount Pad))

九、单位: mm

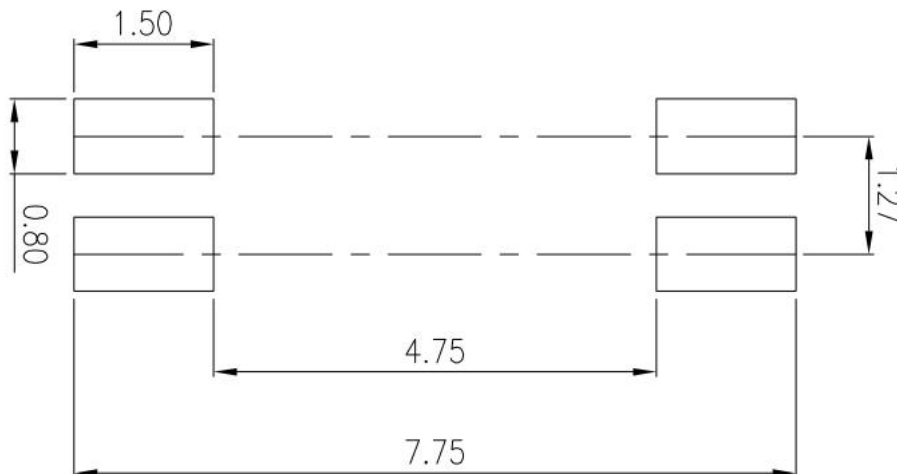

10、编带尺寸 (Taping Dimensions)

(1) .OR-3H7-TP

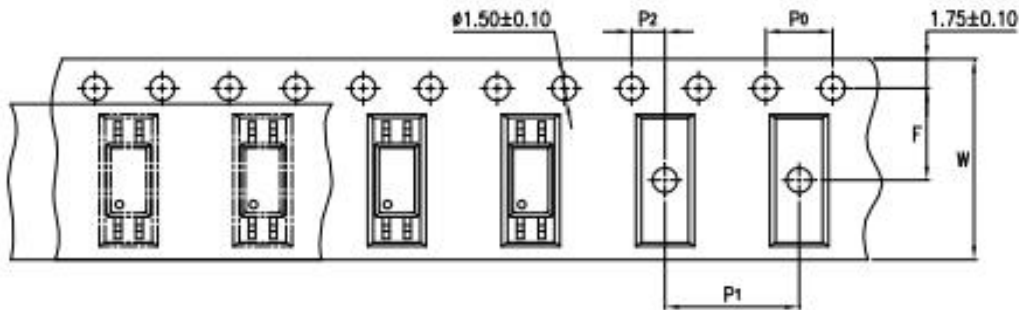

(2) .OR-3H7-TP1

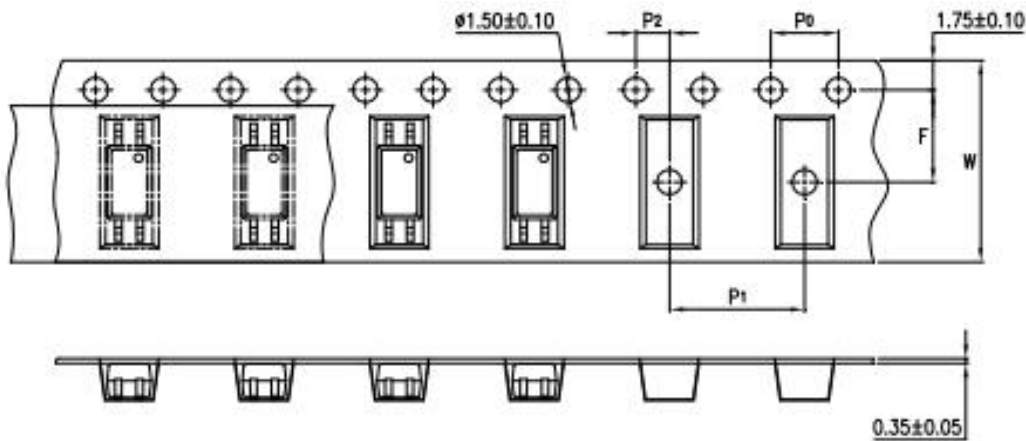

类型	符号	尺寸:毫米(英寸)
带宽	W	12±0.3 (0.47)
孔距	P0	4±0.1 (0.15)
孔距	F	5.5±0.1 (0.217)
	P2	2±0.1 (0.079)
间隔	P1	8±0.1 (0.315)

封装类型	ORPC-3H7
数量 (个)	3000

11、焊接温度曲线 (Temperature Profile Of Soldering)

(1) . 红外回流焊 (jedec-std-020c 兼容) (IR Reflow soldering (JEDEC-STD-020C compliant))

注意：一次焊接回流建议在温度和时间配置文件如下所示的条件下。不要焊接超过三次。

配置项	条件
预热 (Preheat)	
-最低温度 (T <sub>Smin</sub> )	150°C
-最高温度 (T <sub>Smax</sub> )	200°C
-时间 (最小到最大 (T <sub>S</sub> ))	90±30 sec
焊接区 (Soldering zone)	
-温度 (T <sub>L</sub> )	217°C
-时间 (t <sub>L</sub> )	60~100 sec
峰值温度 (Peak Temperature)	260°C
爬升率 (Ramp-up rate)	3°C / sec max.
斜坡下降率 (3°C / sec max.)	3~6°C / sec

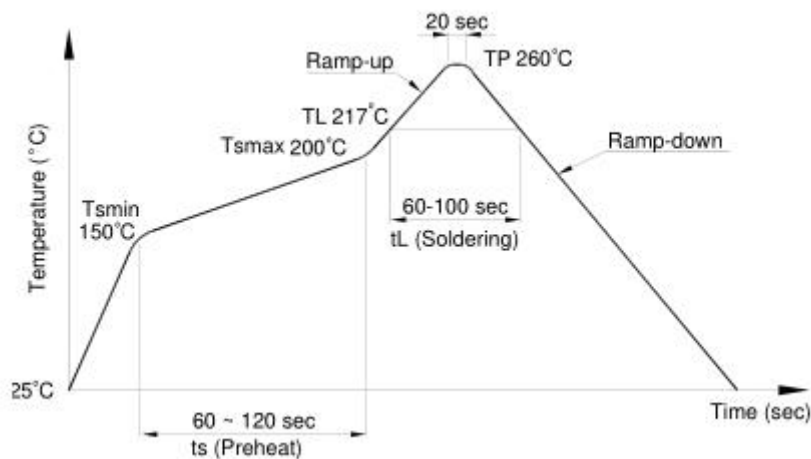

(2). 波峰焊接 (jedec22a111 兼容) (Wave soldering (JEDEC22A111 compliant))

建议在温度条件下一一次性焊接。

温度 (Temperature)	260+0/-5°C
时间 (Time)	10 sec
预热温度 (Preheat temperature)	25 to 140°C
预热时间 (Preheat time)	30 to 80 sec

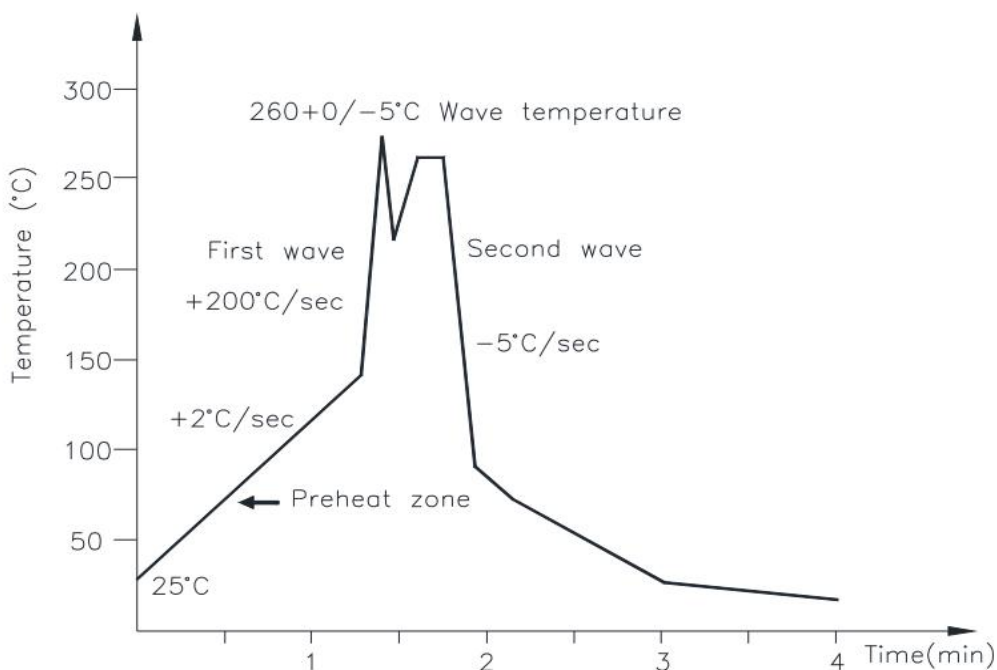

(3). 电烙铁手工焊接 (Hand soldering by soldering iron)

允许单铅焊接在每一个过程中, 建议一次性焊接。

温度 (Temperature)	380+0/-5°C
时间 (Time)	3 sec max



12、特性曲线 (Characteristics Curve)

Figure 1. Collector Power Dissipation vs. Ambient Temperature

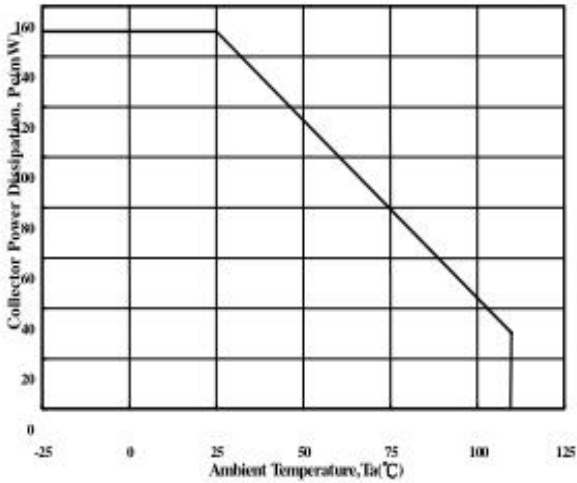

Figure 2. Forward Current vs. Ambient Temperature

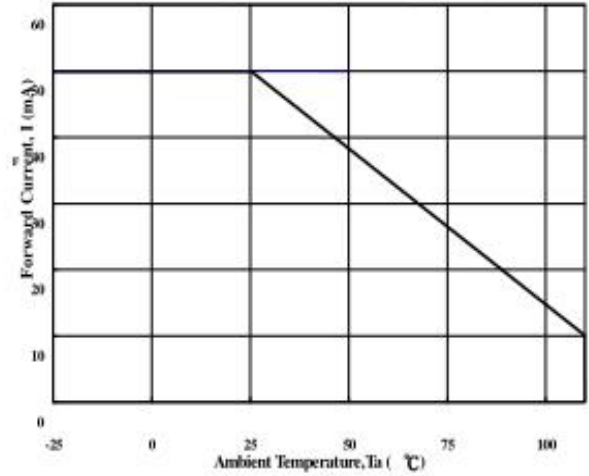

Figure 3. Forward Current vs. Forward Voltage

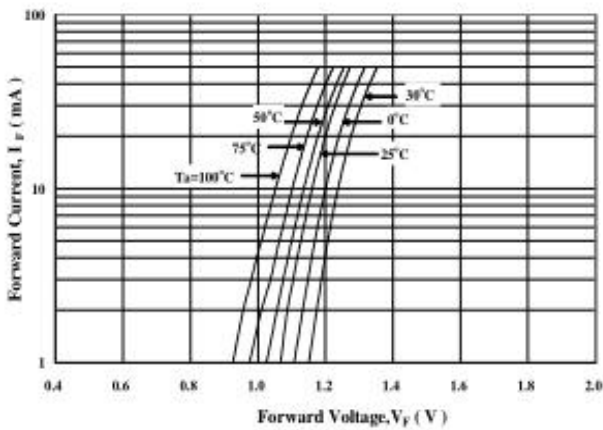

Figure 4. Forward Voltage Temperature Coefficient vs. Forward Current

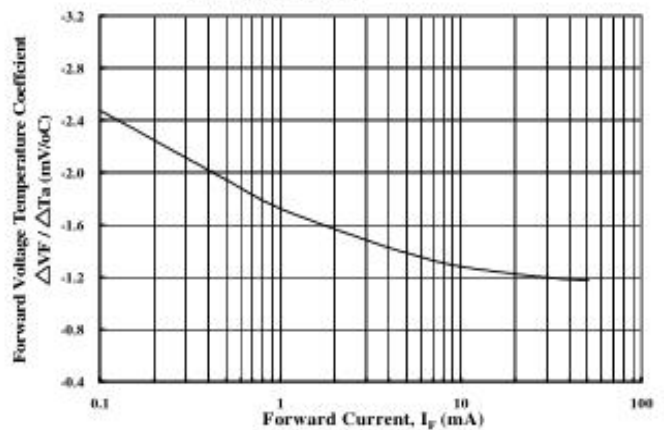

Figure 5. Pulse Forward Current vs. Duty Cycle Ratio



Figure 6. Pulse Forward Current vs. Pulse Forward

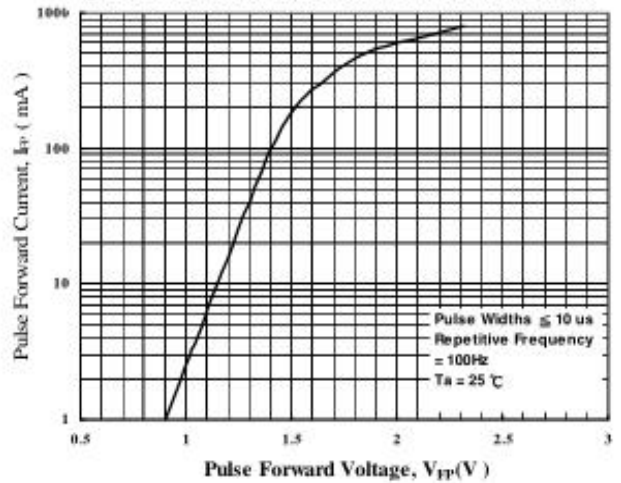

Figure 7. Collector-Emitter Saturation Voltage vs. Forward

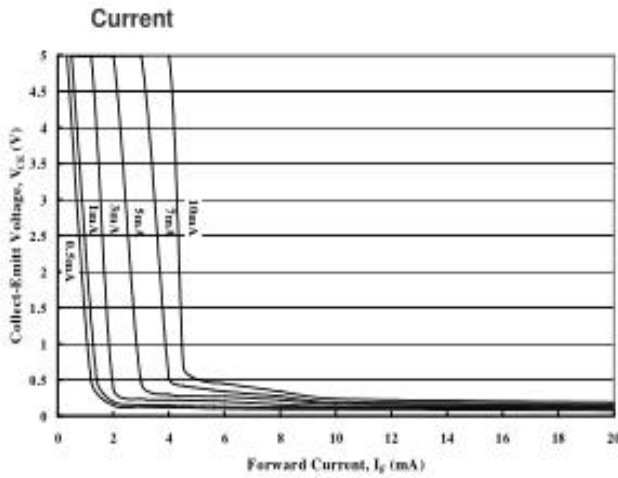

Figure 8. Collector Current vs. Collector-Emitter

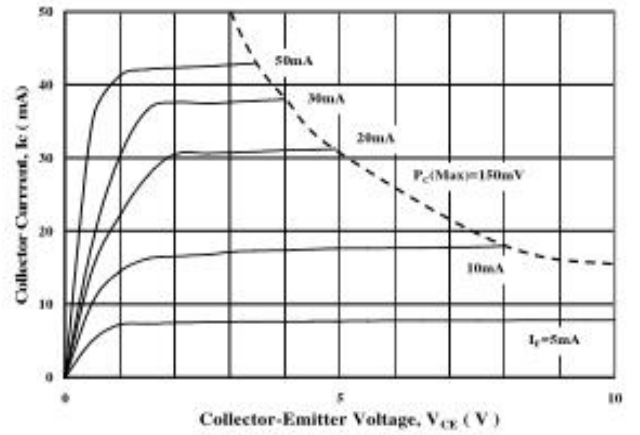

Figure 9. Collector Current vs. Small Collector-Emitter

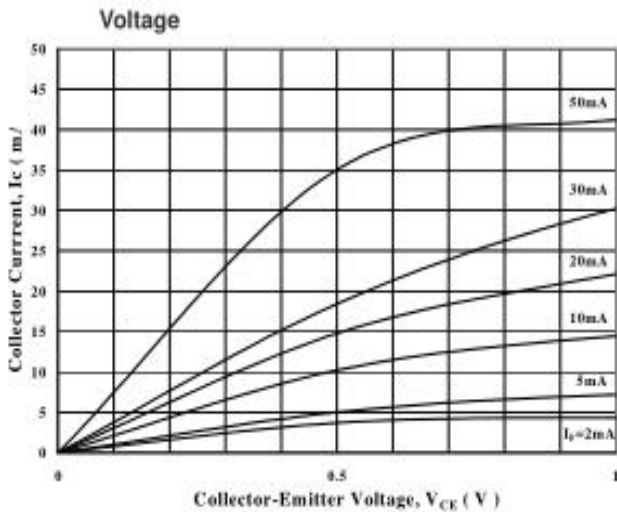

Figure 10. Normalized CTR vs. Forward Current

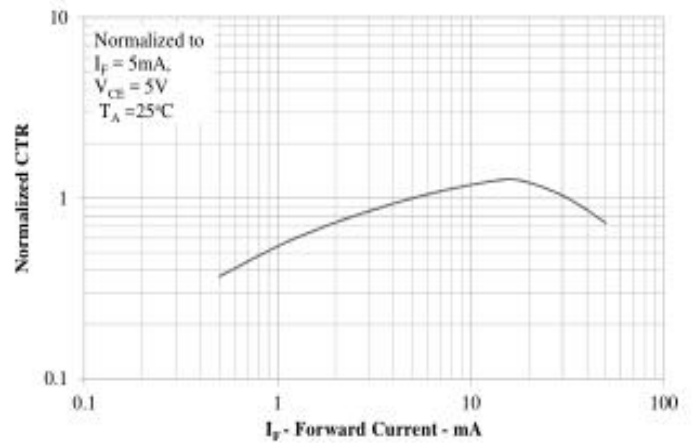

Figure 11. Collector Dark Current vs. Ambient Temperature

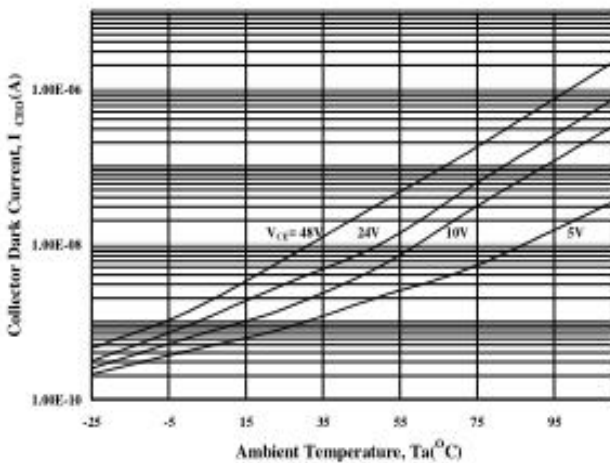

Figure 12. Current Transfer Ratio vs. Forward Current

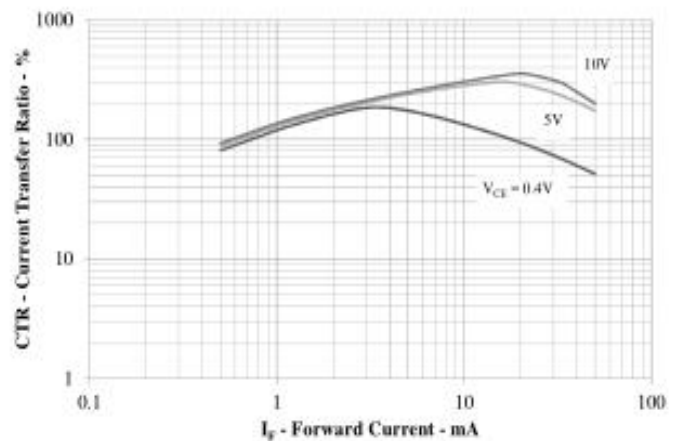

Figure 13. Normalized CTR vs. Ambient Temperature

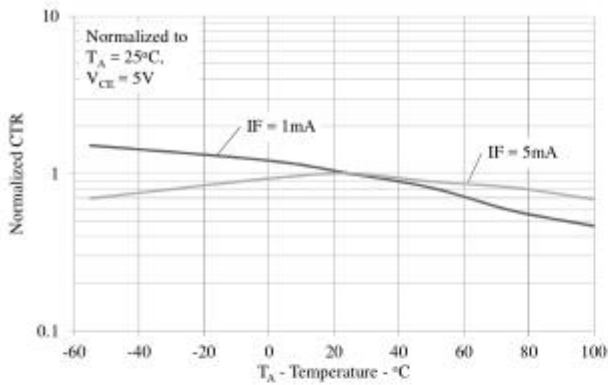

Figure 14. Collector-Emitter Saturation Voltage vs. Ambient Temperature

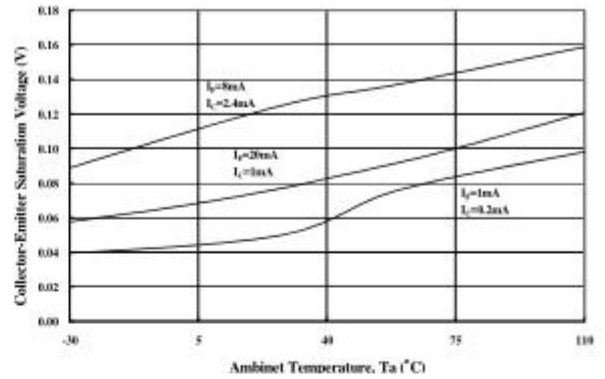

Figure 15. Collector Current vs. Ambient Temperature

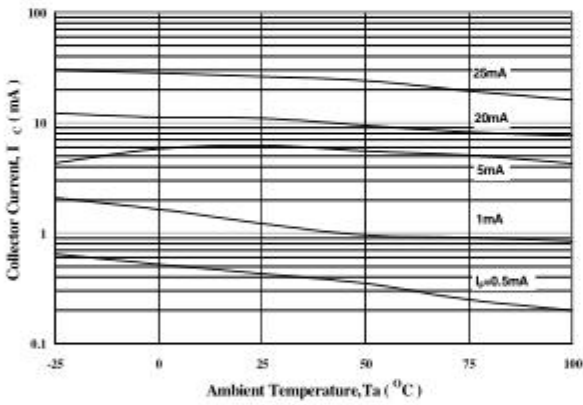

Figure 16. Switching Time vs. Load Resistance

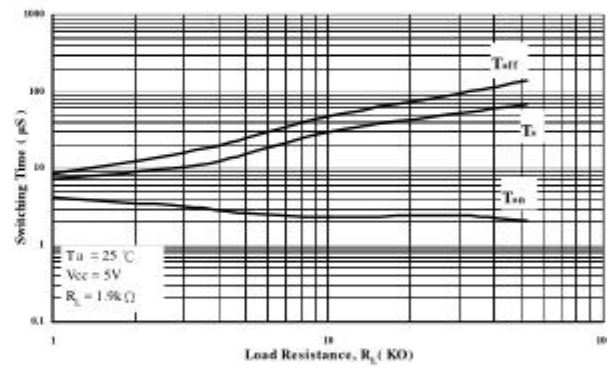

Figure 17. Switching Time vs. Ambient Temperature

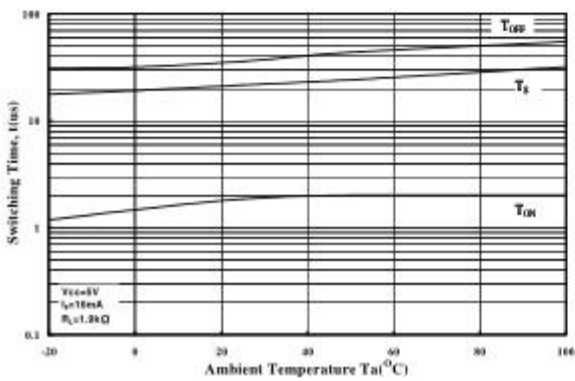
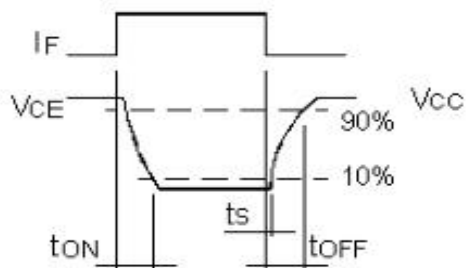
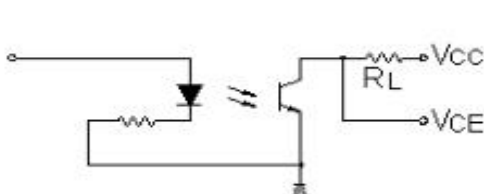
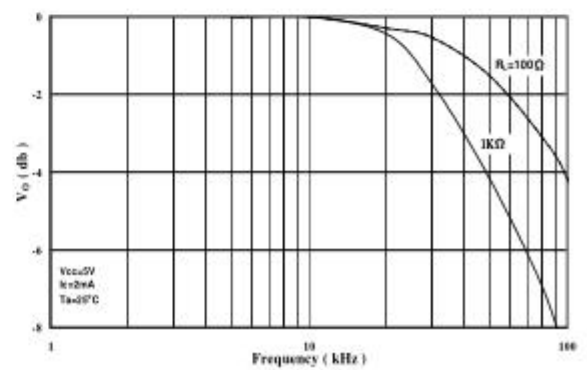

Figure 18. Frequency Response



## X-ON Electronics

Largest Supplier of Electrical and Electronic Components

*Click to view similar products for [High Speed Optocouplers](#) category:*

*Click to view products by [Orient](#) manufacturer:*

Other Similar products are found below :

[6N136F](#) [PS8502L2-AX](#) [ACNW261L-000E](#) [ACPL-344JT-000E](#) [ACPL-K49T-500E](#) [ACPL-K74T-000E](#) [ACPL-K75T-000E](#) [ACPL-W21L-560E](#) [ACPL-K44T-500E](#) [TLP187\(TPL,E\(T](#) [TLP2601\(TP1,F\)](#) [610737H](#) [6N137A-X001](#) [6N137A-X017T](#) [6N139-X007T](#) [HCPL2630M](#) [HCPL2731SM](#) [TLP555\(F\)](#) [HCPL2630SM](#) [PS2841-4A-F3-AX](#) [PS9817A-1-F3-AX](#) [PS9821-2-F3-AX](#) [ORPC-817D](#) [ORPC-817M/C](#) [ORPC-817M/B](#) [PT17-51C/L129\(BIN2\)](#) [TLP521-4GBSM](#) [UMW817C](#) [6N137S1\(TA\)](#) [TLP521GB](#) [TLP521GB-S](#) [PS2501](#) [PS2501-S](#) [TLP785GB](#) [TLP785GB-S](#) [LTV-214-G](#) [TLP2766A\(E](#) [TLP2766A\(LF4,E](#) [LCR-0202](#) [EL814S1\(TA\)-V](#) [PC817X4NSZ2B](#) [CYPC817](#) [OR-MOC3023](#) [TLP267J\(TPL,E\(T](#) [TLP109\(TPL,E\(O](#) [EL2514S1\(TU\)\(CLW\)-G](#) [EL816S2\(C\)\(TU\)-F](#) [TLP281-4](#) [MOC3023M](#) [ACPL-K49T-060E](#)