

## N-channel Enhanced mode TO-220/TO-220F/TO-263 MOSFET

### Features

- High ruggedness
- Low  $R_{DS(ON)}$  (Typ 0.23Ω)@ $V_{GS}=10V$
- Low Gate Charge (Typ 43nC)
- Improved dv/dt Capability
- 100% Avalanche Tested
- Application: LED, Charge, PC Power

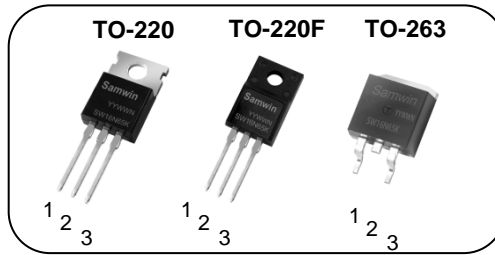

1. Gate 2. Drain 3. Source

$BV_{DSS}$  : 650V

$I_D$  : 16A

$R_{DS(ON)}$  : 0.23Ω

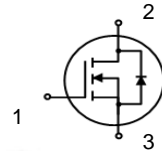

### General Description

This power MOSFET is produced with super junction advanced technology of SAMWIN. This technology enable the power MOSFET to have better characteristics, including fast switching time, low on resistance, low gate charge and especially excellent avalanche characteristics.

### Order Codes

Item	Sales Type	Marking	Package	Packaging
1	SW P 16N65K	SW16N65K	TO-220	TUBE
2	SW F 16N65K	SW16N65K	TO-220F	TUBE
3	SW B 16N65K	SW16N65K	TO-263	TUBE

### Absolute maximum ratings

Symbol	Parameter	Value			Unit
		TO-220	TO-220F	TO-263	
$V_{DSS}$	Drain to source voltage	650			V
$I_D$	Continuous drain current (@ $T_C=25^\circ C$ )	16*			A
	Continuous drain current (@ $T_C=100^\circ C$ )	10.1*			A
$I_{DM}$	Drain current pulsed (note 1)	64			A
$V_{GS}$	Gate to source voltage	$\pm 30$			V
$E_{AS}$	Single pulsed avalanche energy (note 2)	300			mJ
$E_{AR}$	Repetitive avalanche energy (note 1)	16			mJ
dv/dt	MOSFET dv/dt ruggedness (@ $V_{DS}=0\sim 400V$ )	30			V/ns
dv/dt	Peak diode recovery dv/dt (note 3)	20			V/ns
$P_D$	Total power dissipation (@ $T_C=25^\circ C$ )	271.7	32.2	192.3	W
	Derating factor above 25°C	2.2	0.26	1.5	W/°C
$T_{STG}, T_J$	Operating junction temperature & storage temperature	-55 ~ + 150			°C
$T_L$	Maximum lead temperature for soldering purpose, 1/8 from case for 5 seconds.	300			°C

\*. Drain current is limited by junction temperature.

### Thermal characteristics

Symbol	Parameter	Value			Unit
		TO-220	TO-220F	TO-263	
$R_{thjc}$	Thermal resistance, Junction to case	0.46	3.88	0.65	°C/W
$R_{thja}$	Thermal resistance, Junction to ambient	55.4	45.1		°C/W

Electrical characteristic (  $T_C = 25^\circ\text{C}$  unless otherwise specified )

Symbol	Parameter	Test conditions	Min.	Typ.	Max.	Unit
<b>Off characteristics</b>						
$BV_{DSS}$	Drain to source breakdown voltage	$V_{GS}=0V, I_D=250\mu A$	650			V
$\Delta BV_{DSS} / \Delta T_J$	Breakdown voltage temperature coefficient	$I_D=250\mu A$ , referenced to $25^\circ\text{C}$		0.67		V/ $^\circ\text{C}$
$I_{DSS}$	Drain to source leakage current	$V_{DS}=650V, V_{GS}=0V$			1	$\mu A$
		$V_{DS}=520V, T_C=125^\circ\text{C}$			50	$\mu A$
$I_{GSS}$	Gate to source leakage current, forward	$V_{GS}=30V, V_{DS}=0V$			100	nA
	Gate to source leakage current, reverse	$V_{GS}=-30V, V_{DS}=0V$			-100	nA
<b>On characteristics</b>						
$V_{GS(TH)}$	Gate threshold voltage	$V_{DS}=V_{GS}, I_D=250\mu A$	2		5	V
$R_{DS(ON)}$	Drain to source on state resistance	$V_{GS}=10V, I_D=8A$		0.23	0.25	$\Omega$
$G_{fs}$	Forward transconductance	$V_{DS}=30V, I_D=8A$		10		S
<b>Dynamic characteristics</b>						
$C_{iss}$	Input capacitance	$V_{GS}=0V, V_{DS}=200V, f=1\text{MHz}$		1530		pF
$C_{oss}$	Output capacitance			62		
$C_{rss}$	Reverse transfer capacitance			2.6		
$t_{d(on)}$	Turn on delay time	$V_{DS}=325V, I_D=16A, R_G=25\Omega, V_{GS}=10V$ (note 4,5)		21		ns
$t_r$	Rising time			48		
$t_{d(off)}$	Turn off delay time			77		
$t_f$	Fall time			35		
$Q_g$	Total gate charge	$V_{DS}=520V, V_{GS}=10V, I_D=16A$ (note 4,5)		43		nC
$Q_{gs}$	Gate-source charge			13		
$Q_{gd}$	Gate-drain charge			19		

### Source to drain diode ratings characteristics

Symbol	Parameter	Test conditions	Min.	Typ.	Max.	Unit
$I_S$	Continuous source current	Integral reverse p-n Junction diode in the MOSFET			16	A
$I_{SM}$	Pulsed source current				64	A
$V_{SD}$	Diode forward voltage drop.	$I_S=16A, V_{GS}=0V$			1.4	V
$t_{rr}$	Reverse recovery time	$I_S=16A, V_{GS}=0V,$ $di_f/dt=100A/\mu s$		347		ns
$Q_{rr}$	Reverse recovery charge				5.6	$\mu C$

※. Notes

1. Repetitive rating : pulse width limited by junction temperature.
2.  $L = 37.5\text{mH}, I_{AS} = 4A, V_{DD} = 50V, R_G=25\Omega$ , Starting  $T_J = 25^\circ\text{C}$
3.  $I_{SD} \leq 16A, di/dt = 100A/\mu s, V_{DD} \leq BV_{DSS}$ , Starting  $T_J = 25^\circ\text{C}$
4. Pulse Test : Pulse Width  $\leq 300\mu s$ , duty cycle  $\leq 2\%$
5. Essentially independent of operating temperature.

**Fig. 1. On-state characteristics**

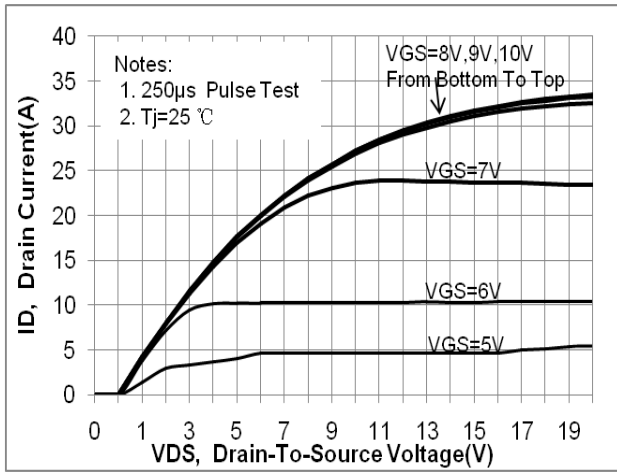

**Fig. 2. On-resistance variation vs. drain current and gate voltage**

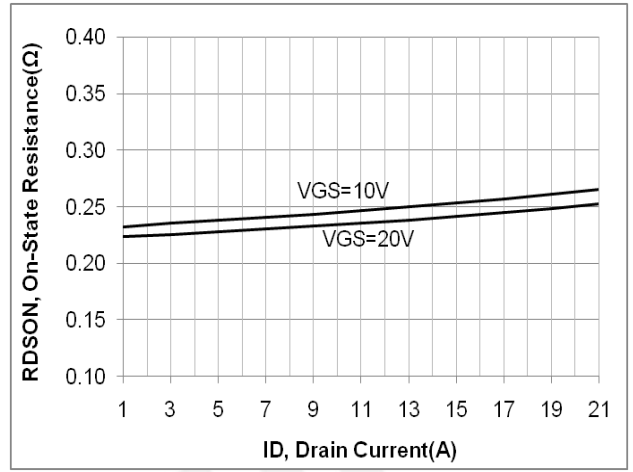

**Fig. 3. Gate charge characteristics**

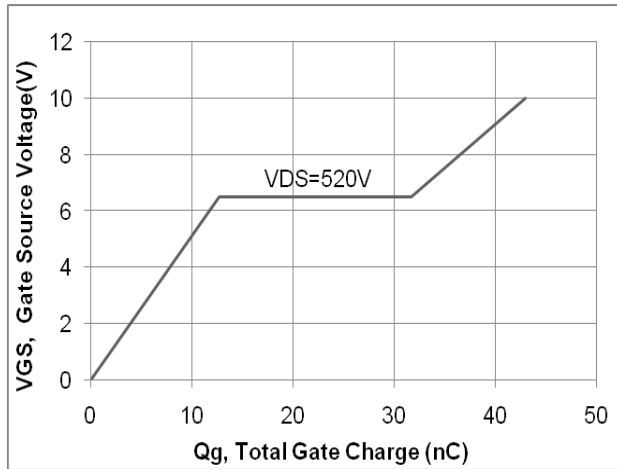

**Fig. 4. On state current vs. diode forward voltage**

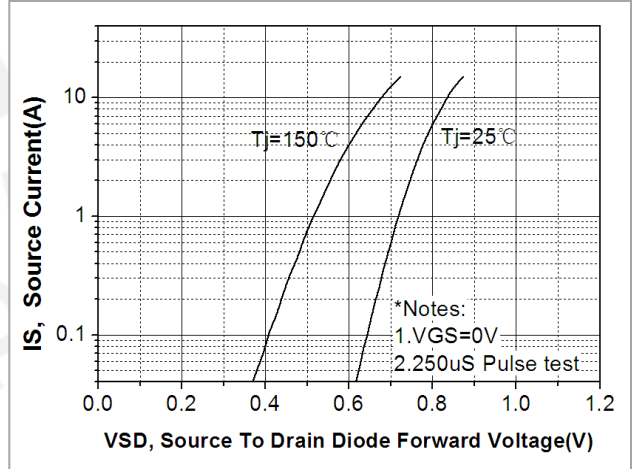

**Fig 5. Breakdown Voltage Variation vs. Junction Temperature**

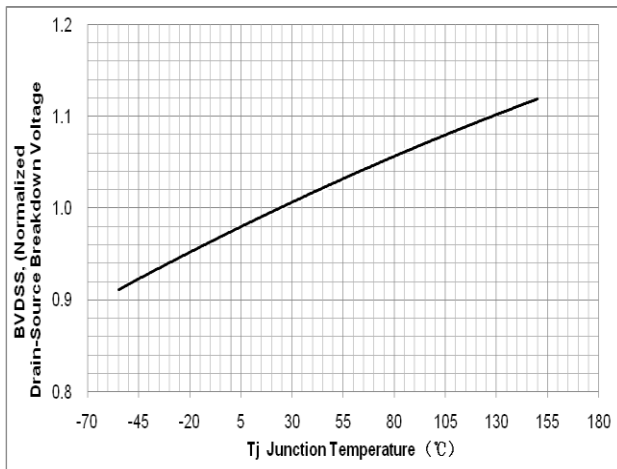

**Fig. 6. On resistance variation vs. junction temperature**

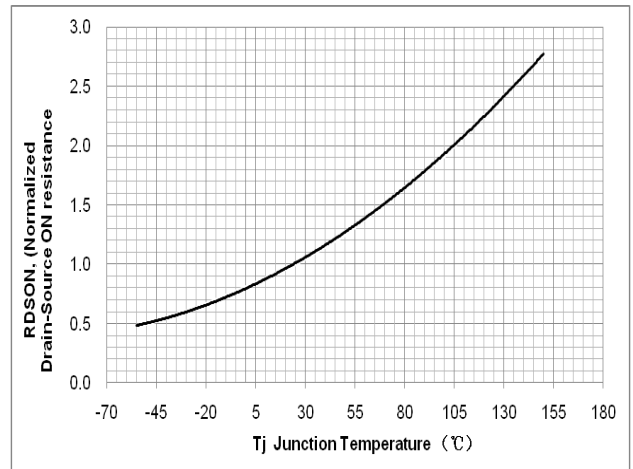

Fig. 7. Maximum safe operating area(TO-220)

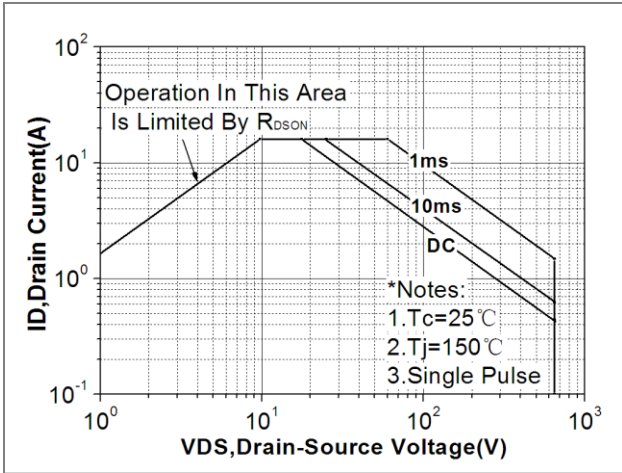

Fig. 8. Maximum safe operating area(TO-220F)

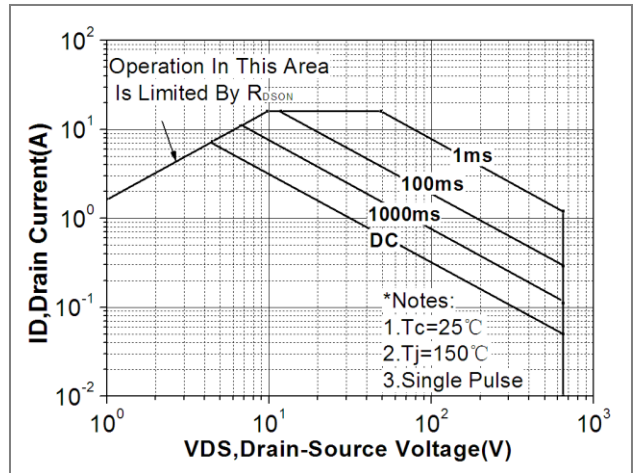

Fig. 9. Maximum safe operating area(TO-263)

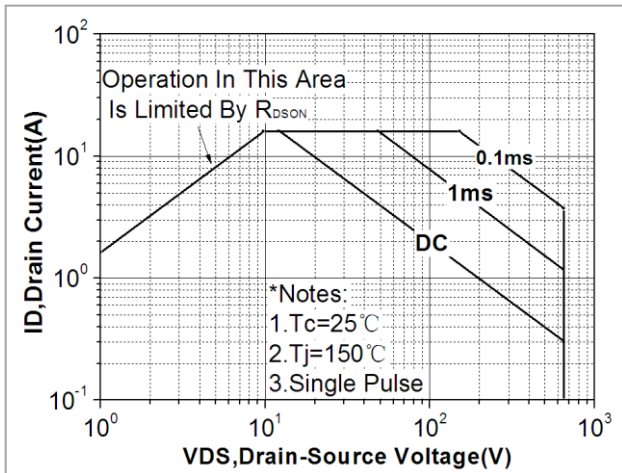

Fig. 10. Capacitance Characteristics

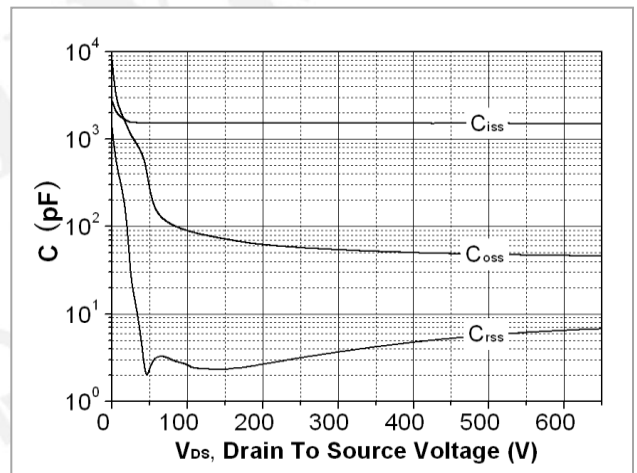

Fig. 11. Transient thermal response curve(TO-220)

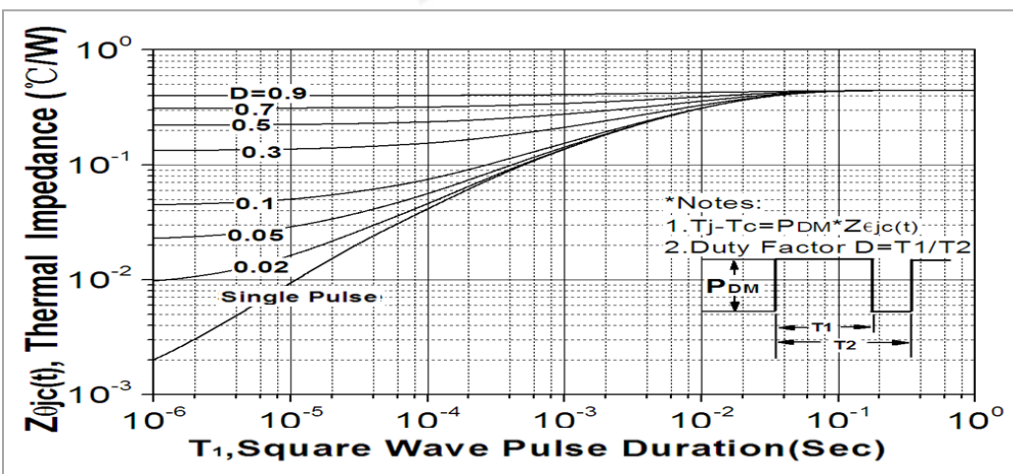

Fig. 12. Transient thermal response curve(TO-220F)

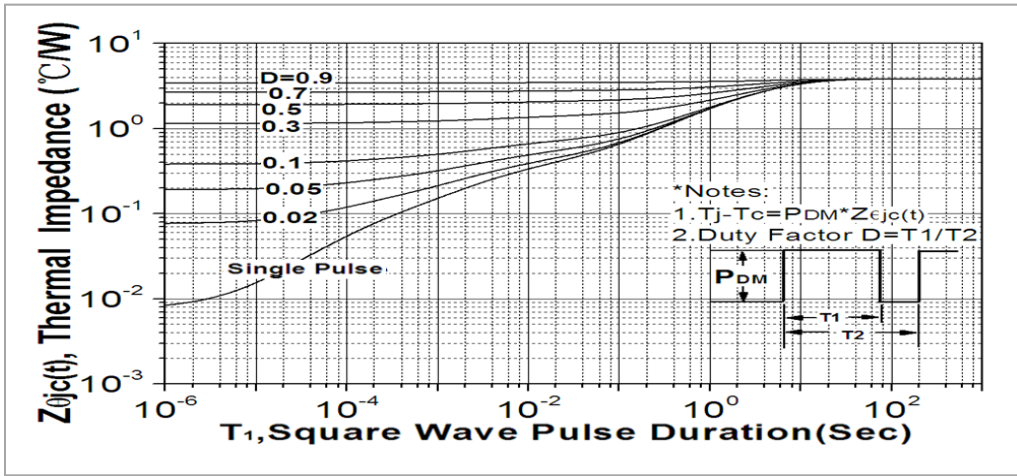

Fig. 13. Transient thermal response curve(TO-263)

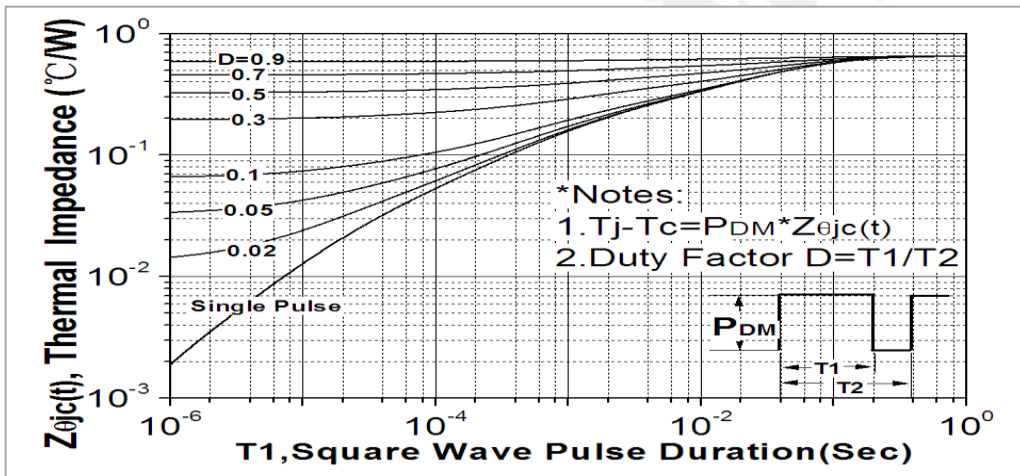

Fig. 14. Gate charge test circuit & waveform

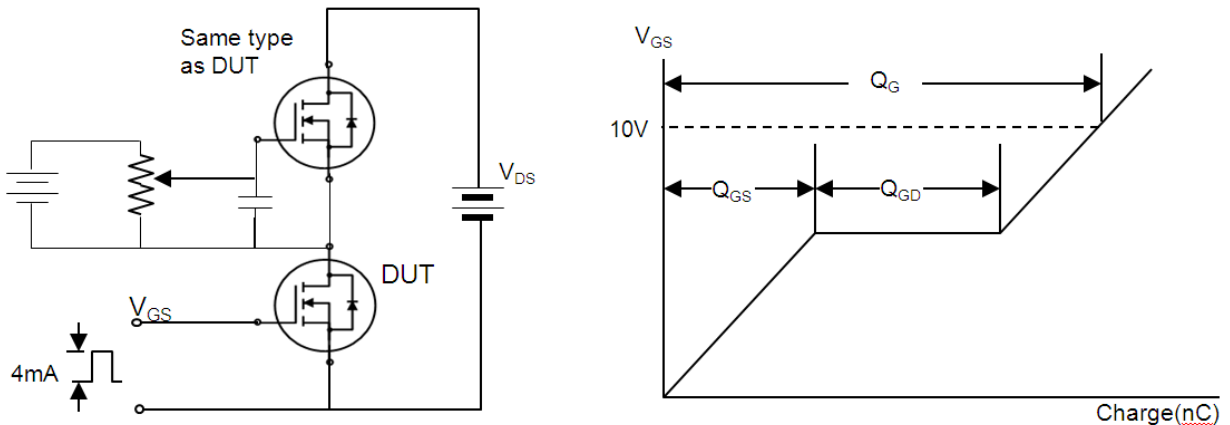

Fig. 15. Switching time test circuit & waveform

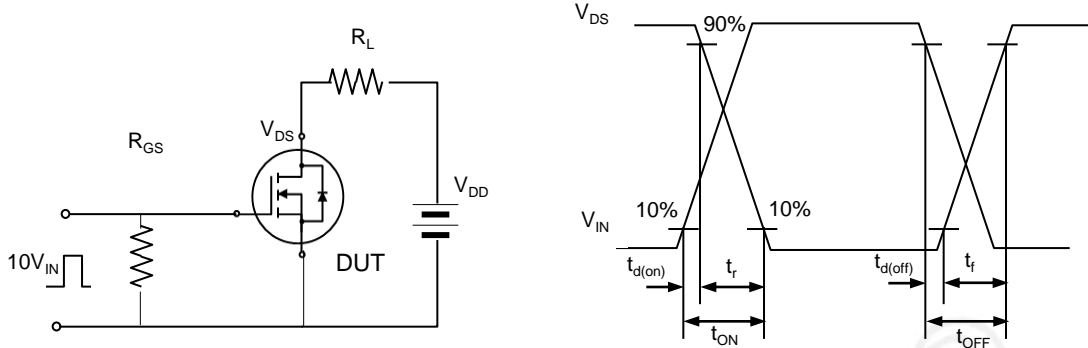

Fig. 16. Unclamped Inductive switching test circuit & waveform

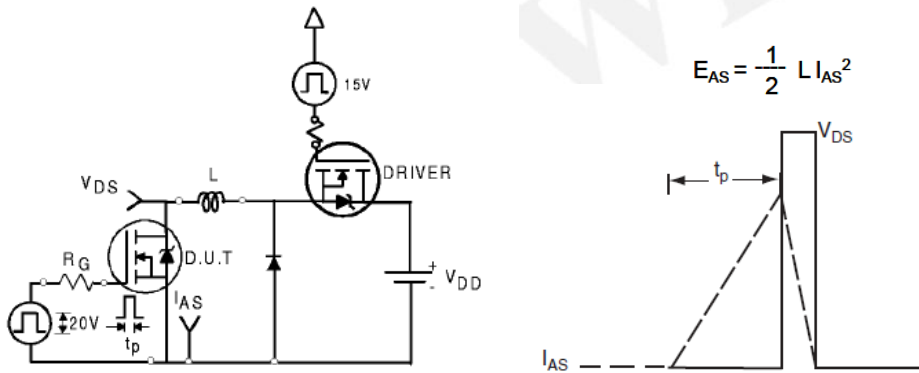
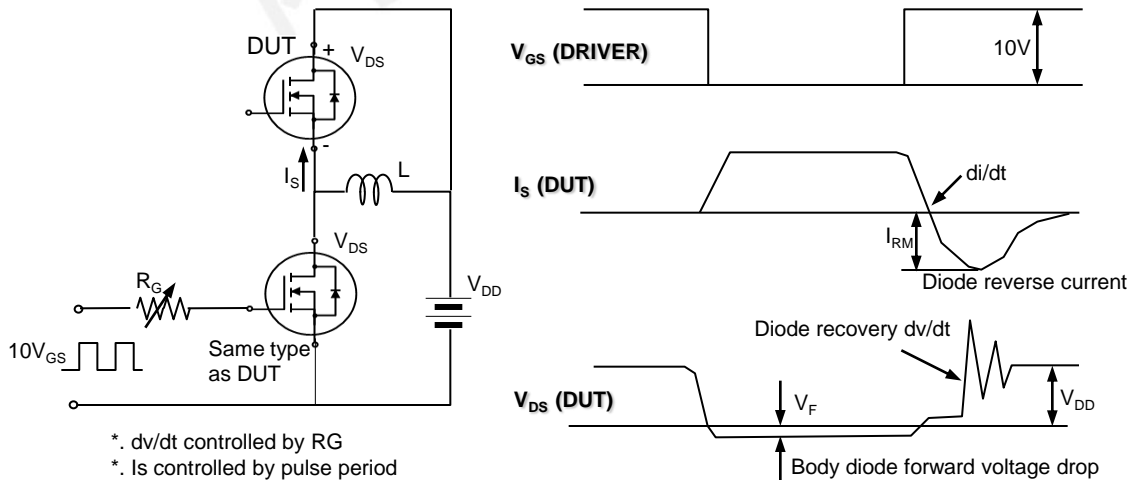

Fig. 17. Peak diode recovery dv/dt test circuit & waveform



Samwin®  
内部保密

### DISCLAIMER

\* All the data & curve in this document was tested in XI' AN SEMIPOWER TESTING & APPLICATION CENTER.

\* This product has passed the PCT,TC,HTRB,HTGB,HAST,PC and Solderdunk reliability testing.

\* Qualification standards can also be found on the Web site (<http://www.semipower.com.cn>)

\* Suggestions for improvement are appreciated, Please send your suggestions to [samwin@winsemi.com](mailto:samwin@winsemi.com)

## X-ON Electronics

Largest Supplier of Electrical and Electronic Components

*Click to view similar products for [MOSFET](#) category:*

*Click to view products by [Sam&wing](#) manufacturer:*

Other Similar products are found below :

[614233C](#) [648584F](#) [MCH3443-TL-E](#) [MCH6422-TL-E](#) [FDPF9N50NZ](#) [FW216A-TL-2W](#) [FW231A-TL-E](#) [APT5010JVR](#) [NTNS3A92PZT5G](#)  
[IRF100S201](#) [JANTX2N5237](#) [2SK2464-TL-E](#) [2SK3818-DL-E](#) [FCA20N60\\_F109](#) [FDZ595PZ](#) [STD6600NT4G](#) [FSS804-TL-E](#) [2SJ277-DL-E](#)  
[2SK1691-DL-E](#) [2SK2545\(Q,T\)](#) [D2294UK](#) [405094E](#) [423220D](#) [MCH6646-TL-E](#) [TPCC8103,L1Q\(CM](#) [367-8430-0972-503](#) [VN1206L](#)  
[424134F](#) [026935X](#) [051075F](#) [SBVS138LT1G](#) [614234A](#) [715780A](#) [NTNS3166NZT5G](#) [751625C](#) [873612G](#) [IRF7380TRHR](#)  
[IPS70R2K0CEAKMA1](#) [RJK60S3DPP-E0#T2](#) [RJK60S5DPK-M0#T0](#) [APT5010JVFR](#) [APT12031JFLL](#) [APT12040JVR](#) [DMN3404LQ-7](#)  
[NTE6400](#) [JANTX2N6796U](#) [JANTX2N6784U](#) [JANTXV2N5416U4](#) [SQM110N05-06L-GE3](#) [SIHF35N60E-GE3](#)