



Description

JMT P-channel MOSFET

Features

- $V_{DS} = -20V$, $I_D = -3A$
- $R_{DS(ON)} < 90m\Omega$ @ $V_{GS} = -4.5V$
 $R_{DS(ON)} < 120m\Omega$ @ $V_{GS} = -2.5V$
- High Power and Current Handling Capability
- Lead Free Product is Acquired
- Surface Mount Package

Application

- PWM Applications
- Load Switch
- Power Management

Package



SOT-23

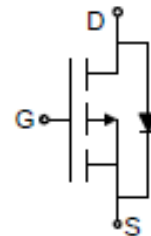

Absolute Maximum Ratings (T_C=25°C unless otherwise specified)

Symbol	Parameter	Max.	Units
V _{DSS}	Drain-Source Voltage	-20	V
V _{GSS}	Gate-Source Voltage	±12	V
I _D	Continuous Drain Current	T _C = 25°C	-3
		T _C = 100°C	-2
I _{DM}	Pulsed Drain Current ^{note1}	-10	A
P _D	Power Dissipation	1	W
R _{θJA}	Thermal Resistance, Junction to Ambient	125	°C/W
T _J , T _{STG}	Operating and Storage Temperature Range	-55 to +150	°C



Electrical Characteristics (T_C=25°C unless otherwise specified)

Symbol	Parameter	Test Condition	Min.	Typ.	Max.	Units
Off Characteristic						
V _{(BR)DSS}	Drain-Source Breakdown Voltage	V _{GS} =0V, I _D = -250μA	-20	-24	-	V
I _{DSS}	Zero Gate Voltage Drain Current	V _{DS} = -20V, V _{GS} = 0V,	-	-	-1	μA
I _{GSS}	Gate to Body Leakage Current	V _{DS} =0V, V _{GS} = ±12V	-	-	±100	nA
On Characteristics						
V _{GS(th)}	Gate Threshold Voltage	V _{DS} = V _{GS} , I _D = -250μA	-0.5	-0.7	-1.0	V
R _{DSON}	Static Drain-Source on-Resistance <small>note2</small>	V _{GS} =-4.5V, I _D =-3A	-	65	90	mΩ
		V _{GS} =-2.5V, I _D =-2A	-	89	120	
g _{FS}	Forward Transconductance	V _{DS} =-5V, I _D = -2A	5	-	-	S
Dynamic Characteristics						
C _{iss}	Input Capacitance	V _{DS} = -10V, V _{GS} = 0V, f = 1.0MHz	-	405	-	pF
C _{oss}	Output Capacitance		-	75	-	pF
C _{rss}	Reverse Transfer Capacitance		-	55	-	pF
Q _g	Total Gate Charge	V _{DS} = -10V, I _D = -3A, V _{GS} = -2.5V	-	3.3	12	nC
Q _{gs}	Gate-Source Charge		-	0.7	-	nC
Q _{gd}	Gate-Drain("Miller") Charge		-	1.3	-	nC
Switching Characteristics						
t _{d(on)}	Turn-on Delay Time	V _{DD} = -10V, I _D = -1A, R _{GEN} =10Ω, V _{GE} =-4.5V,	-	11	-	ns
t _r	Turn-on Rise Time		-	35	-	ns
t _{d(off)}	Turn-off Delay Time		-	30	-	ns
t _f	Turn-off Fall Time		-	10	-	ns
Drain-Source Diode Characteristics and Maximum Ratings						
I _S	Maximum Continuous Drain to Source Diode Forward Current		-	-	-3	A
I _{SM}	Maximum Pulsed Drain to Source Diode Forward Current		-	-	-10	A
V _{SD}	Drain to Source Diode Forward Voltage	V _{GS} = 0V, I _S = -1.3A	-	-	-1.2	V

Notes:1. Repetitive Rating: Pulse Width Limited by Maximum Junction Temperature

2. Pulse Test: Pulse Width≤300μs, Duty Cycle≤2%



Typical Performance Characteristics

Figure 1: Output Characteristics

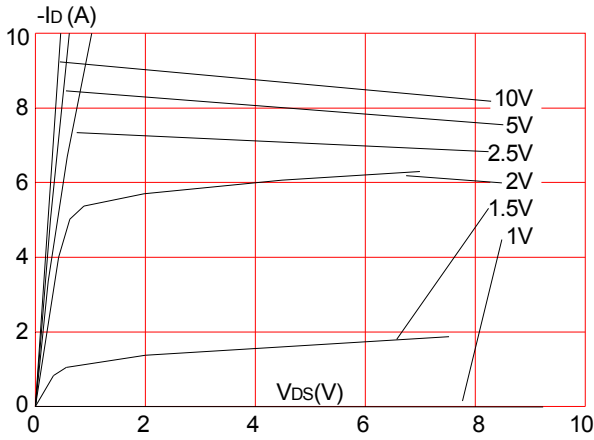

Figure 2: Typical Transfer Characteristics

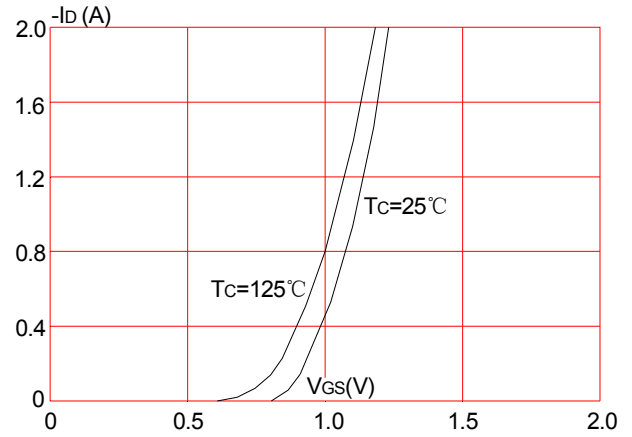

Figure 3: On-resistance vs. Drain Current

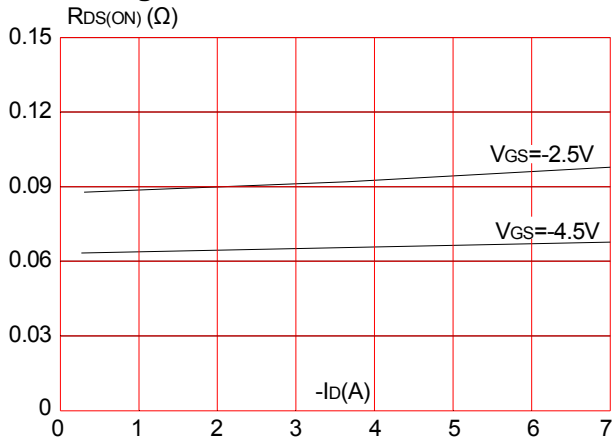

Figure 4: Body Diode Characteristics

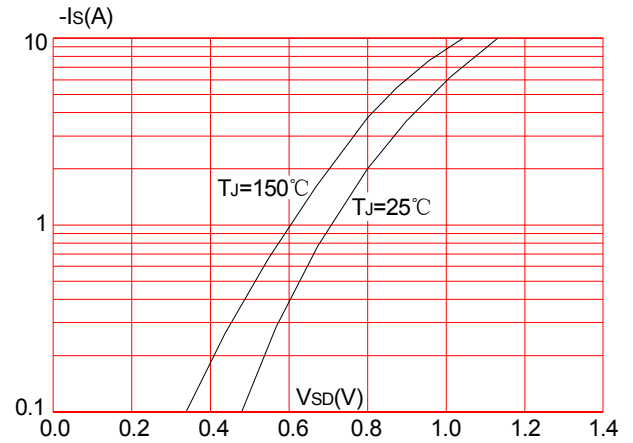

Figure 5: Gate Charge Characteristics

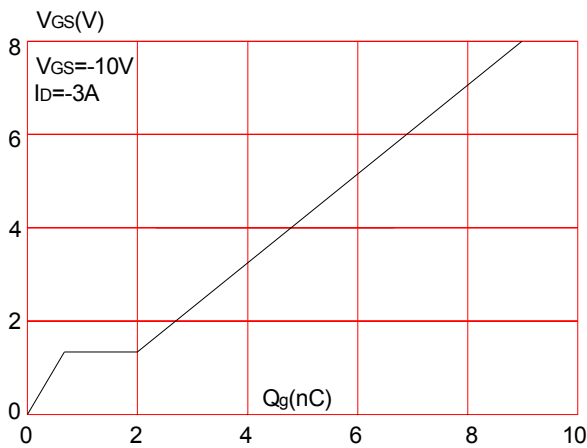

Figure 6: Capacitance Characteristics

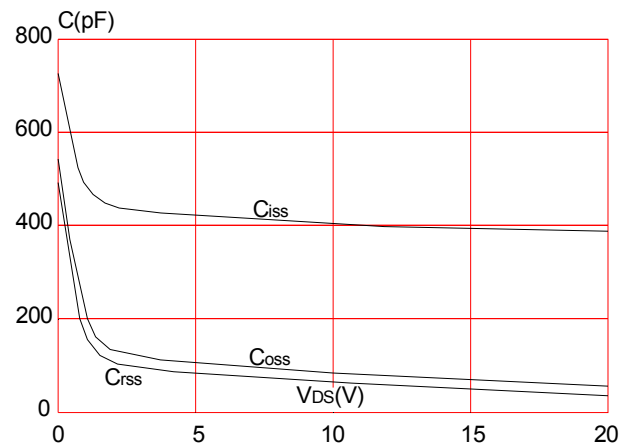



Figure 7: Normalized Breakdown Voltage vs. Junction Temperature

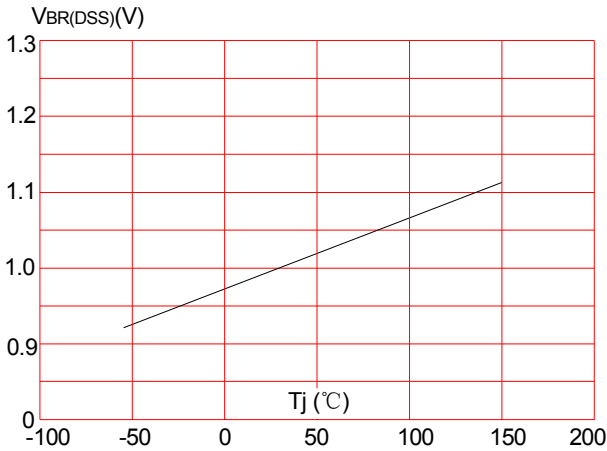

Figure 8: Normalized on Resistance vs. Junction Temperature

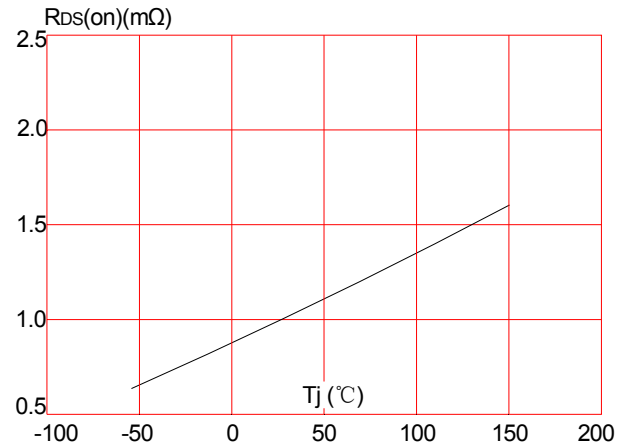

Figure 9: Maximum Safe Operating Area

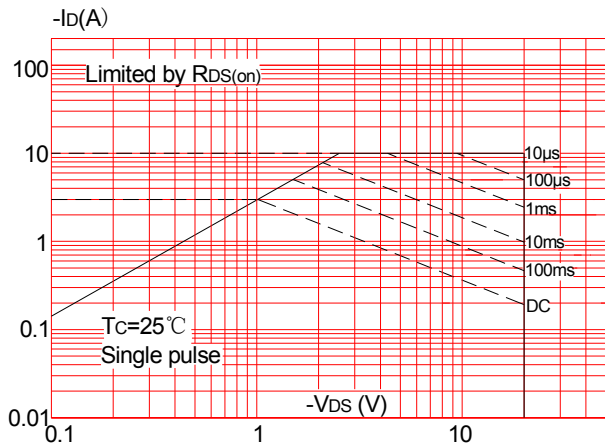

Figure 10: Maximum Continuous Drain Current vs. Case Temperature

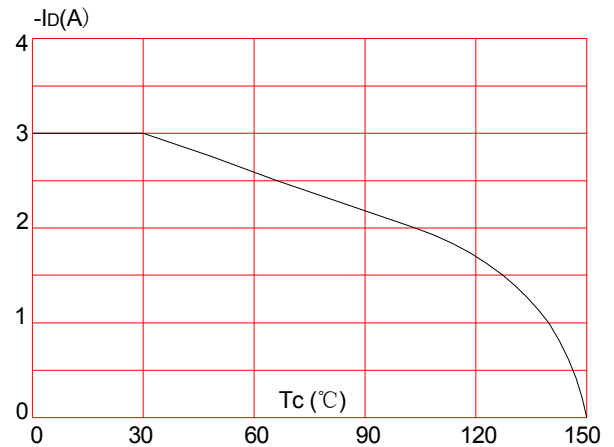
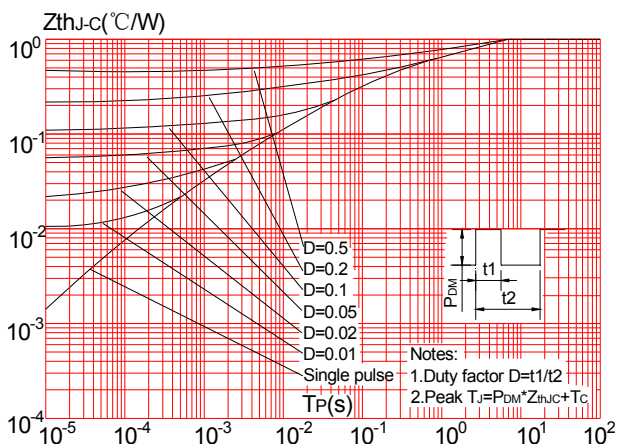

Figure.11: Maximum Effective Transient Thermal Impedance, Junction-to-Case (SOT-23)



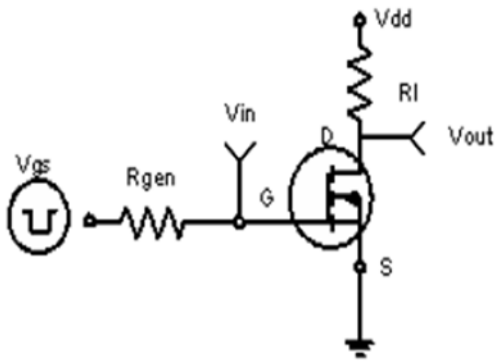

Figure1:Switching Test Circuit

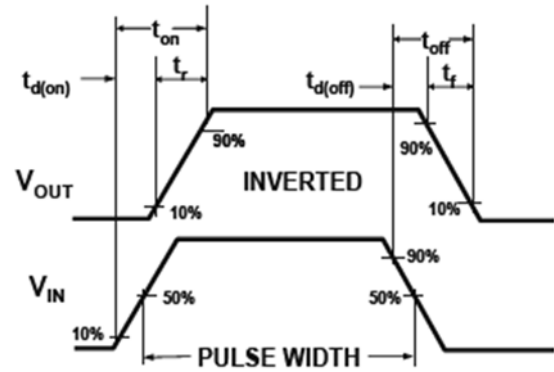
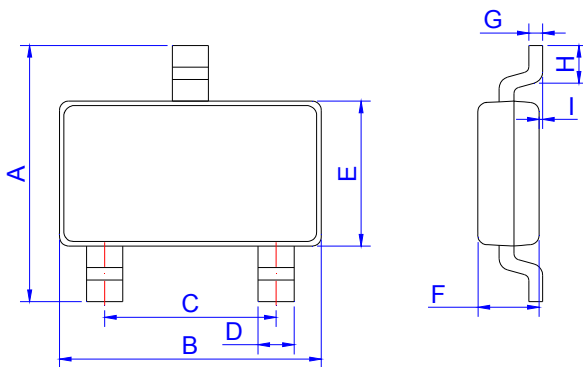

Figure2:Switching Waveforms

Package Mechanical Data



SOT-23

Ref.	Dimensions					
	Millimeters			Inches		
	Min.	Typ.	Max.	Min.	Typ.	Max.
A	2.30	2.40	2.50	0.091	0.095	0.098
B	2.80	2.90	3.00	0.110	0.114	0.118
C	1.90 REF			0.075 REF		
D	0.35	0.40	0.45	0.014	0.016	0.018
E	1.20	1.30	1.40	0.047	0.051	0.055
F	0.90	1.00	1.10	0.035	0.039	0.043
G		0.10	0.15		0.004	0.006
H	0.20			0.008		
I	0		0.10	0		0.004

Marking

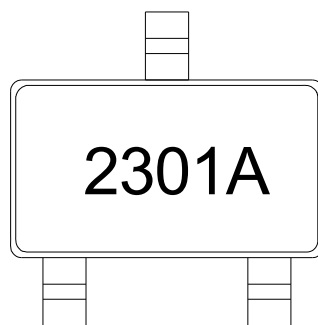

2301A: Device Code

Package Information-SOT-23

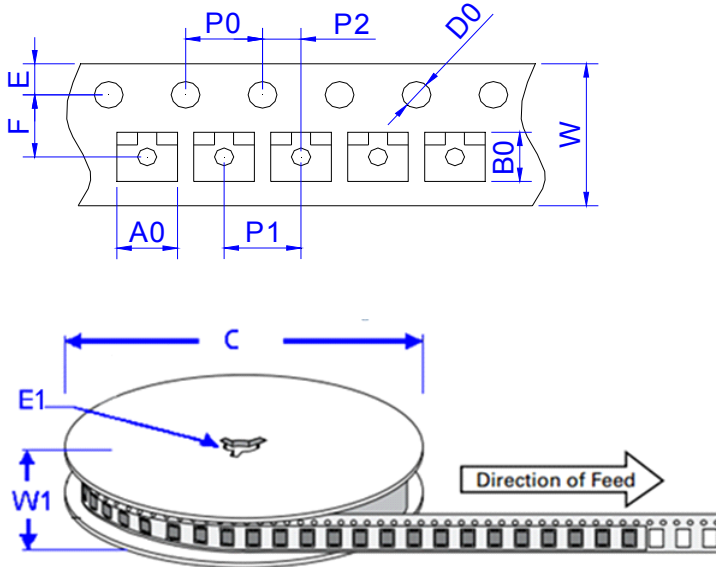

Ref.	Dimensions	
	Millimeters	Inches
A0	3.15 ± 0.3	0.124 ± 0.012
B0	2.77 ± 0.3	0.109 ± 0.012
C	178	7.0
D0	1.50±0.1	0.059 ± 0.004
E	1.75 ± 0.2	0.069 ± 0.008
E1	13.3±0.3	0.524± 0.012
F	3.5 ± 0.2	0.138 ± 0.008
P0	4.00 ± 0.2	0.157 ± 0.008
P1	4.00 ± 0.2	0.157 ± 0.008
P2	2.00 ± 0.2	0.079 ± 0.008
W	8.00 ± 0.2	0.315 ± 0.008
W1	11.5±1.0	0.453 ± 0.039

Ordering Information-SOT-23

OUTLINE	PACKAGE TYPE	QUANTITY REEL	DESCRIPTION
TAPING	SOT-23	3,000pcs	7 inch reel pack

Information furnished in this document is believed to be accurate and reliable. However, Jiangsu JieJie Microelectronics Co.,Ltd assumes no responsibility for the consequences of use without consideration for such information nor use beyond it.

Information mentioned in this document is subject to change without notice, apart from that when an agreement is signed, Jiangsu JieJie complies with the agreement.

Products and information provided in this document have no infringement of patents. Jiangsu JieJie assumes no responsibility for any infringement of other rights of third parties which may result from the use of such products and information.

This document is the fourth version which is made in 25-July-2018. This document supersedes and replaces all information previously supplied.



is a registered trademark of Jiangsu JieJie Microelectronics Co.,Ltd.

Copyright ©2018 Jiangsu JieJie Microelectronics Co.,Ltd. Printed All rights reserved.

X-ON Electronics

Largest Supplier of Electrical and Electronic Components

Click to view similar products for [MOSFET](#) category:

Click to view products by [JieJie](#) manufacturer:

Other Similar products are found below :

[614233C](#) [648584F](#) [MCH3443-TL-E](#) [MCH6422-TL-E](#) [FDPF9N50NZ](#) [FW216A-TL-2W](#) [FW231A-TL-E](#) [APT5010JVR](#) [NTNS3A92PZT5G](#)
[IRF100S201](#) [JANTX2N5237](#) [2SK2464-TL-E](#) [2SK3818-DL-E](#) [FCA20N60_F109](#) [FDZ595PZ](#) [STD6600NT4G](#) [FSS804-TL-E](#) [2SJ277-DL-E](#)
[2SK1691-DL-E](#) [2SK2545\(Q,T\)](#) [D2294UK](#) [405094E](#) [423220D](#) [MCH6646-TL-E](#) [TPCC8103,L1Q\(CM](#) [367-8430-0972-503](#) [VN1206L](#)
[424134F](#) [026935X](#) [051075F](#) [SBVS138LT1G](#) [614234A](#) [715780A](#) [NTNS3166NZT5G](#) [751625C](#) [873612G](#) [IRF7380TRHR](#)
[IPS70R2K0CEAKMA1](#) [RJK60S3DPP-E0#T2](#) [RJK60S5DPK-M0#T0](#) [APT5010JVFR](#) [APT12031JFLL](#) [APT12040JVR](#) [DMN3404LQ-7](#)
[NTE6400](#) [JANTX2N6796U](#) [JANTX2N6784U](#) [JANTXV2N5416U4](#) [SQM110N05-06L-GE3](#) [SIHF35N60E-GE3](#)