 Hollyland (China) Electronics Technology Corporation Ltd. Hollyland (XiaMen) Technology Corporation Ltd.	<b>PRODUCT SPECIFICATION</b>	ISSUED DATE:	2018/03/16
	20N RoHS & Pb-Free SERIES	REV. NO.:	A03
		DOC. NO.:	HLD-PSI-8097
		PAGE:	Page 1 of 9

制定 PREPARED BY		审核 CHECKED BY		批准 APPROVED BY	
-------------------	---	------------------	---	-------------------	---

1. 适用范围 SCOPE

本规格书适用于公司生产并获得 UL、CSA、PSE、CCC 认证的 20N ( $I_n \geq 800\text{mA}$ ) RoHS & Pb-Free 系列 HOLLY® 商标的超小型快速熔断保险丝管。

This specification defines the technical requirements of micro-fuse quick-acting type 20N ( $I_n \geq 800\text{mA}$ ) RoHS & Pb-Free series with HOLLY® brand, which has been approved by UL, CSA, PSE and CCC.

产品部件号为:            型号            额定电流            额定电压

Construction of Part No.: Type            Rated Current            Rated Voltage

例如 For Example: 20N            010            H/L

额定电压 Rated Voltage: H---250V

L---125V (800mA--10A)/ 72V (12A--15A)/ 60V (20A)

产品部件号 PART NUMBER

产品部件 Part Number	额定电流 Rated Current	额定电压 Rated Voltage	产品部件 Part Number	额定电流 Rated Current	额定电压 Rated Voltage	
<b>20N-0125H/L</b>	<b>125mA</b>	250V/125V	20N-040H/L	4A	250V/125V	
20N-0800H/L	800mA		20N-050H/L	5A		
20N-010H/L	1A		20N-060H/L	6A		
20N-012H/L	1.2A		20N-063H/L	6.3A		
20N-013H/L	1.25A		20N-070H/L	7A		
20N-015H/L	1.5A		20N-080H/L	8A		
20N-016H/L	1.6A		20N-090H/L	9A		
20N-020H/L	2A		20N-100H/L	10A		
20N-023H/L	2.25A		20N-120L	12A		72V
20N-025H/L	2.5A		20N-150L	15A		
20N-030H/L	3A		20N-200L	20A		60V
20N-032H/L	3.15A					
20N-035H/L	3.5A					

2. 相关标准及认证情况 APPLICABLE STANDARDS & APPROVED DETAILS

2.1 相关标准 APPLICABLE STANDARDS

UL 248-1, UL 248-14, CSA C22.2 No. 248.1-00, CSA C22.2 No. 248.14-00, JIS C 6575, GB 9364-1, GB 9364-3.

2.2 认证情况 APPROVED DETAILS

额定电压 RATED VOLTAGE	UL			CSA		PSE		CCC	
	UL 认证范围 APPROVED RANGE	UR 认证范围 APPROVED RANGE	认证 号码 CERT. NO.	认证范围 APPROVED RANGE	认证 号码 CERT. NO.	认证范围 APPROVED RANGE	认证 号码 CERT. NO.	认证范围 APPROVED RANGE	认证 号码 CERT. NO.
250V <sub>ac</sub>	800mA-3A	3.15A-10A	E156471	800mA-10A	LR101178	/	/	/	/
125V <sub>ac</sub>	800mA-3A (125V <sub>ac</sub> /V <sub>dc</sub> )	3.15A-10A (125V <sub>ac</sub> /V <sub>dc</sub> )				1A-5A	JET2489-31 007-1001	800mA-5A (125V <sub>ac</sub> /V <sub>dc</sub> )	2005010207 142039
72V <sub>ac</sub>	/	12A-15A		12A-15A		/	/	/	
60V <sub>dc</sub>	/	20A		/		/	/	/	

 Hollyland (China) Electronics Technology Corporation Ltd. Hollyland (XiaMen) Technology Corporation Ltd.	<b>PRODUCT SPECIFICATION</b>	ISSUED DATE:	2018/03/16
	20N RoHS & Pb-Free SERIES	REV. NO.:	A03
		DOC. NO.:	HLD-PSI-8097
		PAGE:	Page 2 of 9

### 3. 公司地址 ADDRESS

中国福建省厦门市翔安区舫山东二路 829 号  
829 Fangshan East 2nd Road, Xiang'an, Xiamen, China.

### 4. 外形与结构 DIMENSION & CONSTRUCTION

#### 4.1 外形尺寸 DIMENSION (单位 Unit: mm)

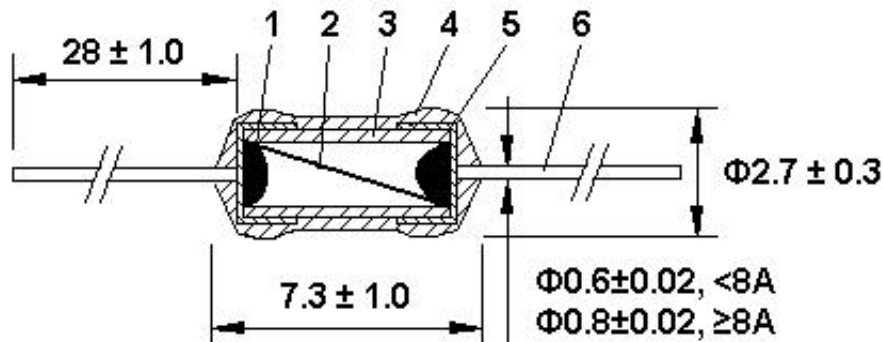

编号 No.	部 件 PARTS	材 料 MATERIALS	备 注 REMARK
1	焊锡 Solder	高温无铅焊锡 High Temperature Pb-Free Solder	符合 RoHS 指令要求 RoHS Compliant
2	可熔体 Fusible Element	金属丝 Alloy	符合 RoHS 指令要求 RoHS Compliant
3	管体 Tube	陶瓷管 Ceramic Tube	符合 RoHS 指令要求 RoHS Compliant
4	外涂层 Coating	环氧树脂 Epoxy Resin	符合 RoHS 指令要求, 满足 UL 94V-0 阻燃 RoHS Compliant, Flammability Rating: UL 94V-0
5	铜帽 Cap	黄铜 Brass	镀镍、镀锡, 符合 RoHS 指令要求 Nickel and Tin Plated, RoHS Compliant
6	尾线 Lead	铜镀锡 Tin Plated Copper	符合 RoHS 指令要求 RoHS Compliant

#### 4.2 陶瓷管 CERAMIC TUBE

陶瓷管必须无缺陷如破裂、缺损、污染。

The ceramic tube shall have no defects such as crack, injury and contamination.

#### 4.3 铜帽 CAP

铜帽应被固定牢固在管体两端, 以保证在未损坏熔断体时, 铜帽不能被卸下。铜帽表面应全部镀锡, 且确保镀锡层应牢固不易脱落, 每个端帽应能经受专用的设备外加的轴向拉力 5N, 保持 1 分钟。

Cap should be firmly attached to the both ends of the tube so that it is not possible to remove them without damaging the fuse itself. And it shall be sufficient for withstanding an axial pull of 5N applied to each cap for 1 minute. The cap shall be tin plated completely to assure that the plated layer is not easy to fall off.

#### 4.4 环氧树脂涂层 EPOXY RESIN COATING

环氧树脂涂层应均匀涂在管体表面, 并应光洁平整。

The epoxy resin coating for fuse-body shall be even and the surface of fuse-body should be smooth as well as clear.

 Hollyland (China) Electronics Technology Corporation Ltd. Hollyland (XiaMen) Technology Corporation Ltd.	<b>PRODUCT SPECIFICATION</b>	ISSUED DATE:	2018/03/16
	20N RoHS & Pb-Free SERIES	REV. NO.:	A03
		DOC. NO.:	HLD-PSI-8097
		PAGE:	Page 3 of 9

## 5. 机械特性 MECHANICAL PERFORMANCES

保险丝应能承受下列三项试验 Fuse shall withstand the following three tests:

### 5.1 扭力试验 ROTATIONAL STRENGTH TEST

固定保险丝的一端铜帽，然后在另一端铜帽上顺时针和逆时针方向上顺序施加 5N.mm 力矩，两端铜帽不应松动，陶瓷管也不应破碎。

When one end cap of the specimen is fixed and then the torque 5N.mm is applied to the other end cap clockwise and counterclockwise, no looseness of end cap at both ends or damage of fuse-tube shall occur.

### 5.2 拉力试验 TENSILE STRENGTH TEST

固定保险丝的一端铜帽，然后在另一端铜帽上，沿水平轴方向施加 5N 的拉力，两端铜帽不应松动且陶瓷管不应破碎。

When one end cap of the specimen is fixed and then the tensile force 5N is applied to the other end cap in a direction to separate the end caps, no looseness of end cap at both ends or damage of fuse-tube shall occur.

### 5.3 管子强度试验 STRENGTH OF FUSE-TUBE TEST

两端铜帽固定好后，在陶瓷管的中心位置施加 10N 的压力，陶瓷管不应破碎。

When both end caps of the specimen are fixed and then the force 10N is applied to the middle part of the fuse-tube, no damage of the fuse-tube shall occur.

## 6. 电气特性 ELECTRICAL PERFORMANCES

### 6.1 测试条件 TEST CONDITIONS

A. 全部测试条件都应在环境温度  $25 \pm 5^\circ\text{C}$  条件下进行，在此期间温度变化不允许达到  $5^\circ\text{C}$  和到极限范围。

All electrical tests shall be conducted at an ambient temperature of  $25 \pm 5^\circ\text{C}$ . The ambient temperature shall not vary more than  $5^\circ\text{C}$  during the test, and must be within these limits.

B. 每个保险丝应该按指定方式由一个单极掣保险丝管座支撑。管座应水平安装在不导电材质的测试板或测试台上，这样测试每个保险丝时才会有其水平轴线。如果测试板设定为测试两个或以上保险丝时，保险丝管座固定，且任何两个进行测试的保险丝所用的保险丝管座之间的间隙不能小于 6 英寸（152mm），保险丝管座与测试电路直接相连接的任何电流测试装置相连，及其与电源相连的连接线为 8 AWG (8.4mm<sup>2</sup>) 的标准通用铜线，任一与电源相连的连接线长度不能小于 4 英尺（1,219mm），测试夹具应保证在测试电路中每个保险丝尾线最小长度为 0.5 英寸(12.7mm)。

Each fuse shall be supported in the intended manner in a single pole fuse holder. Each fuse holder shall be mounted horizontally on a bench or test board of non-conducting material so that each fuse under test should have its major axis horizontal. If a test board is designed for the testing of two or more fuses in series, the fuse holders shall be so located that there will be a spacing of not less than 6 inches (152mm) between any two fuses under test. The fuse holder and any current measuring device connected directly to the test circuit shall be connected to each other and to the source of supply by means of 8 AWG (8.4mm<sup>2</sup>) standard, general-use copper wire. Any connection to the source of supply shall not to be less than 4 feet (1,219mm) long. The test fixture shall be so arranged that each end of the fuse have a 0.5 inches (12.7mm) minimum length of lead in the test circuit.

### 6.2 负载能力测试 CURRENT-CARRYING CAPACITY TEST

当保险丝通以 100%倍额定电流的条件下进行测试时，在 4 小时内电路不应断开，保险丝不被电流熔化，管壳不破裂和烧焦。

 <b>Hollyland (China) Electronics Technology Corporation Ltd.</b> Hollyland (XiaMen) Technology Corporation Ltd.	<b>PRODUCT SPECIFICATION</b>	ISSUED DATE:	2018/03/16
	20N RoHS & Pb-Free SERIES	REV. NO.:	A03
		DOC. NO.:	HLD-PSI-8097
		PAGE:	Page 4 of 9

When a fuse is carrying 100% of rated current for continuing 4 hours, no open circuit, melt fusible element, or ruptured tube shall occur in any manner during this test.

### 6.3 温度上升试验 TEMPERATURE RISING TEST

当保险丝通以 100%倍额定电流的条件下进行测试时，在达到热量平衡后，测量保险丝表面的温度，保险丝表面的温度上升必须等于或低于 75℃。

注：温度上升 = 保险丝表面的温度 - 环境温度

Measure the temperature of the surface of the fuse under the 100% of rated current, when the thermal equilibrium reaches. The temperature rise on the surface of each fuse shall be 75℃ or less.

Note: Temperature Rising = Fuse temperature - Ambient temperature

### 6.4 预飞弧时间/电流特性 PRE-ARCING TIME/CURRENT CHARACTERISTICS

当保险丝通以下表规定的电流时，其熔断时间必须符合下表的要求，且铜帽不能飞脱、陶瓷管不应破裂、损坏。

When the current in the following table is passing the fuse, its opening time must be in accordance with the requirements in the following table. Moreover, no damage of the fuse-tube or shattering of the cap shall occur.

%额定电流 % of Rated Current	熔断时间 Opening Time
100%	最快 4 小时 4 hours Min.
200%	最慢 20 秒 20 seconds Max.

### 6.5 分断能力 INTERRUPTING RATING

这些型号的保险丝的分断能力应能达到下表规定的相应的各种安全认证的分断能力要求。保险丝分断电路后，保险丝管不应破裂、铜帽飞脱、且铜帽两端的绝缘电阻不小于 0.1MΩ。

The interrupting rating should reach the interrupting current rating given in the following table. And after this test, there should be no damage of the fuse-tube or shattering of the caps. After this test, the insulation resistance between the end caps shall be not less than 0.1MΩ.

额定电压 RATED VOLTAGE	额定电流 RATED CURRENT	分断能力 INTERRUPTING RATING	额定电流 RATED CURRENT	分断能力 INTERRUPTING RATING	额定电流 RATED CURRENT	分断能力 INTERRUPTING RATING	额定电流 RATED CURRENT	分断能力 INTERRUPTING RATING	额定电流 RATED CURRENT	分断能力 INTERRUPTING RATING
	UL		UR		CSA▲		PSE		CCC	
60V <sub>dc</sub>			20A	50A						
72V <sub>ac</sub>			12A-15A	30A	12A-15A	30A				
125V <sub>ac</sub>	800mA-3A (125V <sub>ac</sub> / V <sub>dc</sub> )	50A	3.15A-10A (125V <sub>ac</sub> / V <sub>dc</sub> )	30A	100mA-10A	50A	1A-5A	100A	800mA-5A	50A(125V <sub>ac</sub> / V <sub>dc</sub> )
250V <sub>ac</sub>	375mA-3A	50A	100mA-315mA	30A	100mA-3A	25A				
			3.15A-10A		3.15A-10A	30A				

### 6.6 电阻测试 COLD RESISTANCE TEST

环境温度为 25±5℃，测试电流不大于保险丝额定电流的 10%。

Test current less than or equal to 10% of rated current to the fuse for cold resistance test at an ambient temperature of 25±5℃.

### 6.7 焊接参数 SOLDERING PARAMETERS

- 1) 波峰焊 Wave soldering ---260℃，最大 10 秒 10 sec. Maximum;
- 2) 手工焊 Manual soldering ---350℃，最大 5 秒 5 sec. Maximum.



Hollyland (China) Electronics  
Technology Corporation Ltd.  
Hollyland (XiaMen)  
Technology Corporation Ltd.

**PRODUCT SPECIFICATION**

20N RoHS & Pb-Free SERIES

ISSUED DATE:

REV. NO.:

DOC. NO.:

PAGE:

2018/03/16

A03

HLD-PSI-8097

Page 5 of 9

6.8 平均 I-T 特性曲线图(仅供参考) THE AVERAGE I-T CHARACTERISTICS CURVE (For Your Reference)

20N RoHS & Pb-Free 平均 I-T 曲线图(仅供参考)  
20N RoHS & Pb-Free AVERAGE I-T CHARACTERISTICS CURVE (FOR REFERENCE ONLY)

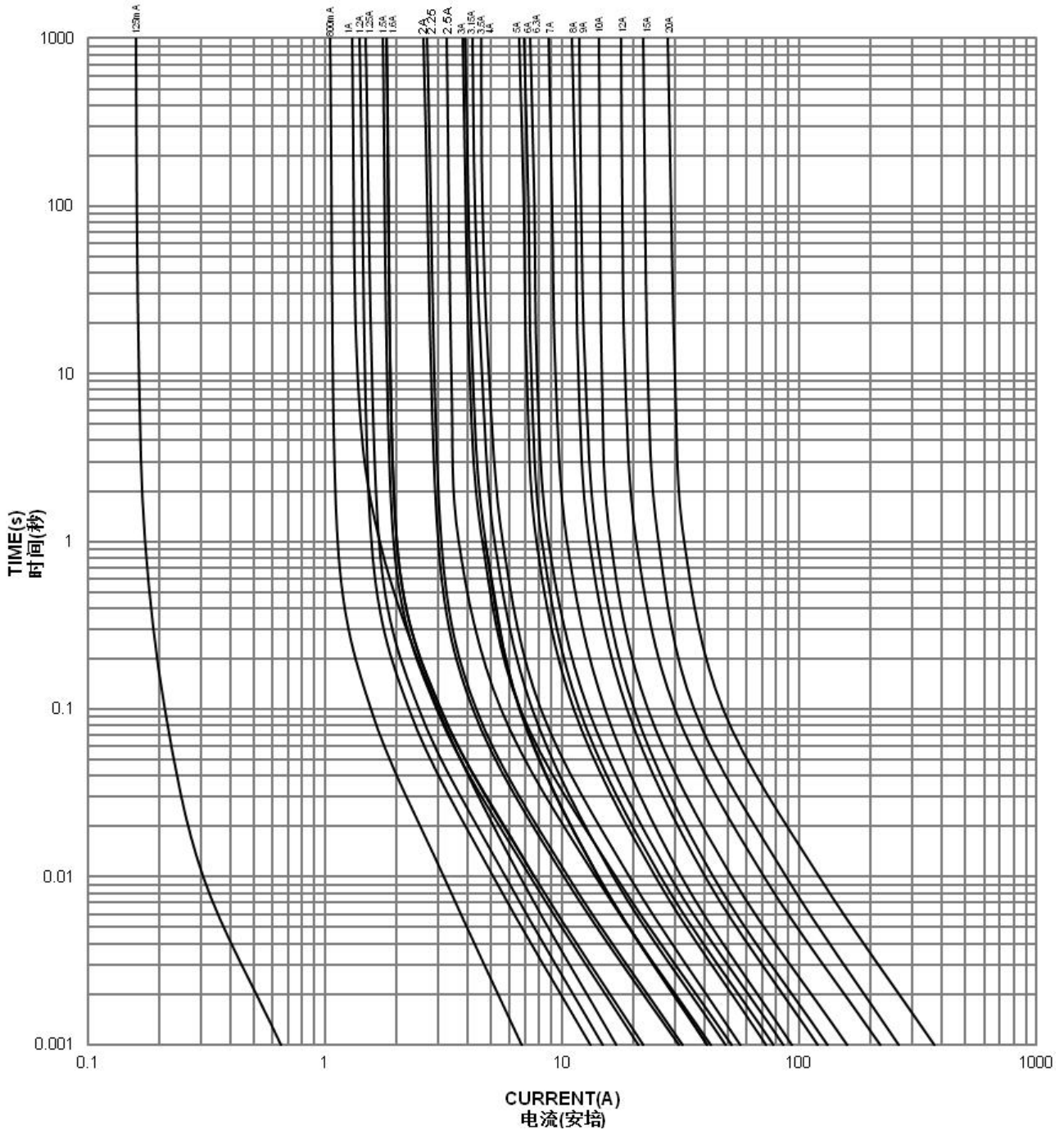



Hollyland (China) Electronics  
Technology Corporation Ltd.  
Hollyland (XiaMen)  
Technology Corporation Ltd.

**PRODUCT SPECIFICATION**

20N RoHS & Pb-Free SERIES

ISSUED DATE:

REV. NO.:

DOC. NO.:

PAGE:

2018/03/16

A03

HLD-PSI-8097

Page 6 of 9

6.9 平均 I<sup>2</sup>T-T 特性曲线图(仅供参考) THE AVERAGE I<sup>2</sup>T-T CHARACTERISTICS CURVE (For Your Reference)

**20N RoHS & Pb-Free Average I<sup>2</sup>T-T Characteristics Curve(For Reference Only)**

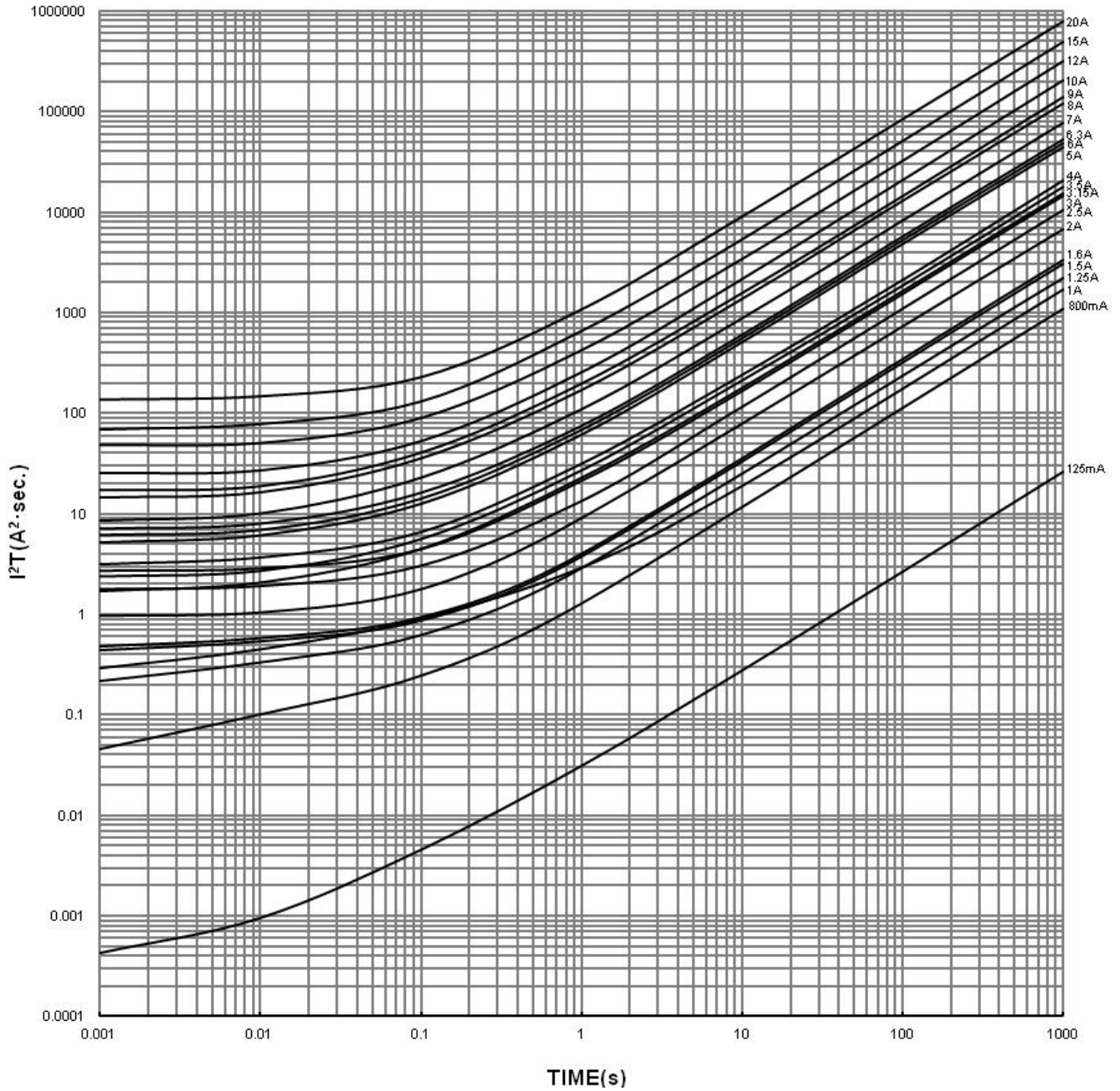

 Hollyland (China) Electronics Technology Corporation Ltd. Hollyland (XiaMen) Technology Corporation Ltd.	<b>PRODUCT SPECIFICATION</b>	ISSUED DATE:	2018/03/16
	20N RoHS & Pb-Free SERIES	REV. NO.:	A03
		DOC. NO.:	HLD-PSI-8097
		PAGE:	Page 7 of 9



## 7. 产品标志 MARKINGS

7.1 保险丝管表面封装蓝色环氧树脂，并印有相应的标志，标志应易于看清。

The relevant markings shall be marked on the blue epoxy resin coating of the fuse and shall be easily visible.

7.2 每个保险丝应标有下列标记：

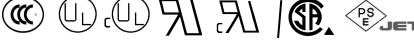
The markings for every fuse shall be prescribed as below according to the types:

- 1) 安全认证标志 Safety Approval Logo: 
- 2) 商标 Trademark: 
- 3) 额定电流 Rated Current

注：额定电压和型号名称在包装标签上标识。

Note: The rated voltage and type should be marked on the packing label.

## 8. 包装要求 PACKING DETAILS

编带采用轴向尾线编带方式，编带宽度为 64mm，每卷编带为 4,000 个保险丝管，也可按客户要求数量进行包装。

The product should be packed with axial leads taping. The inside taping spacing is 64mm. 4,000EA fuses per reel are taped in an inner box. The quantity can be followed as customer's requirements.

8.1 包装方式：4,000EA / 盒，10 盒 / 箱。

Packing Details: 4,000EA / Inner box; 10 Inner boxes / External carton

纸盒规格：长×宽×高=256×80×95mm;

外箱规格：长×宽×高=440×270×230mm.

Inner box dimension: Length×Width×Height=256×80×95mm;

External carton dimension: Length×Width×Height=420×270×230mm.

注：参考产品包装轴向尾线编带标准 EIA-296-F，见本规格书的最后一页。

Remark: Bibliography-Packing standard of production that files No. EIA-296-F, see the last page of this specification.

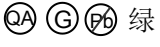
8.2 标签应包括：型号、额定电流、额定电压、额定分断电流、商标、安全标志、批量号码、公司标志、 绿色的签章、RoHS & Pb-Free 标志。

The label in the smallest packing in which the fuses are put shall contain the Type, Rated Current, Rated Voltage, Interrupting Rating, Safety Approval Logo, Lot No., Trademark,  seals in green, RoHS & Pb-Free mark.

例：批量号

For Example: Lot No.:

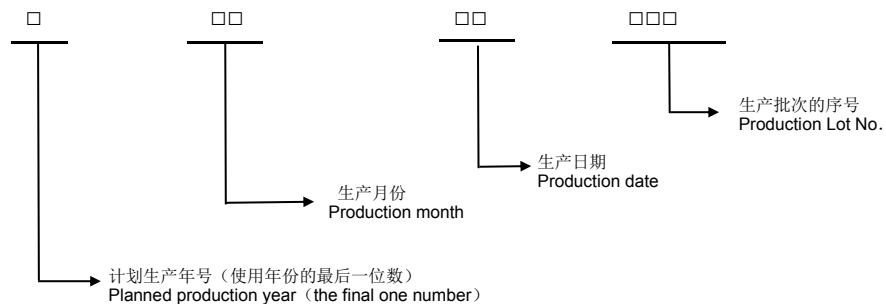

8.3 产品的包装应能达到防潮、抗振的作用。以防在运输或贮存过程中产品受潮或受损坏。

Packing shall meet the requirements of anti-moisture and anti-shaking so that the products will not absorb moisture or be damaged during transportation or storage.

## 9. 环境参数 ENVIRONMENTAL PARAMETERS

9.1 工作温度 Operating Temperature: -55℃~125℃.

9.2 储存温度 Storing Temperature: -55℃~85℃.

 Hollyland (China) Electronics Technology Corporation Ltd. Hollyland (XiaMen) Technology Corporation Ltd.	<b>PRODUCT SPECIFICATION</b>	ISSUED DATE:	2018/03/16
	20N RoHS & Pb-Free SERIES	REV. NO.:	A03
		DOC. NO.:	HLD-PSI-8097
		PAGE:	Page 8 of 9

### 10. 信赖性试验 RELIABILITY TEST

项目 Item	试验要求 Test Requirements	试验条件 Test Conditions
高温试验 High Temperature Test	<p>试验后保险丝管的电阻符合范围；电气特性符合： 200% <math>I_n \leq 20</math> 秒，100% <math>I_n \geq 4</math> 小时。</p> <p>After high temperature test, the resistance value of the fuses shall be in range. Electrical Characteristics: 200% <math>I_n \leq 20</math> seconds, 100% <math>I_n \geq 4</math> hours.</p>	<p>测试温度：105±2℃， 测试时间：1,000 小时。</p> <p>Test Temperature: 105±2℃, Test Time: 1,000 hours.</p>
低温试验 Low Temperature Test	<p>试验后保险丝管的电阻符合范围；电气特性符合： 200% <math>I_n \leq 20</math> 秒，100% <math>I_n \geq 4</math> 小时。</p> <p>After low temperature test, the resistance value of the fuses shall be in range. Electrical Characteristics: 200% <math>I_n \leq 20</math> seconds, 100% <math>I_n \geq 4</math> hours.</p>	<p>测试温度：-20±2℃， 测试时间：1,000 小时。</p> <p>Test Temperature: -20±2℃, Test Time: 1,000 hours.</p>
高湿试验 High Humidity Test	<p>试验后保险丝管的电阻符合范围；电气特性符合： 200% <math>I_n \leq 20</math> 秒，100% <math>I_n \geq 4</math> 小时。</p> <p>After high humidity test, the resistance value of the fuses shall be in range. Electrical Characteristics: 200% <math>I_n \leq 20</math> seconds, 100% <math>I_n \geq 4</math> hours.</p>	<p>测试温度：40±2℃， 测试湿度：90%~95%， 测试时间：96 小时。</p> <p>Test Temperature: 40±2℃, Test Humidity: 90%~95%, Test Time: 96 hours.</p>
热冲击试验 Thermal Shock Test	<p>试验后保险丝管的电阻符合范围；电气特性符合： 200% <math>I_n \leq 20</math> 秒，100% <math>I_n \geq 4</math> 小时。</p> <p>After thermal shock test, the resistance value of the fuses shall be in range. Electrical Characteristics: 200% <math>I_n \leq 20</math> seconds, 100% <math>I_n \geq 4</math> hours.</p>	<p>每个循环：-40℃放置 30 分钟后， 85℃放置 30 分钟，测试次数：10 循环。</p> <p>One cycle: -40℃ / 30mins → 85℃ / 30mins, Total: 10 cycles.</p>
落下、冲击试验 Falling Shock Test	<p>铜帽应固定牢固,以保证在未损坏熔断体时,铜帽不能被卸下。铜帽表面镀锡层应牢固不易脱落,每个端帽应能经受专用的设备外加的轴向拉力 5N,保持 1 分钟。陶瓷管必须无缺陷破裂、缺损和污染。试验后保险丝管的电阻符合范围；电气特性符合：200% <math>I_n \leq 20</math> 秒，100% <math>I_n \geq 4</math> 小时。</p> <p>Cap should be firmly attached to the both ends of the tube so that it is not possible to remove them without damaging the fuse itself. And it shall be sufficient for withstanding an axial pull of 5N applied to each cap for 1 minute. The tin plated layer is not easy to fall off. The ceramic tube shall have no defects such as crack, injury and contamination. After falling shock test, the resistance value of the fuses shall be in range. Electrical Characteristics: 200% <math>I_n \leq 20</math> seconds, 100% <math>I_n \geq 4</math> hours.</p>	<p>一箱 40,000 个保险丝管从 1 米高自由落下, 跌落 20 次。</p> <p>40,000EA fuses / one carton, Falling Height: 1 meter, Falling Times: 20 times.</p>
可焊性试验 Solderability Test	<p>试验后尾线表面的焊锡覆盖率&gt;95%。</p> <p>After solderability test, solder coverage of fuse's pig tail will be no more than 95%.</p>	<p>预涂助焊剂 5±1 秒后, 浸入 245±5℃的无铅焊锡 5±0.5 秒。</p> <p>Immerse to flux 5±1sec. then dip in solder bath 245±5℃, 5±0.5sec..</p>





Hollyland (China) Electronics  
Technology Corporation Ltd.  
Hollyland (XiaMen)  
Technology Corporation Ltd.

**PRODUCT SPECIFICATION**

20N RoHS & Pb-Free SERIES

ISSUED DATE:

2018/03/16

REV. NO.:

A03

DOC. NO.:

HLD-PSI-8097

PAGE:

Page 9 of 9

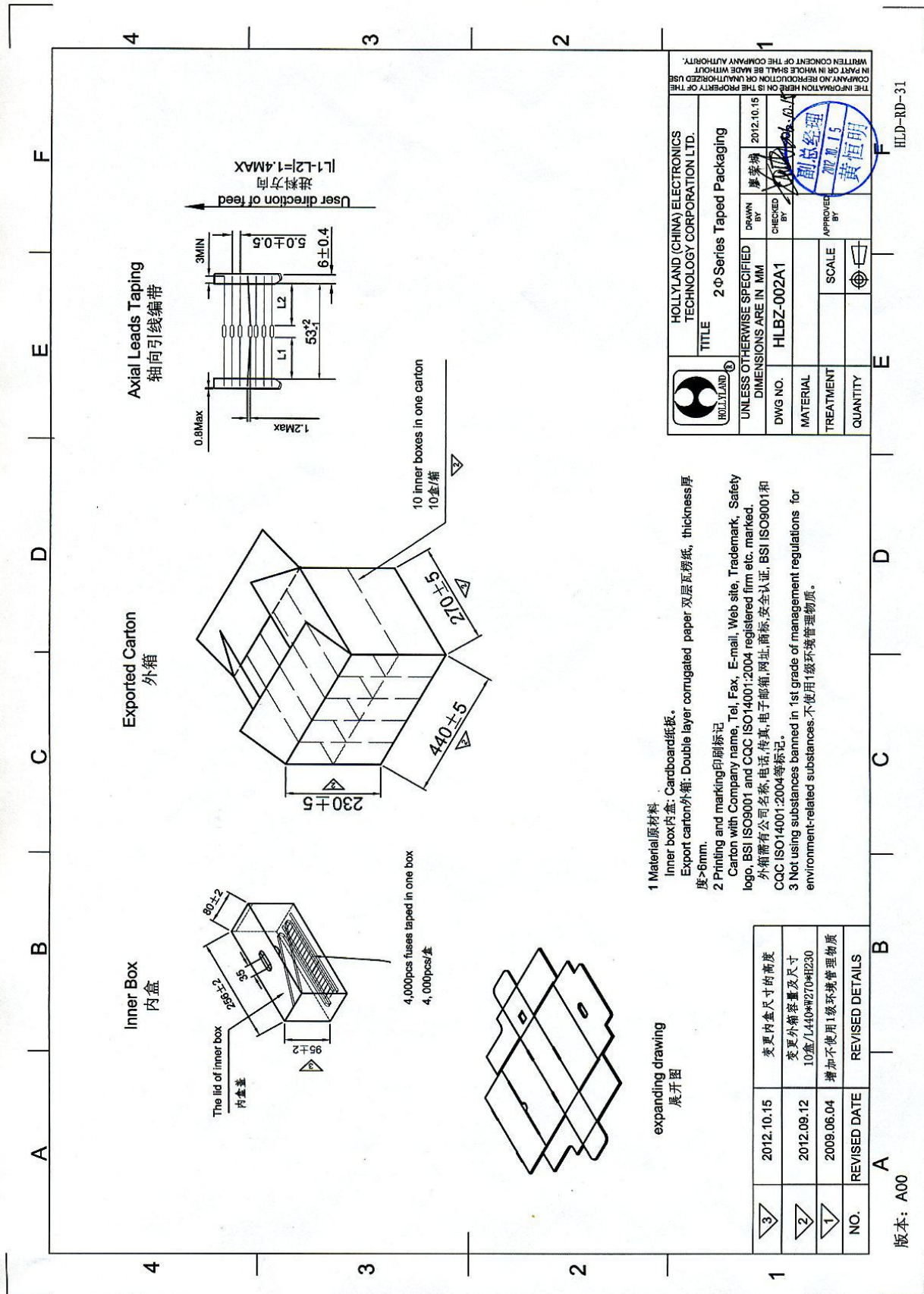

- 1 Material 原材料  
Inner box 内盒: Cardboard/纸板.  
Export carton 外箱: Double layer corrugated paper 双层瓦楞纸, thickness 厚度 > 6mm.
- 2 Printing and marking 印刷标记  
Carton with Company name, Tel, Fax, E-mail, Web site, Trademark, Safety logo, BSI ISO9001 and CQC ISO14001:2004 registered firm etc. marked.  
外箱需有公司名称, 电话, 传真, 电子邮箱, 网址, 商标, 安全认证, BSI ISO9001 和 CQC ISO14001:2004 等标记.
- 3 Not using substances banned in 1st grade of management regulations for environment-related substances. 不使用 1 级环境管理物质。

expanding drawing  
展开图

3	2012.10.15	变更内盒尺寸的高度	REVISED DATE
2	2012.09.12	变更外箱容量及尺寸 10盒/440*270*230	REVISED DETAILS
1	2009.06.04	增加不使用 1 级环境管理物质	
NO.			

		HOLLYLAND (CHINA) ELECTRONICS TECHNOLOGY CORPORATION LTD.	
TITLE 20 Series Taped Packaging		DRAWN BY 廖荣坤	2012.10.15
UNLESS OTHERWISE SPECIFIED DIMENSIONS ARE IN MM		CHECKED BY [Signature]	APPROVED BY [Signature]
DWG NO. HLBZ-002A1	MATERIAL	TREATMENT	SCALE 1:1
QUANTITY	QUANTITY	QUANTITY	QUANTITY

HLD-RD-31

版本: A00

## X-ON Electronics

Largest Supplier of Electrical and Electronic Components

*Click to view similar products for [Fuses with Leads \(Through Hole\)](#) category:*

*Click to view products by [HOLLY](#) manufacturer:*

Other Similar products are found below :

[89096-013](#) [89096-015](#) [A170100400](#) [BKPCH-5-R](#) [252010](#) [252.062](#) [SS-5-800MA-AP](#) [SS-5F-3.15A-AP](#) [252004](#) [263.750](#) [LKB-3](#) [0252001.M-0471005.MAT1L](#) [0473004.MAT1L](#) [0473.750HAT1L](#) [0471002.MAT1L](#) [0471.500MAT1L](#) [0491002.MAT1](#) [0473001.HAT1L](#) [0473002.HAT1L](#) [0473.500HAT1L](#) [SS-5-1.6A-AP](#) [SS-5F-2.5A-AP](#) [SR-5H-2.5A-AP](#) [SS-5-6.3A-BK](#) [BK-AGC-2-1-2-R](#) [BK-GMA-8-R](#) [BK-GMD-4-R](#) [BK-GMT-4A](#) [BK-MDL-1](#) [BK-PCD-5-R](#) [BK-C520-5-R](#) [BK-GMC-10-R](#) [BK-MDA-V-30-R](#) [BK-S500-500-R](#) [BK-SFE-20](#) [BK-GMA-1-25-R](#) [GMQ-3-2-10](#) [GLX-12](#) [PCB-34-R](#) [SR-5H-4A-AP](#) [RST 5-AMMO](#) [PCF-1/2-R](#) [SR-5H-3.15A-BK](#) [SR-5H-2A-BK](#) [047101.5MAT1L](#) [0471003.MAT1L](#) [GFA-12](#) [89096-005](#) [SR-5F-1-6A-BK](#)