

UNLESS OTHERWISE SPECIFIED																						
TOLERANCES ARE																						
X.X ±0.15																						
X.XX ±0.05																						
X.XXX																						
ANG.																						
±0°30'																						
UNIT																						
MM																						
DATE																						
CHK																						
REVISIONS																						
SER AREA																						
DATE																						
NUMBER																						
SCALE																						
SIZE																						
A3																						
81																						
2010.05.08																						
Joan																						
2010.05.08																						
2010.05.08																						
2010.05.08																						

深圳钜硕电子有限公司

孔位	A	B	C
4	3.75	6.25	8.55
5	5.00	7.50	9.80
6	6.25	8.75	11.05
7	7.50	10.00	12.30
8	8.75	11.25	13.55
9	10.00	12.50	14.80
10	11.25	13.75	16.05
11	12.50	15.00	17.30
12	13.75	16.25	18.55
13	15.00	17.50	19.80
14	16.25	18.75	21.05
15	17.50	20.00	22.30
16	18.75	21.25	23.55
17	20.00	22.50	24.80
18	21.25	23.75	26.05
19	22.50	25.00	27.30
20	23.75	26.25	28.55
21	25.00	27.50	29.80
22	26.25	28.75	31.05
23	27.50	30.00	32.30
24	28.75	31.25	33.55
25	30.00	32.50	34.80
26	31.25	33.75	36.05
27	32.50	35.00	37.30
28	33.75	36.25	38.55
29	35.00	37.50	39.80
30	36.25	38.75	41.05
31	37.50	40.00	42.30
32	38.75	41.25	43.55
33	40.00	42.50	44.80
34	41.25	43.75	46.05
35	42.50	45.00	47.30
36	43.75	46.25	48.55
37	45.00	47.50	49.80
38	46.25	48.75	51.05
39	47.50	50.00	52.30
40	48.75	51.25	53.55

性能：

额定电流：1A

额定电压：200V

耐压：500V

接触电阻： $\leq 20m\Omega$

绝缘电阻：500M $\Omega$

工作温度： $-20^{\circ}C \sim +85^{\circ}C$

塑料（材质）：PBT, UL94V-0

插簧（材质）：磷青铜，镀锡/镀金

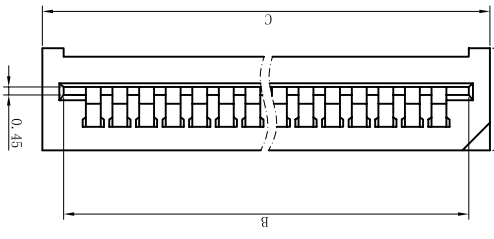
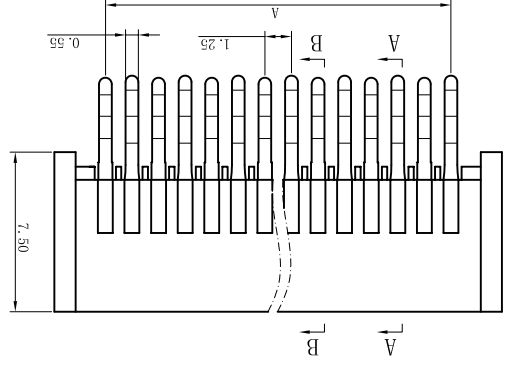
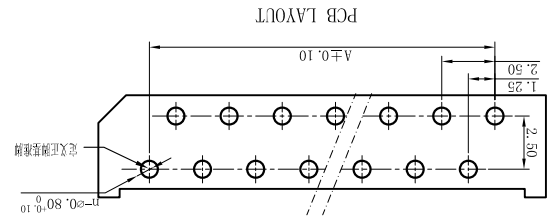
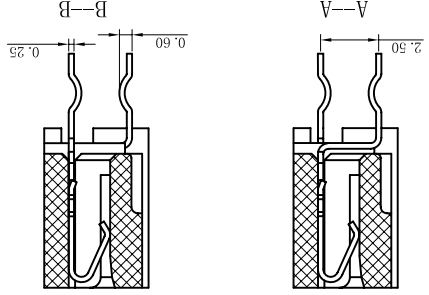
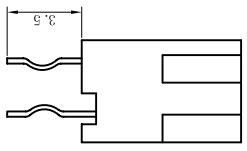
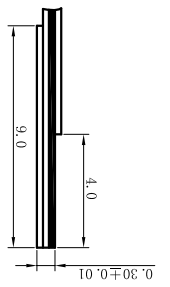
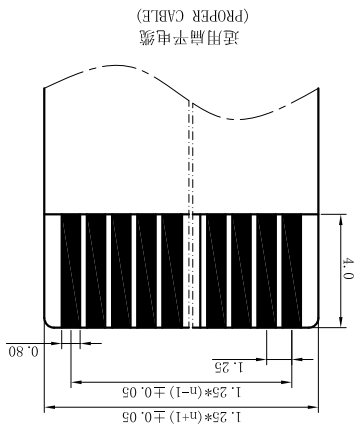

## X-ON Electronics

Largest Supplier of Electrical and Electronic Components

*Click to view similar products for [FFC & FPC Connectors](#) category:*

*Click to view products by [JUSHUO](#) manufacturer:*

Other Similar products are found below :

[HFW11R-1STE1H1LF](#) [FH29B-100S-0.2SHW\(99\)](#) [FA5S008HP1](#) [FH29B-120S-0.2SHW\(99\)](#) [FH29B-80S-0.2SHW\(99\)](#) [FHS-16](#) [FPH-2022G](#)  
[52610-1075](#) [52610-1275](#) [52610-1934](#) [XF3M\(1\)-1415-1B-R100](#) [501864-3091-TR225](#) [0525594033](#) [086210010340800](#) [086222026001800](#)  
[52271-2869-CUT-TAPE](#) [62674-201121DLF](#) [62684-36210E9ALF](#) [52610-1675](#) [52746-1671-TR250](#) [10051922-2810EHLF](#) [6-520415-9](#)  
[BD021-09A-A1-0350-0200-0550-LD](#) [SFV6R-1STE9HLF](#) [XF3M-2915-1B-R100](#) [1658549-1](#) [62674-221121ALF](#) [46214008010800](#)  
[046298003000883](#) [151660622](#) [842-816-2630-035](#) [AYF530665TA](#) [AYF351525](#) [046296011930846+](#) [AYF352325A](#) [046254020000800+](#)  
[FH19C-13S-0.5SH\(99\)](#) [FH39J-51S-0.3SHW\(99\)](#) [AYF355125A](#) [AYF530365TA](#) [FH29B-44S-0.2SHW\(99\)](#) [SFW5R-2STAE9LF](#) [AYF351125A](#)  
[AYF350725A](#) [62684-502100AHLF](#) [FH39-61S-0.3SHW\(99\)](#) [AYF414035A](#) [10064555-172520HLF](#) [AYF212335A](#) [504754-2500](#)