



Cixi Dibo Electronics Co., LTD

产品规格书
product specification

电气性能/Electrical

参考标准/Standard: UL IEC
 额定电压/Rated voltage: 30V 250V
 额定电流/Rated current: 8A 10A
 接触电阻/Contact resistance: 20m Ω
 使用线径/Wire range: 28-16AWG 1.5mm²
 耐压/Withstanding voltage: AC2000V/1Min
 绝缘电阻/Insulation resistance: 500M Ω /DC500V
 机械性能/Mechanical

温度范围/Temp.Range: -40 $^{\circ}$ C~+105 $^{\circ}$ C
 扭矩/Torque: 0.2Nm(1.71b`in)
 剥线长度/Strip length: 6-7mm

尺寸/Dimensions

间距/Pitch: 3.81mm/3.5mm
 极数/Poles: 2P-24P
 材质及电镀/Material

塑料/Housing: PA66, UL94V-0
 螺丝/Screws: M2, steel Zinc plated
 固定螺丝/Screws: M2.5, steel Zinc plated
 方块/Wire guard: Brass, Ni plated
 夹子/Clamp: Phosphor bronze, Ni plated

订购方式: HOW TO ORDER

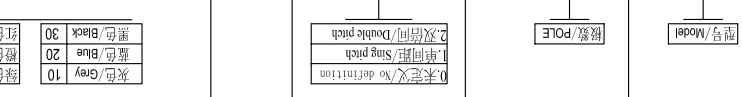

灰色/Gray	10
蓝色/Blue	20
黑色/Black	30
绿色/Green	40
黄色/Orange	50
红色/Red	60
透明/Transparent	70
灰色/Yellow	80
白色/White	90

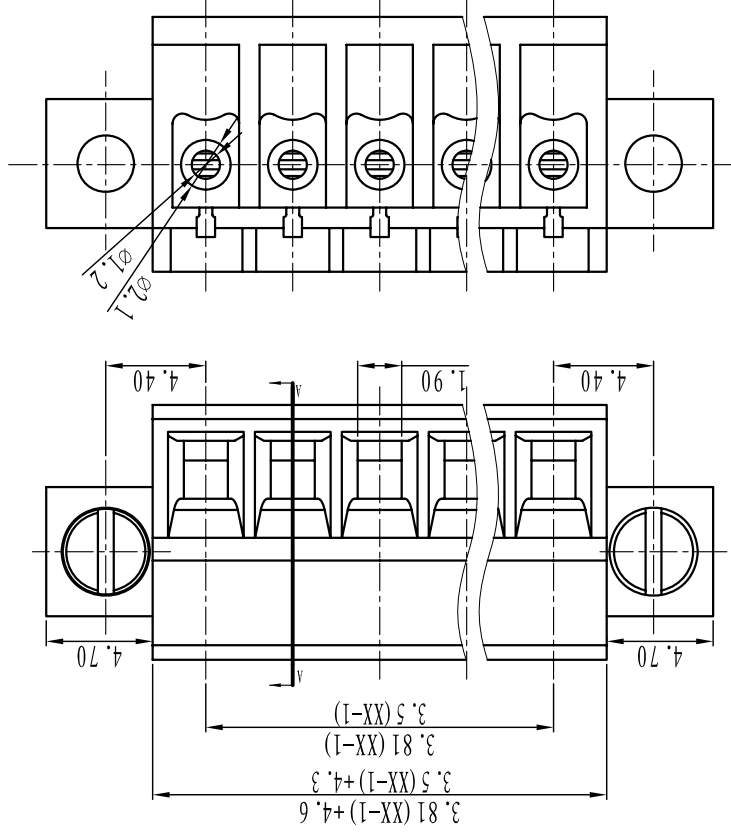
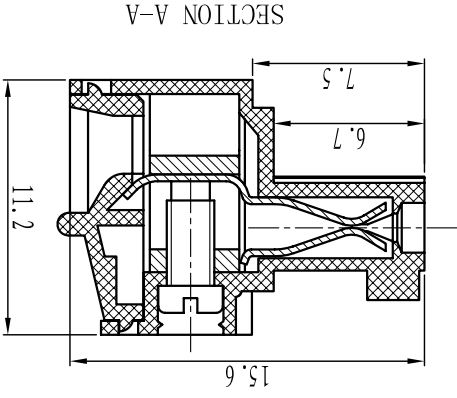

TOOLERANCES EXCEPT AS NOTED

Linear dimension	±0.1	±0.2	±0.3	±0.5	±0.9	±0.2	±0.5	±1	1 $^{\circ}$	30 $^{\circ}$	20 $^{\circ}$	10 $^{\circ}$	0.5	0.025	0.06	0.12	0.4
Variable range	to 6	to 30	to 120	to 480	to 480	all	to 6	to 10	to 10	to 50	to 120	to 120	all	to 5	to 30	to 120	to 0.4
tolerance	±0.1	±0.2	±0.3	±0.5	±0.9	±0.2	±0.5	±1	1 $^{\circ}$	30 $^{\circ}$	20 $^{\circ}$	10 $^{\circ}$	0.5	0.025	0.06	0.12	0.4

名称/NAME: Cixi Dibo Electronics Co., LTD
 单位/UNITS: mm
 尺寸/SIZE: A4
 比例/SCALE: A4
 第一视角/FIRST ANGLE PROJECTION
 DB2EKM-3.81

X-ON Electronics

Largest Supplier of Electrical and Electronic Components

Click to view similar products for [Pluggable Terminal Blocks](#) category:

Click to view products by [DIBO](#) manufacturer:

Other Similar products are found below :

[57.404.7553](#) [57.504.0053.7](#) [57.510.0053](#) [57.910.6153](#) [01.112.1453](#) [CTB932VE/6](#) [MC 1.5/ 6-ST-3.5 GY AU](#) [ET02015000J0G](#) [734-104](#) [734-302](#) [734-304](#) [8-141-P](#) [FKCT 2.5/ 3-ST KMGY](#) [860505](#) [860508](#) [860516](#) [860810](#) [861908](#) [GBPACX-12](#) [93.731.4953.0](#) [PV05-5,08-K](#) [PVP02-5,00](#) [PVP04-3,50](#) [PVS02-5,00](#) [1-1986160-3](#) [H-10](#) [1546228-5](#) [ELFH09150](#) [ELFH16150](#) [ELFP03110](#) [ELFT06250](#) [ELFT07250](#) [ELVF09400](#) [ELVP03100](#) [ELXH03100](#) [ELXH071G0E](#) [ELXP041G0](#) [ELXT046G0](#) [1700101](#) [1700410](#) [1700425](#) [1703176](#) [1703243](#) [1705229](#) [1710175](#) [1714537](#) [1717806](#) [1719600](#) [1728941](#) [1729386](#)