



产品手册

PRODUCT MANUALS



重庆金籁科技股份有限公司

Chongqing JinLai Technology Corp.,

CONTENTS

目录

公司简介	1-2
电感标示说明	3
一体成型电感 03 系	6-7
一体成型电感 04 系	8-11
一体成型电感 05 系	12-19
一体成型电感 06 系	20-30
一体成型电感 08 系	31-33
一体成型电感 10 系	34-38
一体成型电感 12 系	39-45
一体成型电感 17 系	46-48
CR 功率电感 20 系	49
CR 功率电感 25 系	50-51
CR 功率电感 30 系	52-54
CR 功率电感 40 系	55-58
CR 功率电感 50 系	59-60
CR 功率电感 60 系	61-63
CR 功率电感 80 系	64
CD 功率电感 03 系	65-66
CD 功率电感 04 系	67
CD 功率电感 05 系	68-70
CD 功率电感 07 系	71-72
CD 功率电感 10 系	73-75
贴片系列包装说明	76
DR 系列	77
DRP 系列	78
R 系列	79
T 系列	80-81
滤波器系列	82
高频变压器器系	83-87

公司简介:

金籁科技股份有限公司成立于 2003 年 8 月，总投资 8000 万人民币，旗下由惠州、重庆、两个生产工厂组成。是一家快速成长、致力于电感、变压器的生产和销售为一体的科技型企业。取得 ISO9001:2008、QC080000:2012、ISO14001:2004、IATF16949:2016 体系认证及 CQC 产品认证和 UL 安规认证。

公司长期与多家台资、港资企业合作，已全面导入无铅作业，产品畅销国内外市场。目前主要产品有：工型电感、棒型电感、环型电感、SMD 贴片电感、滤波器、交直流高频变压器、扁平线圈等系列产品。

公司自创办以来，一贯坚持“产品质量是企业唯一不能妥协的经营理念”为导向。以品牌战略为先导，以完善的工艺和对品质的孜孜追求，不断推出各种优质产品。

展望未来，公司一如既往地奉行诚恳服务、精益求精、以人为本、以客为导向的企业方针和蓬勃向上的团队精神，用人唯贤，以精湛的工艺、优质的材料，生产科技含量高、质优价廉的产品，确保让众领域的终端客户用得放心是我们的唯一宗旨。

金籁愿与您同行，携手向前，共创未来……

Jin Lai electronic technology co., LTD., founded in August 2003, a total investment of 80 million yuan, its consist of huizhou, and chongqing, two production factories. Is a fast growing, committed to the inductor, transformer production and sales for the integration of science and technology enterprises. Obtained ISO9001:2008, QC080000, ISO - 14001 system certification.

Company's long-term cooperation with many Taiwanese, hong kong-owned enterprises, has a comprehensive import lead-free, best-selling products at home and abroad market. At present main products are: engineering type inductors, bar inductance, loop inductance, SMD SMD inductor, filter, high-frequency transformer, flat coil, etc. Series of products.

Company since its inception, always adhere to the "product quality is the enterprise only will not compromise on the business philosophy of" as the guidance. With brand strategy as the guide, with perfect technology and the pursuit of quality, continuously introduce a variety of quality products.

Looking to the future, the company always pursues a sincere, pragmatic, excellence, people-oriented, to honour the enterprise policy and booming up team spirit, wei xian of choose and employ persons, with superb technology, excellent material, the production of high technology content, high quality and low price products, make sure all the areas of terminal customers use them is the only purpose we assured.

Jin Lai is willing to work with your peers, forward hand in hand, create a better future...



电感产品标识 Inductance Product Identification



产品标识 Product Identification

J*** 0503 -2R2 M T

① ② ③ ④ ⑤

① J*** 金籁料号 J Part Number

② 0503 外部尺寸 External Dimensions

③ 2R2 额定电感 Nominal Inductance

④ M 电感容量 Inductance Tolerance

J=5% K=10% L=15% M=20% P=25% N=30%

⑤ T 包装方式 Packing T 载带包装 (未标识默认) B 袋装

一体成型电感

JSHC0312 系 SPECIFICATION

外部尺寸 External Dimensions Unit:mm

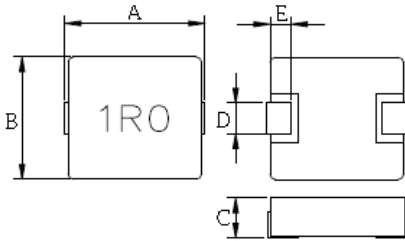

	A (Max)	B (Max)	C (Max)	D	E
JSHC0312	3.5	3.2	1.2	1.2±0.5	0.7±0.3

电气特性 Electrical Characteristics

PART NUMBER	INDUCTANCE Lo (μH) ±20% @0A	DCR (mΩ)		HEAT RATING CURRENT (Idc) DC AMPS ₁	SATURATION CURRENT (Isat) DC AMPS ₂
		Typ.	Max		
JSHC0312-R47M	0.47	23.5	28	4.0	6.0
JSHC0312-1R0M	1.0	46	55	2.8	3.6
JSHC0312-2R2M	2.2	105	125	1.8	2.8

SMD POWER INDUCTORS: JSHC0312 Series

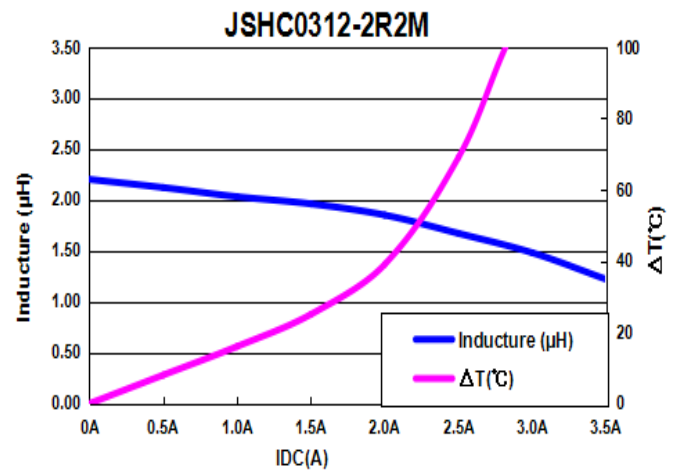
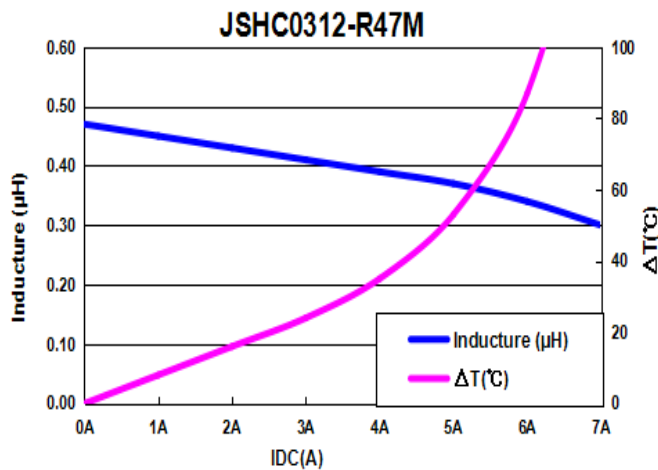

JSHC0320 系 SPECIFICATION

外部尺寸 External Dimensions Unit:mm

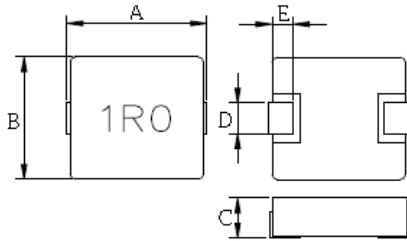

	A (Max)	B (Max)	C (Max)	D	E
JSHC0320	3.5	3.2	2.0	1.2± 0.5	0.7± 0.3

电气特性 Electrical Characteristics

PART NUMBER	INDUCTANCE Lo (μH) ±20% @0A	DCR (mΩ)		HEAT RATING CURRENT (Idc) DC AMPS ₁	SATURATION CURRENT (Isat) DC AMPS ₂
		Typ.	Max		
JSHC0320-R22M	0.22	9.5	11.4	6.5	7.5
JSHC0320-R36M	0.36	11.5	13.8	6.3	6.5
JSHC0320-R56M	0.56	16.2	19.4	5.5	5.5
JSHC0320-R68M	0.68	17	20.4	5.5	5.0
JSHC0320-R88M	0.88	18.5	22	5.5	4.5
JSHC0320-1R0M	1.0	20	24	5.0	4.5
JSHC0320-1R2M	1.2	23	27	5.0	4.0
JSHC0320-1R5M	1.5	28.5	32	3.8	4.0
JSHC0320-2R2M	2.2	42.5	46	3.0	3.3

SMD POWER INDUCTORS: JSHC0320 Series

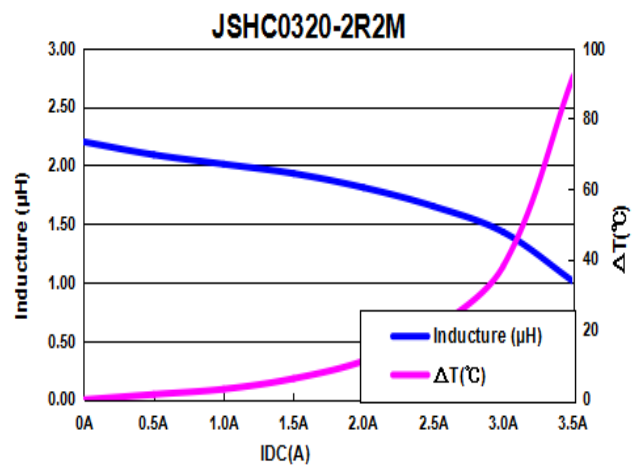
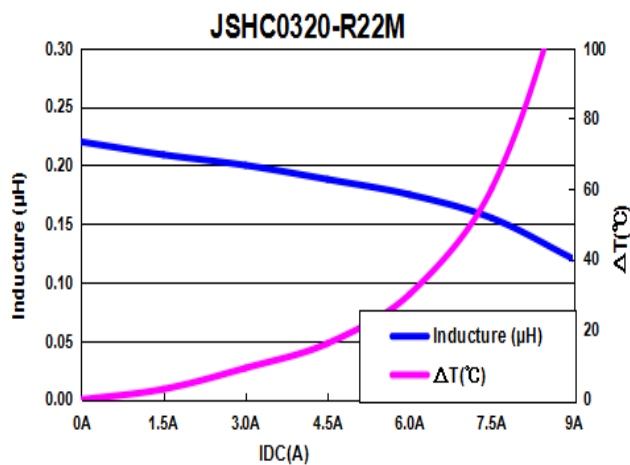

JSHC0412 系 SPECIFICATION

外部尺寸 External Dimensions Unit:mm

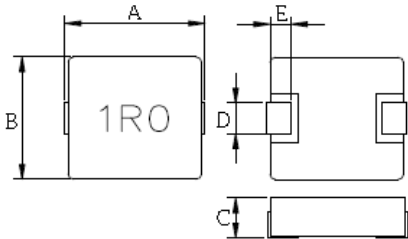

	A (Max)	B (Max)	C (Max)	D	E
JSHC0412	4.9	4.5	1.2	1.5± 0.5	1.0± 0.3

电气特性 Electrical Characteristics

PART NUMBER	INDUCTANCE Lo (μ H) ±20% @0A	DCR (m Ω)		HEAT RATING CURRENT (Idc) DC AMPS ₁	SATURATION CURRENT (Isat) DC AMPS ₂
		Typ.	Max		
JSHC0412-R22M	0.22	10.5	12	8.5	11.5
JSHC0412-R47M	0.47	22.5	25	5	7
JSHC0412-R68M	0.68	32.5	36	4.5	6
JSHC0412-1R0M	1.0	42.5	47	4.2	5.2
JSHC0412-2R2M	2.2	75.2	83.5	2.75	3.5
JSHC0412-4R7M	4.7	175.5	195	1.8	2.8

SMD POWER INDUCTORS: JSHC0412 Series

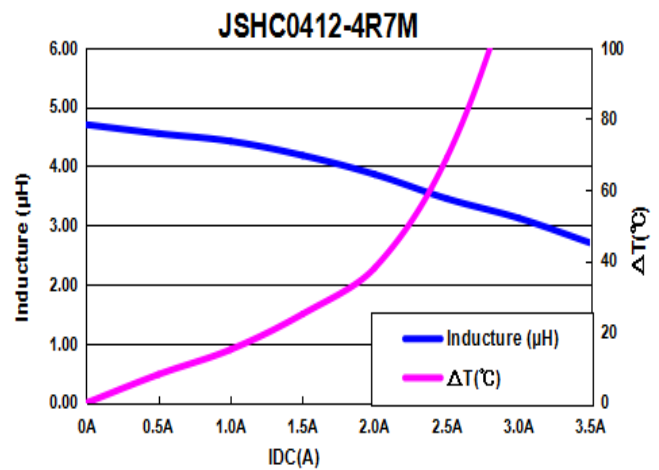
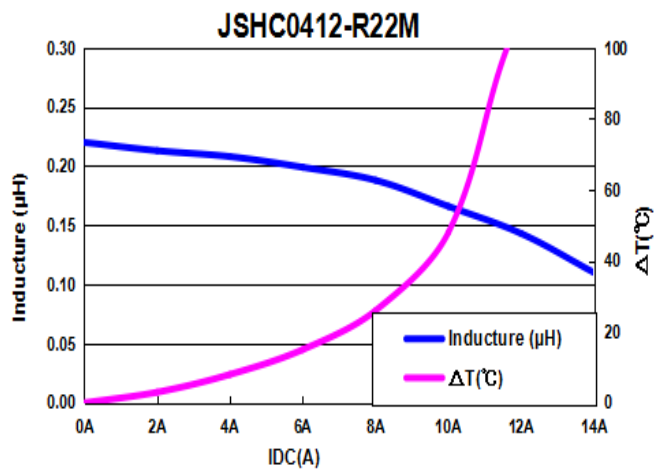

JSHC0415 系 SPECIFICATION

外部尺寸 External Dimensions Unit:mm

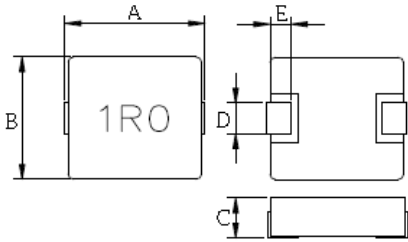

	A (Max)	B (Max)	C (Max)	D	E
JSHC0415	4.9	4.5	1.5	1.5±0.5	1.0±0.3

电气特性 Electrical Characteristics

PART NUMBER	INDUCTANCE Lo (μH) ±20% @0A	DCR (mΩ)		HEAT RATING CURRENT (Idc) DC AMPS ₁	SATURATION CURRENT (Isat) DC AMPS ₂
		Typ.	Max		
JSHC0415-R22M	0.22	7.5	9	6	9
JSHC0415-R47M	0.47	14.7	20	5	7
JSHC0415-1R0M	1.0	35	45	3.5	5
JSHC0415-1R5M	1.5	46	63	3	4
JSHC0415-2R2M	2.2	76	100	2.5	3
JSHC0415-4R7M	4.7	115	140	2	2.5

SMD POWER INDUCTORS: JSHC0415 Series

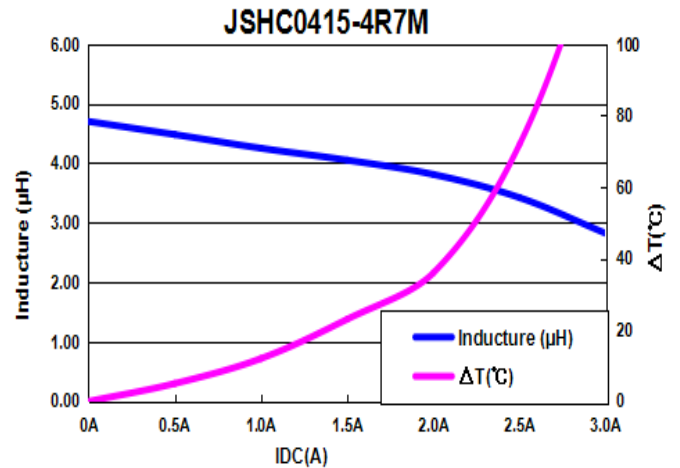
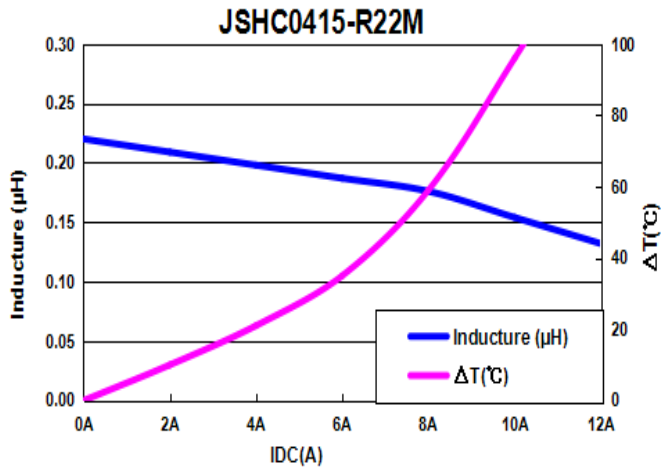

JSHC0418 系 SPECIFICATION

外部尺寸 External Dimensions Unit:mm



	A (Max)	B (Max)	C (Max)	D	E
JSHC0418	4.9	4.5	1.8	1.5± 0.5	1.0± 0.3

电气特性 Electrical Characteristics

PART NUMBER	INDUCTANCE Lo (μH) ±20% @0A	DCR (mΩ)		HEAT RATING CURRENT (Idc) DC AMPS ₁	SATURATION CURRENT (Isat) DC AMPS ₂
		Typ.	Max		
JSHC0418-1R0M	1.0	25	27	4.5	7
JSHC0418-1R5M	1.5	32	48	4	6
JSHC0418-2R2M	2.2	47	58	3	5
JSHC0418-4R7M	4.7	96	150	2	3

SMD POWER INDUCTORS: JSHC0418 Series



JSHC0420 系 SPECIFICATION

外部尺寸 External Dimensions Unit:mm



	A (Max)	B (Max)	C (Max)	D	E
JSHC0420	4.9	4.5	2.0	1.5± 0.5	1.0± 0.3

电气特性 Electrical Characteristics

PART NUMBER	INDUCTANCE Lo (μ H) ±20% @0A	DCR (mΩ)		HEAT RATING CURRENT (Idc) DC AMPS ₁	SATURATION CURRENT (Isat) DC AMPS ₂
		Typ.	Max		
JSHC0420-R22M	0.22	6.2	8	9	12
JSHC0420-R33M	0.33	8	10	8	11
JSHC0420-R36M	0.36	8.6	12	7	10
JSHC0420-R47M	0.47	10	14	6	9.5
JSHC0420-R56M	0.56	14	18	5	8
JSHC0420-R68M	0.68	14	21	5.2	8
JSHC0420-1R0M	1.0	25	27	4.5	7
JSHC0420-1R5M	1.5	32	45	4	6
JSHC0420-2R2M	2.2	47	58	3	5
JSHC0420-2R7M	2.7	47.1	58	3	4
JSHC0420-3R3M	3.3	85	90	2	3
JSHC0420-4R7M	4.7	105	150	2	2.8
JSHC0420-6R8M	6.8	130	170	2	2.5
JSHC0420-100M	10	170	200	1.5	1.8

SMD POWER INDUCTORS:

JSHC0420 Series

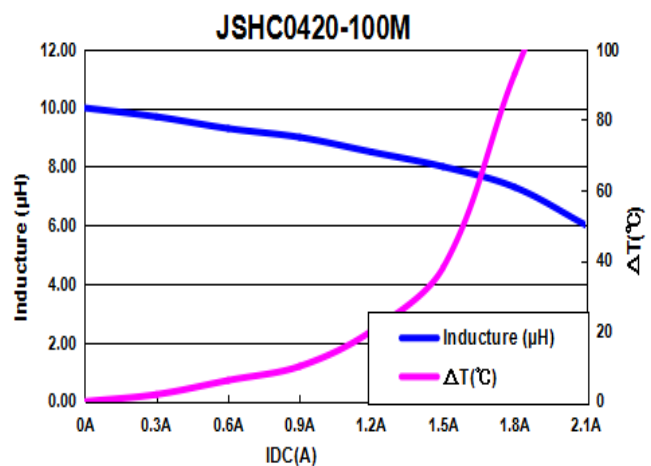
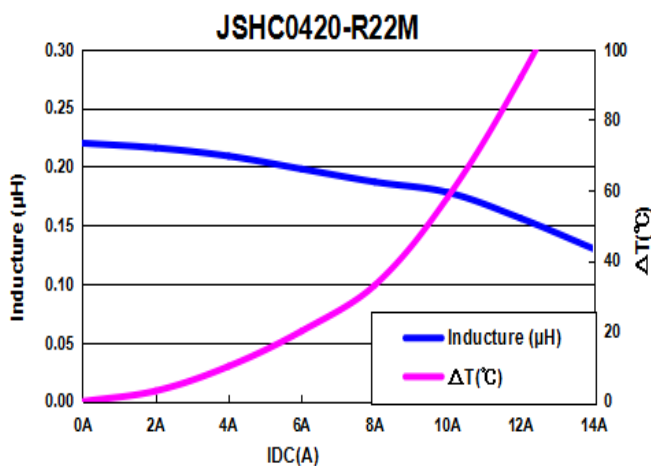

JSHC0512 系 SPECIFICATION

外部尺寸 External Dimensions Unit:mm

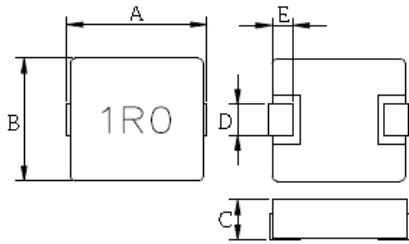

Part No.	A (Max)	B (Max)	C (Max)	D	E
JSHC0512	5.9	5.2	1.2	2.0± 0.5	1.2± 0.5

电气特性 Electrical Characteristics

PART NUMBER	INDUCTANCE Lo (μ H) ±20% @0A	DCR (mΩ)		HEAT RATING CURRENT (Idc) DC AMPS ₁	SATURATION CURRENT (Isat) DC AMPS ₂
		Typ.	Max		
JSHC0512-2R2M	2.2	68.5	76	3.5	4
JSHC0512-6R8M	6.8	225	250	2	2.3

SMD POWER INDUCTORS: JSHC0512 Series

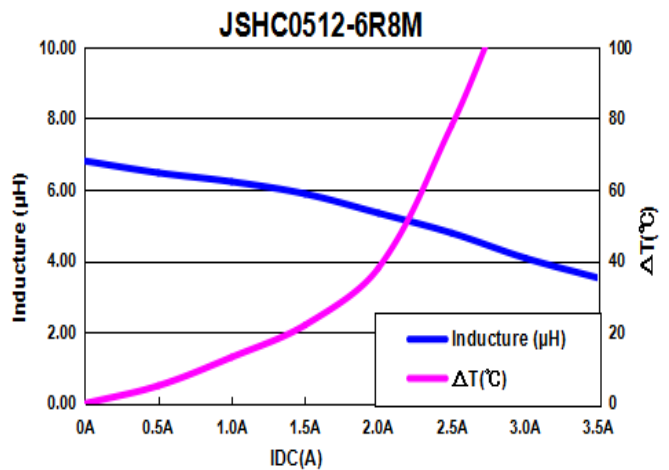

JSHC0515 系 SPECIFICATION

外部尺寸 External Dimensions Unit:mm

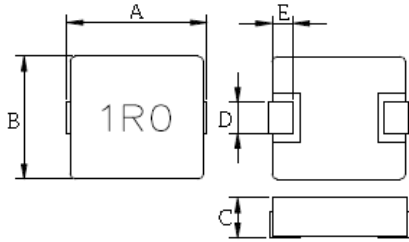

Part No.	A (Max)	B (Max)	C (Max)	D	E
JSHC0515	5.9	5.2	1.5	2.0± 0.5	1.2± 0.5

电气特性 Electrical Characteristics

PART NUMBER	INDUCTANCE Lo (μH) ±20% @0A	DCR (mΩ)		HEAT RATING CURRENT (Idc) DC AMPS ₁	SATURATION CURRENT (Isat) DC AMPS ₂
		Typ.	Max		
JSHC0515-1R0M	1.0	18	25	5	7
JSHC0515-2R2M	2.2	78	85	3	5
JSHC0515-4R7M	4.7	108	120	2.5	3

SMD POWER INDUCTORS: JSHC0515 Series

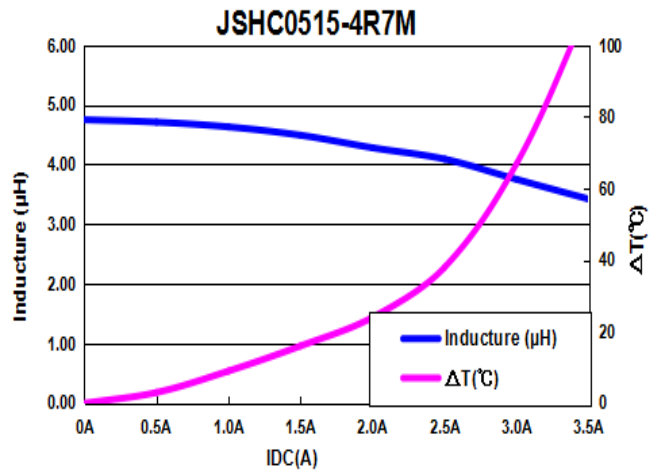
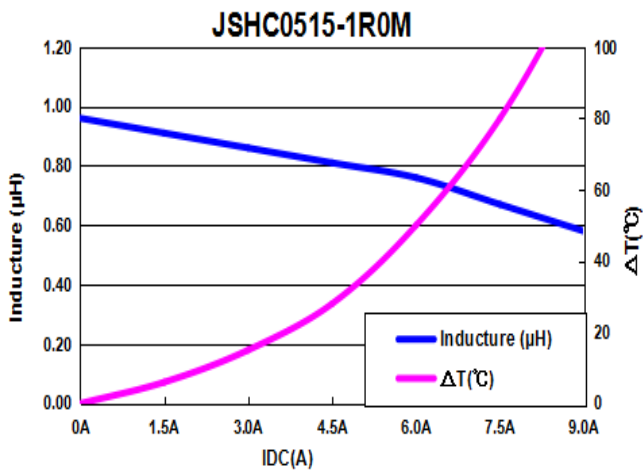

JSHC0518 系 SPECIFICATION

外部尺寸 External Dimensions Unit:mm



	A (Max)	B (Max)	C (Max)	D	E
JSHC0518	5.9	5.2	2.0	2.0± 0.5	1.0± 0.3

电气特性 Electrical Characteristics

PART NUMBER	INDUCTANCE Lo (μH) ±20% @0A	DCR (mΩ)		HEAT RATING CURRENT (Idc) DC AMPS ₁	SATURATION CURRENT (Isat) DC AMPS ₂
		Typ.	Max		
JSHC0518-R47M	0.47	8.1	9	10.5	15.5
JSHC0518-1R0M	1.0	15.3	17	8	9
JSHC0518-2R2M	2.2	31.5	35	5	6.5
JSHC0518-6R8M	6.8	108	120	2.8	3.4

SMD POWER INDUCTORS:

JSHC0518 Series

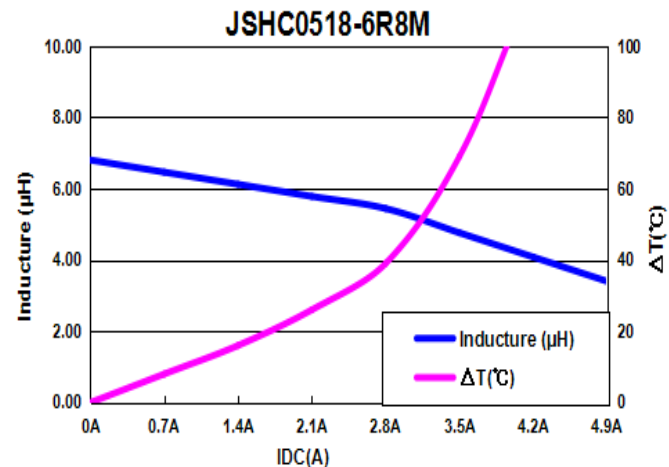

JSHC0520 系 SPECIFICATION

外部尺寸 External Dimensions Unit:mm

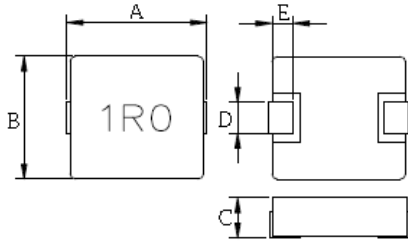

	A (Max)	B (Max)	C (Max)	D	E
JSHC0520	5.9	5.2	2.0	2.0±0.5	1.0±0.3

电气特性 Electrical Characteristics

PART NUMBER	INDUCTANCE Lo (μH) ±20% @0A	DCR (mΩ)		HEAT RATING CURRENT (Idc) DC AMPS ₁	SATURATION CURRENT (Isat) DC AMPS ₂
		Typ.	Max		
JSHC0520-R22M	0.22	4.6	6	10.5	16
JSHC0520-R33M	0.33	7.5	9	10	15
JSHC0520-R47M	0.47	8.2	10	9	12
JSHC0520-R68M	0.68	12.5	16	7	11
JSHC0520-1R0M	1.0	13	17	7	8
JSHC0520-1R5M	1.5	21	28	5	7
JSHC0520-2R2M	2.2	31	45	4	6
JSHC0520-3R3M	3.3	53	80	3.5	5
JSHC0520-4R7M	4.7	66	85	3	3.5
JSHC0520-6R8M	6.8	93	100	2	3
JSHC0520-100M	10	170	190	1.5	2.5

SMD POWER INDUCTORS:

JSHC0520 Series

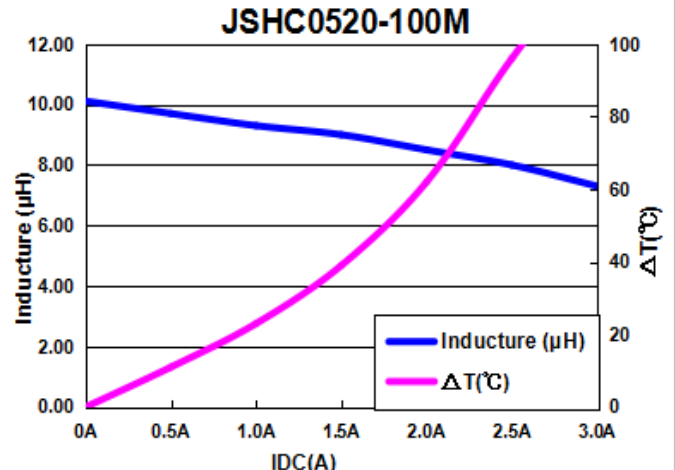
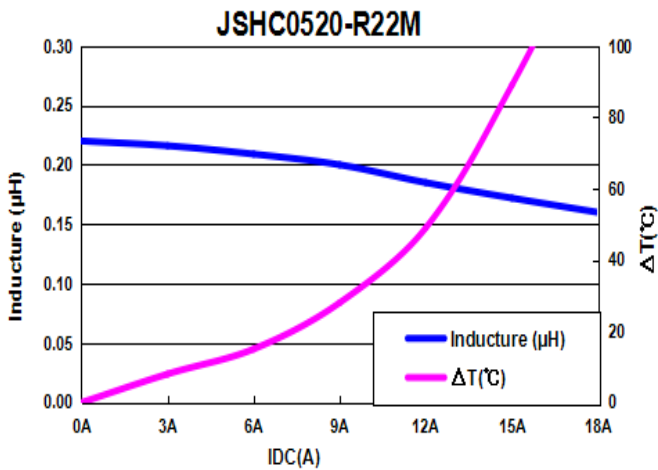

JSHC0530 系 SPECIFICATION

外部尺寸 External Dimensions Unit:mm

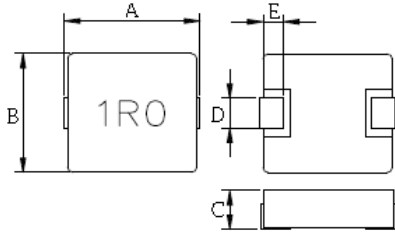

	A (Max)	B (Max)	C (Max)	D	E
JSHC0530	5.9	5.2	3.0	2.0± 0.5	1.0± 0.3

电气特性 Electrical Characteristics

PART NUMBER	INDUCTANCE Lo (μ H) ±20% @0A	DCR (mΩ)		HEAT RATING CURRENT (Idc) DC AMPS ₁	SATURATION CURRENT (Isat) DC AMPS ₂
		Typ.	Max		
JSHC0530-R47M	0.47	8	11	10	13
JSHC0530-R68M	0.68	9	12	9	12
JSHC0530-1R0M	1.0	14	16	7	11
JSHC0530-1R5M	1.5	17	22	5	10
JSHC0530-2R2M	2.2	28	35	4	9
JSHC0530-3R3M	3.3	31	38	3.5	7
JSHC0530-4R7M	4.7	42	60	3	5
JSHC0530-6R8M	6.8	77	90	2.5	3.5
JSHC0530-100M	10	82	100	2	3
JSHC0530-150M	15	146	165	1.5	2
JSHC0530-220M	22	203	230	1.2	1.5

SMD POWER INDUCTORS: JSHC0530 Series

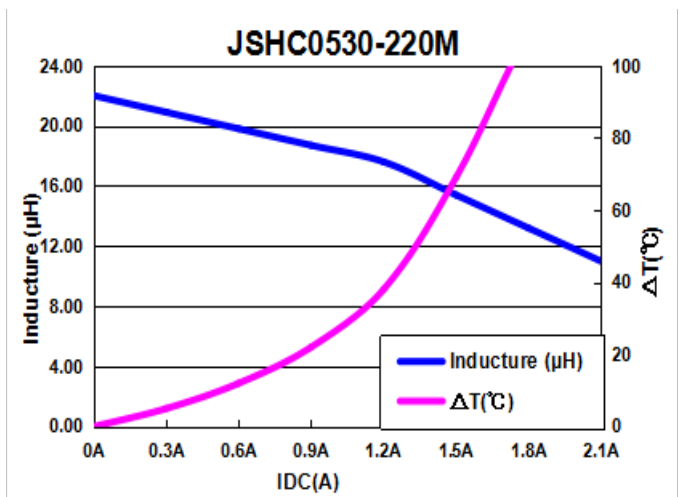
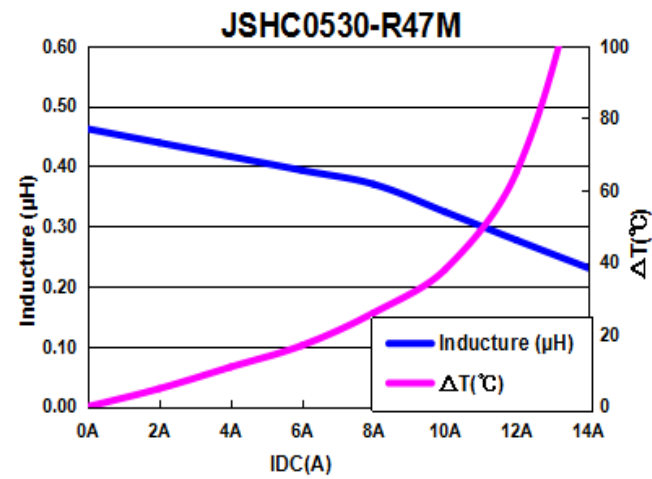

JSHC0540 系 SPECIFICATION

外部尺寸 External Dimensions Unit:mm

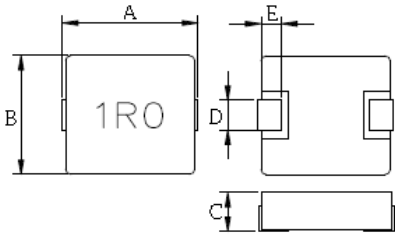

Part No.	A (Max)	B (Max)	C (Max)	D	E
JSHC0540	5.9	5.2	4.0	2.0± 0.5	1.0± 0.3

电气特性 Electrical Characteristics

PART NUMBER	INDUCTANCE Lo (μH) ±20% @0A	DCR (mΩ)		HEAT RATING CURRENT (Idc) DC AMPS ₁	SATURATION CURRENT (Isat) DC AMPS ₂
		Typ.	Max		
JSHC0540-2R2M	2.2	29	35	5.5	9
JSHC0540-100M	10	77	90	3	4

SMD POWER INDUCTORS: JSHC0540 Series

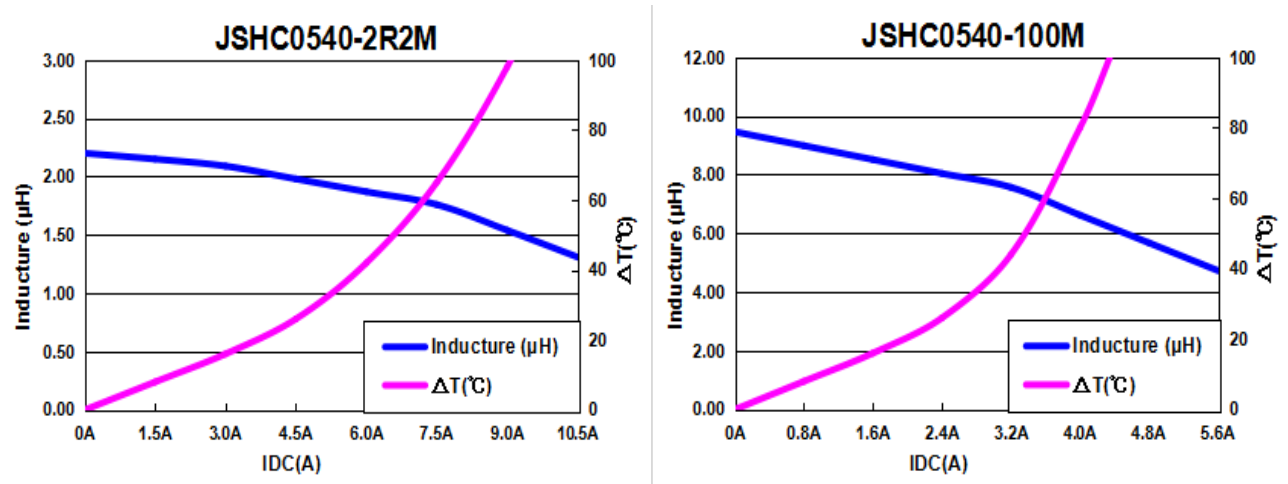

JSHC0550 系 SPECIFICATION

外部尺寸 External Dimensions Unit:mm

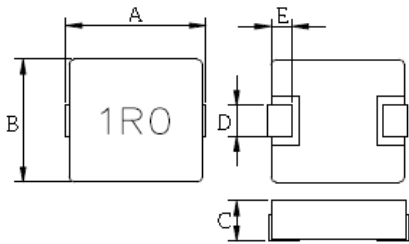

	A (Max)	B (Max)	C (Max)	D	E
JSHC0550	5.9	5.2	5.0	2.0 ± 0.5	1.0 ± 0.3

电气特性 Electrical Characteristics

PART NUMBER	INDUCTANCE Lo (μH) ±20% @0A	DCR (mΩ)		HEAT RATING CURRENT (Idc) DC AMPS ₁	SATURATION CURRENT (Isat) DC AMPS ₂
		Typ.	Max		
JSHC0550-4R7M	4.7	46	50	5	6
JSHC0550-6R8M	6.8	58	70	3	5.5
JSHC0550-150M	15	104	138	2.5	3.5
JSHC0550-220M	22	196	238	1.5	2

SMD POWER INDUCTORS:

JSHC0550 Series

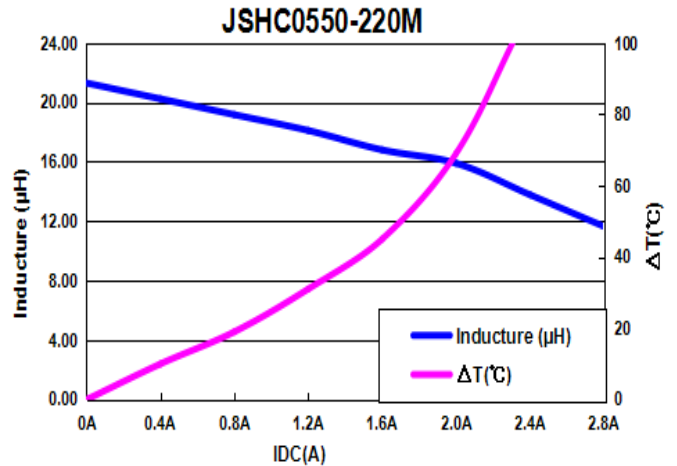
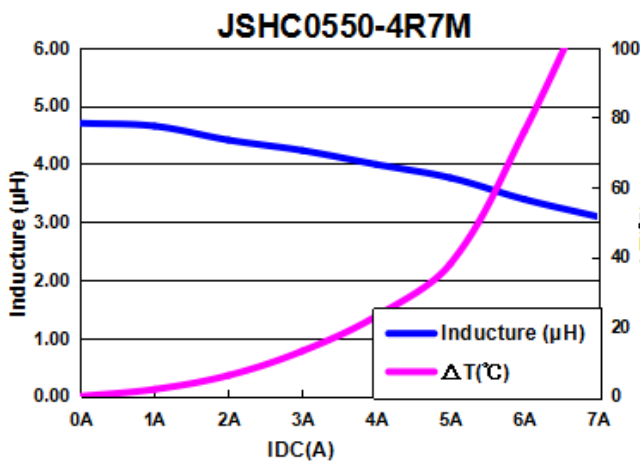

JSHC0560 系 SPECIFICATION

外部尺寸 External Dimensions Unit:mm

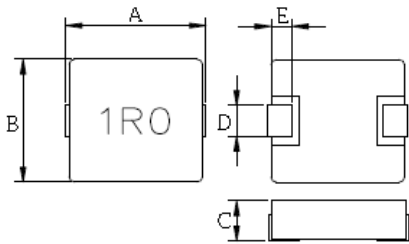

	A (Max)	B (Max)	C (Max)	D	E
JSHC0560	5.9	5.2	6.0	2.0± 0.5	1.0± 0.3

电气特性 Electrical Characteristics

PART NUMBER	INDUCTANCE Lo (μH) ±20% @0A	DCR (mΩ)		HEAT RATING CURRENT (Idc) DC AMPS ₁	SATURATION CURRENT (Isat) DC AMPS ₂
		Typ.	Max		
JSHC0560-220M	22	110	140	1.5	2.5

SMD POWER INDUCTORS: JSHC0560 Series

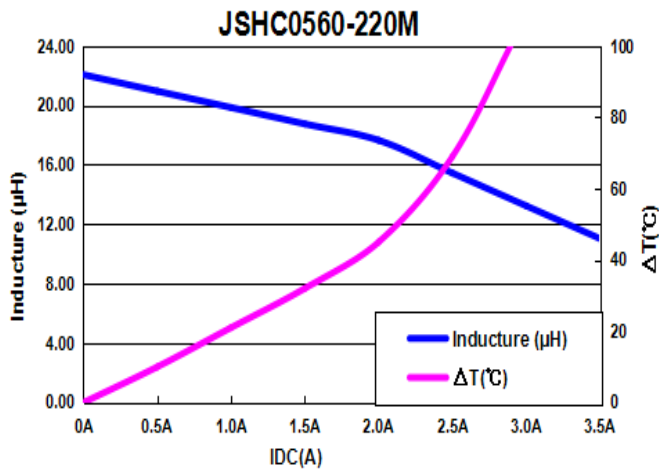

JSHC0612 系 SPECIFICATION

外部尺寸 External Dimensions Unit:mm

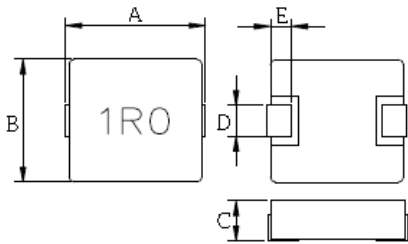

Part No.	A (Max)	B (Max)	C (Max)	D	E
JSHC0612	7.8	7.0	1.2	3.0± 0.3	1.5± 0.5

电气特性 Electrical Characteristics

PART NUMBER	INDUCTANCE Lo (μ H) ±20% @0A	DCR (mΩ)		HEAT RATING CURRENT (Idc) DC AMPS ₁	SATURATION CURRENT (Isat) DC AMPS ₂
		Typ.	Max		
JSHC0612-6R8M	6.8	18.9	210	2.2	2.8

SMD POWER INDUCTORS: JSHC0612 Series

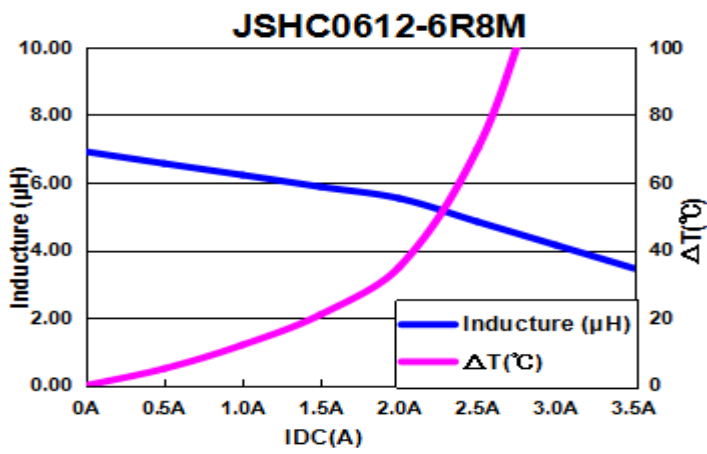

JSHC0615 系 SPECIFICATION

外部尺寸 External Dimensions Unit:mm



Part No.	A (Max)	B (Max)	C (Max)	D	E
JSHC0615	7.8	7.0	1.5	3.0±0.3	1.5±0.5

电气特性 Electrical Characteristics

PART NUMBER	INDUCTANCE Lo (μH) ±20% @0A	DCR (mΩ)		HEAT RATING CURRENT (Idc) DC AMPS ₁	SATURATION CURRENT (Isat) DC AMPS ₂
		Typ.	Max		
JSHC0615-1R0M	1.0	22.5	25	5.5	9
JSHC0615-2R2M	2.2	48.6	54	3.5	6
JSHC0615-3R3M	3.3	56.7	63	3.3	5.5
JSHC0615-4R7M	4.7	94.5	105	3.2	4.5
JSHC0615-6R8M	6.8	126	140	2.5	4

SMD POWER INDUCTORS:

JSHC0615 Series

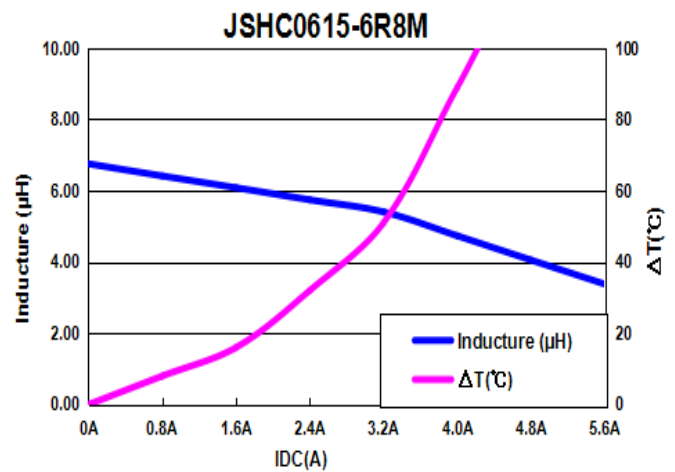
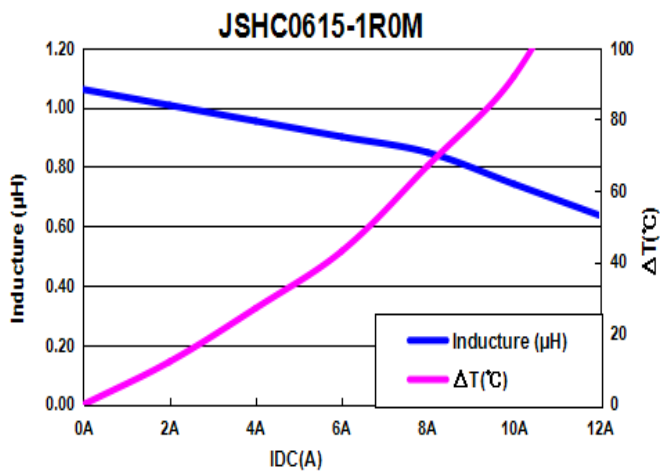

JSHC0618 系 SPECIFICATION

外部尺寸 External Dimensions Unit:mm

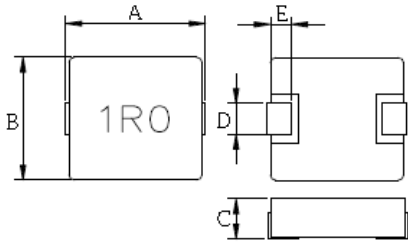

	A (Max)	B (Max)	C (Max)	D	E
JSHC0618	7.8	7.0	1.8	3.0±0.3	1.5±0.5

电气特性 Electrical Characteristic

PART NUMBER	INDUCTANCE Lo (μH) ±20% @0A	DCR (mΩ)		HEAT RATING CURRENT (Idc) DC AMPS ₁	SATURATION CURRENT (Isat) DC AMPS ₂
		Typ.	Max		
JSHC0618-R47M	0.47	7.2	8.4	11	18
JSHC0618-R68M	0.68	9.5	12	10.5	16
JSHC0618-1R0M	1.0	17	22	6	11
JSHC0618-1R5M	1.5	23	30	6.5	9.8
JSHC0618-2R2M	2.2	31	35	6	9
JSHC0618-3R3M	3.3	62	68	3.5	8
JSHC0618-4R7M	4.7	67	75	3	5
JSHC0618-100M	10.0	99	137	2	3

SMD POWER INDUCTORS:

JSHC0618 Series

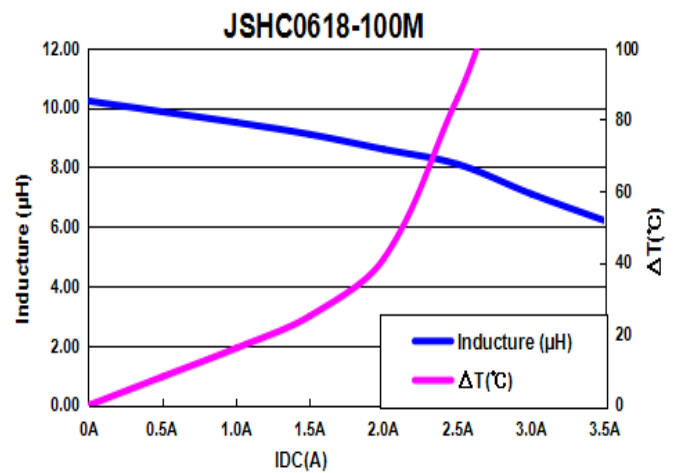
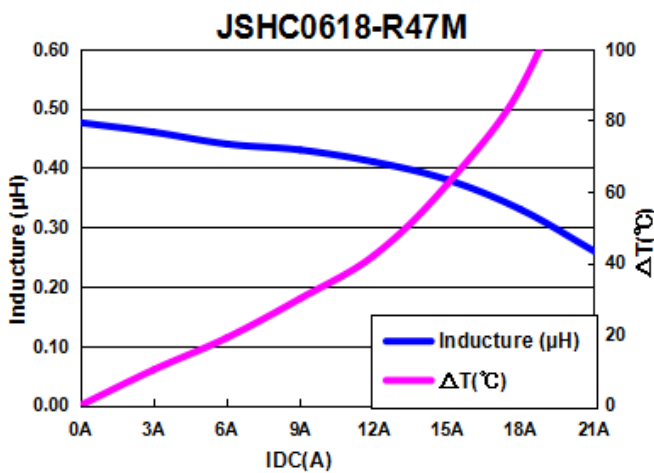

JSHC0620 系 SPECIFICATION

外部尺寸 External Dimensions Unit:mm

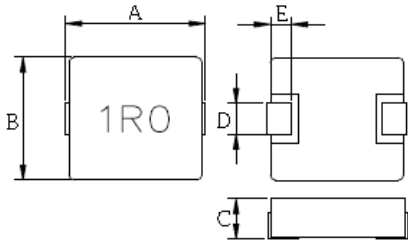

	A (Max)	B (Max)	C (Max)	D	E
JSHC0620	7.8	7.0	2.0	3.0±0.3	1.5±0.5

电气特性 Electrical Characteristic

PART NUMBER	INDUCTANCE Lo (μ H) ±20% @0A	DCR (mΩ)		HEAT RATING CURRENT (Idc) DC AMPS ₁	SATURATION CURRENT (Isat) DC AMPS ₂
		Typ.	Max		
JSHC0620-R68M	0.68	8.8	10	10.5	16
JSHC0620-1R0M	1.0	16	20	7	14
JSHC0620-1R5M	1.5	23	30	6	12
JSHC0620-2R2M	2.2	31	35	5	10
JSHC0620-3R3M	3.3	50	64	3.5	7.5
JSHC0620-4R7M	4.7	64	70	3.5	6
JSHC0620-6R8M	6.8	85	100	3	4
JSHC0620-100M	10.0	102	154	2.8	3.5

SMD POWER INDUCTORS:

JSHC0620 Series

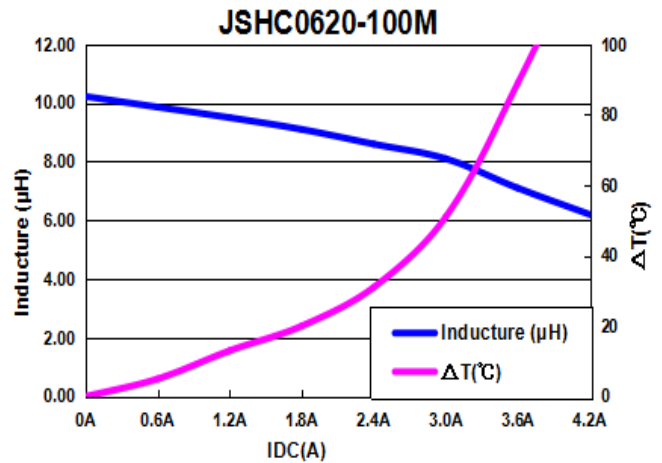
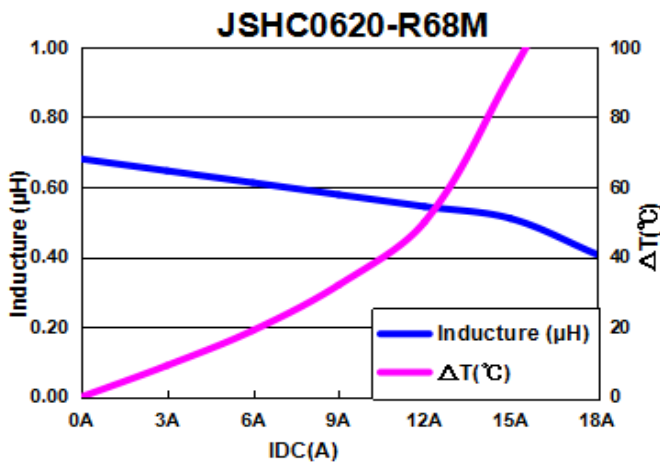

JSHC0624 系 SPECIFICATION

外部尺寸 External Dimensions Unit:mm

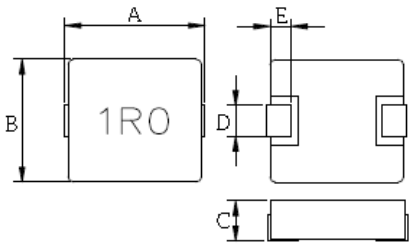

	A (Max)	B (Max)	C (Max)	D	E
JSHC0624	7.8	7.0	2.4	3.0± 0.3	1.5± 0.5

电气特性 Electrical Characteristic

PART NUMBER	INDUCTANCE Lo (μH) ±20% @0A	DCR (mΩ)		HEAT RATING CURRENT (Idc) DC AMPS ₁	SATURATION CURRENT (Isat) DC AMPS ₂
		Typ.	Max		
JSHC0624-R22M	0.22	2.2	2.8	17	35
JSHC0624-R47M	0.47	5.9	6.8	13	21
JSHC0624-R68M	0.68	6.9	8	9	20
JSHC0624-1R0M	1.0	9	11	7	13
JSHC0624-1R5M	1.5	14	20	6.5	12
JSHC0624-2R2M	2.2	22	26	6	11
JSHC0624-3R3M	3.3	23	28	5.8	8.7
JSHC0624-4R7M	4.7	59	73	3.5	8
JSHC0624-5R6M	5.6	74	80	5	7
JSHC0624-6R8M	6.8	81	90	3	5
JSHC0624-100M	10	97	125	3	4.5

SMD POWER INDUCTORS:

JSHC0624 Series

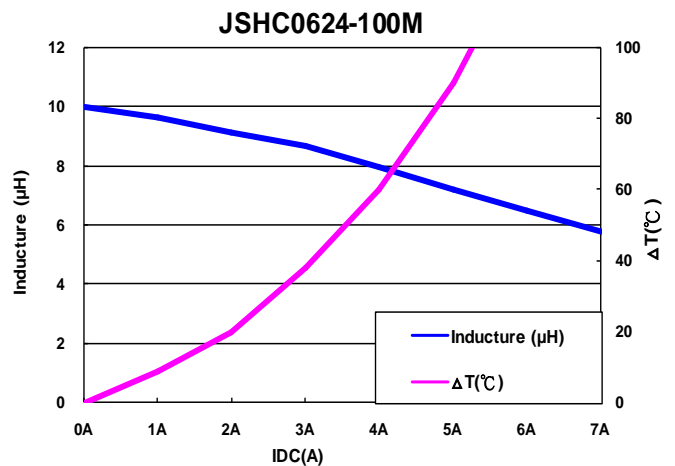
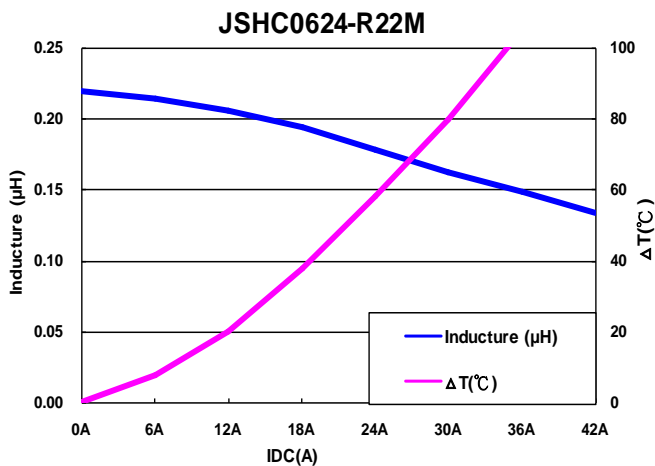

JSHC0630 系 SPECIFICATION

外部尺寸 External Dimensions Unit:mm

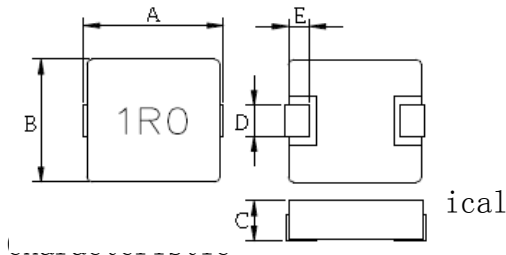

	A (Max)	B (Max)	C (Max)	D	E
JSHC0630	7.8	7.0	3.0	3.0±0.3	1.5±0.5

PART NUMBER	INDUCTANCE Lo (μH) ±20% @0A	DCR (mΩ)		HEAT RATING CURRENT (Idc) DC AMPS ₁	SATURATION CURRENT (Isat) DC AMPS ₂
		Typ.	Max		
JSHC0630-R22M	0.22	2.7	3.5	20	40
JSHC0630-R33M	0.33	3.2	3.9	20	30
JSHC0630-R47M	0.47	3.2	4.5	17.5	25
JSHC0630-R56M	0.56	4.6	5.5	15.5	24
JSHC0630-R68M	0.68	4.6	5.5	14	23
JSHC0630-R82M	0.82	6.5	8	13	20
JSHC0630-1R0M	1.0	7.5	9	11	16
JSHC0630-1R5M	1.5	11	15	9	14
JSHC0630-2R2M	2.2	15	20	8	12
JSHC0630-3R3M	3.3	28	30	6	10
JSHC0630-4R7M	4.7	38	40	5.5	9
JSHC0630-5R6M	5.6	50	60	5	7
JSHC0630-6R8M	6.8	51	60	4.5	6
JSHC0630-8R2M	8.2	75	80	4	6
JSHC0630-100M	10.0	99	105	3	5.5
JSHC0630-150M	15.0	110	140	2.8	4
JSHC0630-220M	22.0	125	167	2.5	3.5
JSHC0630-330M	33.0	245	280	1	2
JSHC0630-470M	47.0	255	290	0.8	1.8

SMD POWER INDUCTORS:

JSHC0630 Series

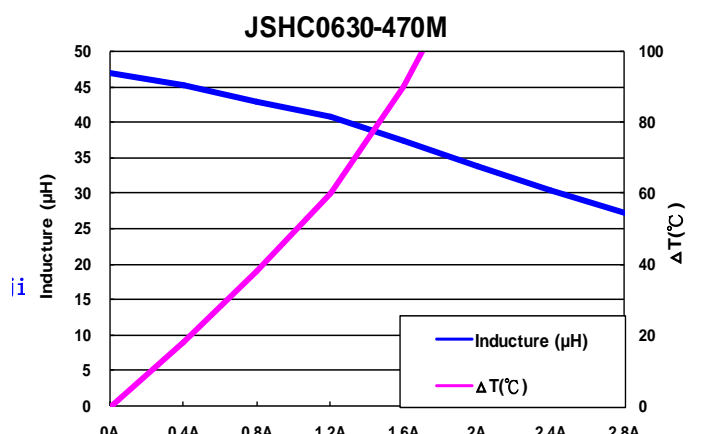
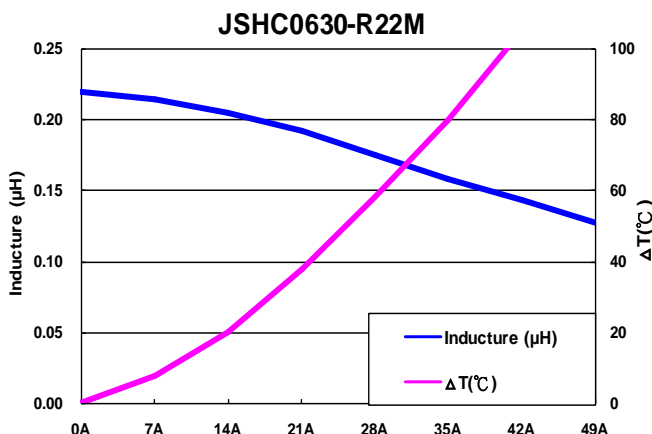

JSHC0640 系 SPECIFICATION

外部尺寸 External Dimensions Unit:mm

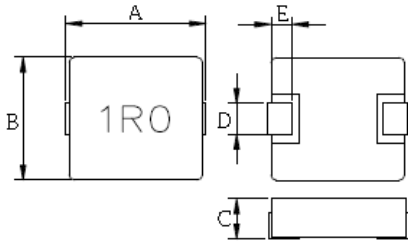

	A (Max)	B (Max)	C (Max)	D	E
JSHC0640	7.8	7.0	4.0	3.0± 0.3	1.5± 0.5

电气特性 Electrical Characteristic

PART NUMBER	INDUCTANCE Lo (μ H) ±20% @0A	DCR (mΩ)		HEAT RATING CURRENT (Idc) DC AMPS ₁	SATURATION CURRENT (Isat) DC AMPS ₂
		Typ.	Max		
JSHC0640-R56M	0.56	4.2	5.5	14	22
JSHC0640-R68M	0.68	4.2	5.5	13	20
JSHC0640-1R0M	1.0	7.4	8.5	12	19
JSHC0640-1R5M	1.5	12	15	10	16
JSHC0640-2R2M	2.2	13	18	8.5	14
JSHC0640-3R3M	3.3	17	20	7	13
JSHC0640-4R7M	4.7	23	28	6	8

SMD POWER INDUCTORS:

JSHC0640 Series

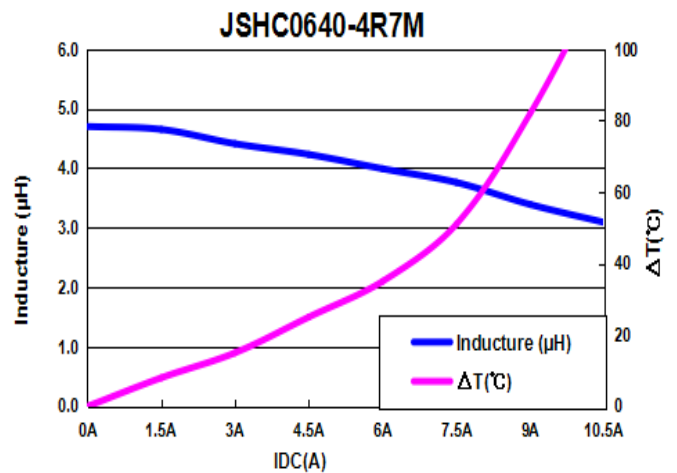
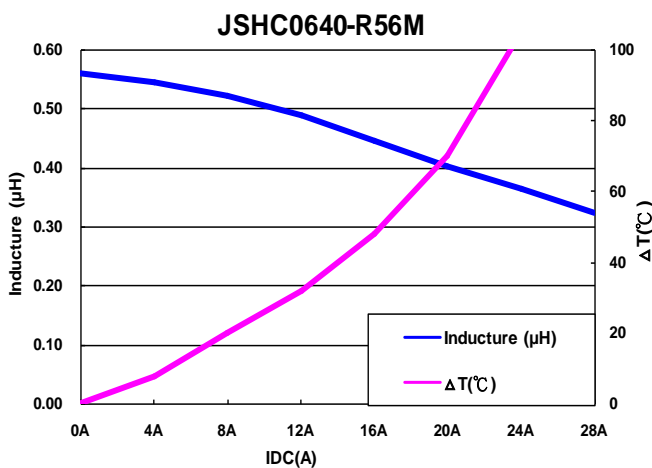

JSHC0650 系 SPECIFICATION

外部尺寸 External Dimensions Unit:mm

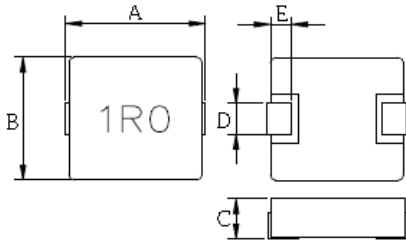

	A (Max)	B (Max)	C (Max)	D	E
JSHC0650	7.8	7.0	5.0	3.0± 0.3	1.5± 0.5

电气特性 Electrical Characteristic

PART NUMBER	INDUCTANCE Lo (μH) ±20% @0A	DCR (mΩ)		HEAT RATING CURRENT (Idc) DC AMPS ₁	SATURATION CURRENT (Isat) DC AMPS ₂
		Typ.	Max		
JSHC0650-R22M	0.22	2.3	3.5	20	45
JSHC0650-R47M	0.47	3.5	4.5	18	21
JSHC0650-R56M	0.56	4.6	6	17	25
JSHC0650-R68M	0.68	5.5	6.5	14	19
JSHC0650-R82M	0.82	6.5	7.5	14	18
JSHC0650-1R0M	1.0	7.0	8.5	13	17
JSHC0650-1R5M	1.5	7.5	9	11.5	12
JSHC0650-2R2M	2.2	10	12.5	8	12
JSHC0650-3R3M	3.3	14	20	7	9
JSHC0650-3R8M	3.8	18.6	25	6.5	8
JSHC0650-4R7M	4.7	13	15	6	7
JSHC0650-4R9M	4.9	15	16	6	6.5
JSHC0650-5R6M	5.6	25	30	6	6
JSHC0650-6R8M	6.8	26	38	5	6
JSHC0650-8R2M	8.2	36	40	4	6
JSHC0650-100M	10.0	51	60	4.5	5.3
JSHC0650-150M	15.0	65	85	3	5
JSHC0650-220M	22.0	77	85	3	4
JSHC0650-330M	33.0	184	237	2	3
JSHC0650-470M	47.0	193	280	2	2
JSHC0650-680M	68	257	310	1.3	1.8

SMD POWER INDUCTORS:

JSHC0650 Series

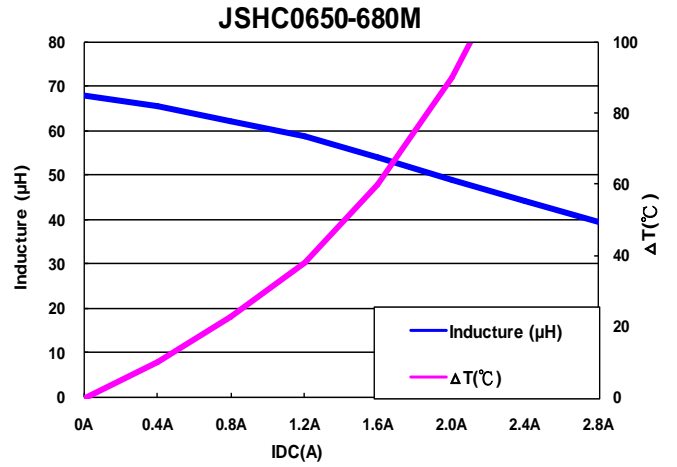
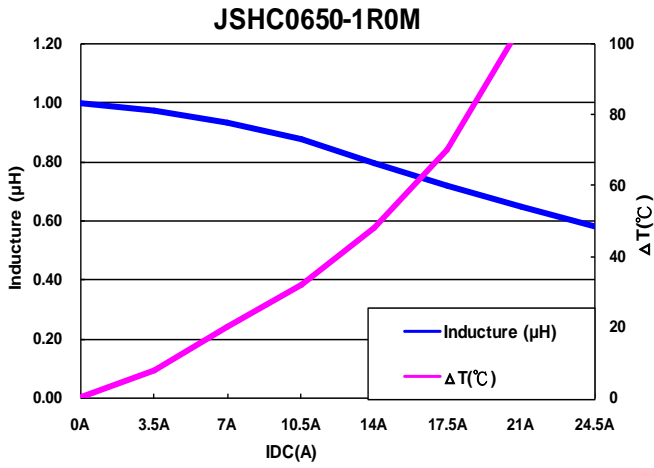

JSHC0660 系 SPECIFICATION

外部尺寸 External Dimensions Unit:mm

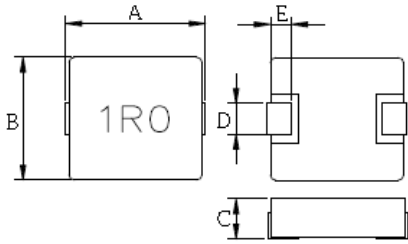

	A (Max)	B (Max)	C (Max)	D	E
JSHC0660	7.8	7.0	6.0	3.0± 0.3	1.5± 0.5

电气特性 Electrical Characteristic

PART NUMBER	INDUCTANCE Lo (μH) ±20% @0A	DCR (mΩ)		HEAT RATING CURRENT (Idc) DC AMPS ₁	SATURATION CURRENT (Isat) DC AMPS ₂
		Typ.	Max		
JSHC0660-2R2M	2.2	8	10	11	14
JSHC0660-3R3M	3.3	9	11	8	12
JSHC0660-6R8M	6.8	19	22	5	7.5

SMD POWER INDUCTORS:

JSHC0660 Series

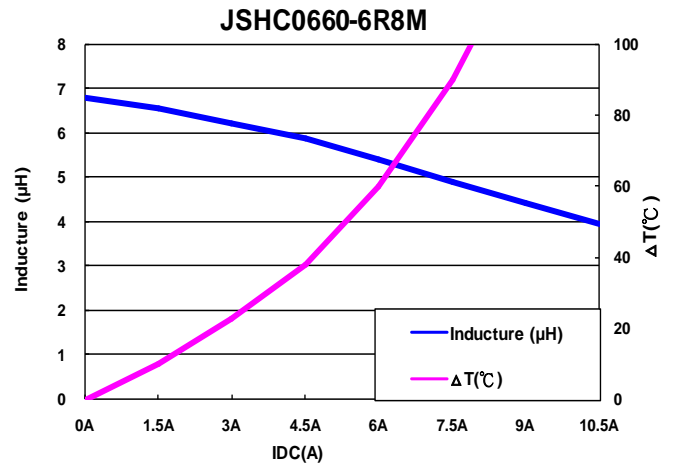
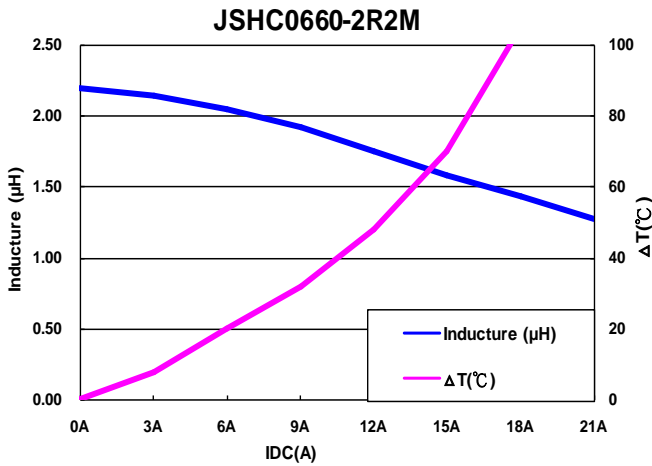

JSHC0830 系 SPECIFICATION

外部尺寸 External Dimensions Unit:mm

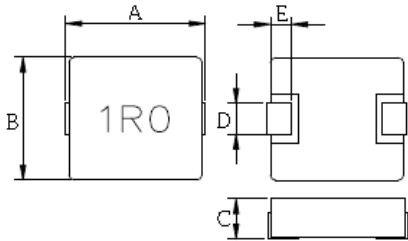

	A	B	C(Max)	D	E
JSHC0830	8.0±0.5	9.0±0.5	3.0	3.0±0.5	1.5±0.5

电气特性 Electrical Characteristic

PART NUMBER	INDUCTANCE Lo (μH) ±20% @0A	DCR (mΩ)		HEAT RATING CURRENT (Idc) DC AMPS ₁	SATURATION CURRENT (Isat) DC AMPS ₂
		Typ.	Max		
JSHC0830-2R2M	2.2	18.4	20.3	9	21
JSHC0830-3R3M	3.3	18.2	25	7	10

SMD POWER INDUCTORS:

JSHC0830 Series

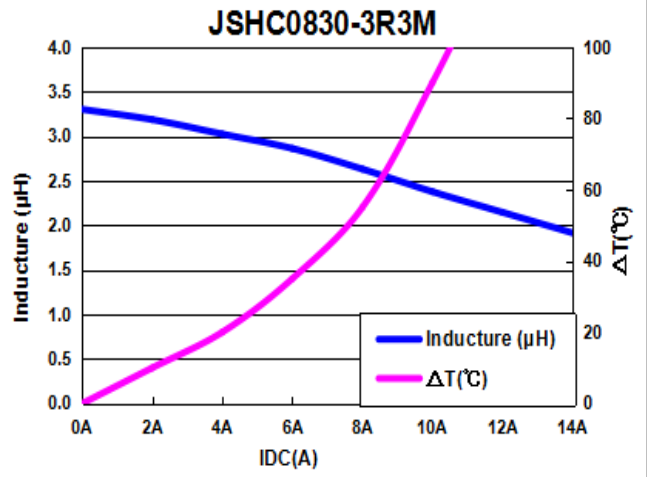
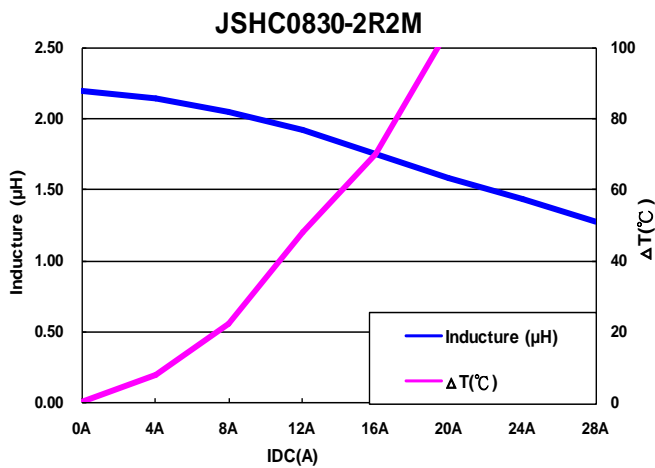

JSHC0840 系 SPECIFICATION

外部尺寸 External Dimensions Unit:mm

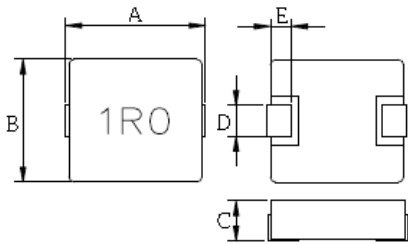

	A	B	C(Max)	D	E
JSHC0840	8.0±0.5	9.0±0.5	4.0	3.0±0.5	1.5±0.5

电气特性 Electrical Characteristic

PART NUMBER	INDUCTANCE Lo (μH) ±20% @0A	DCR (mΩ)		HEAT RATING CURRENT (Idc) DC AMPS ₁	SATURATION CURRENT (Isat) DC AMPS ₂
		Typ.	Max		
JSHC0840-R22M	0.22	1.83	2.5	16	32
JSHC0840-1R0M	1.0	7.05	8.0	10	19
JSHC0840-2R2M	2.2	10.8	12.5	8.5	15
JSHC0840-3R3M	3.3	17.8	20	8	12
JSHC0840-100M	10	36	60	4.5	5.3
JSHC0840-330M	33	138	144	2.8	3.2
JSHC0840-101M	100	372	400	1.4	2

SMD POWER INDUCTORS:

JSHC0840 Series

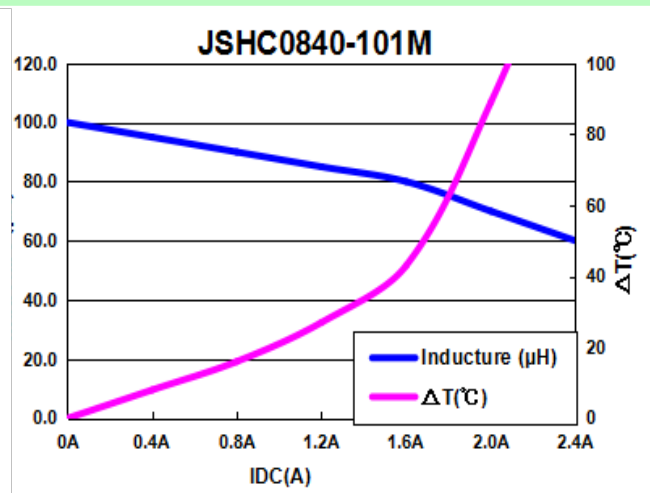
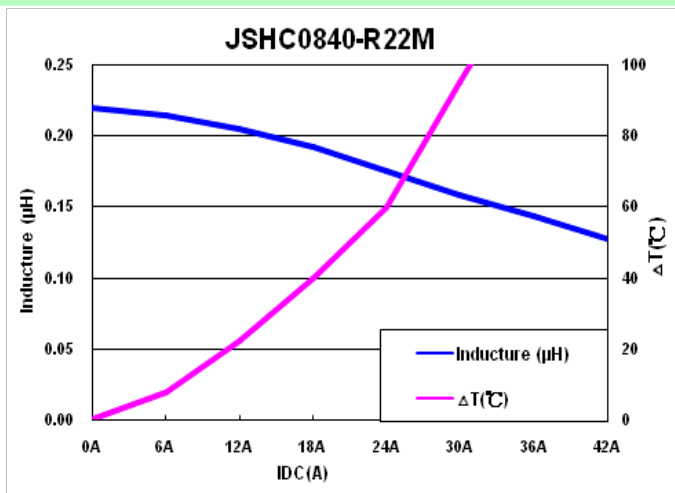

JSHC0850 系 SPECIFICATION

外部尺寸 External Dimensions Unit:mm

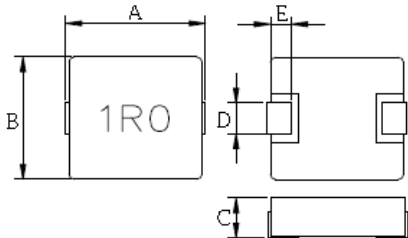

	A	B	C (Max)	D	E
JSHC0850	8.0±0.5	9.0±0.5	5.0	3.0±0.5	1.5±0.5

电气特性 Electrical Characteristic

PART NUMBER	INDUCTANCE Lo (μH) ±20% @0A	DCR (mΩ)		HEAT RATING CURRENT (Idc) DC AMPS ₁	SATURATION CURRENT (Isat) DC AMPS ₂
		Typ.	Max		
JSHC0850-R22M	0.22	0.82	0.9	32	40
JSHC0850-4R7M	4.7	14	16	6	8
JSHC0850-100M	10	31.53	40	5	7
JSHC0850-150M	15	62	75	4	6
JSHC0850-220M	22	104	120	3.5	5
JSHC0850-330M	33	117	150	3	4
JSHC0850-470M	47	184	220	2	3.2
JSHC0850-560M	56	206	235	1.8	2.8
JSHC0850-680M	68	224	280	1.6	2.5

SMD POWER INDUCTORS:

JSHC0850 Series

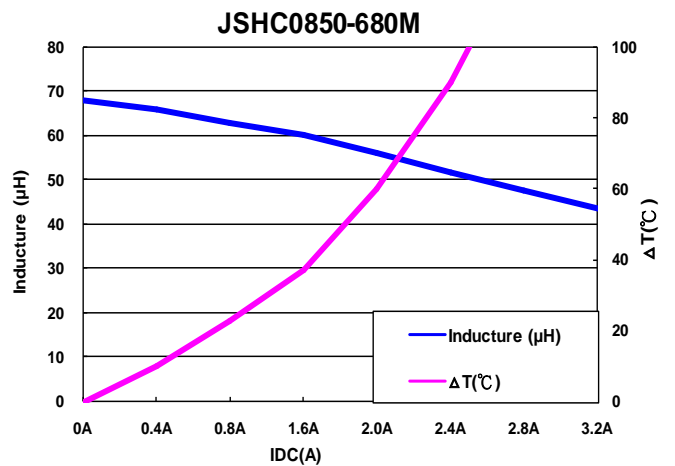
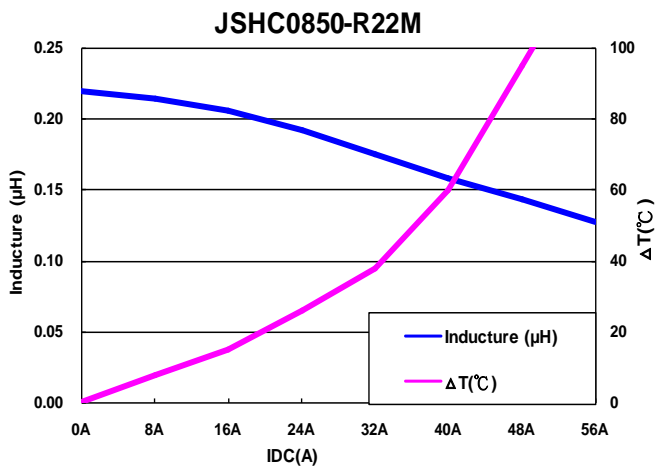

JSHC1030 系 SPECIFICATION

外部尺寸 External Dimensions Unit:mm

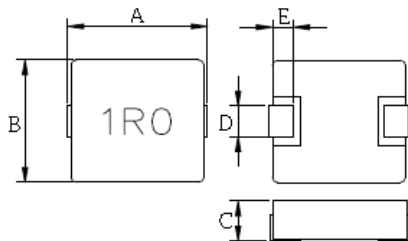

Part No.	A (Max)	B (Max)	C (Max)	D	E
JSHC1030	11.8	10.8	3.0	3.0± 0.5	2.0± 0.5

电气特性 Electrical Characteristic

PART NUMBER	INDUCTANCE Lo (μH) ±20% @0A	DCR (mΩ)		HEAT RATING CURRENT (Idc) DC AMPS ₁	SATURATION CURRENT (Isat) DC AMPS ₂
		Typ.	Max		
JSHC1030-1R0M	1.0	5.1	7.0	13	18
JSHC1030-1R5M	1.5	7.3	9	10	16
JSHC1030-2R2M	2.2	10	12	9	14
JSHC1030-4R7M	4.7	20.7	25	6	8.5
JSHC1030-8R2M	8.2	47	55	4	6
JSHC1030-100M	10	49	56	4	5
JSHC1030-150M	15	63.6	65	3.5	4

SMD POWER INDUCTORS:

JSHC1030 Series

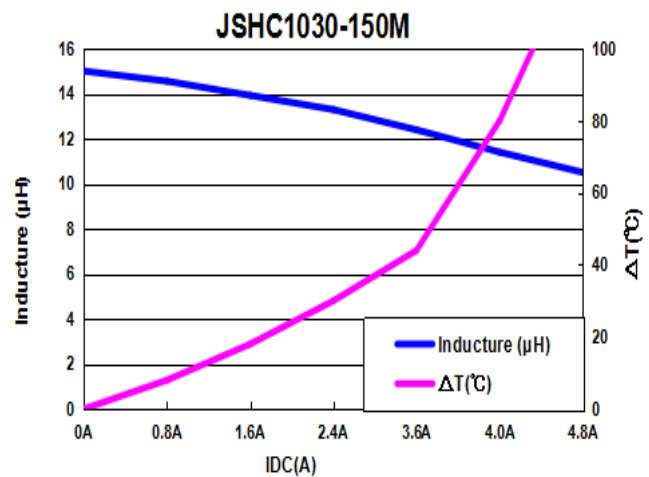
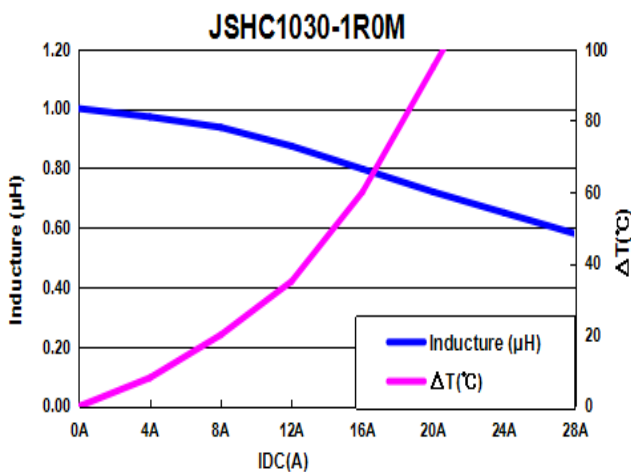

JSHC1040 系 SPECIFICATION

外部尺寸 External Dimensions Unit:mm

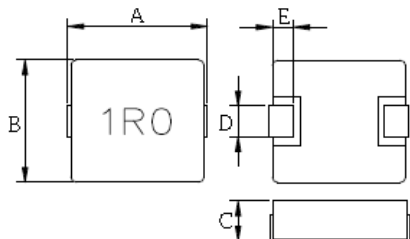

Part No.	A (Max)	B (Max)	C (Max)	D	E
JSHC1040	11.8	10.8	4.0	3.0± 0.5	2.0± 0.5

电气特性 Electrical Characteristic

PART NUMBER	INDUCTANCE Lo (μH) ±20% @0A	DCR (mΩ)		HEAT RATING CURRENT (Idc) DC AMPS ₁	SATURATION CURRENT (Isat) DC AMPS ₂
		Typ.	Max		
JSHC1040-R22M	0.22	0.7	1.1	30	60
JSHC1040-R33M	0.33	1.1	1.4	30	50
JSHC1040-R36M	0.36	1.1	1.4	30	50
JSHC1040-R47M	0.47	1.2	1.8	26	38
JSHC1040-R56M	0.56	1.5	1.8	23	33
JSHC1040-R68M	0.68	2.0	3.0	23	32
JSHC1040-R90M	0.9	2.2	3.0	21	30
JSHC1040-1R0M	1.0	3.58	4.1	18	28
JSHC1040-1R5M	1.5	4.8	5.8	16	27
JSHC1040-2R2M	2.2	7	9	12	25
JSHC1040-3R3M	3.3	10.3	13.5	10	16
JSHC1040-3R9M	3.9	13.7	16	10	16
JSHC1040-4R7M	4.7	13.7	16.5	8	14
JSHC1040-5R6M	5.6	18.2	25	8	13
JSHC1040-6R8M	6.8	23.5	28	7	12
JSHC1040-8R2M	8.2	25	30	6	9
JSHC1040-100M	10.0	31	36.5	5	9
JSHC1040-120M	12	42	48	5	8
JSHC1040-150M	15.0	42	48	4	7
JSHC1040-220M	22.0	55	60	3.5	6
JSHC1040-330M	33.0	127	145	3	4.5
JSHC1040-470M	47.0	128	145	3	3
JSHC1040-680M	68.0	205	220	2	3.5
JSHC1040-101M	100	243	270	1	2

SMD POWER INDUCTORS:

JSHC1040 Series

JSHC1040-R22M

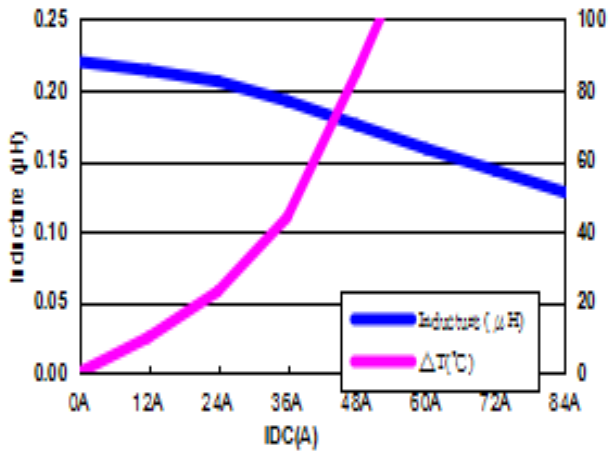

JSHC1040-101M

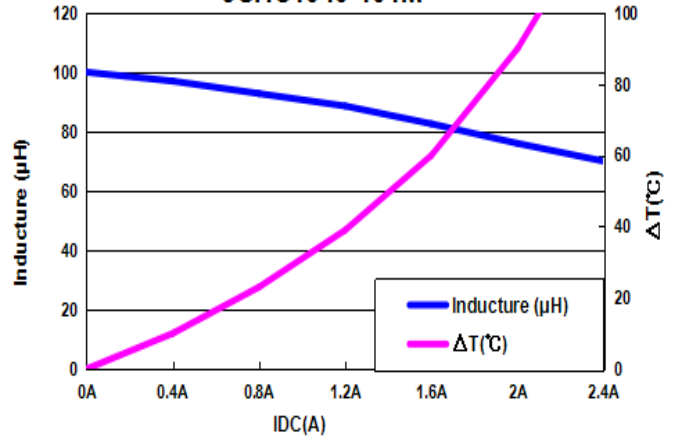

JSHC1050 系 SPECIFICATION

外部尺寸 External Dimensions Unit:mm

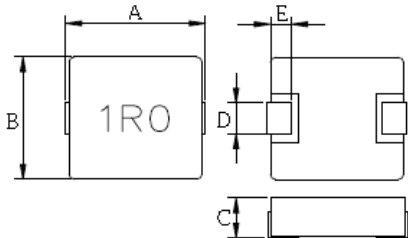

Part No.	A (Max)	B (Max)	C (Max)	D	E
JSHC1050	11.8	10.8	5.0	3.0± 0.5	2.0± 0.5

电气特性 Electrical Characteristic

PART NUMBER	INDUCTANCE Lo (μH) ±20% @0A	DCR (mΩ)		HEAT RATING CURRENT (Idc) DC AMPS ₁	SATURATION CURRENT (Isat) DC AMPS ₂
		Typ.	Max		
JSHC1050-R82M	0.82	1.8	2.5	16	32
JSHC1050-1R0M	1.0	3	4	15	30
JSHC1050-1R8M	1.8	4.5	6	15	27.5
JSHC1050-2R2M	2.2	6	8	14	27
JSHC1050-3R3M	3.3	7.5	11	10	19
JSHC1050-4R7M	4.7	14	17	9	14
JSHC1050-6R8M	6.8	17.5	22	8	10
JSHC1050-100M	10	31	38	6.8	10
JSHC1050-150M	15	39	45	6	10
JSHC1050-220M	22	52	60	5	7
JSHC1050-330M	33	127	145	3.5	6

SMD POWER INDUCTORS:

JSHC1050 Series

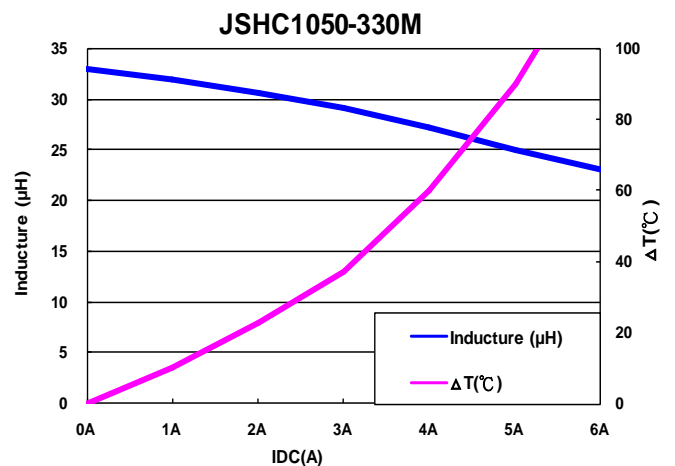
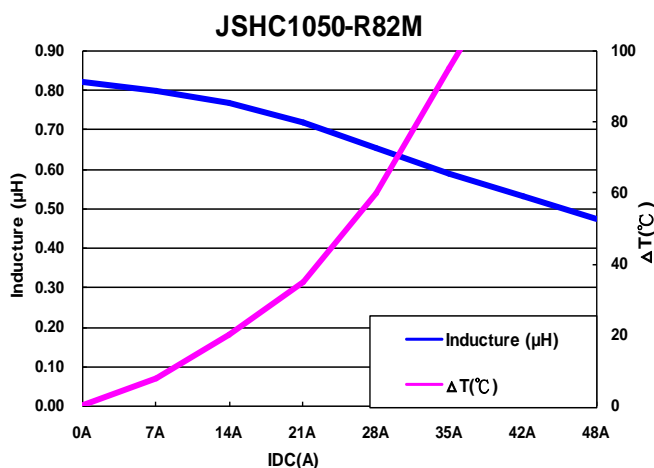

JSHC1060 系 SPECIFICATION

外部尺寸 External Dimensions Unit:mm

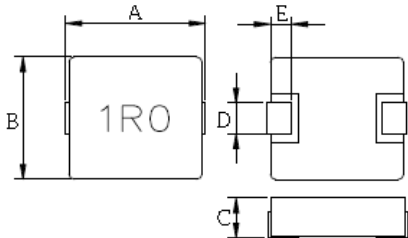

Part No.	A (Max)	B (Max)	C (Max)	D	E
JSHC1060	11.8	10.8	6.0	3.0± 0.5	2.0± 0.5

电气特性 Electrical Characteristic

PART NUMBER	INDUCTANCE Lo (μH) ±20% @0A	DCR (mΩ)		HEAT RATING CURRENT (Idc) DC AMPS ₁	SATURATION CURRENT (Isat) DC AMPS ₂
		Typ.	Max		
JSHC1060-1R0M	1.0	2.3	3	16	27
JSHC1060-1R5M	1.5	4	5	15	25
JSHC1060-2R2M	2.2	5.1	7	14	20
JSHC1060-3R3M	3.3	7	9	13	19
JSHC1060-4R7M	4.7	14	17	9	15
JSHC1060-6R8M	6.8	18	24	8	13
JSHC1060-100M	10	28	35	7	11

SMD POWER INDUCTORS:

JSHC1060 Series

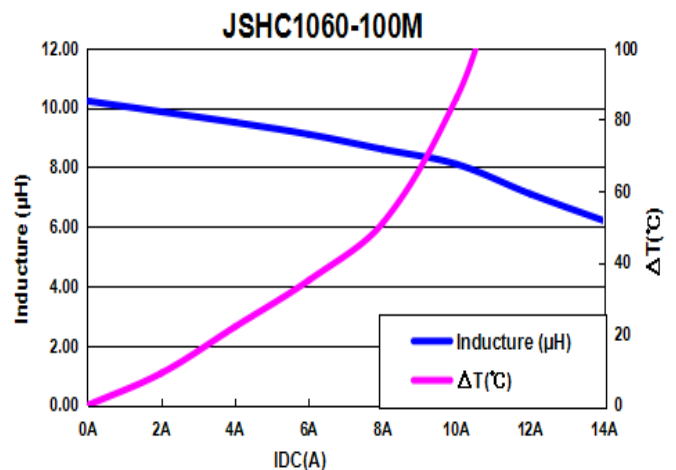
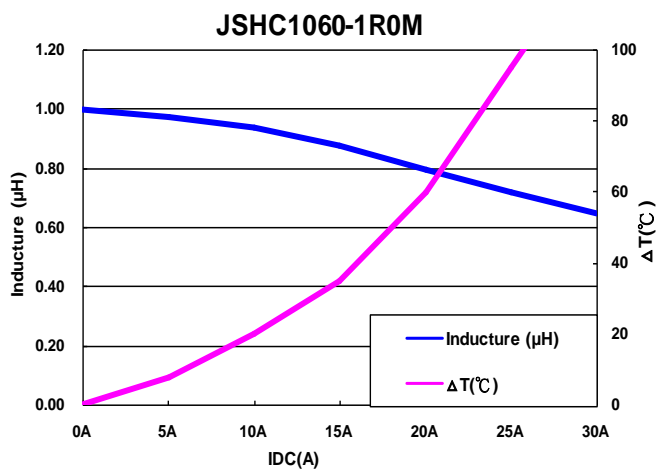

JSHC1235 系 SPECIFICATION

外部尺寸 External Dimensions Unit:mm

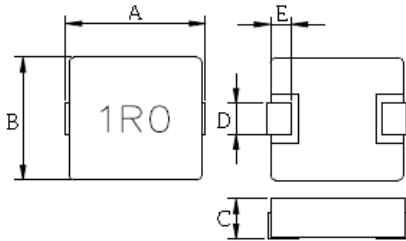

Part No.	A (Max)	B (Max)	C (Max)	D	E
JSHC1235	14.5	13.5	3.5	3.5±0.5	2.5±0.5

电气特性 Electrical Characteristic

PART NUMBER	INDUCTANCE Lo (μH) ±20% @0A	DCR (mΩ)		HEAT RATING CURRENT (Idc) DC AMPS ₁	SATURATION CURRENT (Isat) DC AMPS ₂
		Typ.	Max		
JSHC1235-R22M	0.22	0.85	1.3	25	65
JSHC1235-R68M	0.68	2.1	2.5	20	49
JSHC1235-R47M	0.47	1.17	1.7	18	35
JSHC1235-1R0M	1.0	3.3	3.5	15	26
JSHC1235-1R5M	1.5	4.3	5.0	15	24
JSHC1235-2R2M	2.2	7	8	14	20
JSHC1235-3R3M	3.3	10	12	12	16
JSHC1235-4R7M	4.7	14	15	10	14
JSHC1235-6R8M	6.8	21	25	8	12
JSHC1235-100M	10	28	35	6	10

SMD POWER INDUCTORS:

JSHC1235 Series

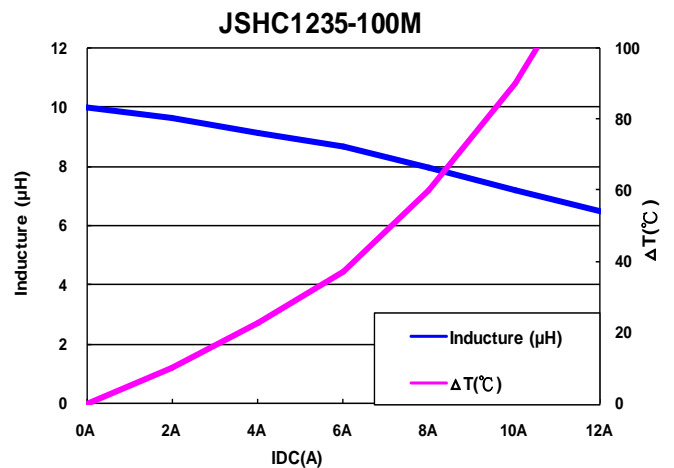
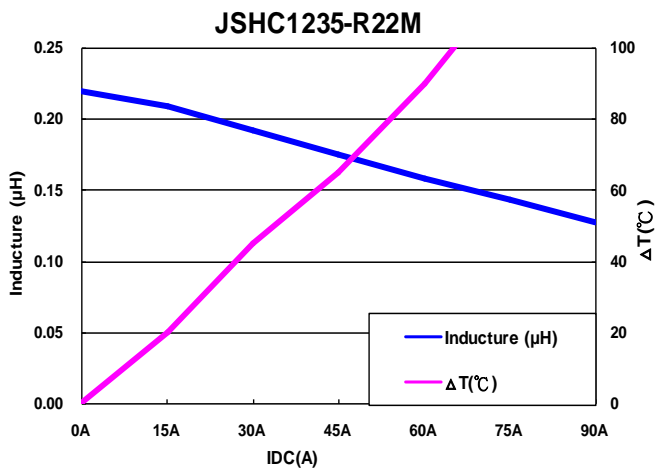

JSHC1240 系 SPECIFICATION

外部尺寸 External Dimensions Unit:mm

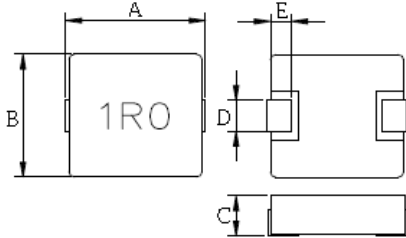

Part No.	A (Max)	B (Max)	C (Max)	D	E
JSHC1240	14.5	13.5	4.0	3.5±0.5	2.5±0.5

电气特性 Electrical Characteristic

PART NUMBER	INDUCTANCE Lo (μH) ±20% @0A	DCR (mΩ)		HEAT RATING CURRENT (Idc) DC AMPS ₁	SATURATION CURRENT (Isat) DC AMPS ₂
		Typ.	Max		
JSHC1240-R47M	0.47	1.5	2.0	23	55
JSHC1240-R60M	0.6	2	3	22	40
JSHC1240-1R0M	1.0	2.7	3.5	19	38
JSHC1240-1R5M	1.5	3.26	4.5	16	30
JSHC1240-1R8M	1.8	6.4	8.3	16	26
JSHC1240-2R2M	2.2	6.3	9.5	15	22
JSHC1240-3R3M	3.3	8.7	10	14	20
JSHC1240-4R7M	4.7	12	14	9	15
JSHC1240-5R6M	5.6	15	17	8	14
JSHC1240-6R8M	6.8	17	24	7	12
JSHC1240-8R2M	8.2	24.4	28	7	12
JSHC1240-100M	10	28	35	6	10
JSHC1240-150M	15	55.03	60	5	9
JSHC1240-220M	22	69.3	80	4	7

SMD POWER INDUCTORS: JSHC1240 Series

<http://www.cqj>

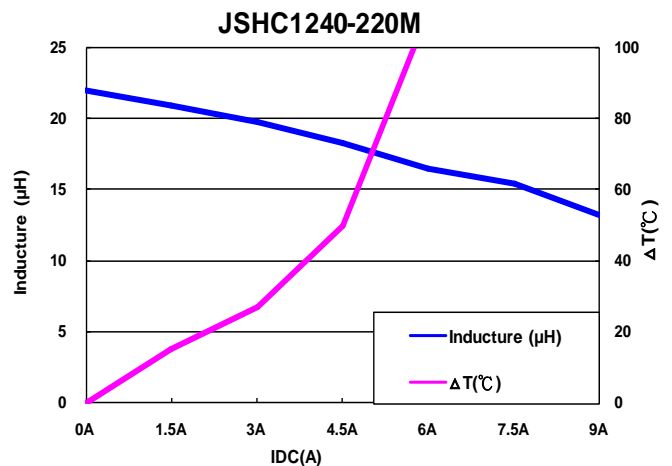

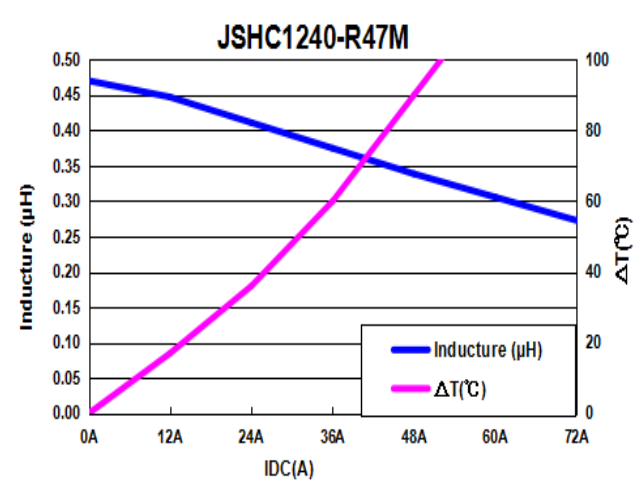

JSHC1250 系 SPECIFICATION

外部尺寸 External Dimensions Unit:mm

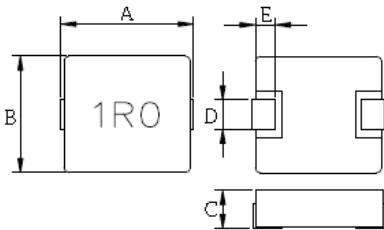

Part No.	A (Max)	B (Max)	C (Max)	D	E
JSHC1250	14.5	13.5	5.0	3.5±0.5	2.5±0.5

电气特性 Electrical Characteristic

PART NUMBER	INDUCTANCE Lo (µ H) ±20% @0A	DCR (mΩ)		HEAT RATING CURRENT (Idc) DC AMPS ₁	SATURATION CURRENT (Isat) DC AMPS ₂
		Typ.	Max		
JSHC1250-R33M	0.33	0.74	1.0	32	60
JSHC1250-R36M	0.36	0.9	1.2	28	50
JSHC1250-R47M	0.47	1.04	1.3	25	48
JSHC1250-R56M	0.56	1.35	1.5	23	46
JSHC1250-R68M	0.68	1.3	1.5	20	40
JSHC1250-R82M	0.82	2.0	2.5	19	39
JSHC1250-1R0M	1.0	2.4	3.5	18	35
JSHC1250-1R5M	1.5	2.8	4.1	18	33
JSHC1250-1R8M	1.8	3.0	4.3	17	30
JSHC1250-2R2M	2.2	3.3	4.5	16	25
JSHC1250-3R3M	3.3	10.2	13	15	23
JSHC1250-4R7M	4.7	13.5	15	12	21
JSHC1250-5R6M	5.6	14.0	17	12	20
JSHC1250-6R8M	6.8	15.4	19	11	18
JSHC1250-8R2M	8.2	18.9	22.5	10	17
JSHC1250-100M	10.0	23	25.5	6	13
JSHC1250-150M	15.0	51	60	6	12
JSHC1250-220M	22.0	63	75	4	8
JSHC1250-330M	33.0	69	82	3	6

JSHC1250-470M	47.0	78	90	2.5	3.5
JSHC1250-560M	56.0	143	180	2	3.5
JSHC1250-680M	68.0	154	210	1.5	3.5

SMD POWER INDUCTORS:

JSHC1250 Series

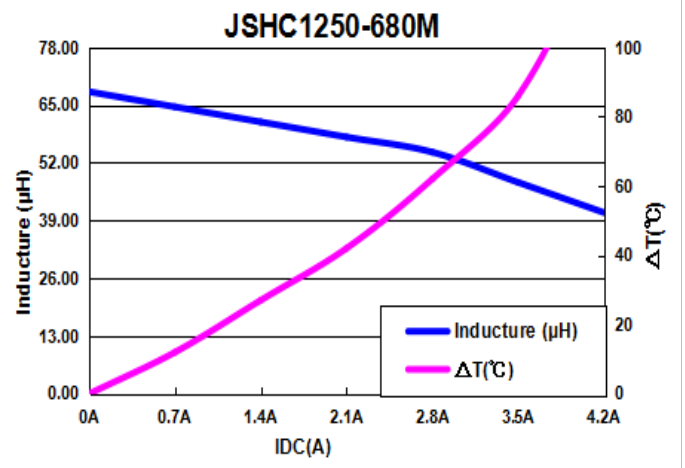
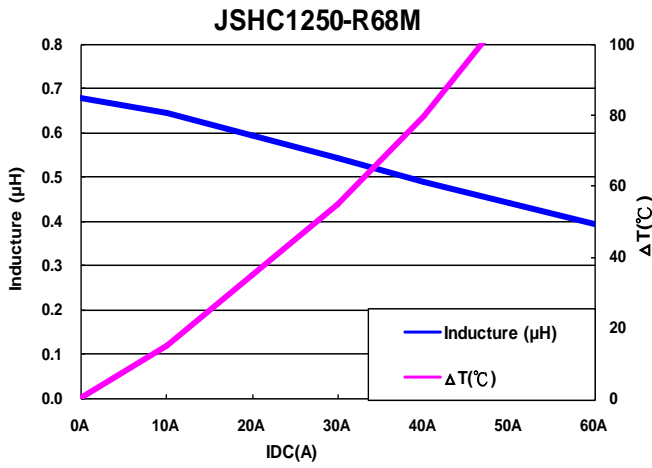

JSHC1260 系 SPECIFICATION

外部尺寸 External Dimensions Unit:mm

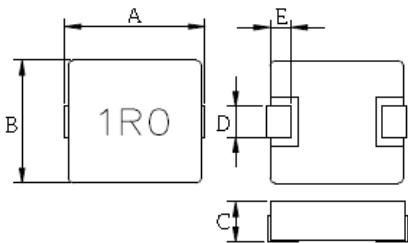

Part No.	A (Max)	B (Max)	C (Max)	D	E
JSHC1260	14.5	13.5	6.0	3.5 ± 0.5	2.5 ± 0.5

电气特性 Electrical Characteristic

PART NUMBER	INDUCTANCE Lo (μH) ±20% @0A	DCR (mΩ)		HEAT RATING CURRENT (Idc) DC AMPS ₁	SATURATION CURRENT (Isat) DC AMPS ₂
		Typ.	Max		
JSHC1260-R33M	0.33	1.3	2.3	46	55
JSHC1260-R68M	0.68	1.5	2.8	35	45
JSHC1260-1R0M	1.0	1.8	3.5	21	40
JSHC1260-1R5M	1.5	2.4	4	21	35
JSHC1260-2R2M	2.2	3.3	4.5	20	32
JSHC1260-3R3M	3.3	6.4	8.2	15	30
JSHC1260-4R7M	4.7	10	13.5	12	25
JSHC1260-5R6M	5.6	17	21	12	22
JSHC1260-6R8M	6.8	18	23	11	20
JSHC1260-100M	10	22	30	10	12.5
JSHC1260-150M	15	30	38	6	10
JSHC1260-220M	22	38	45	5	7.5

SMD POWER INDUCTORS:

JSHC1260 Series

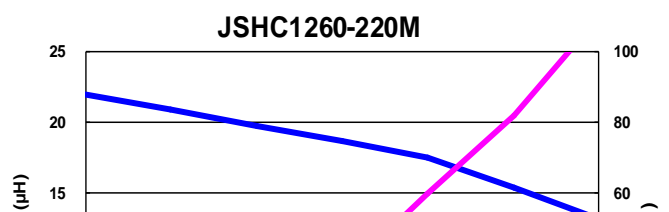
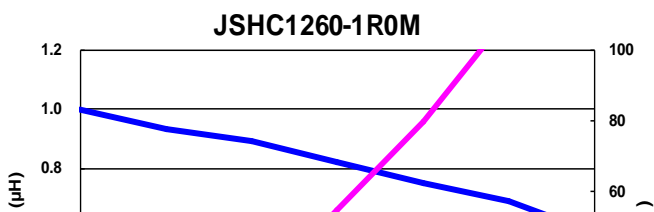

JSHC1265 系 SPECIFICATION

外部尺寸 External Dimensions Unit:mm

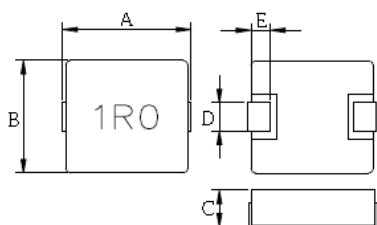

Part No.	A (Max)	B (Max)	C (Max)	D	E
JSHC1265	14.5	13.5	6.5	3.5± 0.5	2.5± 0.5

电气特性 Electrical Characteristic

PART NUMBER	INDUCTANCE Lo (μH) ±20% @0A	DCR (mΩ)		HEAT RATING CURRENT (Idc) DC AMPS ₁	SATURATION CURRENT (Isat) DC AMPS ₂
		Typ.	Max		
JSHC1265-R22M	0.22	0.60	0.81	50	80
JSHC1265-R56M	0.56	1.2	1.7	30	60
JSHC1265-R68M	0.68	1.3	1.8	28	54
JSHC1265-R82M	0.82	1.6	2.0	25	50
JSHC1265-1R0M	1.0	1.7	2.5	25	49
JSHC1265-1R5M	1.5	1.9	3.5	22	45
JSHC1265-2R2M	2.2	3.5	4.5	18	40
JSHC1265-3R3M	3.3	5.5	8.2	16	28
JSHC1265-4R7M	4.7	11	14	14	22.5
JSHC1265-5R6M	5.6	12	15	12	20
JSHC1265-6R8M	6.8	10	13	11.5	18
JSHC1265-8R2M	8.2	17	25	10	16
JSHC1265-100M	10.0	16	25	10	15.5
JSHC1265-150M	15.0	31	38	6	9
JSHC1265-220M	22.0	42	48	5	7.5
JSHC1265-330M	33.0	61	66	4	6.5
JSHC1265-470M	47.0	80	90	3.5	5

JSHC1265-560M	56.0	90	110	3	4
JSHC1265-680M	68.0	92	123	2.5	3.5
JSHC1265-121M	120.0	200	260	1.8	3
JSHC1265-151M	150.0	246	298	1.6	2.5

SMD POWER INDUCTORS:

JSHC1265 Series

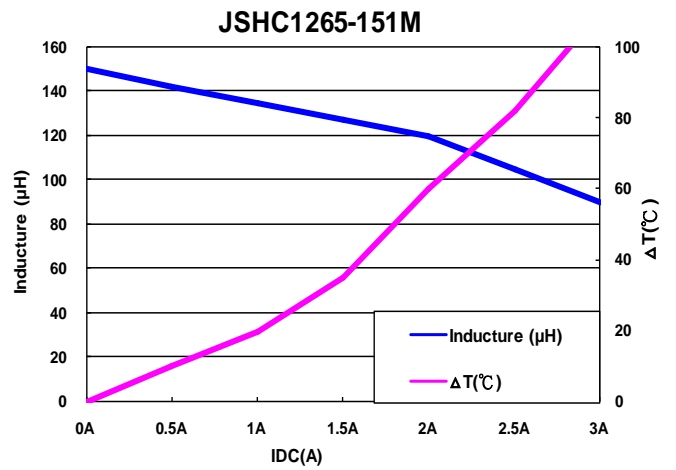
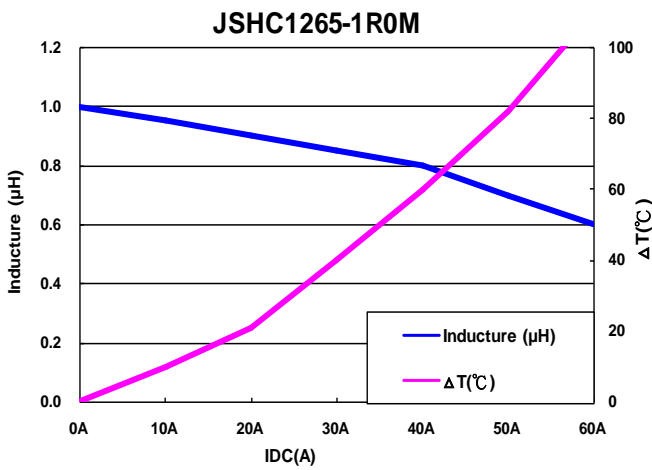

JSHC1770 系 SPECIFICATION

外部尺寸 External Dimensions Unit:mm

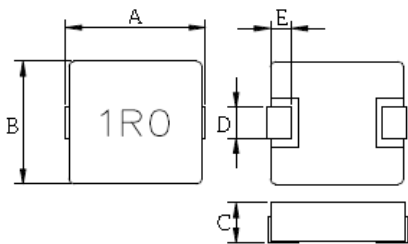

Part No.	A(Max)	B(Max)	C(Max)	D	E
JSHC1770	19.0	17.5	7.0	11.7± 0.3	3.3± 0.5

电气特性 Electrical Characteristic

PART NUMBER	INDUCTANCE Lo (μH) ±20% @0A	DCR (mΩ)		HEAT RATING CURRENT (Idc) DC AMPS1	SATURATION CURRENT (Isat) DC AMPS2
		Typ.	Max		
JSHC1770-R22M	0.22	0.55	0.70	60	100
JSHC1770-R33M	0.33	0.7	0.8	55	90
JSHC1770-R47M	0.47	0.8	1.0	50	80
JSHC1770-R56M	0.56	0.9	1.15	46	70
JSHC1770-R82M	0.82	1.17	1.3	42	60
JSHC1770-1R0M	1.0	1.45	1.7	38	50
JSHC1770-1R5M	1.5	1.8	2.15	35	45
JSHC1770-2R2M	2.2	2.15	2.6	25	34
JSHC1770-3R3M	3.3	2.61	3.5	17	24
JSHC1770-4R7M	4.7	3.38	5	15	21
JSHC1770-6R8M	6.8	5.53	7.0	15	18
JSHC1770-8R2M	8.2	7	9	12	18
JSHC1770-100M	10	8	10	11	17
JSHC1770-150M	15	12	15	9	12
JSHC1770-220M	22	19.18	25	7	9.5
JSHC1770-330M	33	30.65	35	6.5	9

JSHC1770-470M	47	36.75	40	5.5	7.5
JSHC1770-680M	68	61	80	4	5
JSHC1770-820M	82	95.55	105	4	4.5
JSHC1770-101M	100	111	120	3	4

SMD POWER INDUCTORS: JSHC1770 Series

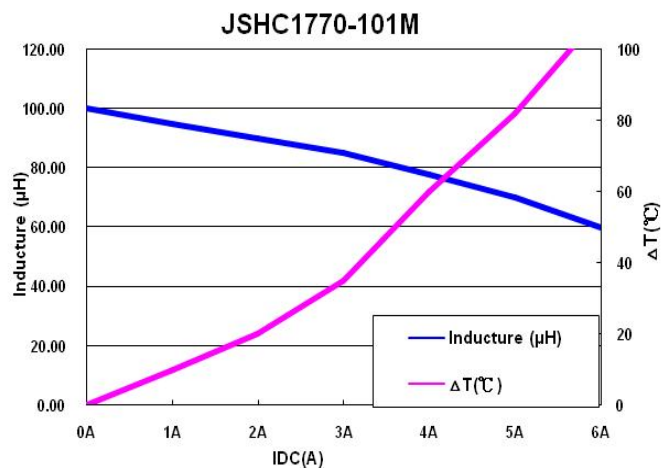
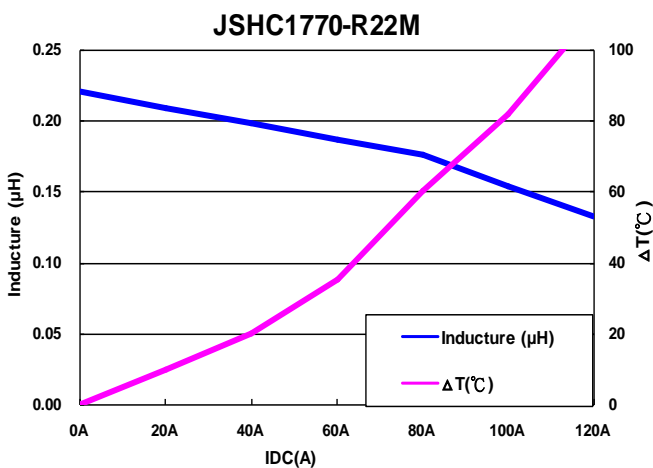

NOTES:

1. Idc : DC current (A) that will cause an approximate ΔT of 40°C
2. Isat : DC current (A) that will cause Lo to drop approximately 30%
3. All test data is referenced to 25°C ambient
4. Operating Temperature Range -40°C to +125°C
5. The part temperature (ambient + temp rise) should not exceed 125°C under the worst operating conditions. Circuit design, component placement, PWB trace size and thickness, airflow and other cooling provisions all affect the part temperature.
6. TEST FREQUENCY: 100KHz, 0.25V
7. TESTING INSTRUMENT L : Agilent4284A, WK4235, CH3302/G LCR METER
CH1320, CH1320S BIAS CURRENT SOURCE

R_{dc} :CH502BC MICRO OHMMETER

备注：以上为我司常规品特性需求，若客户有特殊需求，我司会根据客户需求进行设计。

Remark: the above requirements for our conventional product features, if customers have special requirements, we will design according to customer's requirements.

贴片功率电感

CR SMD Power Inductor

JLCR201610 系列

外部尺寸 External Dimensions Unit:mm

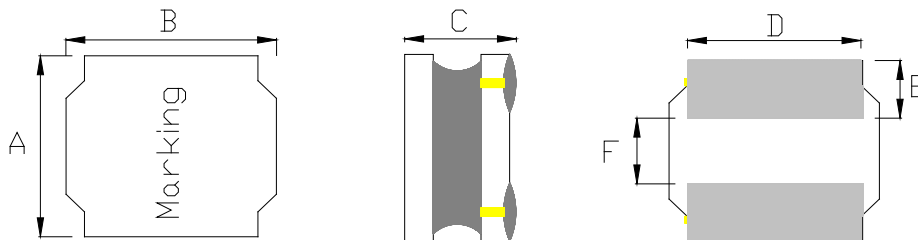

	A	B	C	D	E	F
JLCR201610	2.0±0.2	1.6±0.2	1.0Max	2.00	0.60	0.60

电气特性 Electrical Characteristics

JL Part Number	Inductance (uH)	Tolerance (±%)	DCR(mΩ) MAX	Isat (A) MAX	Irise(A) MAX	Test Condition	Marking
JLCR201610-R24MT	0.24	20	40	3.70	2.80	1MHz /1.0V	R24
JLCR201610-R33MT	0.33	20	48	3.00	2.40	1MHz /1.0V	R33
JLCR201610-R47MT	0.47	20	60	2.30	2.30	1MHz /1.0V	R47
JLCR201610-R68MT	0.68	20	76	1.95	2.00	1MHz /1.0V	R68
JLCR201610-1R0MT	1.0	20	114	1.65	1.45	1MHz /1.0V	1R0
JLCR201610-2R2MT	2.2	20	265	1.20	1.05	1MHz /1.0V	2R2

JLCR201610-4R7MT	4.7	20	480	0.75	0.70	1MHz /1.0V	4R7
JLCR201610-100MT	10.0	20	1000	0.65	0.50	1MHz /1.0V	100

1. Isat: DC current at which the inductance drops approximate 30% from its value without current;
2. Irms: DC current that causes the temperature rise ($\Delta T = 40^{\circ} C$) from $25^{\circ} C$ ambient.
3. Operating Temperature : $-40^{\circ} C \sim +105^{\circ} C$

JLCR252010 系列

外部尺寸 External Dimensions Unit:mm

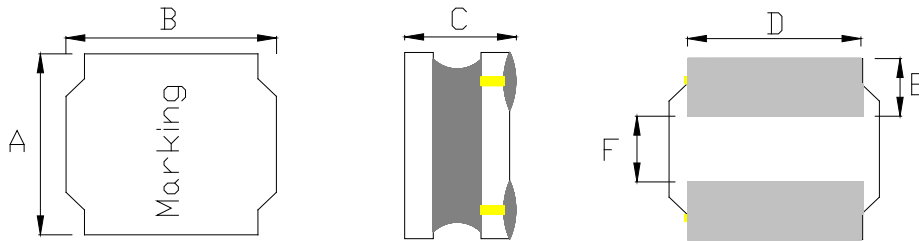

	A	B	C	D	E	F
JLCR252010	2.5 ± 0.2	2.0 ± 0.2	1.0Max	2.00	0.80	0.80

电气特性 Electrical Characteristics

JL Part Number	Inductance (uH)	Tolerance ($\pm\%$)	DCR(Ω) MAX	Isat (A) MAX	Irise(A) MAX	Test Condition	Marking
JLCR252010-R47N	0.47	30	0.056	2.35	2.15	100KHz /1.0V	R47
JLCR252010-R68N	0.68	30	0.074	2.00	1.82	100KHz /1.0V	R68
JLCR252010-1R0N	1.00	30	0.108	1.65	1.53	100KHz /1.0V	1R0
JLCR252010-2R2N	2.20	30	0.209	1.20	1.10	100KHz /1.0V	2R2
JLCR252010-3R3M	3.30	20	0.328	0.90	0.85	100KHz /1.0V	3R3
JLCR252010-4R7M	4.70	20	0.563	0.70	0.66	100KHz /1.0V	4R7
JLCR252010-6R8M	6.80	20	0.896	0.59	0.50	100KHz /1.0V	6R8

JLCR252010-100M	10.00	20	1.092	0.50	0.30	100KHz /1.0V	100
-----------------	-------	----	-------	------	------	--------------	-----

1. Isat: DC current at which the inductance drops approximate 30% from its value without current;
2. Irms: DC current that causes the temperature rise ($\Delta T = 40^{\circ} C$) from $25^{\circ} C$ ambient.
3. Operating Temperature : $-40^{\circ} C \sim +105^{\circ} C$

JLCR252012 系列

外部尺寸 External Dimensions Unit:mm

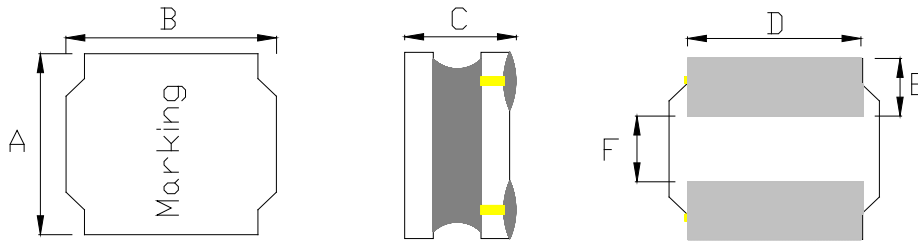

	A	B	C	D	E	F
JLCR252012	2.5 ± 0.2	2.0 ± 0.2	1.2Max	2.00	0.80	0.80

电气特性 Electrical Characteristics

JL Part Number	Inductance (uH)	Tolerance ($\pm\%$)	DCR(Ω) MAX	Isat (A) MAX	Irise(A) MAX	Test Condition	Marking
JLCR252012-R47N	0.47	30	0.061	2.15	1.95	100KHz /1.0V	R47
JLCR252012-R68N	0.68	30	0.074	1.95	1.87	100KHz /1.0V	R68
JLCR252012-1R0N	1.00	30	0.090	1.93	1.73	100KHz /1.0V	1R0
JLCR252012-2R2N	2.20	30	0.216	1.15	1.08	100KHz /1.0V	2R2
JLCR252012-3R3M	3.30	20	0.264	1.04	0.95	100KHz /1.0V	3R3
JLCR252012-4R7M	4.70	20	0.377	0.84	0.65	100KHz /1.0V	4R7
JLCR252012-5R6M	5.60	20	0.538	0.73	0.55	100KHz /1.0V	5R6

JLCR252012-6R8M	6.80	20	0.581	0.69	0.48	100KHz /1.0V	6R8
JLCR252012-8R2M	8.20	20	0.658	0.65	0.42	100KHz /1.0V	8R2
JLCR252012-100M	10.00	20	0.690	0.62	0.40	100KHz /1.0V	100
JLCR252012-120M	12.00	20	1.075	0.51	0.38	100KHz /1.0V	120
JLCR252012-150M	15.00	20	1.591	0.42	0.35	100KHz /1.0V	150
JLCR252012-220M	22.00	20	1.976	0.38	0.25	100KHz /1.0V	220

1. Isat: DC current at which the inductance drops approximate 30% from its value without current;
2. Irms: DC current that causes the temperature rise ($\Delta T = 40^{\circ} \text{C}$) from 25°C ambient.
3. Operating Temperature : $-40^{\circ} \text{C} \sim +105^{\circ} \text{C}$

JLCR 3010 系列

外部尺寸 External Dimensions Unit:mm

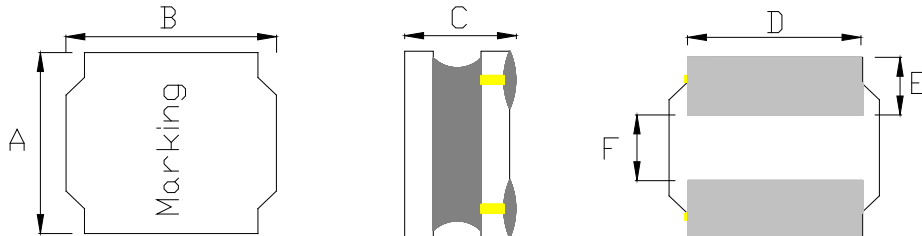

	A	B	C	D	E	F
JLCR3010	3.0 ± 0.2	3.0 ± 0.2	1.0Max	2.50	0.75	1.00

电气特性 Electrical Characteristics

JL Part Number	Inductance (uH)	Tolerance ($\pm\%$)	DCR (Ω) 30%	Isat (A)	Irise (A)	Test Condition	Marking
JLCR3010-1R0N	1.0	30	0.065	1.40	1.20	100KHz /1.0V	1R0
JLCR3010-1R2N	1.2	30	0.065	1.25	1.12	100KHz /1.0V	1R2
JLCR3010-2R2N	2.2	30	0.110	1.15	1.10	100KHz /1.0V	2R2
JLCR3010-3R3N	3.3	30	0.145	0.97	0.81	100KHz /1.0V	3R3
JLCR3010-4R7M	4.7	20	0.225	0.75	0.65	100KHz /1.0V	4R7
JLCR3010-6R8M	6.8	20	0.305	0.55	0.52	100KHz /1.0V	6R8
JLCR3010-100M	10.0	20	0.400	0.55	0.50	100KHz /1.0V	100
JLCR3010-120M	12.0	20	0.505	0.43	0.40	100KHz /1.0V	120
JLCR3010-150M	15.0	20	0.610	0.42	0.30	100KHz /1.0V	150
JLCR3010-220M	22.0	20	0.930	0.35	0.29	100KHz /1.0V	220

JLCR3010-270M	27.0	20	1.080	0.30	0.25	100KHz /1.0V	270
JLCR3010-330M	33.0	20	1.550	0.29	0.22	100KHz /1.0V	330
JLCR3010-390M	39.0	20	1.750	0.28	0.20	100KHz /1.0V	390
JLCR3010-430M	43.0	20	1.800	0.23	0.18	100KHz /1.0V	430
JLCR3010-470M	47.0	20	1.950	0.22	0.18	100KHz /1.0V	470
JLCR3010-510M	51.0	20	2.200	0.21	0.15	100KHz /1.0V	510
JLCR3010-560M	56.0	20	2.320	0.21	0.16	100KHz /1.0V	560

1. Isat: DC current at which the inductance drops approximate 30% from its value without current;
2. Irms: DC current that causes the temperature rise ($\Delta T = 40^{\circ} C$) from $25^{\circ} C$ ambient.
3. Operating Temperature : $-40^{\circ} C \sim +105^{\circ} C$

JLCR 3012 系列

外部尺寸 External Dimensions Unit:mm

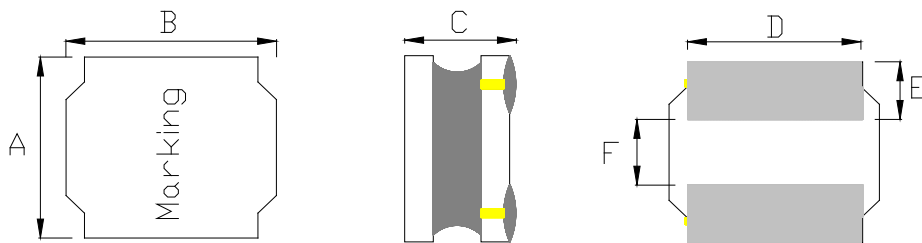

	A	B	C	D	E	F
JLCR3012	3.0 ± 0.2	3.0 ± 0.2	1.2Max	2.50	0.75	1.20

电气特性 Electrical Characteristics

JL Part Number	Inductance (uH)	Tolerance ($\pm\%$)	DCR (Ω) 30%	Isat (A)	Irise (A)	Test Condition	Marking
JLCR3012-R82N	0.82	30	0.030	2.05	1.95	100KHz /1.0V	R82
JLCR3012-1R0N	1.0	30	0.040	1.87	1.80	100KHz /1.0V	1R0
JLCR3012-2R2N	2.2	30	0.075	1.20	1.12	100KHz /1.0V	2R2
JLCR3012-3R3N	3.3	30	0.100	1.05	0.98	100KHz /1.0V	3R3
JLCR3012-4R7M	4.7	20	0.120	0.90	0.85	100KHz /1.0V	4R7
JLCR3012-6R8M	6.8	20	0.190	0.75	0.70	100KHz /1.0V	6R8
JLCR3012-100M	10.0	20	0.265	0.60	0.55	100KHz /1.0V	100
JLCR3012-120M	12.0	20	0.345	0.48	0.42	100KHz /1.0V	120
JLCR3012-150M	15.0	20	0.360	0.45	0.40	100KHz /1.0V	150
JLCR3012-180M	18.0	20	0.545	0.43	0.40	100KHz /1.0V	180

JLCR3012-220M	22.0	20	0.645	0.42	0.38	100KHz /1.0V	220
JLCR3012-270M	27.0	20	0.870	0.35	0.30	100KHz /1.0V	270
JLCR3012-330M	33.0	20	0.875	0.36	0.25	100KHz /1.0V	330
JLCR3012-390M	39.0	20	1.330	0.30	0.20	100KHz /1.0V	390
JLCR3012-470M	47.0	20	1.450	0.27	0.20	100KHz /1.0V	470
JLCR3012-680M	68.0	20	1.670	0.24	0.20	100KHz /1.0V	680
JLCR3012-820M	82.0	20	2.540	0.17	0.15	100KHz /1.0V	820
JLCR3012-101M	100.0	20	2.86	0.21	0.15	100KHz /1.0V	101

1. Isat: DC current at which the inductance drops approximate 30% from its value without current;
2. Irms: DC current that causes the temperature rise ($\Delta T = 40^{\circ} C$) from $25^{\circ} C$ ambient.
3. Operating Temperature : $-40^{\circ} C \sim +105^{\circ} C$

JLCR 3015 系列

外部尺寸 External Dimensions Unit:mm

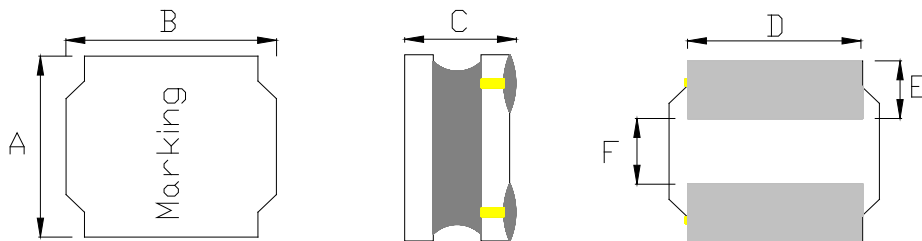

	A	B	C	D	E	F
JLCR3015	3.0 ± 0.2	3.0 ± 0.2	1.5Max	2.70	0.75	1.50

电气特性 Electrical Characteristics

JL Part Number	Inductance (uH)	Tolerance ($\pm\%$)	DCR(Ω) 30%	Isat (A)	Irise (A)	Test Condition	Marking
JLCR3015-1R0N	1.0	30	0.030	2.35	2.16	100KHz /1.0V	1R0
JLCR3015-2R2N	2.2	30	0.060	1.60	1.35	100KHz /1.0V	2R2
JLCR3015-3R3M	3.3	30	0.080	1.36	1.14	100KHz /1.0V	3R3
JLCR3015-4R7M	4.7	20	0.125	1.09	0.88	100KHz /1.0V	4R7
JLCR3015-6R8M	6.8	20	0.200	0.85	0.65	100KHz /1.0V	6R8
JLCR3015-100M	10.0	20	0.250	0.77	0.60	100KHz /1.0V	100

JLCR3015-120M	12.0	20	0.320	0.68	0.58	100KHz /1.0V	120
JLCR3015-220M	22.0	20	0.460	0.57	0.40	100KHz /1.0V	220
JLCR3015-330M	33.0	20	0.820	0.43	0.30	100KHz /1.0V	330
JLCR3015-470M	47.0	20	1.250	0.35	0.25	100KHz /1.0V	470
JLCR3015-680M	68.0	20	2.700	0.23	0.20	100KHz /1.0V	680
JLCR3015-101M	100.0	20	3.110	0.21	0.18	100KHz /1.0V	101
JLCR3015-151M	150.0	20	3.800	0.19	0.15	100KHz /1.0V	151

1. Isat: DC current at which the inductance drops approximate 30% from its value without current;
2. Irms: DC current that causes the temperature rise ($\Delta T = 40^{\circ} C$) from $25^{\circ} C$ ambient.
3. Operating Temperature : $-40^{\circ} C \sim +105^{\circ} C$

JLCR 4010 系列

外部尺寸 External Dimensions Unit:mm

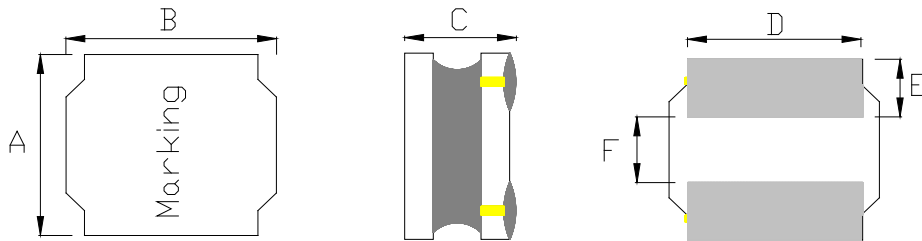

	A	B	C	D	E	F
JLCR4010	4.0 ± 0.2	4.0 ± 0.2	1.0Max	3.30	1.00	1.60

电气特性 Electrical Characteristics

JL Part Number	Inductance (uH)	Tolerance ($\pm\%$)	DCR(Ω) 30%	Isat (A)	Irise (A)	Test Condition	Marking
JLCR4010-1R0N	1.0	30	0.056	2.00	1.90	100KHz /1.0V	1R0
JLCR4010-2R2N	2.2	30	0.850	1.20	1.50	100KHz /1.0V	2R2
JLCR4010-3R3M	3.3	20	0.100	1.10	1.40	100KHz /1.0V	3R3
JLCR4010-4R7M	4.7	20	0.140	0.95	1.20	100KHz /1.0V	4R7

JLCR4010-6R8M	6.8	20	0.200	0.80	1.00	100KHz /1.0V	6R8
JLCR4010-100M	10.0	20	0.300	0.62	0.75	100KHz /1.0V	100
JLCR4010-150M	15.0	20	0.430	0.54	0.60	100KHz /1.0V	150
JLCR4010-220M	22.0	20	0.570	0.45	0.50	100KHz /1.0V	220

1. Isat: DC current at which the inductance drops approximate 30% from its value without current;
2. Irms: DC current that causes the temperature rise ($\Delta T = 40^{\circ} C$) from $25^{\circ} C$ ambient.
3. Operating Temperature : $-40^{\circ} C \sim +105^{\circ} C$

JLCR 4012 系列

外部尺寸 External Dimensions Unit:mm

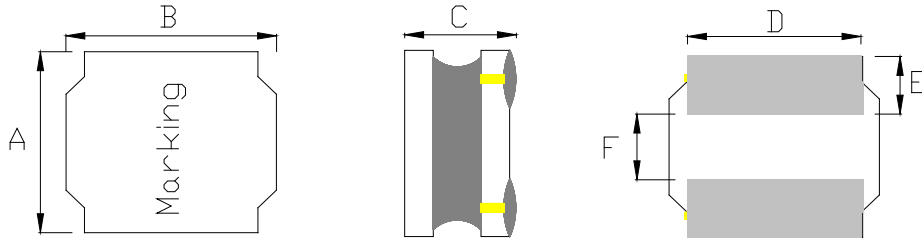

	A	B	C	D	E	F
JLCR4012	4.0 ± 0.2	4.0 ± 0.2	1.2Max	3.30	1.20	1.60

电气特性 Electrical Characteristics

JL Part Number	Inductance (μH)	Tolerance ($\pm\%$)	DCR(Ω) 30%	Isat (A)	Irise (A)	Test Condition	Marking
JLCR4012-1R0N	1.0	30	0.050	1.65	1.23	100KHz /1.0V	1R0
JLCR4012-2R2N	2.2	30	0.080	1.32	1.05	100KHz /1.0V	2R2
JLCR4012-3R3N	3.3	30	0.110	1.12	0.98	100KHz /1.0V	3R3
JLCR4012-4R7M	4.7	20	0.125	1.05	0.90	100KHz /1.0V	4R7
JLCR4012-6R8M	6.8	20	0.198	0.84	0.77	100KHz /1.0V	6R8
JLCR4012-100M	10.0	20	0.265	0.77	0.62	100KHz /1.0V	100
JLCR4012-220M	22.0	20	0.587	0.49	0.42	100KHz /1.0V	220

JLCR3015-330M	33.0	20	0.810	0.42	0.32	100KHz /1.0V	330
JLCR4012-470M	47.0	20	1.100	0.37	0.25	100KHz /1.0V	470
JLCR4012-680M	68.0	20	1.950	0.27	0.18	100KHz /1.0V	680
JLCR4012-820M	82.0	20	2.140	0.26	0.15	100KHz /1.0V	820
JLCR4012-101M	100.0	20	2.210	0.25	0.15	100KHz /1.0V	101

1. Isat: DC current at which the inductance drops approximate 30% from its value without current;
2. Irms: DC current that causes the temperature rise ($\Delta T = 40^{\circ} \text{C}$) from 25°C ambient.
3. Operating Temperature : $-40^{\circ} \text{C} \sim +105^{\circ} \text{C}$

JLCR 4018 系列

外部尺寸 External Dimensions Unit:mm

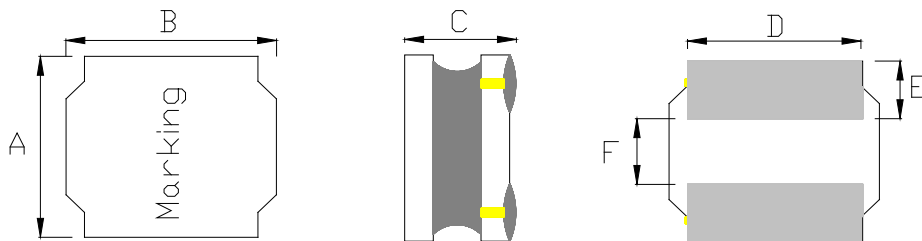

	A	B	C	D	E	F
JLCR4018	4.0 ± 0.2	4.0 ± 0.2	1.8Max	3.30	1.20	1.60

电气特性 Electrical Characteristics

JL Part Number	Inductance (uH)	Tolerance ($\pm\%$)	DCR (Ω) 30%	Isat (A)	Irise (A)	Test Condition	Marking
JLCR4018-1R0N	1.0	30	0.025	2.00	1.73	100KHz /1.0V	1R0
JLCR4018-2R2N	2.2	30	0.045	1.65	1.55	100KHz /1.0V	2R2
JLCR4018-3R3M	3.3	20	0.070	1.23	1.20	100KHz /1.0V	3R3
JLCR4018-4R7M	4.7	20	0.090	1.20	1.15	100KHz /1.0V	4R7
JLCR4018-6R8M	6.8	20	0.110	1.06	1.00	100KHz /1.0V	6R8
JLCR4018-100M	10.0	20	0.180	0.84	0.80	100KHz /1.0V	100

JLCR4018-150M	15.0	20	0.250	0.65	0.60	100KHz /1.0V	150
JLCR4018-220M	22.0	20	0.360	0.59	0.50	100KHz /1.0V	220
JLCR4018-330M	33.0	20	0.530	0.49	0.42	100KHz /1.0V	330
JLCR4018-470M	47.0	20	0.650	0.42	0.40	100KHz /1.0V	470
JLCR4018-680M	68.0	20	1.000	0.32	0.30	100KHz /1.0V	680
JLCR4018-101M	100.0	20	1.750	0.25	0.25	100KHz /1.0V	101
JLCR4018-151M	150.0	20	2.500	0.22	0.20	100KHz /1.0V	151
JLCR4018-221M	220.0	20	4.000	0.17	0.15	100KHz /1.0V	221

1. Isat: DC current at which the inductance drops approximate 30% from its value without current;
2. Irms: DC current that causes the temperature rise ($\Delta T = 40^{\circ} C$) from $25^{\circ} C$ ambient.
3. Operating Temperature : $-40^{\circ} C \sim +105^{\circ} C$

JLCR 4020 系列

外部尺寸 External Dimensions Unit:mm

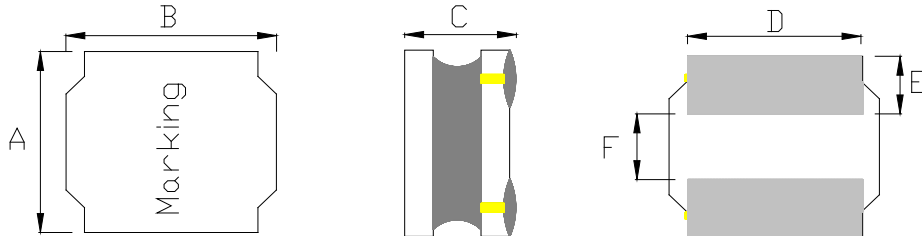

	A	B	C	D	E	F
JLCR4020	4.0 ± 0.2	4.0 ± 0.2	2.0Max	3.30	1.20	1.60

电气特性 Electrical Characteristics

JL Part Number	Inductance (uH)	Tolerance ($\pm\%$)	DCR (Ω) 30%	Isat (A)	Irise (A)	Test Condition	Marking
JLCR4020-1R0N	1.0	30	0.029	2.15	2.01	100KHz /1.0V	1R0
JLCR4020-2R2N	2.2	30	0.040	1.85	1.75	100KHz /1.0V	2R2
JLCR4020-3R3M	3.3	20	0.070	1.40	1.30	100KHz /1.0V	3R3
JLCR4020-4R7M	4.7	20	0.075	1.34	1.15	100KHz /1.0V	4R7
JLCR4020-5R6M	5.6	20	0.090	1.22	1.02	100KHz /1.0V	5R6
JLCR4020-6R8M	6.8	20	0.125	1.04	0.93	100KHz /1.0V	6R8
JLCR4020-8R2M	8.2	20	0.125	1.04	0.86	100KHz /1.0V	8R2
JLCR4020-100M	10.0	20	0.165	0.90	0.82	100KHz /1.0V	100
JLCR4020-120M	12.0	20	0.175	0.88	0.75	100KHz /1.0V	120

JLCR4020-150M	15.0	20	0.230	0.77	0.69	100KHz /1.0V	150
JLCR4020-220M	22.0	20	0.350	0.62	0.60	100KHz /1.0V	220
JLCR4020-270M	27.0	20	0.545	0.50	0.43	100KHz /1.0V	270
JLCR4020-330M	33.0	20	0.550	0.49	0.40	100KHz /1.0V	330
JLCR4020-390M	39.0	20	0.650	0.46	0.38	100KHz /1.0V	390
JLCR4020-470M	47.0	20	0.710	0.44	0.31	100KHz /1.0V	470
JLCR4020-560M	56.0	20	0.800	0.41	0.19	100KHz /1.0V	560
JLCR4020-680M	68.0	20	1.060	0.36	0.15	100KHz /1.0V	680
JLCR4020-820M	82.0	20	1.170	0.34	0.15	100KHz /1.0V	820
JLCR4020-101M	100.0	20	1.550	0.31	0.15	100KHz /1.0V	101

1. Isat: DC current at which the inductance drops approximate 30% from its value without current;
2. Irms: DC current that causes the temperature rise ($\Delta T = 40^{\circ} \text{C}$) from 25°C ambient.
3. Operating Temperature : $-40^{\circ} \text{C} \sim +105^{\circ} \text{C}$

JLCR 5020 系列

外部尺寸 External Dimensions Unit:mm

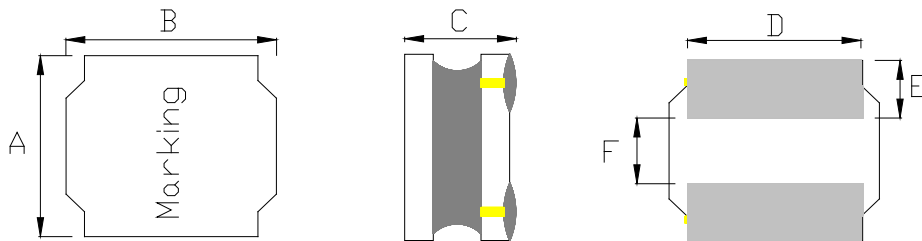

	A	B	C	D	E	F
JLCR5020	5.0 ± 0.2	5.0 ± 0.2	2.0Max	4.20	1.50	2.00

电气特性 Electrical Characteristics

JL Part Number	Inductance (uH)	Tolerance ($\pm\%$)	DCR(Ω) 30%	Isat (A)	Irise (A)	Test Condition	Marking
JLCR5020-R47N	0.47	30	0.013	4.60	3.85	100KHz /1.0V	R47
JLCR5020-1R0N	1.0	30	0.020	3.80	3.50	100KHz /1.0V	1R0
JLCR5020-2R2N	2.2	30	0.032	2.90	2.65	100KHz /1.0V	2R2
JLCR5020-3R3N	3.3	30	0.043	2.50	2.18	100KHz /1.0V	3R3
JLCR5020-4R7M	4.7	20	0.057	2.20	1.79	100KHz /1.0V	4R7
JLCR5020-5R6M	5.6	20	0.064	2.05	1.50	100KHz /1.0V	5R6
JLCR5020-6R8M	6.8	20	0.083	1.80	1.46	100KHz /1.0V	6R8

JLCR5020-8R2M	8.2	20	0.098	1.65	1.26	100KHz /1.0V	8R2
JLCR5020-100M	10.0	20	0.110	1.55	1.20	100KHz /1.0V	100
JLCR5020-220M	22.0	20	0.226	1.10	0.70	100KHz /1.0V	220
JLCR5020-330M	33.0	20	0.390	0.90	0.65	100KHz /1.0V	330
JLCR5020-470M	47.0	20	0.523	0.77	0.52	100KHz /1.0V	470
JLCR5020-680M	68.0	20	0.740	0.64	0.40	100KHz /1.0V	680
JLCR5020-820M	82.0	20	0.965	0.50	0.30	100KHz /1.0V	820
JLCR5020-101M	100.0	20	1.100	0.40	0.30	100KHz /1.0V	101

1. Isat: DC current at which the inductance drops approximate 30% from its value without current;
2. Irms: DC current that causes the temperature rise ($\Delta T = 40^{\circ} C$) from $25^{\circ} C$ ambient.
3. Operating Temperature : $-40^{\circ} C \sim +105^{\circ} C$

JLCR 5040 系列

外部尺寸 External Dimensions Unit:mm

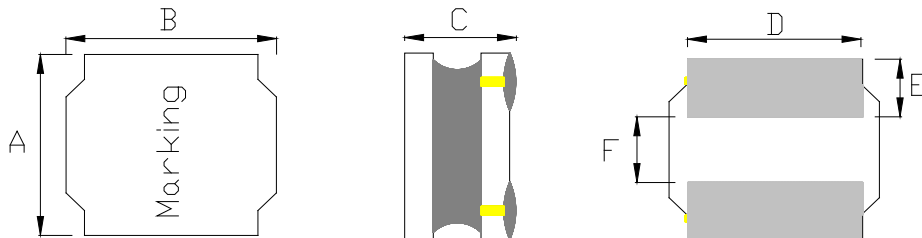

	A	B	C	D	E	F
JLCR5040	5.0 ± 0.2	5.0 ± 0.2	4.0Max	4.20	1.50	2.00

电气特性 Electrical Characteristics

JL Part Number	Inductance (uH)	Tolerance ($\pm\%$)	DCR (Ω) 30%	Isat (A)	Irise (A)	Test Condition	Marking
JLCR5040-1R0N	1.00	30	0.012	4.90	4.00	100KHz /1.0V	1R0
JLCR5040-2R2N	2.2	30	0.019	3.80	3.32	100KHz /1.0V	2R2
JLCR5040-3R3N	3.3	30	0.024	3.40	3.00	100KHz /1.0V	3R3
JLCR5040-4R7M	4.7	20	0.030	3.00	2.70	100KHz /1.0V	4R7
JLCR5040-5R6M	5.6	20	0.035	2.80	2.60	100KHz /1.0V	5R6
JLCR5040-6R8M	6.8	20	0.043	2.50	2.32	100KHz /1.0V	6R8

JLCR5040-100M	10.0	20	0.064	2.10	1.86	100KHz /1.0V	100
JLCR5040-220M	22.0	20	0.129	1.50	1.33	100KHz /1.0V	220
JLCR5040-330M	33.0	20	0.188	1.20	1.16	100KHz /1.0V	330
JLCR5040-470M	47.0	20	0.272	1.00	1.00	100KHz /1.0V	470
JLCR5040-680M	68.0	20	0.400	0.80	0.86	100KHz /1.0V	680
JLCR5040-101M	100.0	20	0.560	0.70	0.52	100KHz /1.0V	101
JLCR5040-221M	220.0	20	1.280	0.38	0.20	100KHz /1.0V	221

1. Isat: DC current at which the inductance drops approximate 30% from its value without current;
2. Irms: DC current that causes the temperature rise ($\Delta T = 40^{\circ} C$) from $25^{\circ} C$ ambient.
3. Operating Temperature : $-40^{\circ} C \sim +105^{\circ} C$

JLCR 6020 系列

外部尺寸 External Dimensions Unit:mm

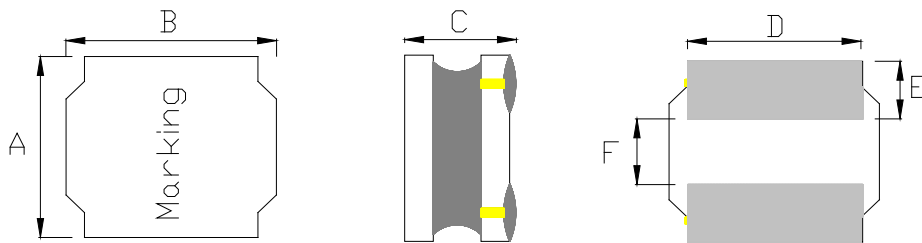

	A	B	C	D	E	F
JLCR6020	6.0 ± 0.3	6.0 ± 0.3	2.0Max	5.70	1.70	2.60

电气特性 Electrical Characteristics

JL Part Number	Inductance (uH)	Tolerance ($\pm\%$)	DCR (Ω) 30%	Isat (A)	Irise (A)	Test Condition	Marking
JLCR6020-R68N	0.68	30	0.017	3.70	3.00	100KHz /1.0V	R68
JLCR6020-1R0N	1.0	30	0.020	3.50	2.74	100KHz /1.0V	1R0
JLCR6020-2R2N	2.2	30	0.028	2.75	2.25	100KHz /1.0V	2R2
JLCR6020-3R3N	3.3	30	0.035	2.60	2.16	100KHz /1.0V	3R3
JLCR6020-4R7M	4.7	20	0.058	2.00	1.71	100KHz /1.0V	4R7
JLCR6020-6R8M	6.8	20	0.079	1.80	1.48	100KHz /1.0V	6R8

JLCR6020-8R2M	8.2	20	0.105	1.40	1.30	100KHz /1.0V	8R2
JLCR6020-100M	10.0	20	0.105	1.40	1.22	100KHz /1.0V	100
JLCR6020-180M	18.0	20	0.180	1.08	1.00	100KHz /1.0V	180
JLCR6020-220M	22.0	20	0.204	1.00	0.80	100KHz /1.0V	220
JLCR6020-330M	33.0	20	0.300	0.84	0.65	100KHz /1.0V	330
JLCR6020-470M	47.0	20	0.430	0.80	0.50	100KHz /1.0V	470

1. Isat: DC current at which the inductance drops approximate 30% from its value without current;
2. Irms: DC current that causes the temperature rise ($\Delta T = 40^{\circ} C$) from $25^{\circ} C$ ambient.
3. Operating Temperature : $-40^{\circ} C \sim +105^{\circ} C$

JLCR 6028 系列

外部尺寸 External Dimensions Unit:mm

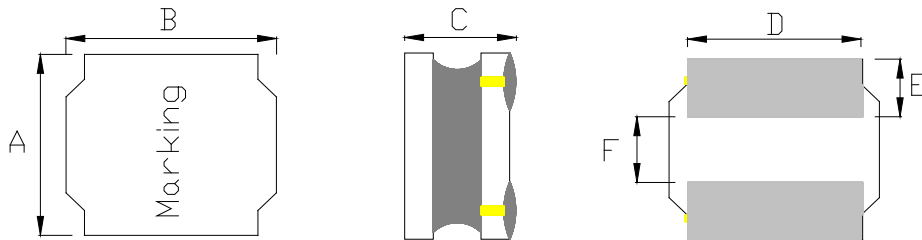

	A	B	C	D	E	F
JLCR6028	6.0 ± 0.3	6.0 ± 0.3	2.8Max	5.70	1.70	2.60

电气特性 Electrical Characteristics

JL Part Number	Inductance (uH)	Tolerance ($\pm\%$)	DCR (Ω) 30%	Isat (A)	Irise (A)	Test Condition	Marking
JLCR6028-1R0N	1.00	30	0.010	5.20	4.85	100KHz /1.0V	1R0
JLCR6028-2R2N	2.20	30	0.020	3.75	3.50	100KHz /1.0V	2R2
JLCR6028-3R3N	3.3	30	0.025	3.48	3.20	100KHz /1.0V	3R3
JLCR6028-4R7N	4.7	30	0.030	3.08	2.84	100KHz /1.0V	4R7
JLCR6028-6R8M	6.8	20	0.047	2.40	2.20	100KHz /1.0V	6R8
JLCR6028-8R2M	8.2	20	0.055	2.25	2.00	100KHz /1.0V	8R2
JLCR6028-100M	10.0	20	0.072	1.95	1.62	100KHz /1.0V	100

JLCR6028-220M	22.0	20	0.140	1.40	1.06	100KHz /1.0V	220
JLCR6028-330M	33.0	20	0.185	1.22	0.85	100KHz /1.0V	330
JLCR6028-470M	47.0	20	0.315	1.06	0.70	100KHz /1.0V	470
JLCR6028-680M	68.0	20	0.360	0.86	0.62	100KHz /1.0V	680
JLCR6028-750M	75.0	20	0.410	0.81	0.53	100KHz /1.0V	750
JLCR6028-820M	82.0	20	0.500	0.70	0.50	100KHz /1.0V	820
JLCR6028-101M	100.0	20	0.500	0.70	0.40	100KHz /1.0V	101

1. Isat: DC current at which the inductance drops approximate 30% from its value without current;
2. Irms: DC current that causes the temperature rise ($\Delta T = 40^{\circ} \text{C}$) from 25°C ambient.
3. Operating Temperature : $-40^{\circ} \text{C} \sim +105^{\circ} \text{C}$

JLCR 6045 系列

外部尺寸 External Dimensions Unit:mm

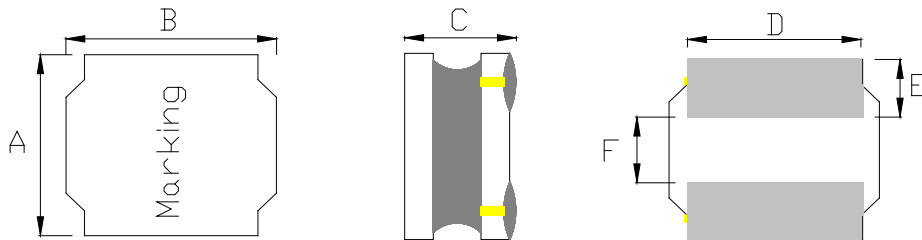

	A	B	C	D	E	F
JLCR6045	6.0 ± 0.3	6.0 ± 0.3	4.5Max	5.70	1.70	2.60

电气特性 Electrical Characteristics

JL Part Number	Inductance (uH)	Tolerance ($\pm\%$)	DCR (Ω) 30%	Isat (A)	Irise (A)	Test Condition	Marking
JLCR6045-R82N	0.82	30	0.008	5.90	5.50	100KHz /1.0V	R82
JLCR6045-1R0N	1.00	30	0.011	5.14	4.80	100KHz /1.0V	1R0
JLCR6045-2R2N	2.2	30	0.014	4.60	3.86	100KHz /1.0V	2R2
JLCR6045-3R3N	3.3	30	0.021	3.70	3.30	100KHz /1.0V	3R3
JLCR6045-4R7M	4.7	20	0.026	3.30	3.00	100KHz /1.0V	4R7
JLCR6045-5R6M	5.6	20	0.029	3.15	2.63	100KHz /1.0V	5R6

JLCR6045-6R8M	6.8	20	0.031	3.00	2.51	100KHz /1.0V	6R8
JLCR6045-8R2M	8.2	20	0.043	2.60	2.18	100KHz /1.0V	8R2
JLCR6045-100M	10.0	20	0.048	2.45	1.98	100KHz /1.0V	100
JLCR6045-220M	22.0	20	0.089	1.80	1.50	100KHz /1.0V	220
JLCR6045-330M	33.0	20	0.137	1.45	1.15	100KHz /1.0V	330

1. Isat: DC current at which the inductance drops approximate 30% from its value without current;
2. Irms: DC current that causes the temperature rise ($\Delta T = 40^{\circ} \text{C}$) from 25°C ambient.
3. Operating Temperature : $-40^{\circ} \text{C} \sim +105^{\circ} \text{C}$

JLCR 8040 系列

外部尺寸 External Dimensions Unit:mm

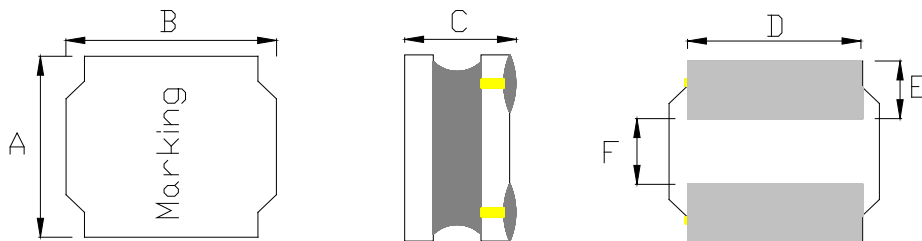

	A	B	C	D	E	F
JLCR8040	8.0 ± 0.3	6.0 ± 0.3	4.2Max	7.50	2.10	3.80

电气特性 Electrical Characteristics

JL Part Number	Inductance (uH)	Tolerance ($\pm\%$)	DCR (Ω) 30%	Isat (A)	Irise (A)	Test Condition	Marking
JLCR8040-R82N	0.82	30	0.008	6.30	5.25	100KHz /1.0V	R82
JLCR8040-1R0N	1.00	30	0.008	6.30	5.16	100KHz /1.0V	1R0
JLCR8040-2R2N	2.2	30	0.012	5.15	4.81	100KHz /1.0V	2R2
JLCR8040-3R3N	3.3	30	0.017	4.40	3.80	100KHz /1.0V	3R3
JLCR8040-4R7N	4.7	30	0.019	4.10	3.56	100KHz /1.0V	4R7
JLCR8040-6R8M	6.8	20	0.024	3.60	3.20	100KHz /1.0V	6R8
JLCR8040-8R2M	8.2	20	0.026	3.45	3.15	100KHz /1.0V	8R2

JLCR8040-100M	10.0	20	0.042	3.30	3.00	100KHz /1.0V	100
JLCR8040-220M	22.0	20	0.069	2.10	1.86	100KHz /1.0V	220
JLCR8040-330M	33.0	20	0.097	1.80	1.62	100KHz /1.0V	330
JLCR8040-470M	47.0	20	0.136	1.55	1.38	100KHz /1.0V	470
JLCR8040-560M	56.0	20	0.148	1.45	1.30	100KHz /1.0V	560
JLCR8040-680M	68.0	20	0.196	1.25	1.12	100KHz /1.0V	680
JLCR8040-820M	82.0	20	0.225	1.15	1.00	100KHz /1.0V	820
JLCR8040-101M	100.0	20	0.290	1.00	0.88	100KHz /1.0V	101
JLCR8040-221M	220.0	20	0.599	0.80	0.40	100KHz /1.0V	221
JLCR8040-331M	330.0	20	0.889	0.64	0.30	100KHz /1.0V	331

1. Isat: DC current at which the inductance drops approximate 30% from its value without current;
2. Irms: DC current that causes the temperature rise ($\Delta T = 40^{\circ} \text{C}$) from 25°C ambient.
3. Operating Temperature : $-40^{\circ} \text{C} \sim +105^{\circ} \text{C}$

JLCD 0301 系列

外部尺寸 External Dimensions Unit:mm

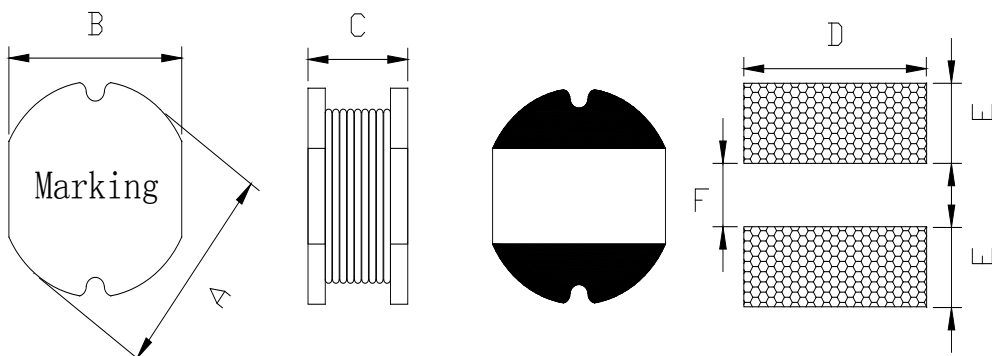

	A	B	C	D	E	F
JLCD0301	3.5 ± 0.3	3.0 ± 0.3	1.15 ± 0.3	3.50	1.60	0.80

电气特性 Electrical Characteristics

JL Part Number	Inductance (uH)	Tolerance ($\pm\%$)	DCR(Ω) MAX	Isat (A) MAX	Irise(A) MAX	Test Condition	Marking
JLCD0301-1R0N	1.0	30	0.060	1.40	1.40	100KHz, 0.25V	1R1
JLCD0301-2R2N	2.2	30	0.240	1.20	1.20	100KHz, 0.25V	2R2
JLCD0301-3R3M	3.3	20	0.270	1.00	1.00	100KHz, 0.25V	3R3

JLCD0301-4R7M	4.7	20	0.400	0.90	0.90	100KHz, 0.25V	4R7
JLCD0301-5R6M	5.6	20	0.450	0.65	0.65	100KHz, 0.25V	5R6
JLCD0301-6R8M	6.8	20	0.500	0.56	0.56	100KHz, 0.25V	6R8
JLCD0301-100M	10.0	20	0.750	0.45	0.45	1KHz, 0.25V	100
JLCD0301-220M	22.0	20	1.500	0.28	0.28	1KHz, 0.25V	220
JLCD0301-330M	33.0	20	2.800	0.25	0.25	1KHz, 0.25V	330
JLCD0301-470M	47.0	20	4.000	0.21	0.21	1KHz, 0.25V	470
JLCD0301-680M	68.0	20	5.000	0.18	0.18	1KHz, 0.25V	680

1. Isat: DC current at which the inductance drops approximate 30% from its value without current;
2. Irms: DC current that causes the temperature rise ($\Delta T = 40^{\circ} \text{C}$) from 25°C ambient.
3. Operating Temperature : $-40^{\circ} \text{C} \sim +105^{\circ} \text{C}$

JLCD 0302 系列

外部尺寸 External Dimensions Unit:mm

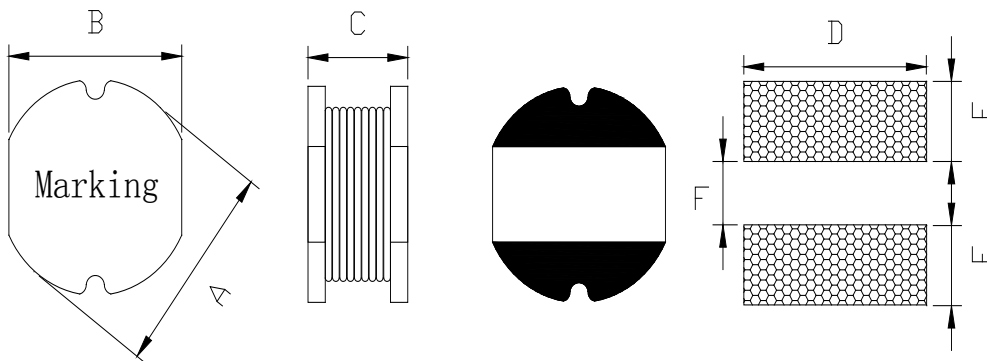

	A	B	C	D	E	F
JLCD0302	3.5 ± 0.3	3.0 ± 0.3	2.1 ± 0.3	3.50	1.60	0.80

电气特性 Electrical Characteristics

JL Part Number	Inductance (uH)	Tolerance ($\pm\%$)	DCR(Ω) MAX	Isat (A) MAX	Irise(A) MAX	TestCondition	Marking
JLCD0302-1R0N	1.00	30	0.045	2.200	2.200	100KHz, 0.25V	1R0
JLCD0302-2R2N	2.20	30	0.085	1.600	1.600	100KHz, 0.25V	2R2
JLCD0302-3R3M	3.30	20	0.120	1.040	1.040	100KHz, 0.25V	3R3

JLCD0302-4R7M	4.70	20	0.170	1.000	1.000	100KHz, 0.25V	4R7
JLCD0302-5R6M	5.60	20	0.185	0.950	0.950	100KHz, 0.25V	5R6
JLCD0302-6R8M	6.80	20	0.200	0.950	0.950	100KHz, 0.25V	6R8
JLCD0302-100M	10.00	20	0.320	0.760	0.760	1KHz, 0.25V	100
JLCD0302-220M	22.00	20	0.660	0.500	0.500	1KHz, 0.25V	220
JLCD0302-330M	33.00	20	0.920	0.380	0.380	1KHz, 0.25V	330
JLCD0302-470M	47.00	20	1.270	0.330	0.330	1KHz, 0.25V	470
JLCD0302-680M	68.00	20	2.000	0.260	0.260	1KHz, 0.25V	680
JLCD0302-101M	100.00	20	2.850	0.200	0.200	1KHz, 0.25V	101

1. Isat: DC current at which the inductance drops approximate 30% from its value without current;
2. Irms: DC current that causes the temperature rise ($\Delta T = 40^{\circ}C$) from $25^{\circ}C$ ambient.
3. Operating Temperature : $-40^{\circ}C \sim +105^{\circ}C$

JLCD 0403 系列

外部尺寸 External Dimensions Unit:mm

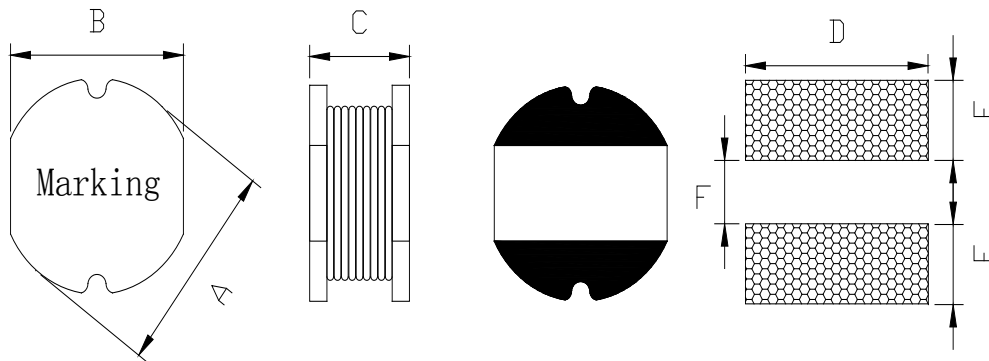

	A	B	C	D	E	F
JLCD0403	4.5 ± 0.3	4.0 ± 0.3	3.2 ± 0.3	4.50	1.75	1.50

电气特性 Electrical Characteristics

JL Part Number	Inductance (uH)	Tolerance ($\pm\%$)	DCR(Ω) MAX	Isat (A) MAX	Irise(A) MAX	TestCondition	Marking
JLCD0403-1R0N	1.00	30	0.049	2.700	2.700	100KHz, 0.25V	1R0
JLCD0403-2R2N	2.20	30	0.072	2.250	2.250	100KHz, 0.25V	2R2
JLCD0403-3R3M	3.30	20	0.086	2.000	2.000	100KHz, 0.25V	3R3

JLCD0403-4R7M	4.70	20	0.109	1.620	1.620	100KHz, 0.25V	4R7
JLCD0403-5R6M	5.60	20	0.126	1.480	1.480	100KHz, 0.25V	5R6
JLCD0403-6R8M	6.80	20	0.131	1.430	1.430	100KHz, 0.25V	6R8
JLCD0403-100M	10.00	20	0.182	1.040	1.040	1KHz, 0.25V	100
JLCD0403-220M	22.00	20	0.378	0.680	0.680	1KHz, 0.25V	220
JLCD0403-330M	33.00	20	0.540	0.560	0.560	1KHz, 0.25V	330
JLCD0403-470M	47.00	20	0.844	0.440	0.440	1KHz, 0.25V	470
JLCD0403-680M	68.00	20	1.117	0.370	0.370	1KHz, 0.25V	680
JLCD0403-101M	100.00	20	1.190	0.300	0.300	1KHz, 0.25V	101

1. Isat: DC current at which the inductance drops approximate 30% from its value without current;
2. Irms: DC current that causes the temperature rise ($\Delta T = 40^{\circ} C$) from $25^{\circ} C$ ambient.
3. Operating Temperature : $-40^{\circ} C \sim +105^{\circ} C$

JLCD 0502 系列

外部尺寸 External Dimensions Unit:mm

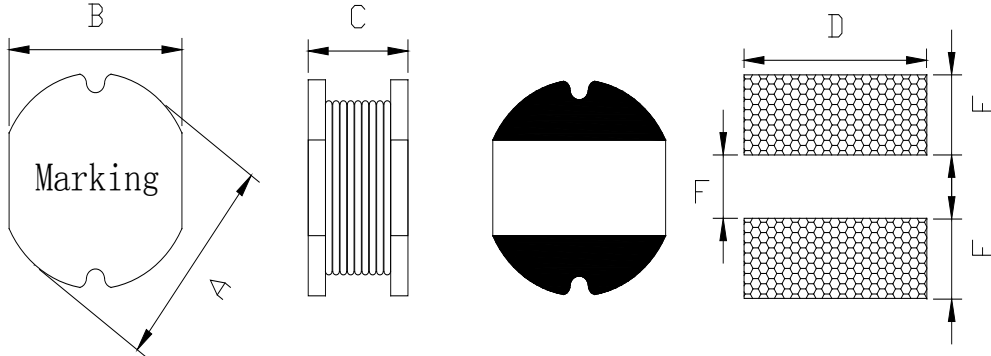

	A	B	C	D	E	F
JLCD0502	5.8 ± 0.3	5.2 ± 0.3	2.5 ± 0.3	5.50	2.15	1.70

电气特性 Electrical Characteristics

JL Part Number	Inductance (uH)	Tolerance (±%)	DCR(Ω) MAX	Isat (A)	Irise (A)	Test Condition	Marking
JLCD0502-1R0N	1.00	30	0.021	4.000	4.000	100KHz, 0.25V	1R0
JLCD0502-2R2N	2.20	30	0.070	3.500	3.500	100KHz, 0.25V	2R2
JLCD0502-3R3M	3.30	20	0.100	2.700	2.700	100KHz, 0.25V	3R3

JLCD0502-4R7M	4.70	20	0.140	2.000	2.000	100KHz, 0.25V	4R7
JLCD0502-5R6M	5.60	20	0.150	1.800	1.800	100KHz, 0.25V	5R6
JLCD0502-6R8M	6.80	20	0.160	1.500	1.500	100KHz, 0.25V	6R8
JLCD0502-100M	10.00	20	0.200	1.300	1.300	1KHz, 0.25V	100
JLCD0502-220M	22.00	20	0.350	0.900	0.900	1KHz, 0.25V	220
JLCD0502-330M	33.00	20	0.500	0.750	0.750	1KHz, 0.25V	330
JLCD0502-470M	47.00	20	0.650	0.600	0.600	1KHz, 0.25V	470
JLCD0502-680M	68.00	20	0.950	0.500	0.500	1KHz, 0.25V	680
JLCD0502-101M	100.00	20	1.400	0.400	0.400	1KHz, 0.25V	101

1. Isat: DC current at which the inductance drops approximate 30% from its value without current;
2. Irms: DC current that causes the temperature rise ($\Delta T = 40^{\circ} \text{C}$) from 25°C ambient.
3. Operating Temperature : $-40^{\circ} \text{C} \sim +105^{\circ} \text{C}$

JLCD 0503 系列

外部尺寸 External Dimensions Unit:mm

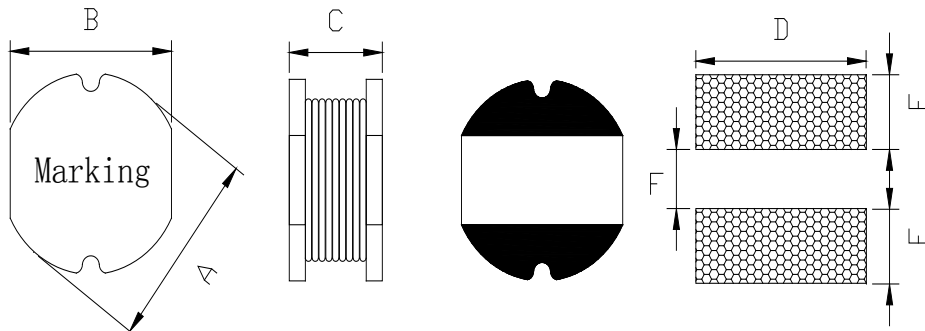

	A	B	C	D	E	F
JLCD0503	5.8 ± 0.3	5.2 ± 0.3	3.0 ± 0.3	5.50	2.15	1.70

电气特性 Electrical Characteristics

JL Part Number	Inductance (μH)	Tolerance ($\pm\%$)	DCR (Ω) 30%	Isat (A)	Irise (A)	Test Condition	Marking
JLCD0503-1R0N	1.0	30	16.50m	3.70	3.70	100KHz /0.25V	1R0
JLCD0503-2R2N	2.2	30	25.00m	2.85	2.85	100KHz /0.25V	2R2
JLCD0503-3R3M	3.3	20	39.50m	2.40	2.40	100KHz /0.25V	3R3
JLCD0503-4R7M	4.7	20	52.00m	1.90	1.90	100KHz /0.25V	4R7
JLCD0503-6R8M	6.8	20	71.20m	1.87	1.87	100KHz /0.25V	6R8
JLCD0503-100M	10	20	93.60m	1.78	1.78	1KHz /0.25V	100
JLCD0503-150M	15	20	139.00m	1.58	1.58	1KHz /0.25V	150
JLCD0503-220M	22	20	192.40m	1.29	1.29	1KHz /0.25V	220
JLCD0503-330M	33	20	325.00m	950m	950m	1KHz /0.25V	330

JLCD0503-390M	39	20	369.00m	920m	920m	1KHz /0.25V	390
JLCD0503-470M	47	20	435.50m	820m	820m	1KHz /0.25V	470
JLCD0503-560M	56	20	552.50m	800m	800m	1KHz /0.25V	560
JLCD0503-680M	68	20	628.00m	760m	760m	1KHz /0.25V	680
JLCD0503-820M	82	20	785.00m	670m	670m	1KHz /0.25V	820
JLCD0503-101M	100	20	848.00m	615m	615m	1KHz /0.25V	101
JLCD0503-121M	120	20	1.03	600m	600m	1KHz /0.25V	121
JLCD0503-151M	150	20	1.44	480m	480m	1KHz /0.25V	151
JLCD0503-221M	220	20	2.08	370m	370m	1KHz /0.25V	221
JLCD0503-331M	330	20	3.71	300m	300m	1KHz /0.25V	331
JLCD0503-471M	470	20	4.42	235m	235m	1KHz /0.25V	471
JLCD0503-681M	680	20	6.42	210m	210m	1KHz /0.25V	681

1. Isat: DC current at which the inductance drops approximate 30% from its value without current;
2. Irms: DC current that causes the temperature rise ($\Delta T = 40^{\circ} C$) from $25^{\circ} C$ ambient.
3. Operating Temperature : $-40^{\circ} C \sim +105^{\circ} C$

JLCD 0504 系列

外部尺寸 External Dimensions Unit:mm

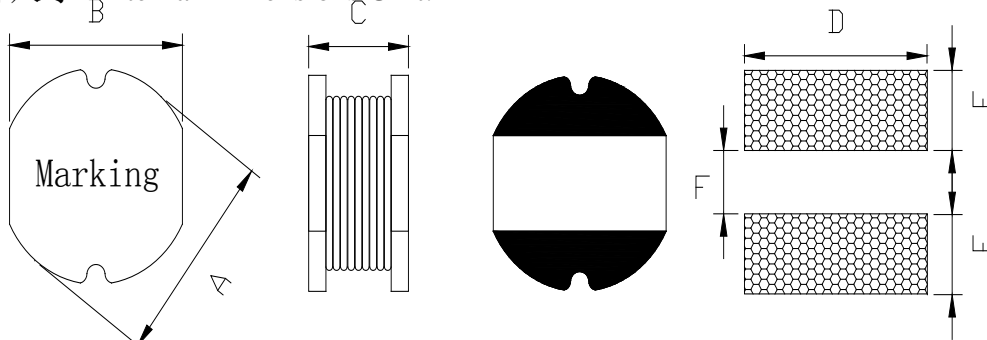

	A	B	C	D	E	F
JLCD0504	5.8 ± 0.3	5.2 ± 0.3	4.5 ± 0.3	5.50	2.15	1.70

电气特性 Electrical Characteristics

JL Part Number	Inductance (uH)	Tolerance ($\pm\%$)	DCR(Ω) MAX	Isat (A)	Irise (A)	Test Condition	Marking
JLCD0504-1R0N	1.0	30	13.00m	5.40	5.40	100KHz /0.25V	1R0
JLCD0504-2R2N	2.2	30	22.10m	4.00	4.00	100KHz /0.25V	2R2
JLCD0504-3R3N	3.3	30	31.20m	3.70	3.70	100KHz /0.25V	3R3
JLCD0504-4R7M	4.7	20	52.00m	3.00	3.00	100KHz /0.25V	4R7
JLCD0504-5R6M	5.6	20	54.60m	2.80	2.80	100KHz /0.25V	5R6
JLCD0504-6R8M	6.8	20	58.50m	2.40	2.40	100KHz /0.25V	6R8
JLCD0504-100M	10	20	87.90m	1.42	1.42	1KHz /0.25V	100
JLCD0504-220M	22	20	169.00m	1.10	1.10	1KHz /0.25V	220

JLCD0504-270M	27	20	153.40m	0.95	0.95	1KHz /0.25V	270
JLCD0504-330M	33	20	208.00m	0.86	0.86	1KHz /0.25V	330
JLCD0504-470M	47	20	355.00m	0.71	0.71	1KHz /0.25V	470
JLCD0504-680M	68	20	390.00m	0.6	0.6	1KHz /0.25V	680
JLCD0504-101M	100	20	611.00m	0.51	0.51	1KHz /0.25V	101
JLCD0504-221M	220	20	1.45	0.34	0.34	1KHz /0.25V	221
JLCD0504-271M	270	20	1.51	0.31	0.31	1KHz /0.25V	271
JLCD0504-331M	330	20	1.76	0.28	0.28	1KHz /0.25V	331
JLCD0504-471M	470	20	2.99	0.24	0.24	1KHz /0.25V	471
JLCD0504-561M	560	20	3.12	0.22	0.22	1KHz /0.25V	561
JLCD0504-681M	680	20	3.90	0.2	0.2	1KHz /0.25V	681

1. Isat: DC current at which the inductance drops approximate 30% from its value without current;
2. Irms: DC current that causes the temperature rise ($\Delta T = 40^{\circ} C$) from $25^{\circ} C$ ambient.
3. Operating Temperature : $-40^{\circ} C \sim +105^{\circ} C$

JLCD 0703 系列

外部尺寸 External Dimensions Unit:mm

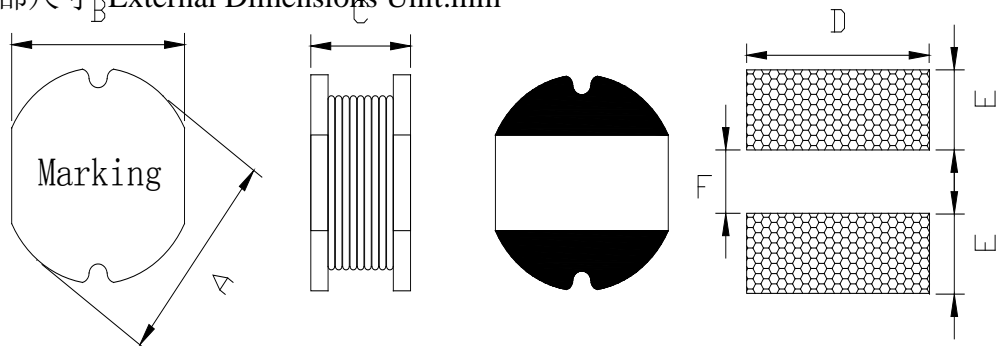

	A	B	C	D	E	F
JLCD0703	7.8 ± 0.3	7.0 ± 0.3	3.5 ± 0.5	7.50	3.00	2.00

电气特性 Electrical Characteristics

JL Part Number	Inductance (uH)	Tolerance ($\pm\%$)	DCR (Ω) MAX	Isat (A)	Irise (A)	TestCondition	Marking
JLCD0703-1R0N	1.0	30	0.018	1.64	1.64	100KHz /0.25V	1R0
JLCD0703-2R2N	2.2	30	0.023	1.60	1.60	100KHz /0.25V	2R2
JLCD0703-3R3M	3.3	20	0.025	1.59	1.59	100KHz /0.25V	3R3
JLCD0703-4R7M	4.7	20	0.039	1.54	1.54	100KHz /0.25V	4R7
JLCD0703-6R8M	6.8	20	0.040	1.49	1.49	100KHz /0.25V	6R8
JLCD0703-100M	10	20	0.080	1.44	1.44	1KHz /0.25V	100
JLCD0703-180M	18	20	0.111	1.12	1.12	1KHz /0.25V	180
JLCD0703-220M	22	20	0.129	1.07	1.07	1KHz /0.25V	220

JLCD0703-330M	33	20	0.170	0.85	0.85	1KHz /0.25V	330
JLCD0703-470M	47	20	0.252	0.68	0.68	1KHz /0.25V	470
JLCD0703-560M	56	20	0.282	0.64	0.64	1KHz /0.25V	560
JLCD0703-680M	68	20	0.332	0.59	0.59	1KHz /0.25V	680
JLCD0703-101M	100	20	0.481	0.51	0.51	1KHz /0.25V	101
JLCD0703-181M	180	20	1.022	0.36	0.36	1KHz /0.25V	181
JLCD0703-221M	220	20	1.200	0.31	0.31	1KHz /0.25V	221
JLCD0703-331M	330	20	1.495	0.28	0.28	1KHz /0.25V	331
JLCD0703-471M	470	20	2.100	0.26	0.26	1KHz /0.25V	471
JLCD0703-681M	680	20	3.000	0.23	0.23	1KHz /0.25V	681

1. Isat: DC current at which the inductance drops approximate 30% from its value without current;
2. Irms: DC current that causes the temperature rise ($\Delta T = 40^{\circ} C$) from $25^{\circ} C$ ambient.
3. Operating Temperature : $-40^{\circ} C \sim +105^{\circ} C$

JLCD 0705 系列

外部尺寸 External Dimensions Unit:mm

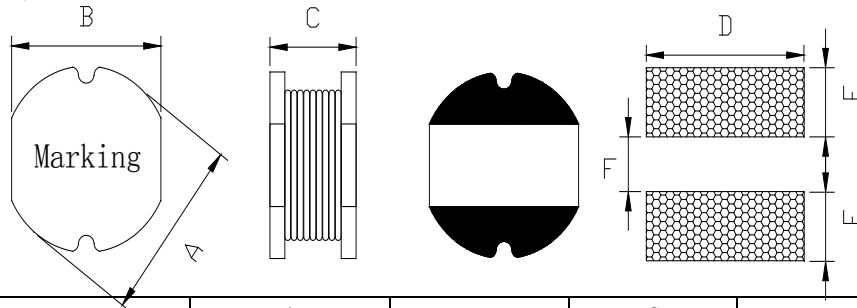

	A	B	C	D	E	F
JLCD0705	7.8 ± 0.3	7.0 ± 0.3	5.0 ± 0.5	7.50	3.00	2.00

电气特性 Electrical Characteristics

JL Part Number	Inductance (uH)	Tolerance ($\pm\%$)	DCR(Ω) MAX	Isat (A)	Irise (A)	Test Condition	Marking
JLCD0705-1R0N	1.0	30	0.013	3.40	3.40	100KHz /0.25V	1R0
JLCD0705-2R2N	2.2	30	0.023	3.00	3.00	100KHz /0.25V	2R2
JLCD0705-3R3M	3.3	20	0.028	2.80	2.80	100KHz /0.25V	3R3
JLCD0705-4R7M	4.7	20	0.045	2.70	2.70	100KHz /0.25V	4R7
JLCD0705-5R6M	5.6	20	0.048	2.65	2.65	100KHz /0.25V	5R6
JLCD0705-6R8M	6.8	20	0.058	2.50	2.50	100KHz /0.25V	6R8
JLCD0705-100M	10	20	0.070	2.30	2.30	1KHz /0.25V	100
JLCD0705-180M	18	20	0.100	1.60	1.60	1KHz /0.25V	180
JLCD0705-220M	22	20	0.110	1.50	1.50	1KHz /0.25V	220

JLCD0705-330M	33	20	0.130	1.20	1.20	1KHz /0.25V	330
JLCD0705-470M	47	20	0.180	1.40	1.40	1KHz /0.25V	470
JLCD0705-560M	56	20	0.240	0.94	0.94	1KHz /0.25V	560
JLCD0705-680M	68	20	0.280	0.85	0.85	1KHz /0.25V	680
JLCD0705-101M	100	20	0.430	0.72	0.72	1KHz /0.25V	101
JLCD0705-221M	220	20	0.960	0.49	0.49	1KHz /0.25V	221
JLCD0705-331M	330	20	1.260	0.40	0.40	1KHz /0.25V	331
JLCD0705-471M	470	20	1.960	0.34	0.34	1KHz /0.25V	471

1. Isat: DC current at which the inductance drops approximate 30% from its value without current;
2. Irms: DC current that causes the temperature rise ($\Delta T = 40^{\circ} C$) from $25^{\circ} C$ ambient.
3. Operating Temperature : $-40^{\circ} C \sim +105^{\circ} C$

JLCD 1004 系列

外部尺寸 External Dimensions Unit:mm

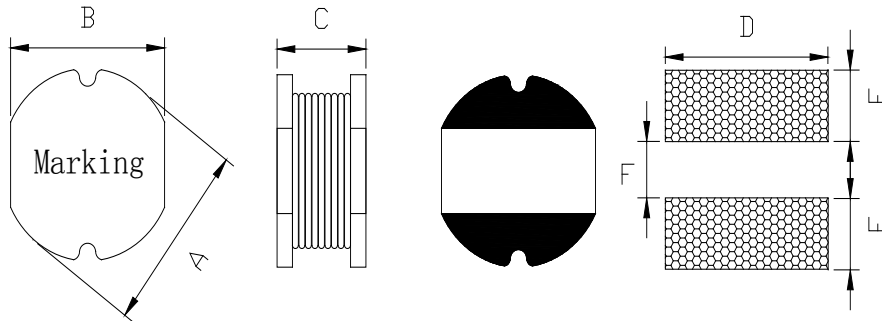

	A	B	C	D	E	F
JLCD1004	10.0 ± 0.4	9.0 ± 0.3	4.0 ± 0.5	9.50	3.75	2.50

电气特性 Electrical Characteristics

JL Part Number	Inductance (uH)	Tolerance ($\pm\%$)	DCR(Ω) MAX	Isat (A)	Irise (A)	Test Condition	Marking
JLCD1004-1R0N	1.0	30	0.012	8.70	8.70	100KHz /0.25V	1R0
JLCD1004-2R2N	2.2	30	0.020	5.40	5.40	100KHz /0.25V	2R2
JLCD1004-3R3M	3.3	20	0.028	2.85	2.85	100KHz /0.25V	3R3
JLCD1004-4R7M	4.7	20	0.038	2.75	2.75	100KHz /0.25V	4R7
JLCD1004-5R6M	5.6	20	0.040	2.70	2.70	100KHz /0.25V	5R6
JLCD1004-6R8M	6.8	20	0.042	2.65	2.65	100KHz /0.25V	6R8
JLCD1004-100N	10	20	0.053	2.38	2.38	1KHz /0.25V	100
JLCD1004-180N	18	20	0.081	1.73	1.73	1KHz /0.25V	180
JLCD1004-220N	22	20	0.090	1.60	1.60	1KHz /0.25V	220

JLCD1004-330N	33	20	0.120	1.26	1.26	1KHz /0.25V	330
JLCD1004-470N	47	20	0.170	1.10	1.10	1KHz /0.25V	470
JLCD1004-560N	56	20	0.199	1.01	1.01	1KHz /0.25V	560
JLCD1004-680N	68	20	0.223	0.91	0.91	1KHz /0.25V	680
JLCD1004-101N	100	20	0.344	0.74	0.74	1KHz /0.25V	101
JLCD1004-221N	220	20	0.721	0.53	0.53	1KHz /0.25V	221
JLCD1004-331N	330	20	1.100	0.42	0.42	1KHz /0.25V	331
JLCD1004-471N	470	20	1.526	0.35	0.35	1KHz /0.25V	471

1. Isat: DC current at which the inductance drops approximate 30% from its value without current;
2. Irms: DC current that causes the temperature rise ($\Delta T = 40^{\circ} C$) from $25^{\circ} C$ ambient.
3. Operating Temperature : $-40^{\circ} C \sim +105^{\circ} C$

JLCD 1005 系列

外部尺寸 External Dimensions Unit:mm

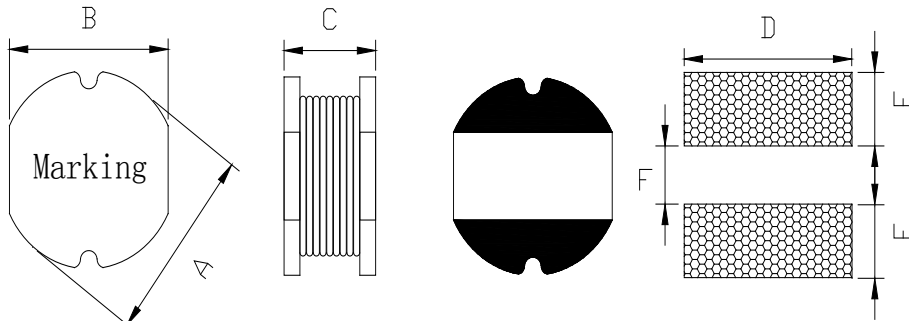

	A	B	C	D	E	F
JLCD1005	10.0±0.4	9.0±0.3	5.4±0.5	9.50	3.75	2.50

电气特性 Electrical Characteristics

JL Part Number	Inductance (uH)	Tolerance (±%)	DCR(Ω) MAX	Isat (A)	Irise (A)	Test Condition	Marking
JLCD1005-1R0N	1.0	30	0.014	6.8	6.80	100KHz /0.25V	1R0
JLCD1005-2R2N	2.2	30	0.014	6.80	6.80	100KHz /0.25V	2R2
JLCD1005-3R3M	3.3	20	0.018	3.05	3.05	100KHz /0.25V	3R3
JLCD1005-4R7M	4.7	20	0.020	2.90	2.90	100KHz /0.25V	4R7
JLCD1005-5R6M	5.6	20	0.04	2.75	2.75	100KHz /0.25V	5R6
JLCD1005-6R8M	6.8	20	0.040	2.75	2.75	100KHz /0.25V	6R8
JLCD1005-100N	10	20	0.060	2.60	2.60	1KHz /0.25V	100
JLCD1005-180N	18	20	0.090	2.15	2.15	1KHz /0.25V	180
JLCD1005-220N	22	20	0.100	1.95	1.95	1KHz /0.25V	220

JLCD1005-330N	33	20	0.120	1.50	1.50	1KHz /0.25V	330
JLCD1005-470N	47	20	0.170	1.28	1.28	1KHz /0.25V	470
JLCD1005-560N	56	20	0.190	1.17	1.17	1KHz /0.25V	560
JLCD1005-680N	68	20	0.220	1.11	1.11	1KHz /0.25V	680
JLCD1005-101N	100	20	0.350	0.97	0.97	1KHz /0.25V	101
JLCD1005-221N	220	20	0.730	0.66	0.66	1KHz /0.25V	221
JLCD1005-331N	330	20	1.150	0.52	0.52	1KHz /0.25V	331
JLCD1005-471N	470	20	1.480	0.42	0.42	1KHz /0.25V	471

1. Isat: DC current at which the inductance drops approximate 30% from its value without current;
2. Irms: DC current that causes the temperature rise ($\Delta T = 40^{\circ} C$) from $25^{\circ} C$ ambient.
3. Operating Temperature : $-40^{\circ} C \sim +105^{\circ} C$

JLCD 1006 系列

外部尺寸 External Dimensions Unit:mm

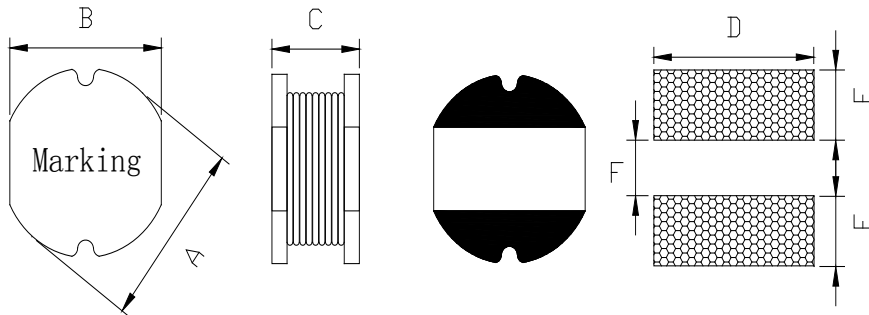

	A	B	C	D	E	F
JLCD1006	10.0 ± 0.4	9.0 ± 0.3	7.5 MAX	9.50	3.75	2.50

电气特性 Electrical Characteristics

JL Part Number	Inductance (uH)	Tolerance ($\pm\%$)	DCR(Ω) MAX	Isat (A)	Irise (A)	Test Condition	Marking
JLCD1006-1R0N	1.0	30	0.008	9.50	9.50	100KHz /0.25V	1R0
JLCD1006-2R2N	2.2	30	0.012	7.20	7.20	100KHz /0.25V	2R2
JLCD1006-3R3M	3.3	20	0.016	6.80	6.80	100KHz /0.25V	3R3
JLCD1006-4R7M	4.7	20	0.019	5.45	5.45	100KHz /0.25V	4R7
JLCD1006-5R6M	5.6	20	0.024	4.30	4.30	100KHz /0.25V	5R6
JLCD1006-6R8M	6.8	20	0.035	3.52	3.52	100KHz /0.25V	6R8
JLCD1006-100N	10	20	0.060	3.50	3.50	1KHz /0.25V	100
JLCD1006-180N	18	20	0.090	3.00	3.00	1KHz /0.25V	180
JLCD1006-220N	22	20	0.100	2.60	2.60	1KHz /0.25V	220

JLCD1006-330N	33	20	0.120	2.30	2.30	1KHz /0.25V	330
JLCD1006-470N	47	20	0.170	1.95	1.95	1KHz /0.25V	470
JLCD1006-560N	56	20	0.190	1.85	1.85	1KHz /0.25V	560
JLCD1006-680N	68	20	0.220	1.65	1.65	1KHz /0.25V	680
JLCD1006-101N	100	20	0.350	1.40	1.40	1KHz /0.25V	101
JLCD1006-221N	220	20	0.730	0.95	0.95	1KHz /0.25V	221
JLCD1006-331N	330	20	1.150	0.80	0.80	1KHz /0.25V	331
JLCD1006-471N	470	20	1.480	0.65	0.65	1KHz /0.25V	471

1. Isat: DC current at which the inductance drops approximate 30% from its value without current;
2. Irms: DC current that causes the temperature rise ($\Delta T = 40^{\circ} C$) from $25^{\circ} C$ ambient.
3. Operating Temperature : $-40^{\circ} C \sim +105^{\circ} C$

包装方式 PACKAGING SPECIFICATION :

Type	Quantity (Pcs/Reel)	Type	Quantity (Pcs/Reel)	Type	Quantity (Pcs/Reel)
JSHC2016	2000	JSHC0850	1000	JLCD0301	4000
JSHC2520	2000	JSHC1030	1000	JLCD0302	3000
JSHC0312	3000	JSHC1040	1000	JLCD0403	2000
JSHC0320	3000	JSHC1050	750	JLCD0502	3000
JSHC0412	3000	JSHC1060	700	JLCD0503	2000
JSHC0415	3000	JSHC1235	500	JLCD0504	1500
JSHC0418	3000	JSHC1250	500	JLCD0703	1000
JSHC0420	3000	JSHC1260	400	JLCD0705	1000
JSHC0512	2500	JSHC1265	400	JLCD1004	1000
JSHC0515	2500	JSHC1770	300	JLCD1005	1000
JSHC0518	2500			JLCD1006	1000
JSHC0520	2500	JLCR202610	2000		
JSHC0530	1500	JLCR252010	2000		
JSHC0540	1500	JLCR252012	2000		
JSHC0550	1500	JLCR3010	2000		

JSHC0560	1500		JLCR3012	2000		
JSHC0612	2000		JLCR3015	2000		
JSHC0615	2000		JLCR4010	4000		
JSHC0618	2000		JLCR4012	3000		
JSHC0620	2000		JLCR4018	3000		
JSHC0624	1500		JLCR4020	3000		
JSHC0630	1000		JLCR5020	3000		
JSHC0640	1000		JLCR5040	1500		
JSHC0650	1000		JLCR8040	1500		
JSHC0660	1000		JLCR6020	2500		
JSHC0830	1000		JLCR6028	2000		
JSHC0840	1000		JLCR6045	1500		

直插式电感

DIP Inductor

<http://www.cqjinlai.com>

工字系列 DR Inductor :

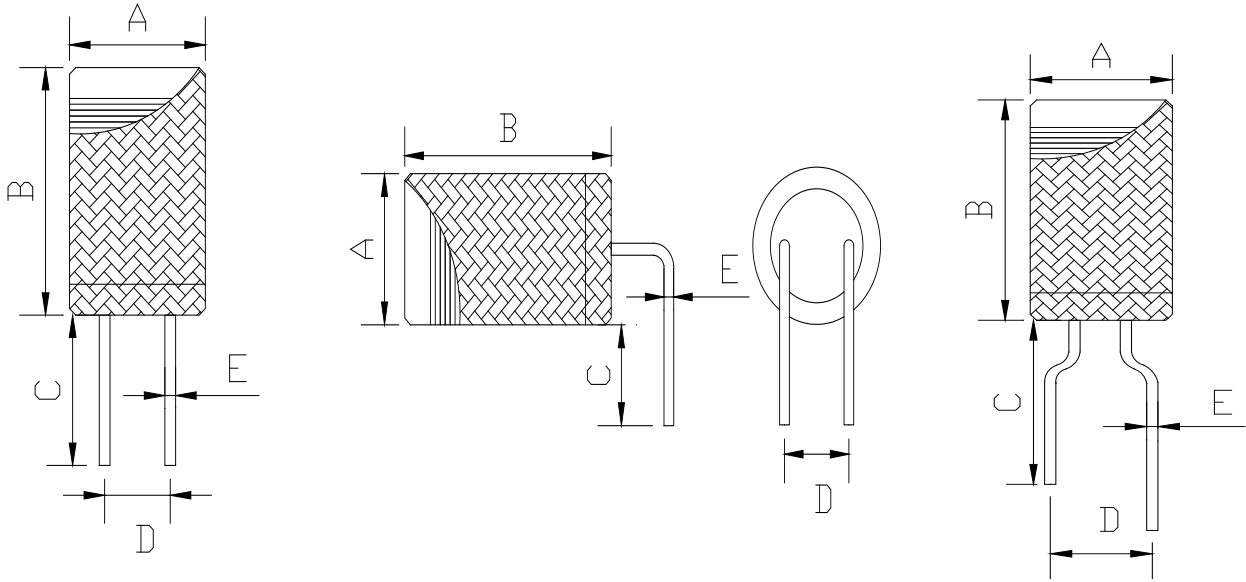

TYPE 1

TYPE 2

TYPE 3

MECHANICAL DIMENSION(UNIT:mm)

Size	A(max)	B(max)	C	D±0.5 Ref	E±0.1
JLDR0345	4.0	6.0	10~15	1.5	0.50
JLDR0406	5.0	9.0	10~15	2.0	0.55
JLDR0608	7.0	10.0	10~15	2.5	0.65
JLDR0810	9.0	12.0	10~15	5.0	0.65
JLDR0912	10.0	14.0	10~15	6.0	0.80
JLDR1012	11.0	14.0	10~15	6.0	0.80
JLDR1415	15.0	17.0	10~15	7.5	0.80
JLDR1618	17.0	20.0	10~15	12.5	1.0
JLDR1818	19.0	20.0	10~15	15.0	1.0

* 以上尺寸仅供参考，可以根据客户要求调整。

Reference value of the above dimensions, We can adjusted it according to your requirements.

磁屏蔽工字系列 DRP Shielding Inductor : :

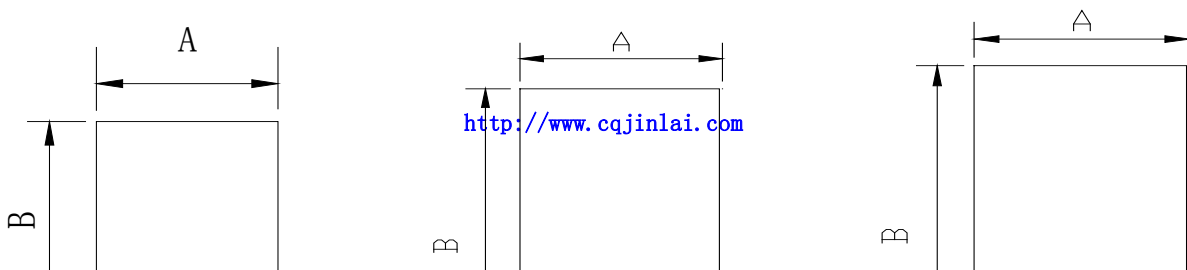

TYPE 1

TYPE 2

TYPE 3

MECHANICAL DIMENSION(UNIT:mm)

Size	A(max)	B(max)	C Ref	D±0.5 Ref	E±0.1
JLDRP0606	6.0	6.5	4.0	4.0	0.50
JLDRP1010	10.0	10.5	4.0	5.0	0.65
JLDRP1012	11.0	13.0	4.0	5.0	0.65
JLDRP1015	11.0	15.0	4.0	5.0	0.7
JLDRP1215	12.8	15.0	4.0	5.0	0.7
JLDRP1317	13.5	18.5	4.0	5.0	0.70
JLDRP1619	18.0	27.0	4.0	10.5	1.00

* 以上尺寸仅供参考，可以根据客户要求调整。

Reference value of the above dimensions, We can adjusted it according to your requirements.

R 型系列 R Inductor :

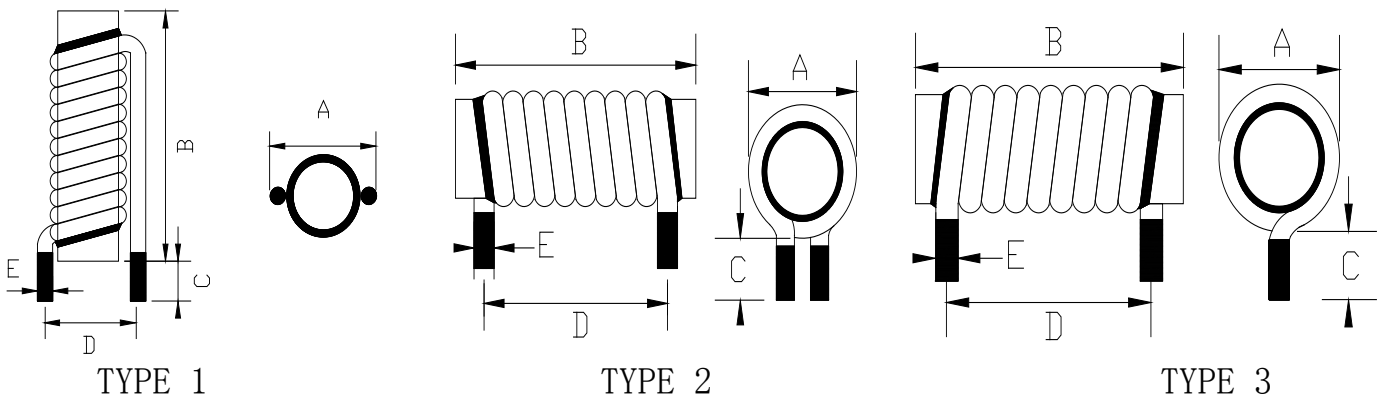

MECHANICAL DIMENSION(UNIT:mm)

Iron powder core series	A(Ref)	B(Ref)	C Ref	D±0.5 Ref	
JLR1.0x6.5	1.0	6.5	Ref	Ref	

JLR1. 2x4. 5	1. 2	4. 5	Ref	Ref	
JLR1. 5x5. 0	1. 5	5. 0	Ref	Ref	
JLR1. 9x6. 5	1. 9	6. 5	Ref	Ref	
JLR1. 2x4. 8	1. 2	4. 8	Ref	Ref	
JLR2. 0x12. 0	2. 0	12. 0	Ref	Ref	
JLR2. 6x20. 0	2. 6	20. 0	Ref	Ref	
JLR3. 0x15. 0	3. 0	15. 0	Ref	Ref	
JLR3. 0x25. 0	3. 0	25. 0	Ref	Ref	
JLR3. 5x25. 0	3. 5	25. 0	Ref	Ref	
JLR4. 0x10. 0	4. 0	10. 0	Ref	Ref	
JLR4. 0x12. 0	4. 0	12. 0	Ref	Ref	
JLR4. 0x15. 0	4. 0	15. 0	Ref	Ref	
JLR4. 0x20. 0	4. 0	20. 0	Ref	Ref	
JLR5. 0x20. 0	5. 0	20. 0	Ref	Ref	
JLR5. 0x25. 0	5. 0	25. 0	Ref	Ref	
JLR6. 0x15. 0	6. 0	15. 0	Ref	Ref	
JLR6. 0x20. 0	6. 0	20. 0	Ref	Ref	
JLR6. 0x25. 0	6. 0	25. 0	Ref	Ref	
JLR8. 0x10. 0	8. 0	10. 0	Ref	Ref	
JLR8. 0x30. 0	8. 0	30. 0	Ref	Ref	
JLR10. 0x30. 0	10. 0	30. 0	Ref	Ref	

* A, B 尺寸为磁芯尺寸，以上尺寸仅供参考，可以根据客户要求调整。

The size of A and B is only from the core.,Reference value of the above dimensions, We can adjusted it according to your requirements.

T 型系列 T Inductor :

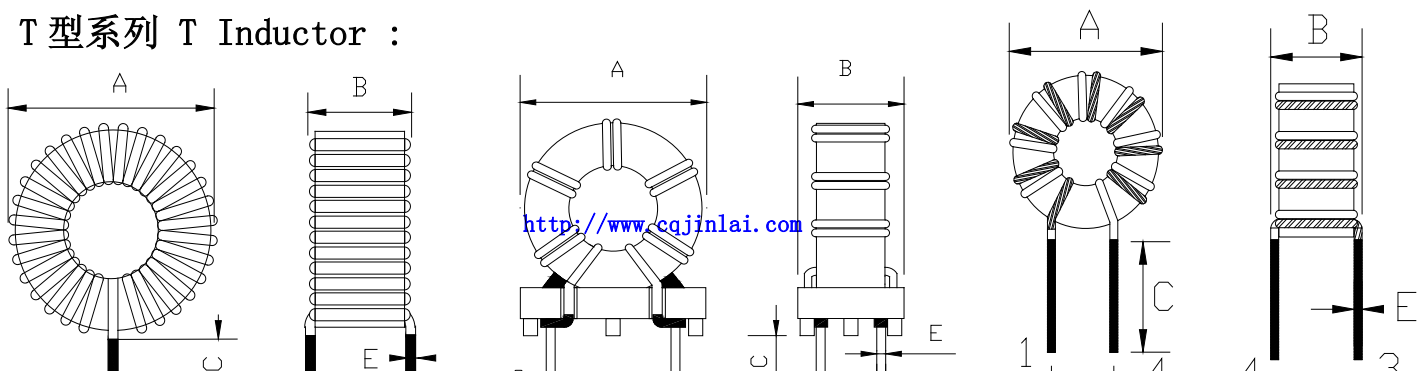

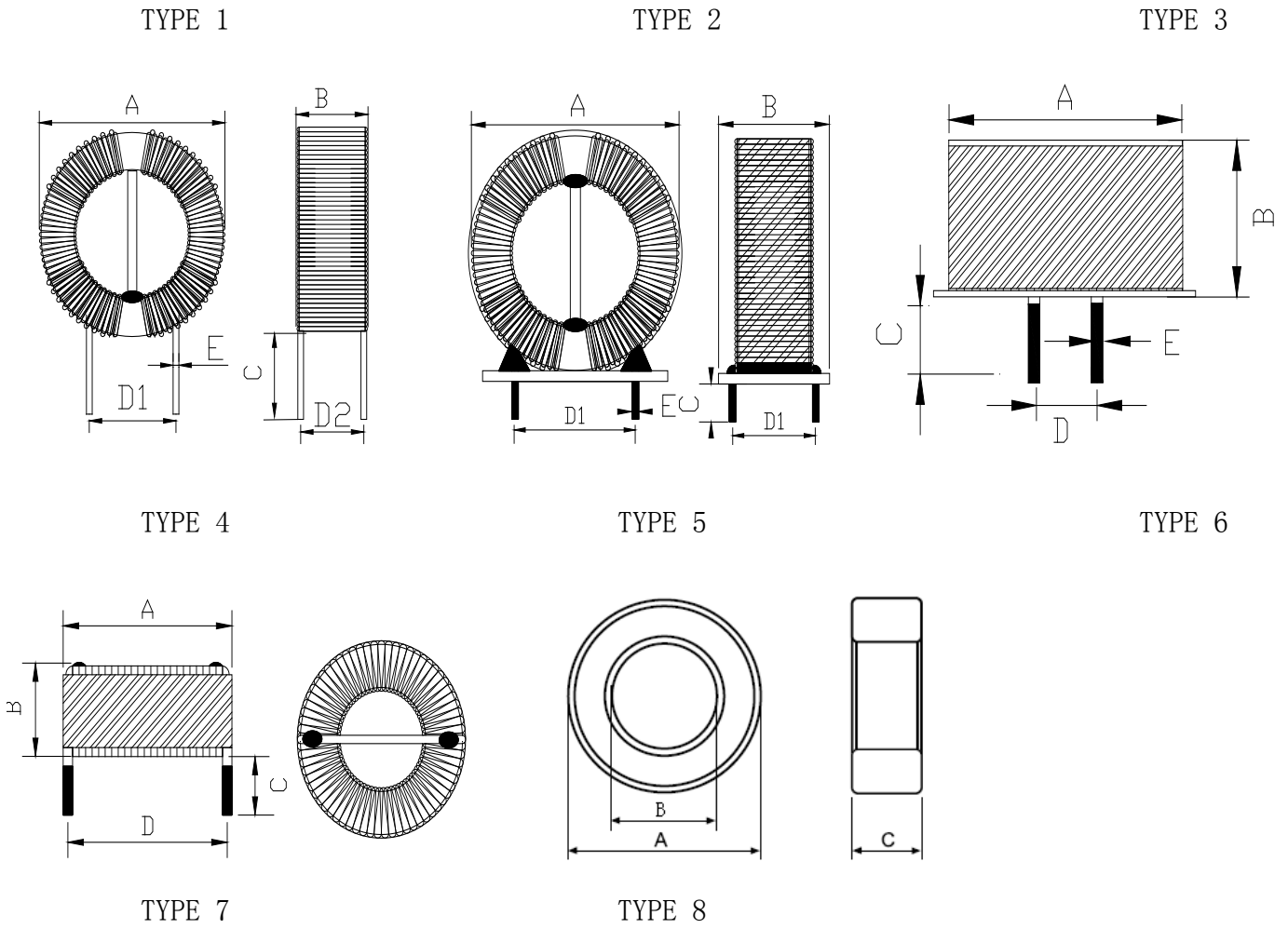

MECHANICAL DIMENSION (UNIT:mm)

1 铁粉芯 Iron powder core series

Iron powder core series	material	A * B * C (TYPE 8)
T30	2, 8, 18, 26, 40, 52	7.8*3.84*3.25

T37	2, 8, 18, 26, 40, 52	9.53*5.21*3.25
T38	2, 8, 18, 26, 40, 52	9.53*4.45*4.83
T44	2, 8, 18, 26, 40, 52	11.2*5.82*4.04
T50	2, 8, 18, 26, 40, 52	12.7*7.7*4.83
T60	2, 8, 18, 26, 40, 52	15.2*8.53*5.94
T68	2, 8, 18, 26, 40, 52	17.5*9.4*4.83
T68-A	2, 8, 18, 26, 40, 52	17.5*9.4*4.83
T68-D	2, 8, 18, 26, 40, 52	17.5*9.4*4.83
T72	2, 8, 18, 26, 40, 52	18.3*7.11*6.6
T80	2, 8, 18, 26, 40, 52	20.2*12.6*6.35
T94	2, 8, 18, 26, 40, 52	23.9*14.2*7.92
T106	2, 8, 18, 26, 40, 52	26.9*14.5*11.1
T130	2, 8, 18, 26, 40, 52	33.0*19.8*11.1
T157	2, 8, 18, 26, 40, 52	39.9*24.1*14.5
T175	2, 8, 18, 26, 40, 52	44.5*27.2*16.5
T184	2, 8, 18, 26, 40, 52	46.7*24.1*18.0
T200	2, 8, 18, 26, 40, 52	50.8*31.8*14.0
T225	2, 8, 18, 26, 40, 52	57.2*35.7*14.0

2 锰锌铁氧体 Ferrite core series

Ferrite core series	material	A * B * C (TYPE 8)
T2.5x1.5x1.3	Mn-Zn	2.5x1.5x1.3
.....		A : 2.5mm~85.7mm B : 1.5mm~55.5mm C : 1.3mm~17.2mm
Detailed specifications, please call Advisory		
T85.7x55.5x17.2		85.7x55.5x17.2

3 铁硅铝 Sendust core

Sendust core	material	A * B * C (TYPE 8)
.....	Sendust	3.56x1.78x1.52
Detailed specifications, please call Advisory		A : 3.56mm~77.8mm B : 1.78mm~49.23mm C : 1.52mm~12.7mm
		77.8x49.23x12.7

The Core specifications and specific materials, please telephone consultation.

滤波器系列 Wave filter inductor :

1 UU Wave filter

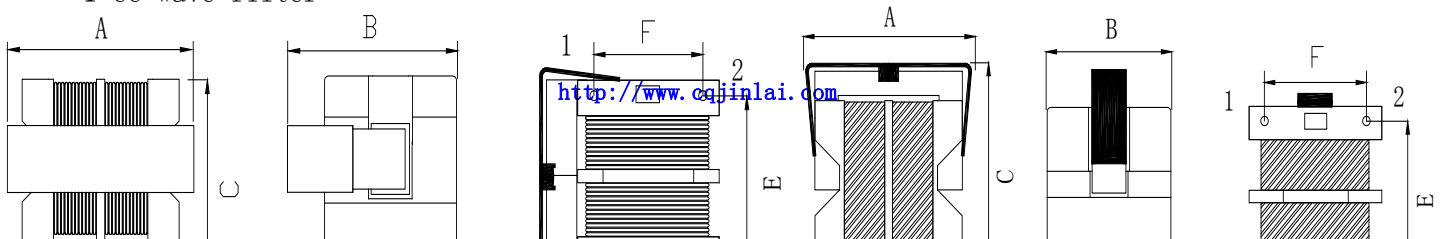

TYPE 1

TYPE 2

MECHANICAL DIMENSION(UNIT:mm)

Specifications	A	B	C	D	E	F	Notes
UU9.8	17.5 Max	12.5 Max	17.5 Max	3.5±0.5	8.0±0.5	7.0±0.5	TYPE 2
UU9.8	17.5 Max	16.5 Max	13.5 Max	3.5±0.5	8.0±0.5	7.0±0.5	TYPE 1
UU10.5	19.5 Max	17.5 Max	22.5 Max	3.5±0.5	13.0±0.5	10.0±0.5	TYPE 2
UU10.5	19.5 Max	21.5 Max	17.5 Max	3.5±0.5	13.0±0.5	10.0±0.5	TYPE 1
UU16	24.5 Max	19.5 Max	27.5 Max	3.5±0.5	13.0±0.5	10.0±0.5	TYPE 2
UU16	24.5 Max	25.5 Max	23.5 Max	3.5±0.5	13.0±0.5	10.0±0.5	TYPE 1

2 ET Wave filter

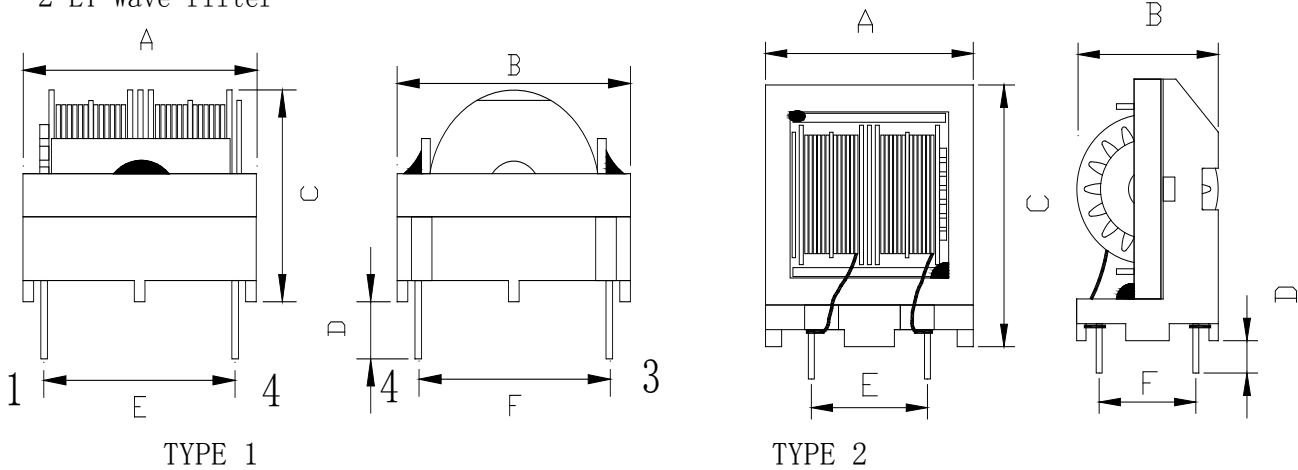

Specifications	A	B	C	D	E	F	Notes
ET24	26.5 Max	19.5 Max	31.5 Max	3.5±0.5	13.0±0.5	10.0±0.5	TYPE 2
ET24	25.5 Max	25.5 Max	21.5 Max	3.5±0.5	15.0±0.5	20.0±0.5	TYPE 1
ET28	25.5 Max	22.5 Max	36.5 Max	3.5±0.5	13.0±0.5	10.0±0.5	TYPE 2
ET28	30.5 Max	30.5 Max	25.5 Max	3.5±0.5	24.0±0.5	20.0±0.5	TYPE 1
ET35	38.5 Max	27.5 Max	45.5 Max	3.5±0.5	21.0±0.5	15.0±0.5	TYPE 2
ET35	38.0 Max	38.0 Max	29.0 Max	3.5±0.5	30.0±0.5	25.0±0.5	TYPE 1

高频变压器

HF Transformer

EE8.3/EE10 系列 EE8.3/EE10 Transformer:

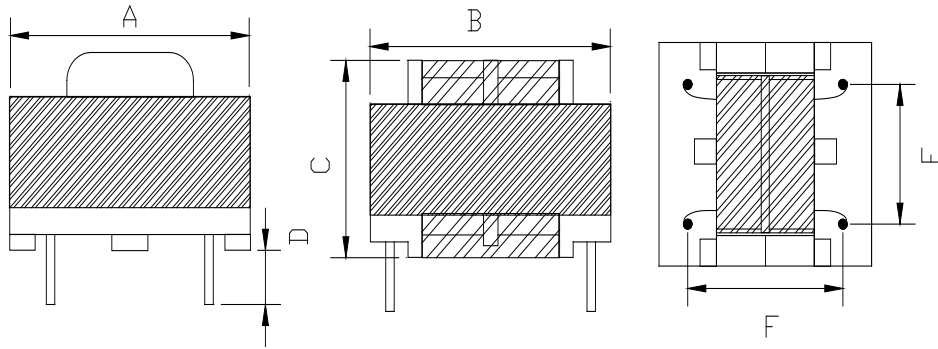

MECHANICAL DIMENSION(UNIT:mm)

Specifications	A	B	C	D	E	F	Notes
EE8.3	9.5 Max	9.5 Max	9.5 Max	4.0±0.5	5.0±0.5	6.75±0.5	
EE10	11.5 Max	12.5 Max	11.5 Max	4.0±0.5	5.0±0.5	8.9±0.5	

EE13 型系列 Transformer:

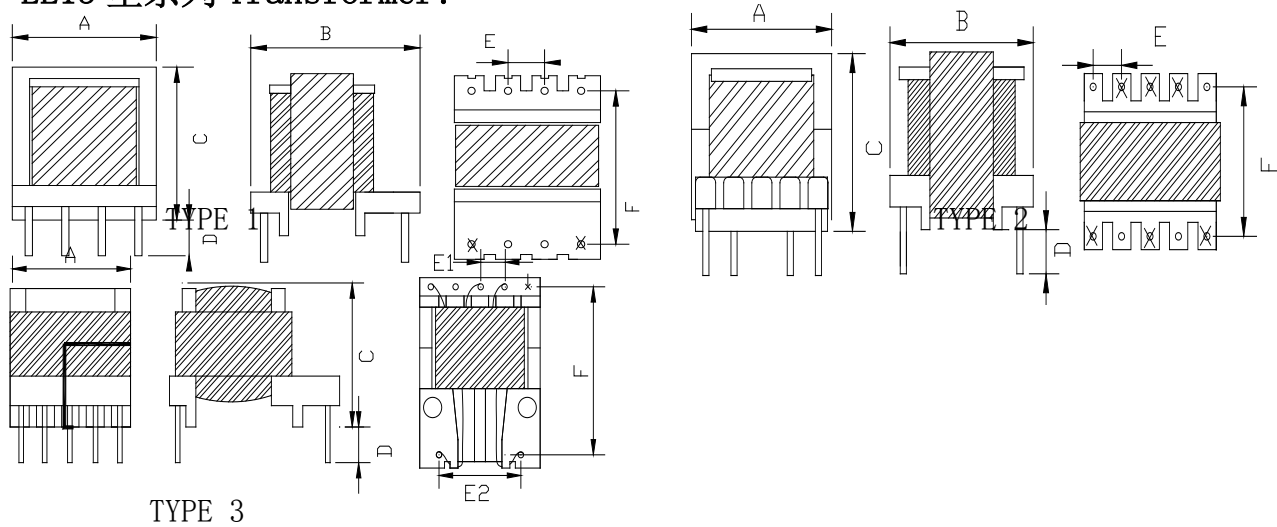

MECHANICAL DIMENSION(UNIT:mm)

Specifications	A	B	C	D	E	F	Notes
EE13	14.0 Max	17.5 Max	15.0 Max	4.0 Ref	3.5±0.5	13.0±0.5	TYPE 1
EE13	14.0 Max	12.5 Max	14.5 Max	4.0 Ref	2.5±0.5	9.0±0.5	TYPE 2
EE13	14.0 Max	21.0 Max	14.5 Max	4.0 Ref	2.75±0.5 9.0±0.5	16.0±0.5	TYPE 3

EE16 系列 EE16 Transformer:

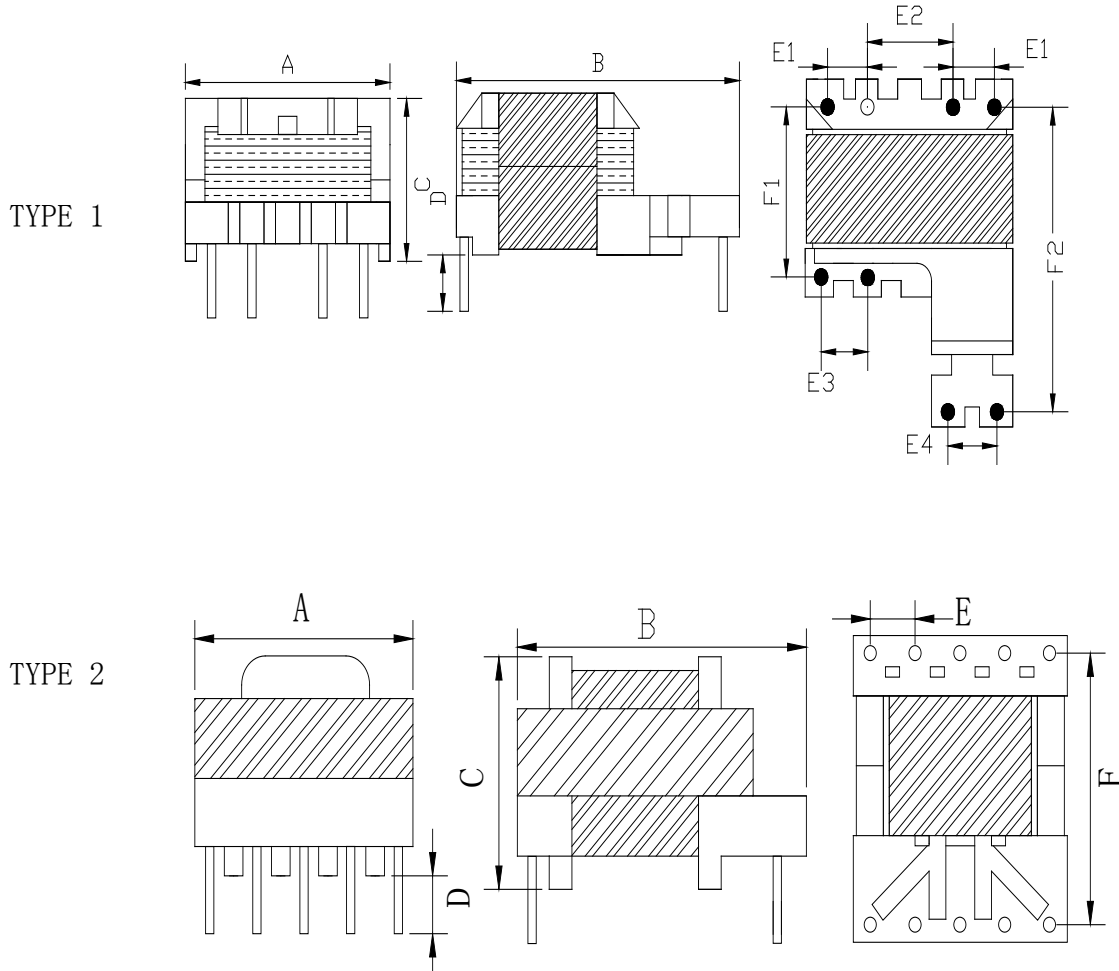

MECHANICAL DIMENSION(UNIT:mm)

Specifications	A	B	C	D	E	F	Notes
EE16	18.0 Max	25.0 Max	13.0 Max	4.0 Ref	E1 3.3±0.5 E2 5.4±0.5 E1 2.9±0.5 E1 3.2±0.5	F1 12.0±0.5 F1 20.0±0.5	TYPE 1
EE16	17.0 Max	22.5 Max	14.0 Max	4.0 Ref	3.2±0.5	15.8±0.5	TYPE 2

EE19 系列 EE19 Transformer:

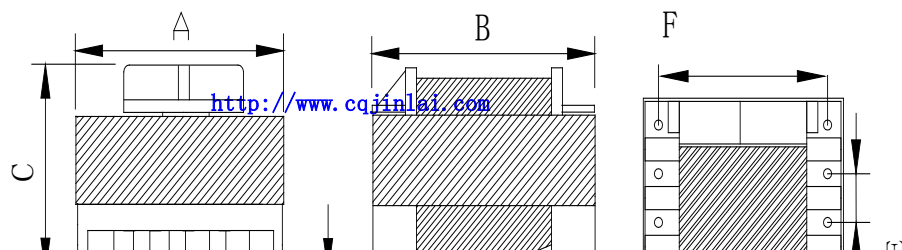

TYPE 1

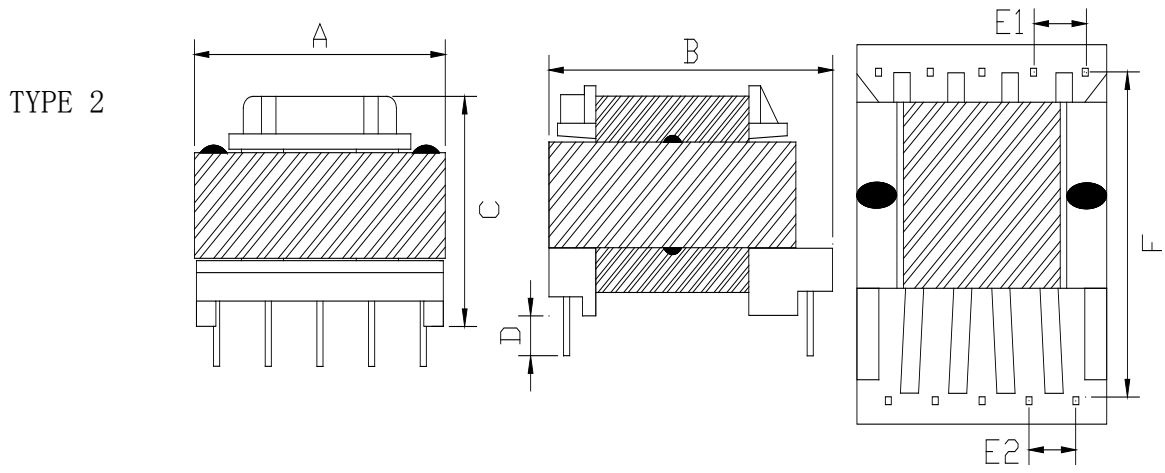

MECHANICAL DIMENSION(UNIT:mm)

Specifications	A	B	C	D	E	F	Notes
EE19	20.5 Max	19.5 Max	16.5 Max	4.0 Ref	3.0±0.5	12.5±0.5	TYPE 1
EE19	25.0 Max	40.0 Max	18.5 Max	4.0 Ref	E1 5.0±0.5 E2 4.5±0.5	32.5±0.5	TYPE 2

POT33 系列 POT33 Transformer:

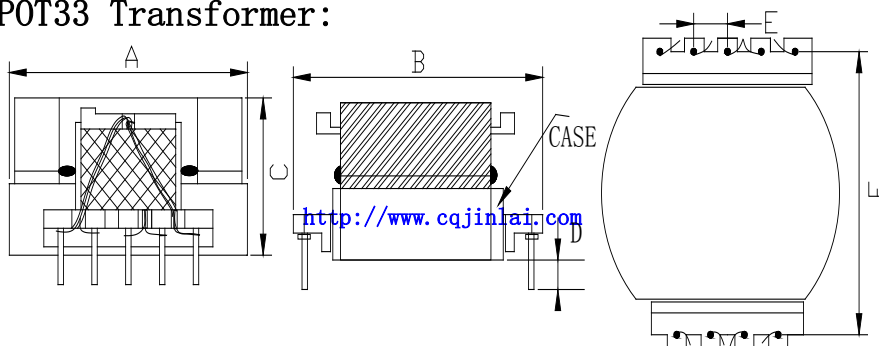

MECHANICAL DIMENSION(UNIT:mm)

Specifications	A	B	C	D	E	F	Notes
EE19	36.5 Max	39.5 Max	20.0 Max	4.0 Ref	5.0±0.5	33.5±0.5	

ETD 系列 ETD Transformer:

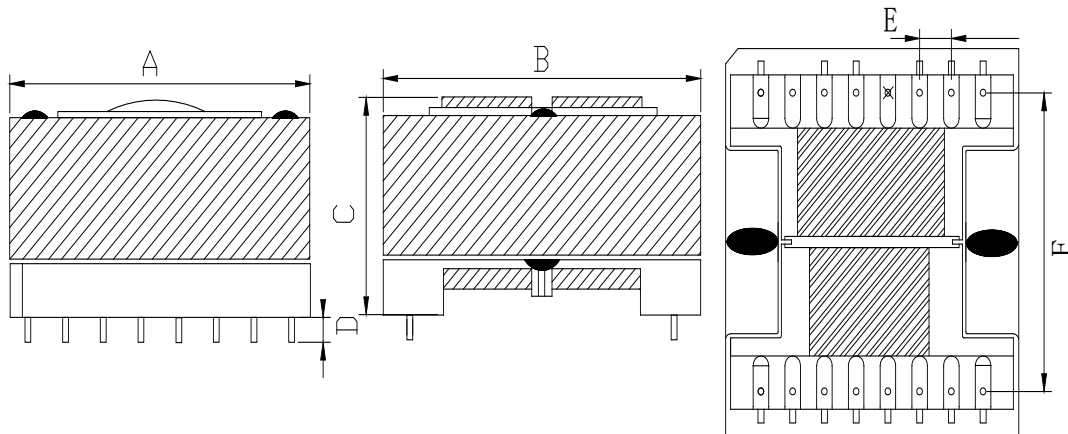

MECHANICAL DIMENSION(UNIT:mm)

Specifications	A	B	C	D	E	F	Notes
ETD44	46.0 Max	50.0 Max	29.5 Max	4.0 Ref	5.0±0.5	35.0±0.5	
ETD49	53.0 Max	56.0 Max	38.0 Max	4.0 Ref	5.5±0.5	44.8±0.5	

* 以上尺寸仅供参考，可以根据客户要求调整。

Reference value of the above dimensions, We can adjusted it according to your requirements.

重庆金籁科技股份有限公司

传真：023-81850171

全国服务热线：400-114-9558

地址：重庆市丰都县水天坪工业园区

网址：<http://www.cqjinlai.com>



X-ON Electronics

Largest Supplier of Electrical and Electronic Components

Click to view similar products for [Fixed Inductors](#) category:

Click to view products by [Jinlai](#) manufacturer:

Other Similar products are found below :

[MLZ1608M6R8WTD25](#) [MLZ1608N6R8LT000](#) [MLZ1608N3R3LTD25](#) [MLZ1608N3R3LT000](#) [MLZ1608N150LT000](#)
[MLZ1608M150WTD25](#) [MLZ1608M3R3WTD25](#) [MLZ1608M3R3WT000](#) [MLZ1608M150WT000](#) [MLZ1608A1R5WT000](#)
[MLZ1608N1R5LT000](#) [B82432C1333K000](#) [PCMB053T-1R0MS](#) [PCMB053T-1R5MS](#) [PCMB104T-1R5MS](#) [CR32NP-100KC](#) [CR32NP-151KC](#) [CR32NP-180KC](#) [CR32NP-181KC](#) [CR32NP-1R5MC](#) [CR32NP-390KC](#) [CR32NP-3R9MC](#) [CR32NP-680KC](#) [CR32NP-820KC](#)
[CR32NP-8R2MC](#) [CR43NP-390KC](#) [CR43NP-560KC](#) [CR43NP-680KC](#) [CR54NP-181KC](#) [CR54NP-470LC](#) [CR54NP-820KC](#) [CR54NP-8R5MC](#)
[MGDQ4-00004-P](#) [MGDU1-00016-P](#) [MHL1ECTTP18NJ](#) [MHL1JCTTD12NJ](#) [PE-51506NL](#) [PE-53601NL](#) [PE-53630NL](#) [PE-53824SNLT](#) [PE-62892NL](#) [PE-92100NL](#) [PG0434.801NLT](#) [PG0936.113NLT](#) [PM06-2N7](#) [PM06-39NJ](#) [HC2LP-R47-R](#) [HC2-R47-R](#) [HC3-2R2-R](#) [HC8-1R2-R](#)