

GENERAL DESCRIPTION

The SGM3110 is a Micro-Power switched capacitor voltage converter that delivers a regulated output. No external inductor is required for operation.

The SGM3110 can deliver up to 100mA to the voltage regulated output. It features very low quiescent current and high efficiency over a large portion of its load range, making this device ideal for battery-powered applications. Furthermore, the combination of few external components and small package size keeps the total converter board area to a minimum in space-restricted applications.

The SGM3110 uses a pulse skipping technique to provide a regulated output from a varying input supply. The SGM3110 contains a thermal management circuit to protect the device under continuous output short-circuit conditions.

The SGM3110 is available in Green SOT-23-6 package and is rated over the -40°C to +85°C temperature range.

FEATURES

- **Step-Up Voltage Converter**
- **Input Voltage Range:**
 SGM3110-5.0: 2.7V to 5.0V
 SGM3110-4.5: 2.7V to 4.5V
- **Micro-Power Consumption: 60µA**
- **4.5V and 5V Regulated ±4% Output Voltages**
- **250mA Peak Current for 100ms**
- **High Frequency 750kHz Operation**
- **Logic-Controlled Shutdown**
- **Short-Circuit and Over-Temperature Protections**
- **Available in Green SOT-23-6 Package**

APPLICATIONS

- Cellular Phones
- Digital Cameras
- Handheld Electronics
- LED/Display Backlight Driver
- LEDs for Camera Flash
- Portable Communication Devices
- MP3 Players
- GPS Receivers
- PDA's

TYPICAL APPLICATION

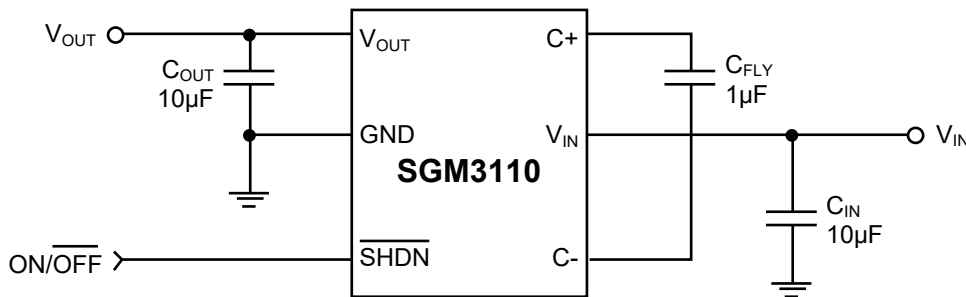

PACKAGE/ORDERING INFORMATION

MODEL	PACKAGE DESCRIPTION	SPECIFIED TEMPERATURE RANGE	ORDERING NUMBER	PACKAGE MARKING	PACKING OPTION
SGM3110-4.5	SOT-23-6	-40°C to +85°C	SGM3110-4.5YN6/TR	3110A	Tape and Reel, 3000
SGM3110-5.0	SOT-23-6	-40°C to +85°C	SGM3110-5.0YN6/TR	3110	Tape and Reel, 3000

Green (RoHS & HSF): SG Micro Corp defines "Green" to mean Pb-Free (RoHS compatible) and free of halogen substances. If you have additional comments or questions, please contact your SGMICRO representative directly.

ABSOLUTE MAXIMUM RATINGS

V_{IN} to GND	-0.3V to 6V
V_{OUT} to GND	-0.3V to 6V
\overline{SHDN} to GND	-0.3V to 6V
Power Dissipation, P_D @ $T_A = +25^\circ\text{C}$	
SOT-23-6	0.34W
Package Thermal Resistance	
SOT-23-6, θ_{JA}	250°C/W
Junction Temperature	+150°C
Storage Temperature Range	-65°C to +150°C
Lead Temperature (Soldering, 10s)	+260°C
ESD Susceptibility	
HBM	2000V
MM	400V

RECOMMENDED OPERATING CONDITIONS

Operating Temperature Range	-40°C to +85°C
-----------------------------------	----------------

OVERSTRESS CAUTION

Stresses beyond those listed may cause permanent damage to the device. Functional operation of the device at these or any other conditions beyond those indicated in the operational section of the specification is not implied. Exposure to absolute maximum rating conditions for extended periods may affect reliability.

ESD SENSITIVITY CAUTION

This integrated circuit can be damaged by ESD if you don't pay attention to ESD protection. SGMICRO recommends that all integrated circuits be handled with appropriate precautions. Failure to observe proper handling and installation procedures can cause damage. ESD damage can range from subtle performance degradation to complete device failure. Precision integrated circuits may be more susceptible to damage because very small parametric changes could cause the device not to meet its published specifications.

DISCLAIMER

SG Micro Corp reserves the right to make any change in circuit design, specification or other related things if necessary without notice at any time.

PIN CONFIGURATION

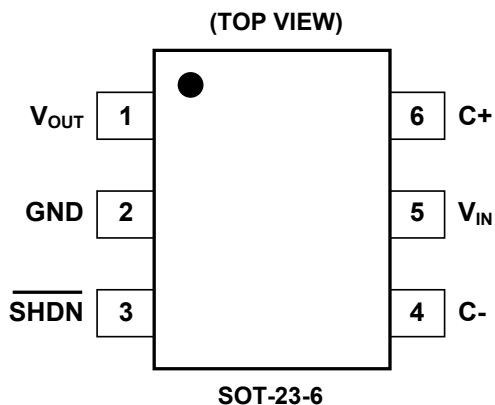

PIN DESCRIPTION

PIN	NAME	FUNCTION
1	V _{OUT}	Regulated Output Pin.
2	GND	Ground.
3	SHDN	Shutdown Input. Logic low signal disables the converter.
4	C-	Flying Capacitor Negative Terminal.
5	V _{IN}	Input Supply Pin.
6	C+	Flying Capacitor Positive Terminal.

FUNCTIONAL BLOCK DIAGRAM

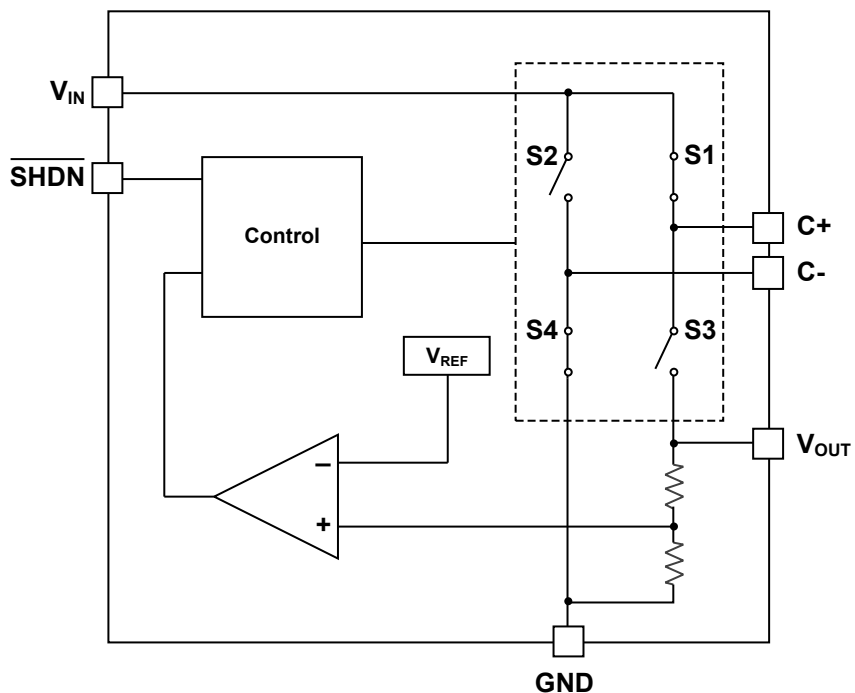

ELECTRICAL CHARACTERISTICS

(At $T_A = -40^\circ\text{C}$ to $+85^\circ\text{C}$, $C_{FLY} = 1\mu\text{F}$, $C_{IN} = 10\mu\text{F}$ and $C_{OUT} = 10\mu\text{F}$. Typical values are at $T_A = +25^\circ\text{C}$, unless otherwise noted.)

PARAMETER	SYMBOL	CONDITIONS	MIN	TYP	MAX	UNITS
SGM3110-5.0						
Input Voltage Range	V_{IN}	$V_{OUT} = 5.0\text{V}$	2.7		V_{OUT}	V
Output Voltage	V_{OUT}	$2.7\text{V} < V_{IN} < 5\text{V}$, $I_{OUT} \leq 50\text{mA}$	4.8	5.0	5.2	V
		$3.0\text{V} < V_{IN} < 5\text{V}$, $I_{OUT} \leq 100\text{mA}$	4.8	5.0	5.2	
Quiescent Power Supply Current	I_Q	$2.7\text{V} < V_{IN} < 5\text{V}$, $I_{OUT} = 0\text{mA}$, $\overline{\text{SHDN}} = V_{IN}$		60	68	μA
Shutdown Supply Current	I_{SHDN}	$2.7\text{V} < V_{IN} < 3.6\text{V}$, $I_{OUT} = 0\text{mA}$, $V_{SHDN} = 0$		0.2	1	μA
		$3.6\text{V} < V_{IN} < 5\text{V}$, $I_{OUT} = 0\text{mA}$, $V_{SHDN} = 0$			1	
Ripple Voltage	V_{RIPPLE}	$V_{IN} = 2.7\text{V}$, $I_{OUT} = 50\text{mA}$		15		mV_{P-P}
		$V_{IN} = 3\text{V}$, $I_{OUT} = 100\text{mA}$		88		
Efficiency	η	$V_{IN} = 2.7\text{V}$, $I_{OUT} = 50\text{mA}$		91		%
Frequency	f_{OSC}	Oscillator Free Running		750		kHz
$\overline{\text{SHDN}}$ Input Threshold High	V_{IH}		1.4			V
$\overline{\text{SHDN}}$ Input Threshold Low	V_{IL}				0.4	
$\overline{\text{SHDN}}$ Input High Current	I_{IH}	$\overline{\text{SHDN}} = V_{IN}$	-1		+1	μA
$\overline{\text{SHDN}}$ Input Low Current	I_{IL}	$\overline{\text{SHDN}} = \text{GND}$	-1		+1	μA
Turn-On Time	t_{ON}	$V_{IN} = 3\text{V}$, $I_{OUT} = 0\text{mA}$		0.3		ms
SGM3110-4.5						
Input Voltage Range	V_{IN}	$V_{OUT} = 4.5\text{V}$	2.7		V_{OUT}	V
Output Voltage	V_{OUT}	$2.7\text{V} < V_{IN} < 4.5\text{V}$, $I_{OUT} \leq 50\text{mA}$	4.32	4.5	4.68	V
		$3.0\text{V} < V_{IN} < 4.5\text{V}$, $I_{OUT} \leq 100\text{mA}$	4.32	4.5	4.68	
Quiescent Power Supply Current	I_Q	$2.7\text{V} < V_{IN} < 4.5\text{V}$, $I_{OUT} = 0\text{mA}$, $\overline{\text{SHDN}} = V_{IN}$		60	68	μA
Shutdown Supply Current	I_{SHDN}	$2.7\text{V} < V_{IN} < 3.6\text{V}$, $I_{OUT} = 0\text{mA}$, $V_{SHDN} = 0$		0.2	1	μA
		$3.6\text{V} < V_{IN} < 4.5\text{V}$, $I_{OUT} = 0\text{mA}$, $V_{SHDN} = 0$			1	
Ripple Voltage	V_{RIPPLE}	$V_{IN} = 2.7\text{V}$, $I_{OUT} = 50\text{mA}$		15		mV_{P-P}
		$V_{IN} = 3\text{V}$, $I_{OUT} = 100\text{mA}$		88		
Efficiency	η	$V_{IN} = 2.7\text{V}$, $I_{OUT} = 50\text{mA}$		83		%
Frequency	f_{OSC}	Oscillator Free Running		750		kHz
$\overline{\text{SHDN}}$ Input Threshold High	V_{IH}		1.4			V
$\overline{\text{SHDN}}$ Input Threshold Low	V_{IL}				0.4	
$\overline{\text{SHDN}}$ Input High Current	I_{IH}	$\overline{\text{SHDN}} = V_{IN}$	-1		+1	μA
$\overline{\text{SHDN}}$ Input Low Current	I_{IL}	$\overline{\text{SHDN}} = \text{GND}$	-1		+1	μA
Turn-On Time	t_{ON}	$V_{IN} = 3\text{V}$, $I_{OUT} = 0\text{mA}$		0.3		ms

TYPICAL PERFORMANCE CHARACTERISTICS

At $T_A = +25^\circ\text{C}$, $V_S = 5\text{V}$, $V_{IN} = 3\text{V}$, $C_{IN} = C_{OUT} = 10\mu\text{F}$ and $C_{FLY} = 1\mu\text{F}$, unless otherwise noted.

Startup Time with 50mA Load

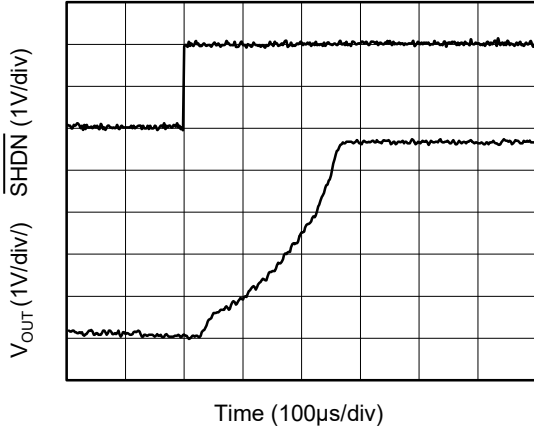

Startup Time with 100mA Load

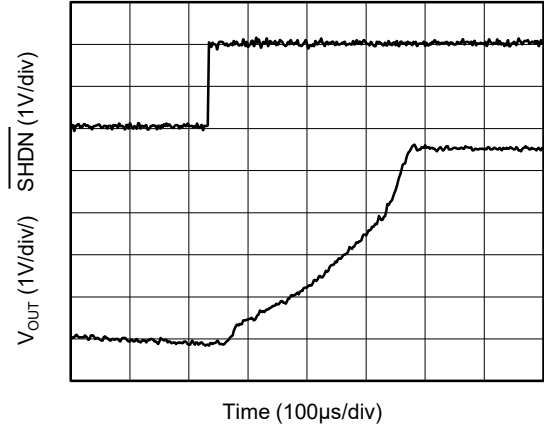

Output Ripple with $I_{OUT} = 50\text{mA}$

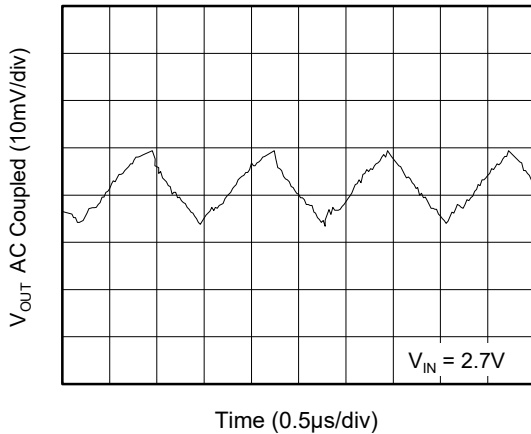

Output Ripple with $I_{OUT} = 100\text{mA}$

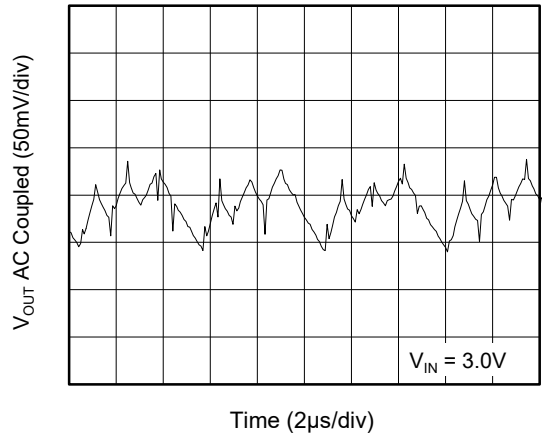

Load Transient Response for 50mA

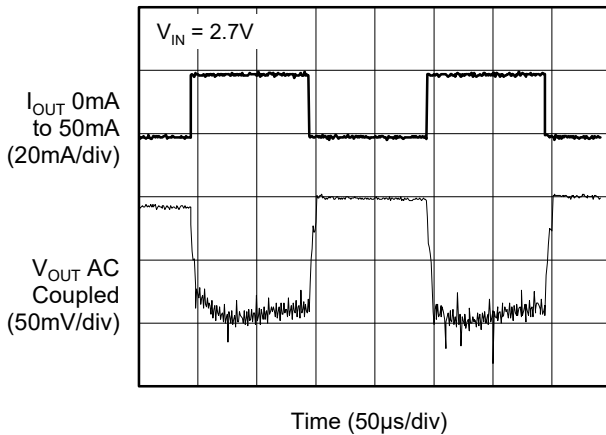

Load Transient Response for 100mA

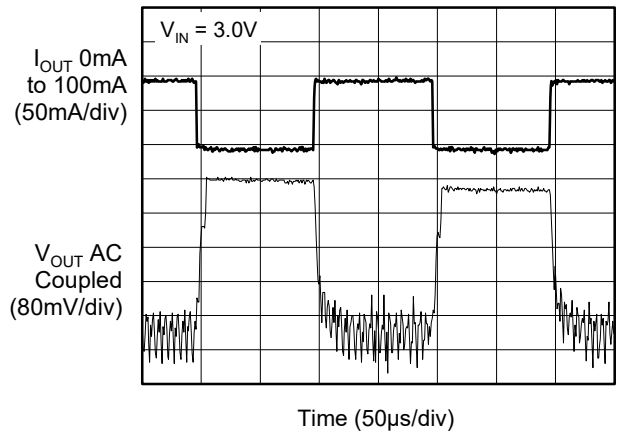

TYPICAL PERFORMANCE CHARACTERISTICS (continued)

At $T_A = +25^\circ\text{C}$, $V_S = 5\text{V}$, $V_{IN} = 3\text{V}$, $C_{IN} = C_{OUT} = 10\mu\text{F}$ and $C_{FLY} = 1\mu\text{F}$, unless otherwise noted.

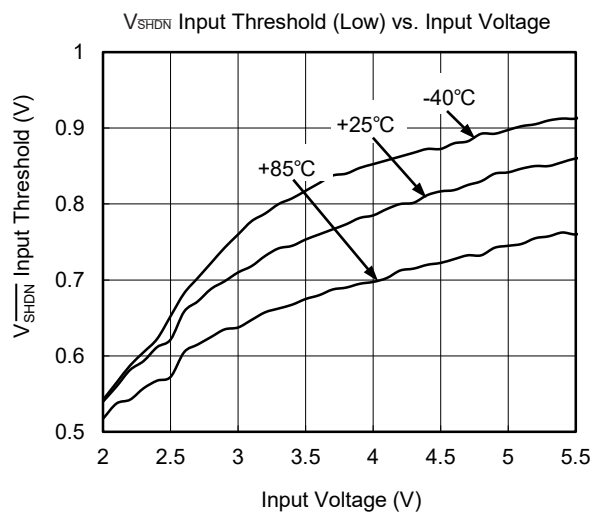
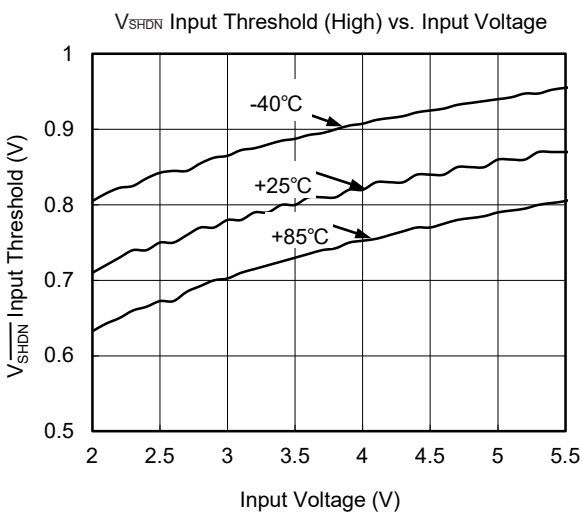
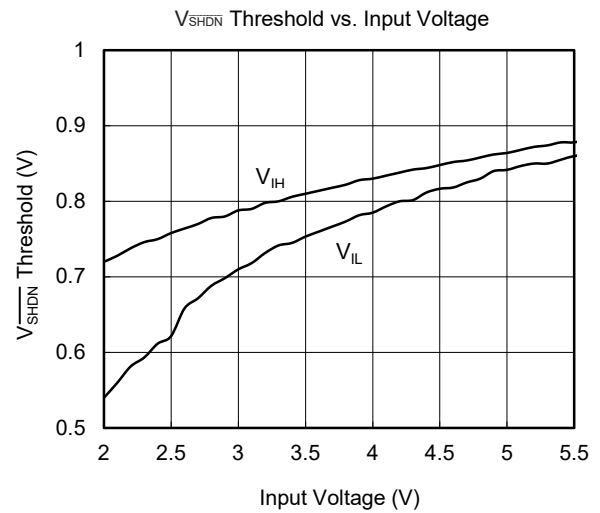
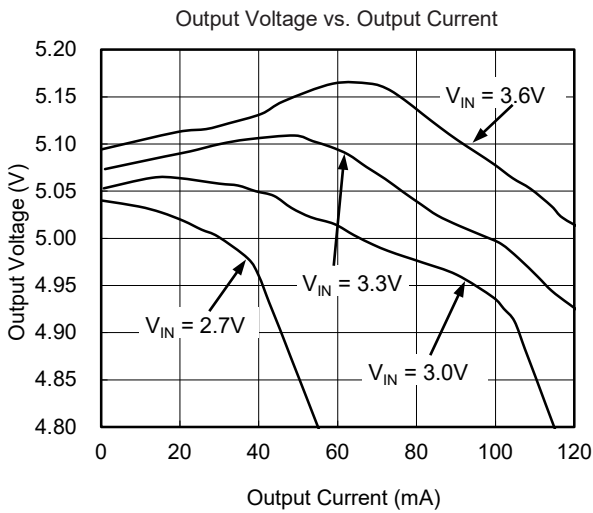
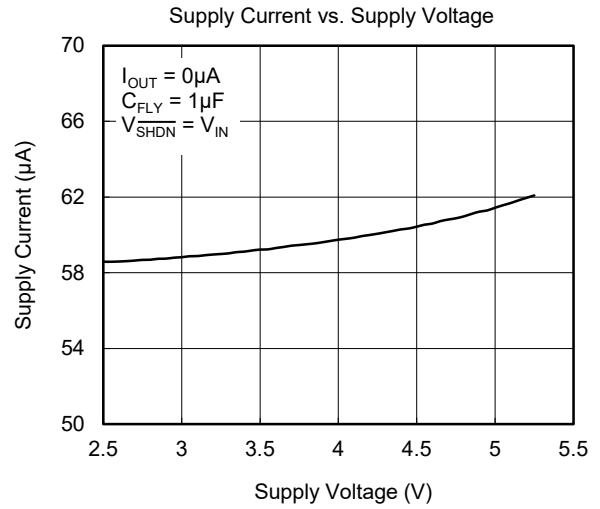
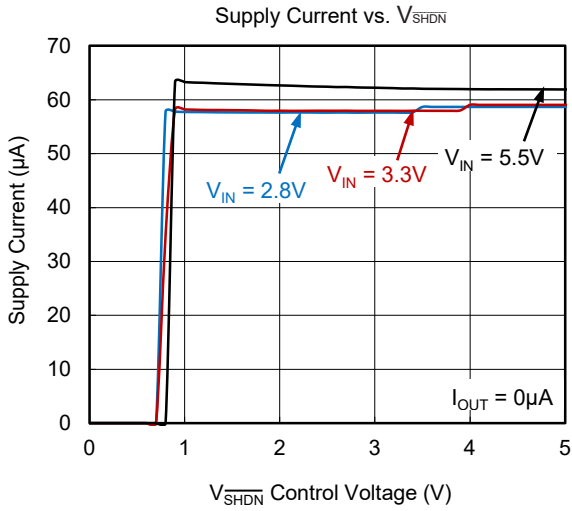

TYPICAL PERFORMANCE CHARACTERISTICS (continued)

At $T_A = +25^\circ\text{C}$, $V_S = 5\text{V}$, $V_{IN} = 3\text{V}$, $C_{IN} = C_{OUT} = 10\mu\text{F}$ and $C_{FLY} = 1\mu\text{F}$, unless otherwise noted.

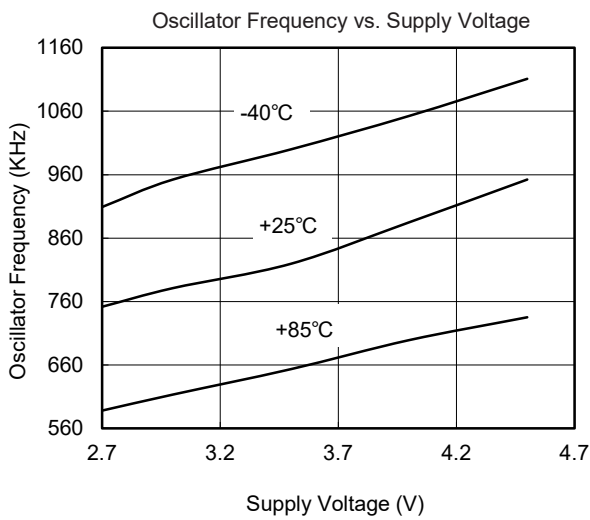
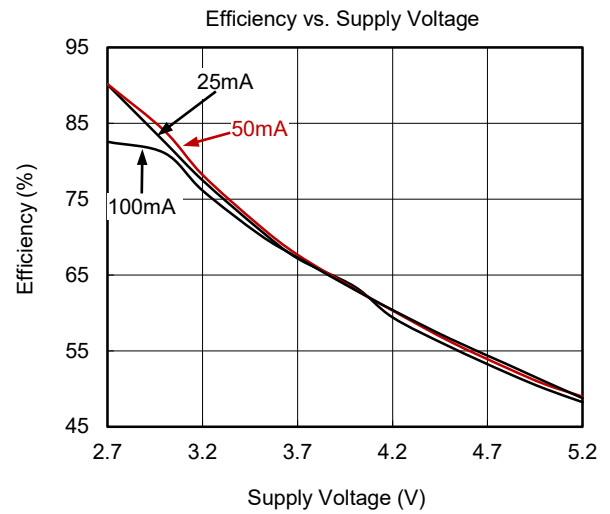
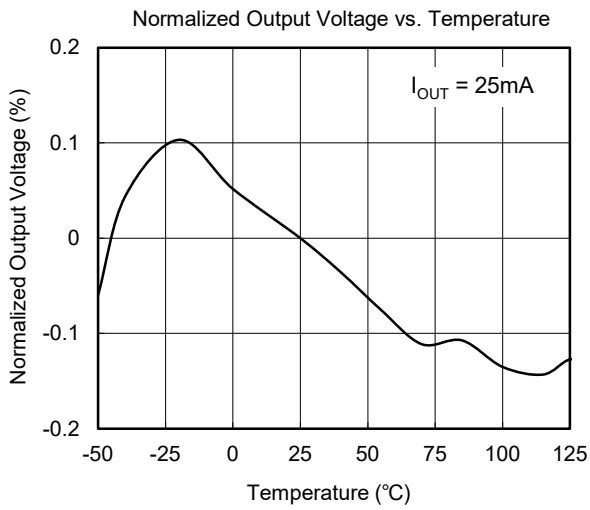

REVISION HISTORY

NOTE: Page numbers for previous revisions may differ from page numbers in the current version.

MARCH 2018 – REV.A.2 to REV.A.3

Added Functional Block Diagram section..... 8

JANUARY 2013 – REV.A.1 to REV.A.2

Added Recommended Land Pattern Information 8
 Added Tape and Reel Information 9, 10

JUNE 2011 – REV.A to REV.A.1

Changed Typical Performance Characteristics section 7

Changes from Original (JANUARY 2009) to REV.A

Changed from product preview to production data..... All

PACKAGE OUTLINE DIMENSIONS

SOT-23-6

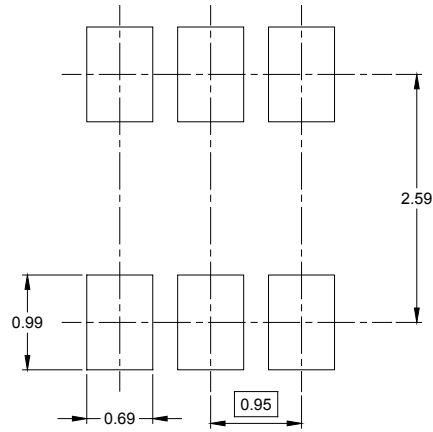
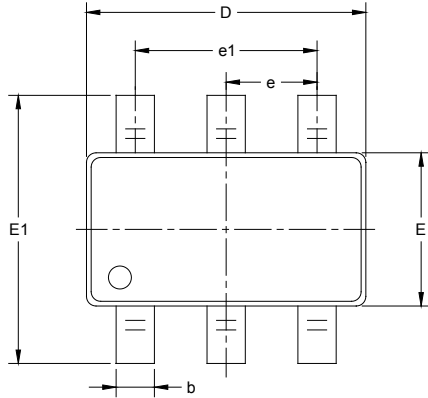

RECOMMENDED LAND PATTERN (Unit: mm)

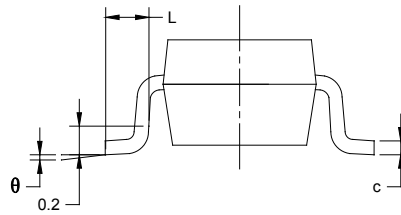
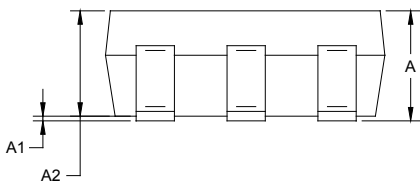

Symbol	Dimensions In Millimeters		Dimensions In Inches	
	MIN	MAX	MIN	MAX
A	1.050	1.250	0.041	0.049
A1	0.000	0.100	0.000	0.004
A2	1.050	1.150	0.041	0.045
b	0.300	0.500	0.012	0.020
c	0.100	0.200	0.004	0.008
D	2.820	3.020	0.111	0.119
E	1.500	1.700	0.059	0.067
E1	2.650	2.950	0.104	0.116
e	0.950 BSC		0.037 BSC	
e1	1.900 BSC		0.075 BSC	
L	0.300	0.600	0.012	0.024
θ	0°	8°	0°	8°

TAPE AND REEL INFORMATION

REEL DIMENSIONS



TAPE DIMENSIONS



NOTE: The picture is only for reference. Please make the object as the standard.

KEY PARAMETER LIST OF TAPE AND REEL

Package Type	Reel Diameter	Reel Width W1 (mm)	A0 (mm)	B0 (mm)	K0 (mm)	P0 (mm)	P1 (mm)	P2 (mm)	W (mm)	Pin1 Quadrant
SOT-23-6	7"	9.5	3.17	3.23	1.37	4.0	4.0	2.0	8.0	Q3

000001

PACKAGE INFORMATION

CARTON BOX DIMENSIONS



NOTE: The picture is only for reference. Please make the object as the standard.

KEY PARAMETER LIST OF CARTON BOX

Reel Type	Length (mm)	Width (mm)	Height (mm)	Pizza/Carton
7" (Option)	368	227	224	8
7"	442	410	224	18

DD0002

X-ON Electronics

Largest Supplier of Electrical and Electronic Components

Click to view similar products for [Isolated DC/DC Converters](#) category:

Click to view products by [SGMICRO](#) manufacturer:

Other Similar products are found below :

[ESM6D044440C05AAQ](#) [FMD15.24G](#) [PSL486-7LR](#) [PSR152.5-7IR](#) [Q48T30020-NBB0](#) [AVO240-48S12B-6L](#) [AVO250-48S28B-6L](#) [NAN-0505](#) [HW-L16D](#) [JAHW100Y1](#) [217-1617-001](#) [22827](#) [SPB05C-12](#) [SQ24S15033-PS0S](#) [18952](#) [19-130041](#) [CE-1003](#) [CE-1004](#) [GQ2541-7R](#) [PSE1000DCDC-12V](#) [RDS180245](#) [MAU228](#) [419-2065-201](#) [449-2075-101](#) [TME 0303S](#) [TME 0505S](#) [TME 1205S](#) [TME 1212S](#) [TME 2405S](#) [TME 2412S](#) [J80-0041NL](#) [V300C24C150BG](#) [419-2062-200](#) [419-2063-401](#) [419-2067-101](#) [419-2067-501](#) [419-2068-001](#) [DCG40-5G](#) [DFC15U48D15](#) [449-2067-000](#) [XGS-0512](#) [XGS-1205](#) [XGS-1212](#) [XGS-2412](#) [XGS-2415](#) [XKS-1215](#) [033456](#) [NCT1000N040R050B](#) [SPB05B-15](#) [SPB05C-15](#)