

**Performance Specification**

Model	Marketing	Maximum							Resistance	
		V <sub>max</sub>	I <sub>max</sub>	I <sub>hold</sub>	I <sub>trip</sub>	P <sub>d</sub>	Time To Trip		R <sub>i min</sub>	R <sub>1max</sub>
		(V dc)	(A)	@25°C (A)	@25°C (A)	Typ. (W)	Current (A)	Time (Sec)	(Ω)	(Ω)
JK-nSMD005SF	JZ	60.0	100	0.05	0.15	0.4	0.25	1.50	3.600	50.000
JK-nSMD010SF	JN	60.0	100	0.10	0.25	0.4	0.50	1.00	1.600	15.000
JK-nSMD012SF	JN	60.0	100	0.12	0.29	0.4	0.50	1.00	1.600	15.000
JK-nSMD020SF	JF	24.0	100	0.20	0.46	0.6	8.00	0.08	0.350	2.700
JK-nSMD025SF	JF	16.0	100	0.25	0.50	0.6	8.00	0.08	0.350	2.500
JK-nSMD035SF	JB	6.0	100	0.35	0.75	0.6	8.00	0.10	0.250	1.300
JK-nSMD050SF	JG	6.0	100	0.50	1.00	0.6	8.00	0.10	0.150	0.700
JK-nSMD050SF/13.2V	JG	13.2	100	0.50	1.00	0.6	8.00	0.10	0.150	0.700
JK-nSMD075SF	JA	6.0	100	0.75	1.50	0.6	8.00	0.20	0.090	0.500
JK-nSMD100SF	JH	6.0	100	1.00	1.80	0.6	8.00	0.30	0.055	0.270
JK-nSMD110SF	JH	13.2	100	1.10	2.20	0.6	8.00	0.30	0.050	0.250
JK-nSMD150SF	15	8.0	100	1.50	3.00	0.8	8.00	0.30	0.040	0.130
JK-nSMD200SF	20	6.0	100	2.00	3.50	0.8	8.00	1.50	0.018	0.080

V<sub>max</sub> = Maximum operating voltage device can withstand without damage at rated current (I<sub>max</sub>).

I<sub>max</sub> = Maximum fault current device can withstand without damage at rated voltage (V<sub>max</sub>).

I<sub>hold</sub> = Hold Current. Maximum current device will not trip in 25°C still air.

I<sub>trip</sub> = Trip Current. Minimum current at which the device will always trip in 25°C still air.

P<sub>d</sub> = Power dissipation when device is in the tripped state in 25°C still air environment at rated voltage.

R<sub>i min/max</sub> = Minimum/Maximum device resistance prior to tripping at 25°C.

R<sub>1max</sub> = Maximum device resistance is measured one hour post reflow.

CAUTION : Operation beyond the specified ratings may result in damage and possible arcing and flame.



**Environmental Specifications**

Test	Conditions	Resistance change
Passive aging	+85°C, 1000 hrs.	±5% typical
Humidity aging	+85°C, 85% R.H. , 168 hours	±5% typical
Thermal shock	+85°C to -40°C, 20 times	±33% typical
Resistance to solvent	MIL-STD-202,Method 215	No change
Vibration	MIL-STD-202,Method 201	No change

Ambient operating conditions : - 40 °C to +85 °C

Maximum surface temperature of the device in the tripped state is 125 °C

**Agency Approval and Environmental Compliance**

Agency	File Number	Regulation	Standard
UL	E217453		2002/95/EC
TUV	pending		EN14582

**Thermal Derating Chart**

Recommended Hold Current(A) at Ambient Temperature(°C)

Model	Ambient Operation Temperature								
	-40°C	-20°C	0°C	25°C	40°C	50°C	60°C	70°C	85°C
JK-nSMD005SF	0.074	0.066	0.058	0.05	0.0425	0.0375	0.035	0.03	0.0275
JK-nSMD010SF	0.148	0.132	0.116	0.10	0.085	0.075	0.07	0.06	0.055
JK-nSMD012SF	0.18	0.16	0.14	0.12	0.10	0.09	0.08	0.07	0.07
JK-nSMD020SF	0.30	0.26	0.23	0.20	0.17	0.15	0.14	0.12	0.11
JK-nSMD025SF	0.37	0.33	0.29	0.25	0.22	0.20	0.17	0.15	0.12
JK-nSMD035SF	0.50	0.45	0.40	0.35	0.30	0.27	0.24	0.21	0.15
JK-nSMD050SF	0.71	0.64	0.57	0.50	0.42	0.39	0.35	0.31	0.25
JK-nSMD050SF/13.2V	0.71	0.64	0.57	0.50	0.42	0.39	0.35	0.31	0.25
JK-nSMD075SF	1.14	1.01	0.88	0.75	0.65	0.59	0.54	0.49	0.41
JK-nSMD100SF	1.45	1.31	1.15	1.00	0.84	0.77	0.69	0.61	0.48
JK-nSMD110SF	1.60	1.45	1.30	1.10	0.95	0.80	0.72	0.66	0.55
JK-nSMD150SF	2.18	1.94	1.72	1.50	1.28	1.17	1.06	0.96	0.77
JK-nSMD200SF	2.88	2.63	2.34	2.00	1.74	1.58	1.42	1.17	0.93

**Thermal Derating Curve**

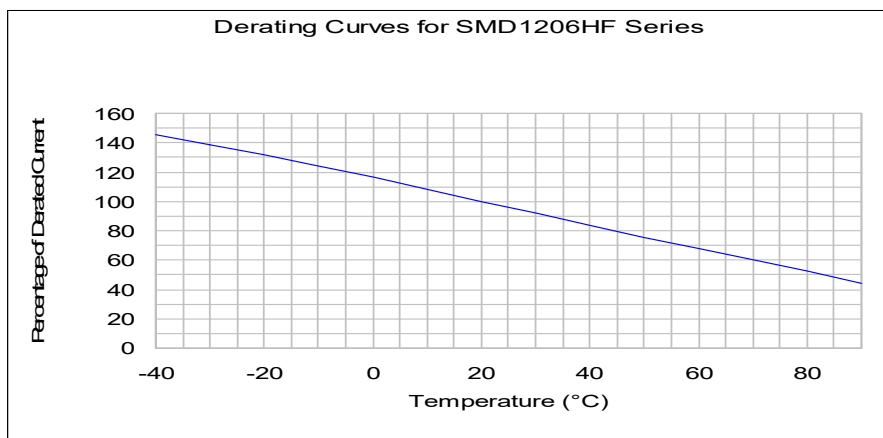

**Average Time-Current Curve**

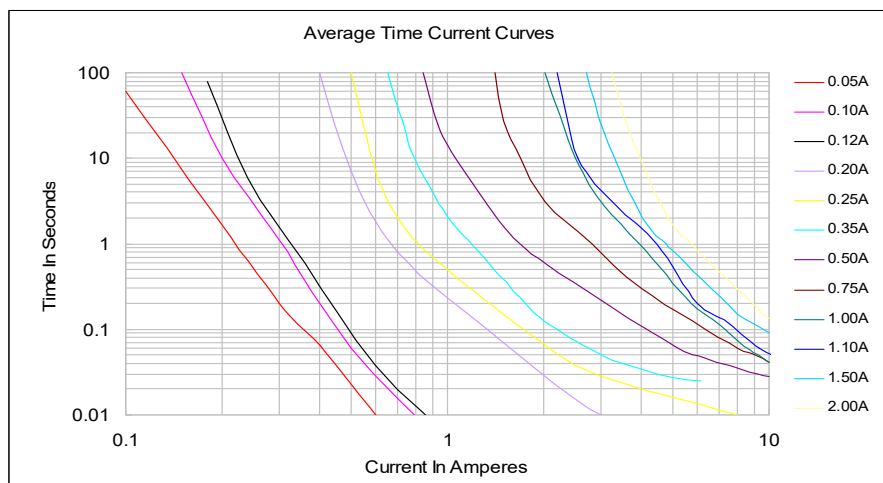

**Soldering Parameters**

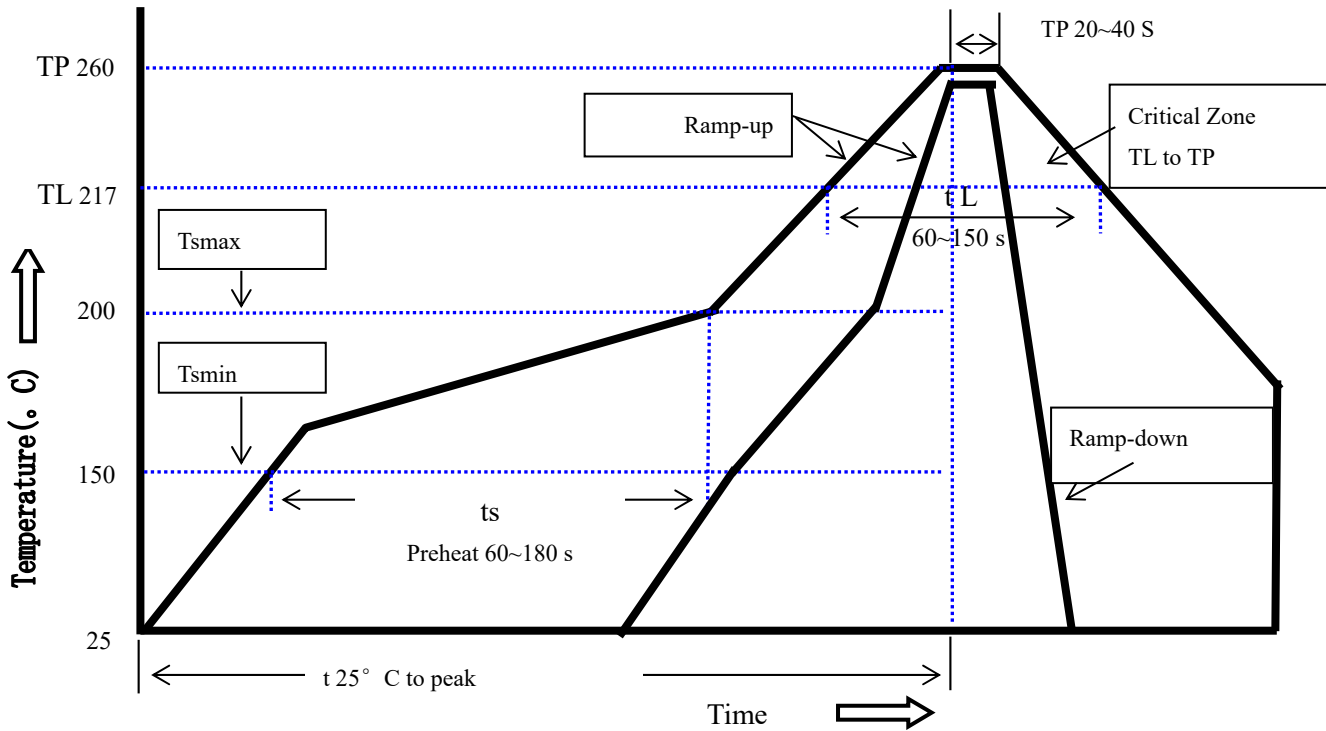

Profile Feature	Pb-Free Assembly
Average Ramp-Up Rate(Ts max to T p)	3°C/second mac.
Preheat	
-Temperature Min(Ts min)	150°C
-Temperature Max(Ts max)	200°C
-Time(Ts min to Ts max)	60~180 seconds
Time maintained above:	
-Temperature(TL)	217°C
-Time(tL)	60~150 seconds
Peak Temperature(Tp)	260°C
Ramp-Down Rate	6°C/second max.
Time 25°C to Peak Temperature	8 minutes max
Storage Condition	0°C~35°C, ≤70%RH

Recommended reflow methods: IR, vapor phase oven, hot air oven, N2 environment for lead-free

Recommended maximum paste thickness is 0.25mm

Devices can be cleaned using standard industry methods and solvents.

Note 1: All temperature refer to topside of the package, measured on the package body surface.

Note 2: If reflow temperatures exceed the recommended profile, devices may not meet the performance requirements.

**Physical Dimensions(mm.)**

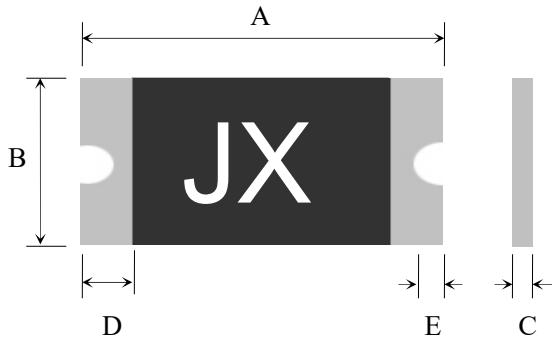

Model	A		B		C		D	E
	Min.	Max.	Min.	Max.	Min.	Max.	Min.	Min.
JK-nSMD005SF	3.00	3.50	1.50	1.80	0.60	1.10	0.15	0.10
JK-nSMD010SF	3.00	3.50	1.50	1.80	0.60	1.10	0.15	0.10
JK-nSMD012SF	3.00	3.50	1.50	1.80	0.60	1.10	0.15	0.10
JK-nSMD020SF	3.00	3.50	1.50	1.80	0.40	0.90	0.15	0.10
JK-nSMD025SF	3.00	3.50	1.50	1.80	0.40	0.90	0.15	0.10
JK-nSMD035SF	3.00	3.50	1.50	1.80	0.40	0.90	0.15	0.10
JK-nSMD050SF	3.00	3.50	1.50	1.80	0.35	0.85	0.15	0.10
JK-nSMD050SF/13.2V	3.00	3.50	1.50	1.80	0.35	0.85	0.15	0.10
JK-nSMD075SF	3.00	3.50	1.50	1.80	0.30	0.80	0.15	0.10
JK-nSMD100SF	3.00	3.50	1.50	1.80	0.40	0.80	0.15	0.10
JK-nSMD110SF	3.00	3.50	1.50	1.80	0.40	0.80	0.15	0.10
JK-nSMD150SF	3.00	3.50	1.50	1.80	0.50	1.20	0.15	0.10
JK-nSMD200SF	3.00	3.50	1.50	1.80	0.50	1.20	0.15	0.10

**Termination Pad Characteristics**

Terminal pad materials: Tin-plated Nickel-Copper

Terminal pad solder ability: Meets EIA specification RS186-9E and ANSI/J-STD-002 Category 3.

**Recommended Pad Layout (mm.)**

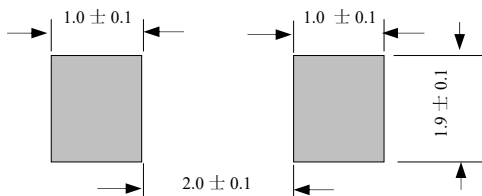

**Packaging Quantity**

Part Number	Quantity
JK-nSMD005.010.012.150.200.SF	3,500 pcs/reel
JK-nSMD020.025.035.050.075.100.110SF	5,000 pcs/reel

Tape & reel packaging per EIA481-1

**Tape And Reel Specifications (mm)**

Governing Specifications		EIA 481-1
W		8.15 ± 0.3
P0		4.0 ± 0.10
P1		4.0 ± 0.10
P2		2.0 ± 0.05
A0		1.95 ± 0.10
B0		3.40 ± 0.10
B1max.		4.35
D0		1.50 + 0.1, -0
F		3.5 ± 0.05
E1		1.75 ± 0.10
E2min.		6.25
T		0.6
T1max.		0.1
K0		1.04 ± 0.1
Leader min.		390
Trailer min.		160
Reel Dimensions		
A max.		178
N min.		60
W1		9 ± 0.5
W2		12.6 ± 0.5

EIA Tape Component Dimensions

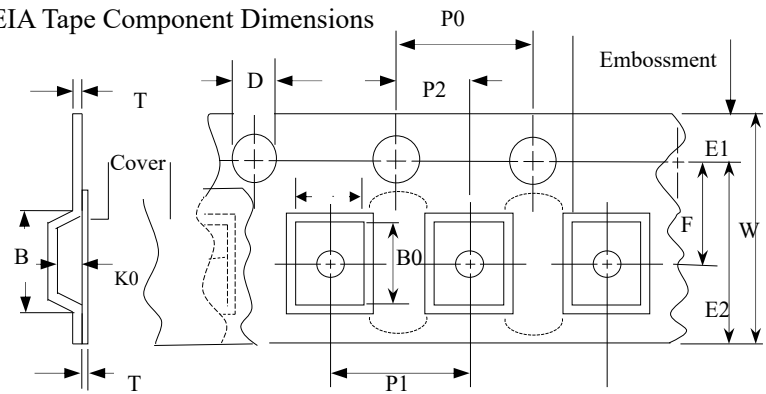

EIA Reel Dimensions

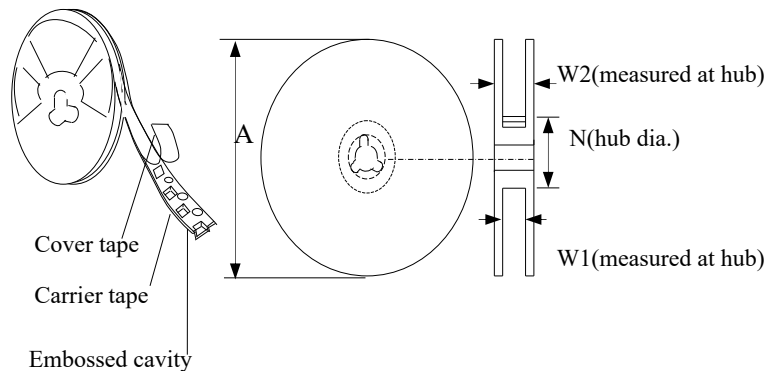

**Storage And Handling**

- Storage conditions: 35°C max, 70% R.H.
- Devices may not meet specified performance if storage conditions are exceeded.

**Part Number System**

JK - nSMD □□□ S F □□ V

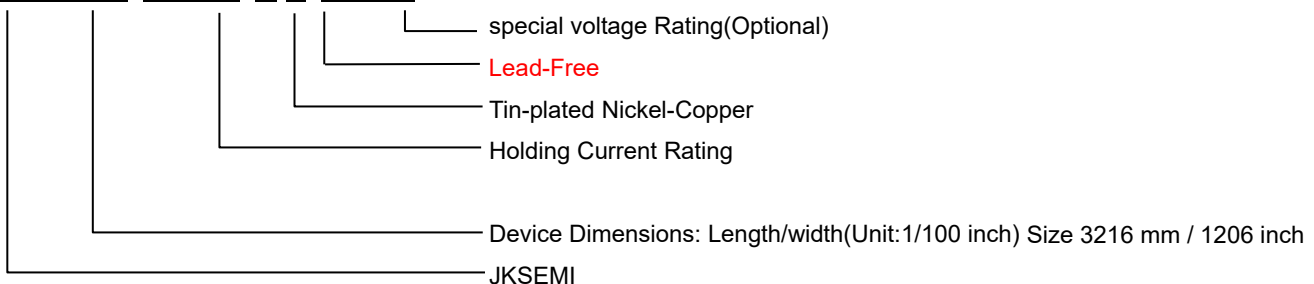

**Cross Reference**

JKSEMI	Cross Reference				
	TYCO/Raychem	Littelfuse	Bourns / Multifuse®	Polytronics / EVERFUSE®	Sea-land
JK-nSMD005SF	-	-	-	-	nSMD005
JK-nSMD010SF	-	-	-	-	nSMD010
JK-nSMD012SF	nanoSMDC012F	1206L012	MF-NSMF012	SMD1206P012TF	nSMD012
JK-nSMD020SF	nanoSMDC020F	1206L020	MF-NSMF020	SMD1206P020TF	nSMD020
JK-nSMD025SF	nanoSMDC025F	1206L025	-	SMD1206P025TF	nSMD025
JK-nSMD035SF	nanoSMDC035F	1206L035	MF-NSMF035	SMD1206P035TF	nSMD035
JK-nSMD050SF	-	1206L050	-	SMD1206P050TF	nSMD050
JK-nSMD050SF/13.2V	nanoSMDC050F/13.2	1206L050	MF-NSMF050	SMD1206P050TF/13.2	nSMD050-13.2
JK-nSMD075SF	nanoSMDC075F	1206L075	MF-NSMF075	SMD1206P075TF	nSMD075
JK-nSMD100SF	-	-	-	-	nSMD100
JK-nSMD110SF	nanoSMDC110F	1206L110	MF-NSMF110	SMD1206P110TF	nSMD110
JK-nSMD150SF	nanoSMDC150F	1206L150	MF-NSMF150	SMD1206P150TF	nSMD150
JK-nSMD200SF	nanoSMDC200F	1206L200	MF-NSMF200	SMD1206P200TF	nSMD200

“Raychem” is a registered trademark of Tyco Electronics.

“Littelfuse” is a registered trademark of Littelfuse

“Multifuse” is a registered trademark of bourns, Inc.

“EVERFUSE” is a registered trademark of Polytronics Technology Corp.

“SEA-LAND” is a registered trademark of Sea-Land electronic corp.

Website: <http://www.jksemi.com>

For additional information, please contact your local Sales Representative.

©Copyright 2016, jk semi

## X-ON Electronics

Largest Supplier of Electrical and Electronic Components

*Click to view similar products for [Resettable Fuses - PPTC](#) category:*

*Click to view products by [Jinkaisheng](#) manufacturer:*

Other Similar products are found below :

[0001.1010.G](#) [D38999/20WG39JN](#) [F02B250V1-4AS](#) [9728214S-2\(621\)](#) [RF0627-000](#) [RF2534-000](#) [ASMD185-2](#) [EN2997S61212AN](#)  
[EN2997SE61203AN](#) [BK-ABC-V-5-R](#) [LR4-550RAF](#) [SMD125-2](#) [F60C500V20AS](#) [RF0078-000](#) [RF1548-000](#) [RF1973-000](#) [RF2171-000](#)  
[RF2531-000](#) [RF2533-000](#) [RF2550-000](#) [TR600-150Q-B-0.5-0.130](#) [BK-AGX-20](#) [5E4795/04-1502](#) [EN2997S61212MN](#) [EN2997SE61203MN](#)  
[EN2997SE61212AN](#) [EN2997SE61212MN](#) [BK1/S505-1.25-R](#) [TR-3216FF20-R](#) [TRF250-080T-B-1.0-0.125](#) [JT06RT1832BN014](#) [S-3-2-10](#)  
[SMD100-2](#) [FRN-R-5-6-10](#) [FRS-R-3-2-10](#) [LP-CC-2-1-2](#) [LPS-RK-3-2-10SP](#) [BK-AGC-1-8-R](#) [BK-AGC-2-10-R](#) [BK-AGC-7-1-2](#) [BK-GDC-](#)  
[500MA](#) [BK-MDL-1-6-10-R](#) [BK-SFE-4](#) [BK-ABC-1-R](#) [BK-C518-250-R](#) [BK-GDB-2A](#) [BK-MDL-1-8-R](#) [BK-MDL-6](#) [BK-AGC-5-R](#) [BK-ATC-](#)