

## 产品应用

### Product Application

目前在汽车电子、网络、通信、家用电子、照明行业以及军事、工业控制等所有电子领域的新一代整机中几乎全部采用了SMT技术，SMT已成为二十一世纪电子信息产业的重要支柱技术之一。而本公司生产的V-CHIP 即片式铝电解电容器便是一种薄型、无引线、高可靠、性能稳定能够满足整机高密度组装之表面贴装技术（SMT）的超小型电子元器件；其广泛应用于通信（如无绳电话、程控交换机等），网络电子（如LCD、扫描仪、复印机、打印机、网络电视机顶盒、保安安防等），汽车电子（如车载电话、汽车音响、电子喷油系统、GPS全球定位系统等），家用电子（如数字电视、数字机顶盒、蓝光DVD等），工业电子（如开关电源、逆变器、监控器、变频器、数控设备、医疗器材、仪器仪表、激光加工设备等等）；可预知：随着电子技术日新月异的发展，片式铝电解电容器的应用领域仍将不断拓宽，终将在铝电解电容器家族中大放异彩！

SMT(surface mounting technology)has already become one pillar of Electronic information industries in 21<sup>st</sup> century,it is used in almost all the electronic field:car electronics,internet, communication, domestic electronics, lighting industry ,as well as military affairs,industrial control,etc. Our V-Chip Aluminum Electrolytic Capacitor,is a subminiature electronics component which is thin,without lead,high reliability,stable performance and can definitely meet the requirement of SMT.It is widely used in communication(such as cordless phones, SPC exchange,etc.),net electronics(such as LCD,scanners, copier,Printers, Network Tv-set Box, security,etc.), car electronics(such as Car Telephones,Car Acoustics,Electronic Blow System,GPS), domestic electronics(such as Digital TV,Set-top Boxes, blu-ray DVD), industrial electronics(such as swithing Mode Power Supply,Inverters,Monitor,Frequency Changer,CNC Equipement, medical equipment, instrument and apparatus,Laser Processing,etc.).What we can presuppose is that with the advancements of electrical technology,V-Chip Aluminum Electrolytic Capacitors will be used more widely and they must be standing under the spotlight in some day.

## 应用案例

### Product Application



# 索引 (略)

<b>铝电解电容器使用注意事项 I</b> CAUTION FOR PROPER USE OF ALUMINUM ELECTROLYTIC CAPACITORS I	1-6
<b>铝电解电容器使用注意事项 II</b> CAUTION FOR PROPER USE OF ALUMINUM ELECTROLYTIC CAPACITORS II	7-8
<b>环境管理物质对应</b> The Environmental management material corresponds	9
<b>典型故障模式及其主要原因</b> Typical failure modes and their factors	10
<b>工艺流程</b> Process Flow	11
<b>客户服务系统图</b> Service flow chart	12
<b>产品编码解析</b> Explanation of Part Number	13
<b>编带规格</b> Taping Dimensions	14-15
<b>焊接方法和再流焊允许范围</b> Soldering method and allowable range of the reflow	16-17
<b>片式铝电解电容品种一览表</b> Chip Schedule of Aluminum Electrolytic Capacitors Variety	18
<b>片式铝电解电容产品目录</b> Chip Aluminum Electrolytic Capacitors Product List	19-38

**铝电解电容器使用注意事项 I****CAUTION FOR PROPER USE OF ALUMINUM ELECTROLYTIC CAPACITORS I**

在使用铝电解电容器时请注意以下几点。

Upon using Aluminum Electrolytic Capacitors, please pay attention to the points listed below.

铝电解电容器在承载以下负荷时，将造成其特性急剧恶化。

When the following types of electrical loads indicated below are applied to Aluminum Electrolytic Capacitors, rapid deterioration of electrical property occurs:

- 反向电压
- 电压超过额定值
- 纹波电流超过额定值
- 急速充放电
- reverse voltage
- voltage exceeds rated voltage
- rated ripple current is exceeded
- severe charging/discharging

此时，电容器可能产生大量热，内部气压上升，导致压力阀开启，内部气体喷出，漏液等。

At such times, severe heat is generated, gas is emitted, then electrolyte leaks from the sealing area, and pressure relief vent operates due to internal pressure.

在某此情况下，伴随电容器损坏会有可燃物的迸发，有可能导致爆炸和起火。

On some condition, explosion or ignition may occur, and along with destruction of the capacitor combustibles may burst out.

**1. 电路设计注意事项 CAUTION DURING CIRCUIT DESIGN****1) 使用环境、安装环境以及额定性能的确认**

- 请确认使用环境以及安装环境符合电容器的商品目录与缴纳规格书。

**OPERATIONAL ENVIRONMENT, MOUNTING ENVIRONMENT AND CONDITIONS.**

- Ensure that operational and mounting conditions follow the specified conditions detailed in the catalog and specification sheets.

**2) 使用温度、纹波电流以及寿命**

- 请在商品目录及缴纳规格书中所规定的工作温度范围和纹波电流范围内使用。
  - ① 不要在高温（超过工作温度上限）下使用。
  - ② 不要让过电流（超过额定纹波电流）通过电容器。
- 根据加速试验的结果，可以通过寿命推算公式来计算电容器的寿命。但是推算所得的寿命存在误差，不能作为保证值使用。请以推算所得的结果为参考，选择有足够使用寿命的电容器。关于寿命推算方法，请参阅本公司的网站，或至本公司咨询。

**OPERATING TEMPERATURE, RIPPLE CURRENT AND LOAD LIFE**

- Operating temperature and applied ripple current should be within the specified value in the catalog or specification sheets.
  - ① Do not use Aluminum Electrolytic Capacitors at temperature which exceeds the specified category temperature range.
  - ② Do not apply excessive current to the capacitors, which exceeds the specified rated ripple current.
- Life time of capacitors can be calculated with "life estimation equation" base on acceleration test results of the capacitors. The life time calculated by the equation is not a guaranteed value as it contains errors and variations. It is recommended to select a capacitor with enough safety factor on the calculation results against expected life of the devices. Please refer to the article from our web-site or consult with us for information regarding "life estimation equation".

**3) 使用电路**

- 电容器需区分极性使用。请不要施加反向电压或交流电压。在极性反转的电路中，请选择使用双极性电容器。但是，双极性电容器不可使用于交流电路。
- 请不要在重复急速充放电的电路中使用电容器。关于重复充放电电路中使用的电容器，请咨询我们。

**APPLICATION**

- Aluminum Electrolytic Capacitors are normally polarized. Reverse voltage or AC voltage should not be applied. When polarity of applied voltage is uncertain or when the polarity may flip over, non-polar type capacitors should be used, but the non-polar type cannot be used for AC circuit.
- Standard Aluminum Electrolytic Capacitors are not suitable for rapid charge and discharge applications. Consult with Rubycon about specially designed capacitors for rapid charge and discharge.

**4) 施加电压**

- 不要将过电压（超过额定电压的电压）施加于电容器。

**APPLIED VOLTAGE**

- Do not exceed the rated voltage of capacitors.

## 5) 电容器的绝缘

- 在以下情况，请将电容器与电路完全隔离。
  - ① 铝壳和阴极端子，阳极端子以及电路配线之间
  - ② 自立型的无连接端子（增强强度用）和其他的阳极端子，阴极端子以及电路配线之间
- 电容器的外装套管，不能保证绝缘性。请勿用于需要绝缘的地方。若需要套管具有绝缘功能时，请咨询我们。

## INSULATION

- Aluminum Electrolytic Capacitors should be electrically isolated from among the following points.
  - ① Aluminum case, cathode lead wire, anode lead wire and circuit pattern.
  - ② Auxiliary terminals of snap-in type, anode terminal, outward terminal and circuit pattern.
- The sleeve of Aluminum Electrolytic Capacitors is not recognized as an insulator, and therefore, the standard capacitor should not be used in a place where insulation function is needed. Please consult with Rubycon should you require a higher grade of insulating sleeve.

## 6) 使用环境的限制

- 请不要在以下环境中使用电容器。
  - ① 直接溅水，盐水，油或处于结露状态的环境
  - ② 充满有害气体（硫化氢、亚硫酸、亚硝酸、氯气、氨气、溴等）的环境
  - ③ 有臭氧、紫外线及放射线照射的环境
  - ④ 振动或冲击条件超过商品目录或缴纳规格书规定范围的过激环境

## CONDITIONS OF USE

- The following environment should be avoided when using Aluminum Electrolytic Capacitors.
  - ① Damp conditions such as water, saltwater spray, or oil spray or fumes. High humidity or humidity condensation situations.
  - ② Hazardous gas/fumes such as hydrogen sulfide, sulfurous acid gas, nitrous acid, chlorine gas, ammonia or bromine gas.
  - ③ Exposure to ozone, ultraviolet rays or radiation.
  - ④ Severe vibration or shock which exceeds the condition specified in the catalog or specification sheets.

## 7) 安装环境的设计

- 将电容器安装至印刷电路板时，需事先确认以下内容，再进行设计。
  - ① 请确认电容器的端子间隙与印刷电路板孔间隙一致。
  - ② 设计时不可将配线及电路板延伸到电容器压力阀上方。
  - ③ 请按商品目录或缴纳规格书的规定，在电容器的压力阀部位，空出一定的间隙。
  - ④ 铝电解电容器的压力阀接触到印刷电路板时，请在印刷电路板的正对位置上设置排气孔。

## CONSIDERATION TO ASSEMBLY CONDITION

- In designing a circuit, the following matters should be ensured in advance to the capacitor's assembly on the printed wiring board(PW board).
  - ① Design the appropriate hole spacing to match the lead pitch of capacitors.
  - ② Do not locate any wiring and circuit patterns directly above the capacitor's vent.
  - ③ Ensure enough free space above the capacitor's vent, The recommended space is specified in the catalog or specification sheets.
  - ④ In case the capacitor's vent is facing the PW board, make a gas release hole on PW board.

## 8) 印刷电路板的设计

- 请不要在电容器的封口部下方进行电路配线。
- 请不要在电容器周围及印刷电路板的另一侧（电容器的下方）配置发热部件。
- 用于贴片电容器的印刷电路板，其焊盘设计请参照商品目录或缴纳规格书的规定进行。

## CONSIDERATION TO CIRCUIT DESIGN

- Any copper lines or circuit patterns should not be laid under the capacitor.
- Parts which radiate heat should not be placed close to or reverse side of the Aluminum Electrolytic Capacitors on the PW board.
- Land pattern of chip type capacitors should comply with the specification which is mentioned in the catalog or specification sheets.

## 9) 其他

- 电容器的电特性会根据环境温度和使用频率的变化而变化。请在确认该变化量的基础之上进行电路设计。
- 在双面印刷电路板上安装电容器时，请不要在电容器下面设计多余的印刷电路板孔及正反面连接用贯通孔。
- 并联2个以上的电容器时，请考虑到电流的平衡。
- 串联2个以上的电容器时，请考虑到电压的平衡，并插入分压电阻。

## OTHERS

- Performance of electrical characteristics of Aluminum Electrolytic Capacitors are affected by variation of operating temperature and frequency. Consider this variation when designing the circuit.
- Excessive holes and connection hole between both sides on the PW board should be avoided around or under the mounting area of the Aluminum Electrolytic Capacitors on double sided or multilayer PW board.
- Consider current balance when 2 or more Aluminum Electrolytic Capacitors are connected in parallel.
- Use bleeder resistors when 2 or more Aluminum Electrolytic Capacitors are connected in series. In this case, the resistors should be connected parallel to the capacitors.

使用在有安全性要求的电子设备上时，需考虑电解电容器的故障模式，从设计上确保安全性。

- 利用保护电路、保护装置提高系统的安全性。
- 利用冗余电路，提高系统的安全性。

From the perspective of the importance of safety with electronic equipments and circuits, please observe safety measures in light of capacitor failure modes at the design stage.

- System to promote safety in circuit care and protective equipment.
- System to promote safety with redundant circuits, etc.

## 2. 安装注意事项 CAUTION FOR ASSEMBLING CAPACITORS

## 1) 安装前的预备知识

- 对组装到设备上，且已经通过电的电容器，请勿再次使用。除了在定期检修时，为检测电特性而取下的电容器外，均不可再次使用。
- 电容器可能会发生再起电压。这种情况，请使用约1K $\Omega$ 的电阻进行放电。
- 长期保管的电容器漏电流有可能会增大。这种情况，请使用约1K $\Omega$ 的电阻进行电压处理。

## CAUTION BEFORE ASSEMBLY

- Aluminum Electrolytic Capacitors cannot be recycled after mounting and applying electricity in unit. The capacitors which are removed from PW board for the purpose of measuring electrical characteristics at the periodical inspection should only be recycled for the same position.
- Aluminum Electrolytic Capacitors may accumulate charge naturally during storage. In this case, discharge through a 1K $\Omega$  resistor before use.
- Leakage current of Aluminum Electrolytic Capacitors may be increased during long storage time. In this case, the capacitors should be subject to voltage treatment through a 1K $\Omega$  resistor before use.

## 2) 安装时-1

- 请确认电容器的额定值（静电容量及电压）后，再进行安装。
- 请确认电容器的极性后，再进行安装。
- 请勿将电容器跌落到地上。跌落到地上的电容器，请不要再使用。
- 安装时请勿使电容器变形。

## IN THE ASSEMBLYPROCESS-1

- Ensure rated voltage and capacitance of the capacitors before mounting.
- Ensure the capacitor's polarity before mounting.
- Do not use a capacitor which has been dropped onto a hard surface.
- Do not use capacitors with damaged or dented cases or seals.

### 3) 安装时-2

- 请确认电容器的端子间隙与印刷电路板孔隙一致后，再进行安装。
- 利用自动插入机对电容器的引线进行弯曲以固定在印刷电路板上时，力量不能过大。
- 请注意自动插入机及装配机的吸附器、产品检验器及位置对准操作所引起的冲击力。
- 若担心组装中有振动、冲击等，安装电容器至印刷电路板时，请使用辅助工具、粘合剂等增强其牢固性。

### IN THE ASSEMBLY PROCESS-2

- Capacitors should be mounted after confirmation that hole spacing on PW board matches the lead pitch of the capacitors.
- Avoid excessive force when clinching lead wire during auto-insertion process.
- Avoid excessive shock to capacitors by automatic insertion machine, during mounting, parts inspection or centering operations.
- Please utilize supporting material such as strap or adhesive to mount capacitors to PC board when it is anticipated that vibration or shock is applied.

### 4) 电烙铁焊接

- 焊接条件(温度、时间)不可超过商品目录或缴纳规格书的规定范围。
- 端子间隙与印刷电路板孔穴间隙不一致，而在焊接前进行加工时，不能使电容器主体承受应力。
- 利用电烙铁进行手工修整时，如果需要将焊接好的电容器卸下，请将焊锡充分融化后再取下，以免使电容器的端子承受压力。
- 请勿用电烙铁的前端接触电容器的主体。

### SOLDERING

- Soldering conditions (temperatures, times) should be within the specified conditions which are described in the catalog or specification sheets.
- In case lead wire reforming is needed due to inappropriate pitch between capacitor and holes on PW board, stress to the capacitor should be avoided.
- In case soldered capacitor has to be withdrawn from the PW board by soldering irons, the capacitor should be removed after solder has melted sufficiently in order to avoid stress to the capacitor or lead wires.
- Soldering iron should never touch the capacitor's body.

### 5) 波峰焊接

- 进行焊接时，请勿将电容器主体浸入熔融状态的焊锡中。插入印刷电路板作为阻隔，只对放电容器侧反面的电路板表面进行焊接。
- 焊接条件(预热、焊接温度、端子浸渍时间)不可超过商品目录或缴纳规格书规定的范围。
- 端子以外部分，不可附着助焊剂。
- 在焊接时，注意避免其他部件翻倒接触到电容器。

### FLOW SOLDERING

- Do not dip capacitor's body into molten solder.
- Soldering condition (preheat, soldering temperature, dipping time) should be within the specified standard which is described in the catalog or specification sheets.
- Flux should not be adhered to capacitor's body but only to its terminals.
- Other devices which are mounted near capacitors should not touch the capacitors.

### 6) 回流焊接

- 焊接条件(预热、焊接温度、时间、回流焊接次数)，不可超过商品目录或缴纳规格书所规定的范围。  
※) 需要进行超过规定范围的回流焊接时，务必请联系我们。
- 使用红外线加热器时，对红外线的吸收率因电容器的颜色和材质不同而异，请注意加热的程度。

### REFLOW SOLDERING

- Reflow soldering conditions (preheat, soldering temperature, reflow time, reflow cycle) should follow the specified standard which are described in the catalog or specification sheets (※) Consult with Rubycon when use beyond the specified standard are need.
- Heating standard should depend on surface of the capacitor color or materials when infrared rays is used because the capacitor's heat absorption depends on the surface color or materials. Check heat condition.

#### 7) 焊接后的处理

- 将电容器焊接在印刷板上之后，请不要将电容器的主体倾倒或扭曲。
- 不可抓住电容器的主体搬运电路板。
- 将电容器焊接在印刷电路板上之后，避免其与其他物体发生碰撞。  
此外，重叠放置印刷电路板时，不可以让印刷电路板或其他部件碰到电容器。

#### HANDLING AFTER SOLDERING

- Do not bend or twist the capacitor's body after soldering on PW board.
- Do not pick-up or move PW board by holding the soldered capacitors.
- Do not hit the capacitors and isolate capacitors from the PW board or other device when stacking PW boards in store.

#### 8) 印刷电路板的清洗

- 不可使用含卤溶剂清洗电容器。但是必须清洗时，请使用耐清洗的电容器，并在商品目录或缴纳规格书的规定范围内使用。
- 清洗耐清洗的电容器时，请充分做好清洗剂的污染管理工作（电导率、pH值、比重、含水量等）。
- 清洗耐清洗的电容器后，请勿将其保管在有清洗液的环境中或密闭容器内。  
此处，在清洗后，请用热风对印刷电路板和电容器进行充分干燥。热风温度请控制在工作上限温度以下。

#### HANDLING AFTER SOLDERING

- Standard Aluminum Electrolytic Capacitors should be free from halogenated solvents during PW board cleaning after soldering. Use solvent proof capacitors and follow the specified cleaning condition when halogenated solvents are used.
- Solvents should have well controlled conductivity, pH, specific gravity and water contents during the cleaning of solvent proof capacitors.
- Cleaned PW board with capacitors should not be kept in solvent environment or nonventilated places. Let PW board containing capacitors after cleaning dry with hot blast fully. The temperature of such breeze should be under the upper category temperature of capacitors.

#### 9) 固定剂、涂层剂

- 请不要使用含卤溶剂等的固定剂、涂层剂。
- 在使用固定剂和涂层剂之前，请将基板和电容器的封口部位之间清扫干净，不可留有助焊剂残渣及污垢。
- 在使用固定剂和涂层剂之前，请对电容器上附着的清洗剂等进行干燥。
- 在使用固定剂和涂层剂时，请不要将电容器封口部全部堵塞。

#### ADHESIVES AND COATING MATERIALS

- Do not use halogenated adhesives and coating materials to fix Aluminum Electrolytic Capacitors.
- Flux between the surface of the PW board and sealing of capacitors should be cleaned before using adhesives or coating materials.
- Solvents should be dried up before using adhesives or coating materials.
- Do not cover up all the sealing area of capacitors with adhesives or coating materials, make coverage only partial.

### 3. 配套使用中的注意事项 CAUTION DURING USE OF CAPACITORS IN SETS

- 请勿直接接触电容器的端子。
- 请勿使用导体导致电容器的端子间短路。此外，不可以使电容器接触酸性或碱性等导电性溶液。
- 请确认使用环境及安装环境在商品目录或缴纳规格书所规定的额定性能范围。
  - Do not touch the terminals of capacitors.
  - Do not connect electrical terminals of the capacitor. Keep the capacitors free from conductive solution, such as acid, alkali and so on.
  - Ensure the operational environment of the equipment in which the capacitor has been built is within the specified condition mentioned in the catalog or specification sheets.

### 4. 保养检修 MAINTENANCE

- 对于工业中使用的电容器，请定期进行检修。检修项目包括如下内容。
  - ① 外观：开阀、液体泄漏等明显异常。
  - ② 电特性：漏电流、静电容量、损耗角正切值以及商品目录或缴纳规格书中规定的项目。
- Periodical inspection should be carried out for the capacitors, which are used with industrial equipment. Check the following points at the inspection.
  - ① Visual inspection to check pressure relief open or leakage of electrolyte.
  - ② Electrical characteristics: leakage current, capacitance, dissipation factor and the other points which are mentioned in the catalog or specification sheets.

## 5. 紧急情况 EMERGENCY ACTION

- 在配套设备使用过程中，电容器开阀。并喷出气体时，请切断设备的主电源或者将电源线的插头从插座中拔出。
- 电容器的压力阀开启时，将喷出超过+100°C 的高温气体，此时不可以将脸部靠近。  
若喷出的气体进入眼睛或被吸入时，应立即用水洗净眼部或漱口。  
不可以舔食电容器的电解液，如果电解液溅到皮肤，请用肥皂进行冲洗。
- When the pressure relief vent is open and some gas blows out from the capacitor, please turn the main switch of the equipment off or pull out the plug from the power outlet immediately.
- During pressure relief vent operation, extremely hot gas(over 100 °c )may blow out from the capacitors. Do not stand close to the capacitors. In case of eye contact, flush the open eye(s) with large amount of clean water immediately. In case of ingestion, gargle with water immediately, do not swallow. Do not touch electrolyte but wash skin with soap and water in case of skin contact.

## 6. 保管条件 STORAGE CONDITION

- 请不要在高温高湿的环境中保管电容器。请保管在温度5°C ~ 35°C，相对湿度在75%以下的室内。
- 不要在能够直接接触到水，盐水以及油的环境中保管电容器。
- 请不要在充满有害气体（硫化氢、亚硫酸、亚硝酸、氯气、氨气、溴等）的环境中保管电容器。
- 请不要在有臭氧、紫外线及放射线照射的环境中保管电容器。
- Aluminum Electrolytic Capacitors should not be stored in high temperatures or where there is a high level of humidity. The suitable storage condition is 5 °c~35 °c and less than 75% in relative humidity.
- Aluminum Electrolytic Capacitors should not be stored in damp conditions such as water, saltwater spray or oil spray.
- Do not store Aluminum Electrolytic Capacitors in an environment full of hazardous gas (hydrogen sulfide, sulfurous acid gas, nitrous acid, chlorine gas, ammonia or bromine gas).
- Aluminum Electrolytic Capacitors should not be stored under exposure to ozone, ultraviolet rays or radiation.

## 7. 废弃处理 DISPOSAL

- 在废弃电容器时，请采用以下任意一种方式。
  - ① 在电容器上开孔或充分粉碎后高温（800°C 以上）焚烧。
  - ② 在不进行焚烧处理时，应交给专业的工业废弃物处理工厂，由其代为处理。
- Please take either of the following actions in case of disposal.
  - ① Incineration (high temperature of more then 800 °c after crushing the capacitor's body).
  - ② Consignment to specialists of industrial waste.

※详细内容请参阅 JEITA RCR-2367B

**JEITA RCR-2367B**

《电子机器用固定铝电解电容器使用注意事项指南》

### For further details

Please refer to: JEITA RCR-2367B (Safety Application Guide for fixed aluminum electrolytic capacitors for use in electronic equipment).



## 铝电解电容器使用注意事项 II

CAUTION FOR PROPER USE OF ALUMINUM ELECTROLYTIC CAPACTORS II

## 1. 关于直流用电解电容器的极性表示 Polarity Marking of Electrolytic Capacitors

使用时请确认不要将其接入反向电压或交流电压。极性的表示方法有以下3种。

1. 在主体侧面：有带状或箭头状标记的为阴（负）极。
2. 引线端子同方向型铝电解电容器，在引线未加工时，引线端子短的一方为阴（负）极。
3. 外壳上面有盖印的铝电解电容器，印有[◀]形状的为阴（负）极。

Please confirm the polarity to avoid applying any reverse voltage or AC voltage to the capacitors. Polarity is indicated as below:

1. Negative polarity is indicated on the side of body by means of a stripe or an arrow.
2. On radial leaded Aluminum Electrolytic Capacitors, the shorter lead is the negative terminal on long lead version.
3. Capacitors with markings on top of case, the mark [◀] indicates the direction of Negative Polarity.

## 2. 关于带有压力阀的电容器 Mounting Capacitors with Pressure relief Vent

带有压力阀的铝电解电容器被设计为，在施加反向电压、过电压或者流过的纹波电流超过额定值时，压力阀开启，放出含有电解液的高温气体。

- 设计时不可将配线及电路板靠近电容器的压力阀部分。
- 外壳的压力阀在工作时压力阀部分会膨胀。安装基板时不要接触到装置的上盖，参照下表空出一定的间隙。若不空出间隙，则压力阀不会工作。

Aluminum Electrolytic Capacitors are designed to open the pressure relief vent and release hot gas including electrolyte through it, in abnormal cases such as when reverse voltage or excess voltage was applied, or when ripple current exceeding the permissible value has flown into capacitors.

- Do not design to locate any wiring or circuit pattern around the capacitor's pressure relief vent.
- The pressure relief vent bulges right before the vent operation. Ensure enough free space directly above the capacitor's vent as shown in the below table so that bulged vent never touches to an object such as the case on cover of the set. The pressure relief vent will not open without the appropriate free space.

外壳直径 Body Dia.	φ6.3 ~16mm	φ18 ~35mm	φ40mm ~	间隙 Space	2mm MIN.	3mm MIN.	5mm MIN.
-------------------	------------	-----------	---------	-------------	----------	----------	----------

## 3. 关于电压处理 Voltage Treatment

对于长时间放置的产品，请按照下述方法进行电压处理。

- 电压处理  
将约1kΩ的保护电阻与电容器串联连接，并施加与额定电压相同的直流电压1小时。然后接通1Ω/V的电阻进行放电。  
The following voltage treatment should be done on the capacitors that have been stored for a long time.

- Voltage Treatment  
The capacitors shall be applied with a DC voltage which is equal to the Rated Voltage of the capacitor through a resistor of about 1kΩ in series for 1 hour, and then discharged through a resistor of about 1Ω/Volt.

## 4. 关于纹波电流 Ripple Current

1. 直流电压与纹波电压峰值之和不超过额定电压，且不成为反向电压。
2. 在铝电解电容器端子间的纹波电压变动幅度较大时，按急速充放电处理。当纹波电压的变动幅度超过70Vp-p时，请联系我们。

The combined value of D.C. voltage and the peak A.C. voltage shall not exceed the rated voltage and shall not be reverse voltage.

Use of aluminum electrolytic capacitor under ripple voltage with wide amplitude is equivalent to quick charge-discharge operation.

If ripple voltage with the amplitude over 70Vp-p is expected, please contact us.

5. 关于清洗电路板 PW BOARD CLEANING

1. 小型电解电容器的清洗100WV以下产品时，请在60°C以下的清洗液中浸渍（也可是超声波）。浸渍时间控制在5分钟以内（5L, 7L品为3分钟）。且清洗和干燥要充分。

（溶剂）Pine Alpha ST-100S Clean Through 750HIPA（异丙醇）

- 基于地球环境保护，请避免使用破坏臭氧层的物质作为清洗剂。
- 某些产品不能够进行清洗，请参照规格书的清洗耐受性项目。此外，若使用上述以外的清洗剂，请务必在使用时通报我们。

The board should be thoroughly rinsed And dried Recommended deaning solvene incbude pine Alpha ST-100S clean-thru 750H IPA (isopropyl alcohol)

PW board can be immersed or ultrasonically cleaned using suitable cleaning solvents for up to 5 minutes (5L and 7L is up to 3 minutes) and up to 60°C maximum temperatures about Miniature Aluminum Electrolytic Capacitors 100wv or less.

- The use of ozone depleting cleaning agents are not recommended in the interest of protecting the environment.
- Certain products may not be cleaned. Please refer to the Specification notes. Also, please consult us when using cleaning solvents other than those above listed.

清洗剂 Cleaning Solvents	清洗条件 Cleaning Condition
Pine Alpha ST-100S Pine alpha ST-100S Clean Through 750H Clean-thru 750H IPA (异丙醇) IPA (isopropyl alcohol)	对于100WV以下产品，使用60°C清洗液浸渍、蒸汽、超声波以及使用三种方法的组合，可以耐受5分钟以内的时间(5L、7L品为3分钟以内) Is less than 5 minutes by dipping, steam, ultrasonically cleaned and these combinations. (5L and 7L is less than 3 minutes)

2. 注明可以清洗的电容器，请按规格书中规定的清洗剂、清洗条件（温度、时间等）进行清洗。并且，请不要使用下述溶剂清洗电容器。

- 含卤溶剂：腐蚀电容器内部  
清洗剂会渗入（扩散）电容器内部，并发生分解反应生成卤素离子，它与铝发生反应，有可能造成电容器的腐蚀。特别注意要绝对避免使用1-1-1三氯乙烯。在使用ASAHIKLIN AK-225AES时，请咨询我们。
- 碱性溶剂：腐蚀铝壳（溶解）
- 石油类溶剂：使封口处的橡胶劣化
- 二甲苯：使封口处的橡胶劣化
- 丙酮：使标示消失

For solvent resistant capacitors, carefully follow the temperature and time requirements of the specification, Avoid using the following solvent groups.

- Halogenated cleaning solvents: except for solvent resistant capacitor types, halogenated solvents can permeate the seal and cause internal capacitor corrosion and failure. 1-1-1 trichloroethane should never be used on any aluminum electrolytic capacitor.  
Please consult us when using ASAHIKLIN AK-225AES solvent.
- Alkali solvents: could attack and dissolve the aluminum case.
- Petroleum based solvents: deterioration of the rub-ber seal could result.
- Xylene: deterioration of the rubber seal could result.
- Acetone: removal of the ink markings on the vinyl sleeve could result.

3. 基板清洗后，请注意不要将清洗剂残留在电容器封口部位和印刷电路板间、并进行强制性干燥。（不高于工作温度上限）

A thorough drying after cleaning is required to remove residual cleaning solvents which may be trapped between the capacitor and the circuit board. Avoid drying temperatures which exceed the upper category temperature of the capacitor.

4. 请充分做好清洗剂的污染管理工作（电导率、pH值、比重、含水量等）。

若发生清洗剂污染，卤素浓度升高，电容器内部可能发生腐蚀情况。

清洗剂中的助焊剂浓度，请控制在2%wt以下。

Monitor the contamination levels of the cleaning solvents during use by electrical conductivity, PH, specific gravity, or water content, Chlorine levels can rise with contamination and adversely affect the performance of the capacitor.

7. 关于电解液、电解纸 Electrolyte and Separator paper

铝电解电容器所使用的电解液、电解纸为可燃物质。并且电解液带有导电性，若附着于印刷电路板上，有可能会腐蚀电路板或配线板，造成电路板配线间的短路。甚至导致冒烟起火。

Electrolyte and separator paper used in Aluminum Electrolytic Capacitors are flammable. Also, Electrolyte is electrically conductive. Therefore, in case Electrolyte gets contact with PC board, it may cause corrosion of circuit pattern, or tracking or short circuit between patterns, and may lead to smoke generation or ignition at the worst cases. Please make considerations to the above risk in designing circuit patterns and determining the mounting method and mounting location of capacitors.

8. 关于熏蒸、消毒作业、含卤阻燃剂 Fumigation, Disinfection and halogenated flame retardant

下述条件会造成电容器内部电极、外壳以及端子表面的腐蚀敬请注意。

1. 为驱除害虫，而对木质托盘的熏蒸处理。
2. 与含有含卤阻燃剂（溴水等）的元件一同使用。
3. 预防传染病的含卤类清洗剂、消毒剂直接附着于电容器的情况。

It may cause corrosion of internal electrodes, aluminum cases and terminal surface when the following conditions exist.

1. Fumigation of wooden pallets before shipment to disinfect vermin.
2. Existence of components or parts that contain halogenated flame retardant agent (bromine etc.) together with capacitors.
3. When halogenated detergents of antiseptics for preventing infection of epidemic diseases contact directly to capacitors.

环境管理物质对应

The Environmental management material corresponds

ROHS管理物质  
Management material of ROHS

品名 name	种类 variety	对应的ROHS 指令 Command of ROHS	铅 Lead	镉 Cadmium	水银 Mercury	六价铬 Hexavalent Chromium	PBB	PBDE	ROHS对应品 的标示 Mark of ROHS
铝电解 电容器 Aluminum electrolytic capacitor	片状式 Sheet type	对应完毕 Corresponding to complete	不含 no	不含 no	不含 no	不含 no	不含 no	不含 no	内外包装的 标签上标示 有ROHS Inside and outside the packaging ROHS are marked on the label
	引线式 Radial type	对应完毕 Corresponding to complete	不含 no	不含 no	不含 no	不含 no	不含 no	不含 no	

关于遵守欧洲REACH规定  
About complying with the regulation of European REACH

根据2008年5月26日发布的RIP3.8TGD ( Technical Guidance Document ) 的内容，本公司制造的电子元器件为“无意图发放的成品”，因此不适用欧洲REACH规定的第7条第1项的“注册”条款。

Based on the contents of RIP3.8TGD (Technical Guidance Document) released on May 26, 2008, the company manufacturing the electronic components recognized as “no intention of issuing finished product”, therefore does not apply to the “registered” clause in the item 1 of article 7 of the European REACH regulation.

● 典型故障模式及其主要原因  
Typical failure modes and their factors

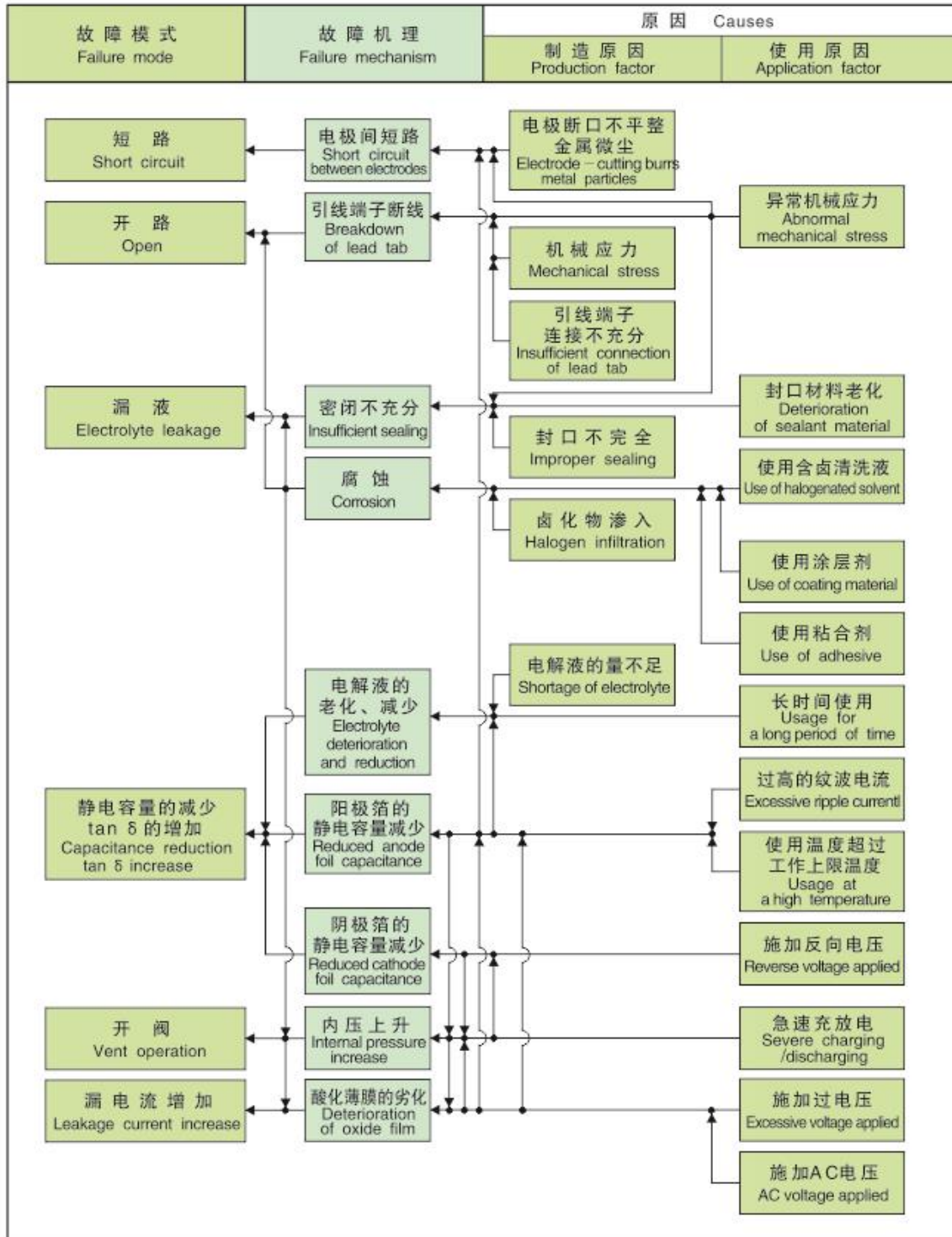

## ● 工艺流程 Process Flow

品质保证  
Quality Control

### 原料 Mateial

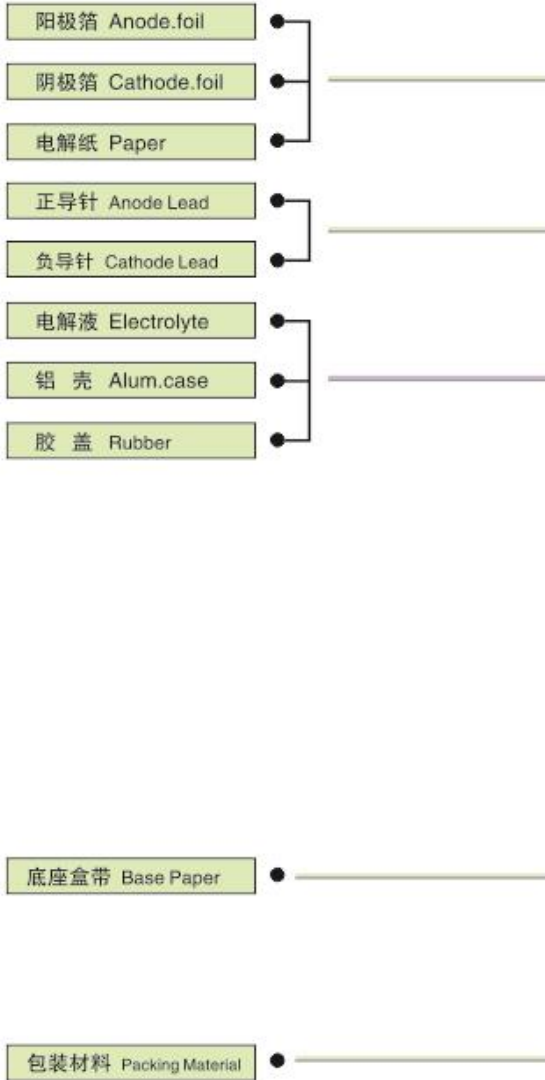

### 制程 Process



● 材料    ● 制程    — QC    ▼ IPQC    ☆ 关键工序

● 客户服务系统图  
Customer service flow chart

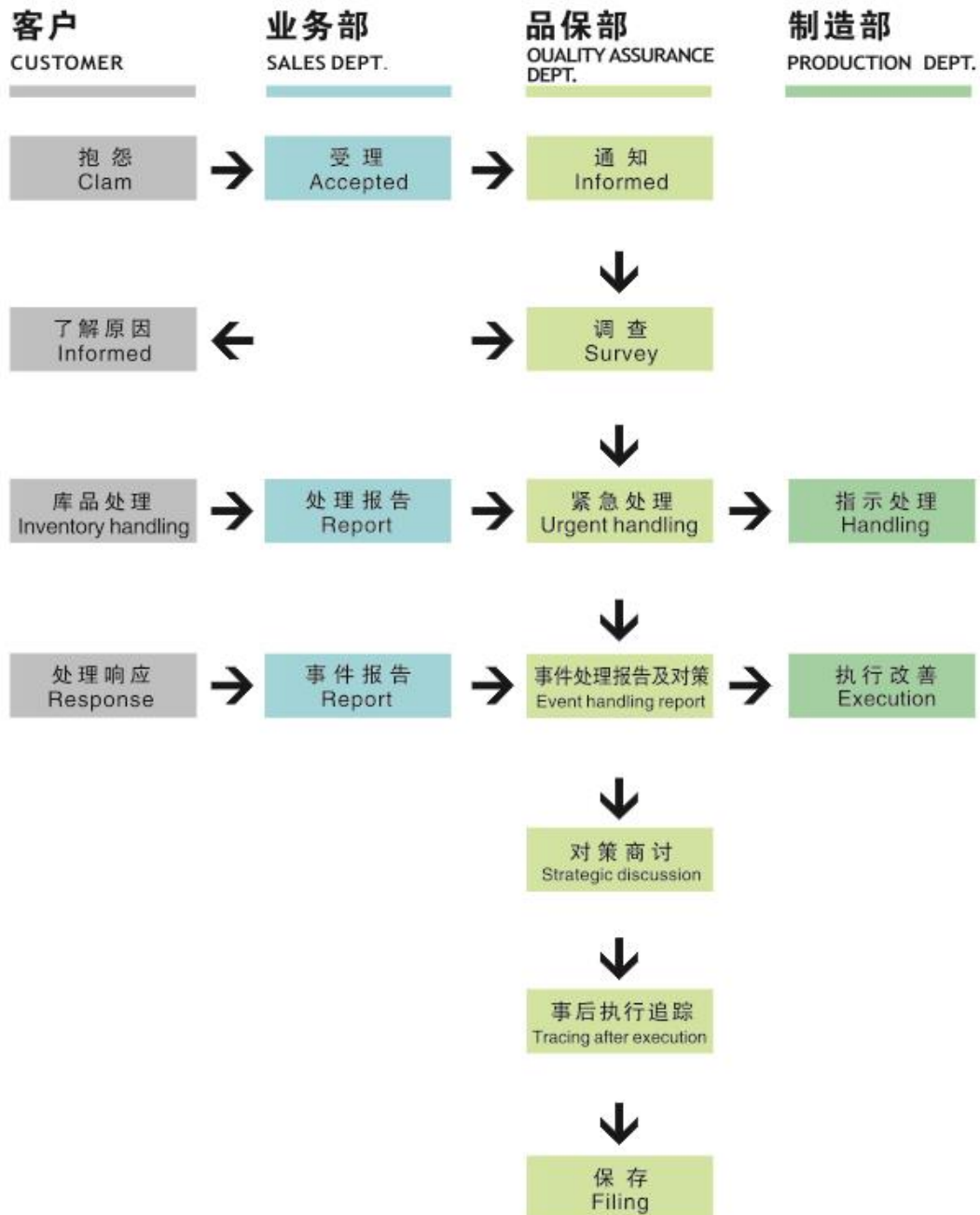

## ● 产品编码解析

### Explanation of Part Number



Series



Rated Voltage

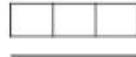

Capacitance



Tol.

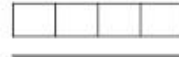

Case Size



Type/Code

Series	R.W Voltage (V)	Code	Capacitance (μF)	Code	Cap.Tol	Code	Case Size	Code	Type	Code		
US	4	0G	0.1	0R1	±5	J	4*5.4	0405	Lead type	EG		
UT	6.3	0J	0.22	R22	±10	K	5*5.4	0505				
UE	10	1A	0.33	R33	±15	L	6.3*5.4	0605				
UZ	16	1C	0.47	R47	±20	M	6.3*7.7	0607				
UN	25	1E	1	010	±30	N	6.3*10.2	0610				
UH	35	1V	1.5	1R5	+20-10	V	8*6.5	0806				
UL	50	1H	2.2	2R2	+20-5	H	8*10.2	0810				
UV	63	1J	3.3	3R3	+10-20	C	8*12.5	0812			Chip type	VG
UD	80	1K	4.7	4R7	+100-0	P	10*10.2	1010				
UW	100	2A	5.6	5R6	+30-10	Q	10*12.5	1012				
	160	2C	6.8	6R8	+20-0	R	10*13.5	1013				
	200	2D	8.2	8R2	+50-10	T	12.5*13.5	1213				
	250	2E	10	100	+75-10	U	12.5*16	1216				
	350	2V	12	120	+40-20	X	16*16.5	1616				
	400	2G	15	150	+50-20	S	16*21.5	1621				
	450	2W	22	220	+80-20	Z	18*16.5	1816				
	500	2H	33	330			18*21.5	1821				
			47	470			20*16.5	2016				
			56	560			20*21.5	2021				
			68	680								
			100	101								
			220	221								
			330	331								
			470	471								
			560	561								
			680	681								
			820	821								
			1000	102								
			1500	152								
			2200	222								
			3300	332								
			4700	472								
			6800	682								

## ● 编带规格/Taping Dimensions

Fig.1 (适用于 $D \leq \Phi 10\text{mm}$ 以下产品)

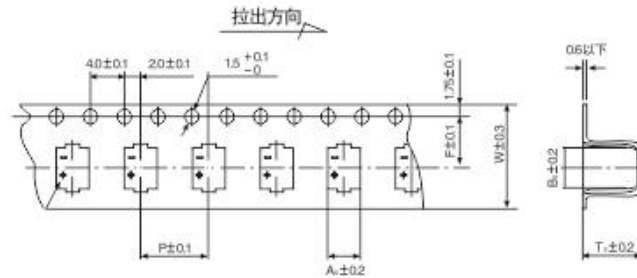
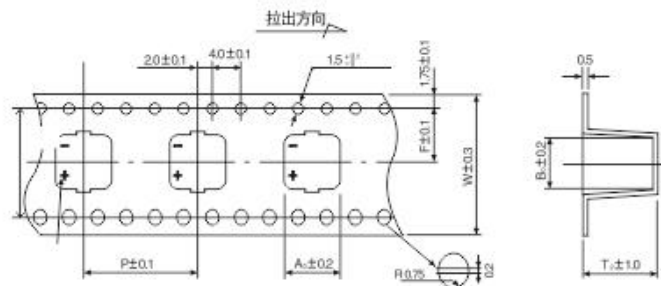

Fig. 2 (适用于 $D \geq \Phi 12.5\text{mm}$ 以上产品)



尺寸 Size	W (MM)	P (MM)	F (MM)	A0 (MM)	B0 (MM)	T2 (MM)	S	形状 Applicable
Φ4*5.4	12	8	5.5	4.7	4.7	5.8	---	Fig.1
Φ5*5.4	12	12	5.5	5.7	5.7	5.8	---	
Φ6.3*5.4	16	12	7.5	7.0	7.0	5.8	---	
Φ6.3*7.7	16	12	7.5	7.0	7.0	8.3	---	
Φ6.3*10.2	16	12	7.5	7.0	7.0	11.0	---	
Φ8*6.5	16	12	7.5	8.7	8.7	6.8	---	
Φ8*10.2	24	16	11.5	8.7	8.7	11.0	---	
Φ8*12.5	24	16	11.5	8.7	8.7	13.0	---	
Φ10*10.2	24	16	11.5	10.7	10.7	11.0	---	
Φ10*12.5	24	16	11.5	10.7	10.7	13.0	---	
Φ10*13.5	24	16	11.5	10.7	10.7	14.1	---	Fig.2
Φ12.5*13.5	32	24	14.2	14.0	14.0	14.1	28.4	
Φ12.5*16	32	24	14.2	14.0	14.0	16.4	28.4	
Φ16*16.5	44	28	20.2	17.5	17.5	16.9	40.4	
Φ16*21.5	44	28	20.2	17.5	17.5	21.9	40.4	
Φ18*16.5	44	32	20.2	19.5	19.5	16.9	40.4	
Φ18*21.5	44	32	20.2	19.5	19.5	21.9	40.4	
Φ20*16.5	44	36	20.2	21.5	21.5	16.9	40.4	
Φ20*21.5	44	36	20.2	21.5	21.5	22.0	40.4	



## ● 卷筒 / Taping Reel And Packing Quantity

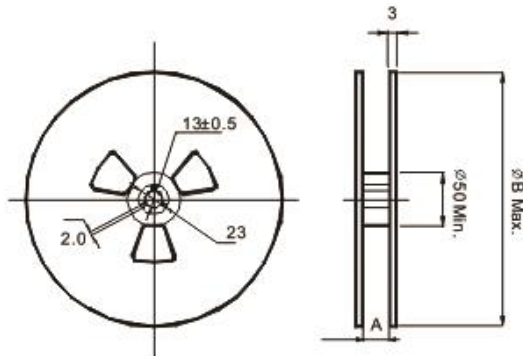

规格 Specification	卷装数量 Quantity/Reel	盒装数量 Quantity/Bag	A ± 0.3 (MM)	B ± 2 (MM)
Φ4*5.4	2000 pcs	20000 pcs	14	382
Φ5*5.4	1000 pcs	10000 pcs	14	382
Φ6.3*5.4	1000 pcs	10000 pcs	18	382
Φ6.3*7.7	1000 pcs	10000 pcs	18	382
Φ6.3*10.2	700 pcs	7000 pcs	18	382
Φ8*6.5	1000 pcs	10000 pcs	18	382
Φ8*10.2	500 pcs	5000 pcs	26	382
Φ8*12.5	400 pcs	4000 pcs	26	382
Φ10*10.2	500 pcs	5000 pcs	26	382
Φ10*12.5	400 pcs	4000 pcs	26	382
Φ10*13.5	300 pcs	3000 pcs	26	382
Φ12.5*13.5	200 pcs	1600 pcs	34	382
Φ12.5*16	200 pcs	1600 pcs	34	382
Φ16*16.5	125 pcs	250 pcs	46	332
Φ16*21.5	75 pcs	150 pcs	46	332
Φ18*16.5	125 pcs	250 pcs	46	332
Φ18*21.5	75 pcs	150 pcs	46	332
Φ20*16.5	100 pcs	200 pcs	46	332
Φ20*21.5	50 pcs	100 pcs	46	332

## ● 焊接方法和再流焊允许范围

Soldering method and allowable range of the reflow

焊接方式 Soldering Method	再流焊的允许范围 Allowable Range of Reflow
热板再流焊 Hot-Plate Reflow	<p>热板再流焊 Hot-Plate Reflow</p>
红外线再流焊 Infrared-Ray Reflow	<p>红外线再流焊 Infrared-Ray Reflow</p>

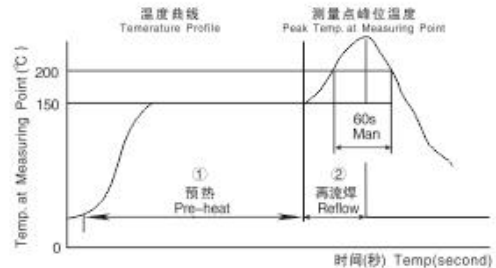

## ● 焊接方法和再流焊允许范围

### Slodering method and allowable rang of the reflow

表一  $\phi 4 \sim \phi 10$ 一般品回流条件:

Table-1  $\phi 4 \sim \phi 10$  general goods reflow condition

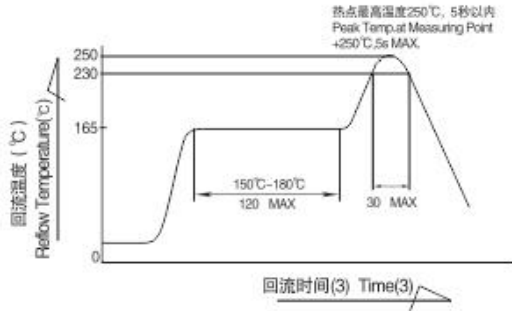

- 预热为150-180°C、120秒以内。  
Pre-heating shall be done at +150°C to 180°C and for 120 seconds.
- 电容器表面温度不可超过250°C。  
The temperature at capacitor Top shall not exceed +250°C.
- 电容器表面的温度超过230°C的时间为30秒以内。  
The duration for over +230°C temperature at capacitor surface shall not exceed 30 seconds.
- 温度分布图的温度标准因回流方式不同而不同。  
The standard temperature profile differs by every reflow method.
- 回流次数最多2次，但在第1次和第2次之间要留出充分的产品冷却时间。  
Reflow shall be done within 2 cycles, please make sure the parts have enough cooling down time between the first and second soldering process.
- 超出容许范围使用时请咨询我们。  
Please contact us if capacitors are subject to the conditions other than the allowable range of reflow.

表二  $\phi 8 * 6.5$ 回流条件:

Table-2  $\phi 8 * 6.5$  reflow condition

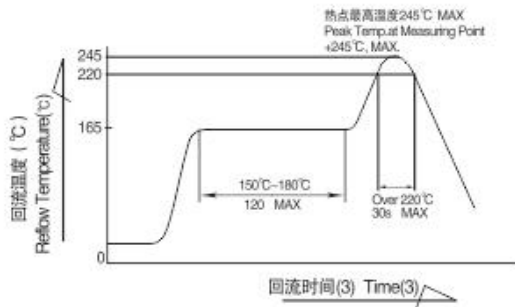

- 预热为150-180°C、120秒以内。  
Pre-heating shall be done at +150°C to 180°C and for 120 seconds.
- 电容器表面温度不可超过245°C。  
The temperature at capacitor Top shall not exceed +245°C.
- 电容器表面的温度超过220°C的时间为30秒以内。  
The duration for over +220°C temperature at capacitor surface shall not exceed 30 seconds.
- 温度分布图的温度标准因回流方式不同而不同。  
The standard temperature profile differs by every reflow method.
- 回流次数最多2次，但在第1次和第2次之间要留出充分的产品冷却时间。  
Reflow shall be done within 2 cycles, please make sure the parts have enough cooling down time between the first and second soldering process.
- 超出容许范围使用时请咨询我们。  
Please contact us if capacitors are subject to the conditions other than the allowable range of reflow.

表三 WV160V-450V 回流条件:

Table-3 WV160V-450V reflow condition

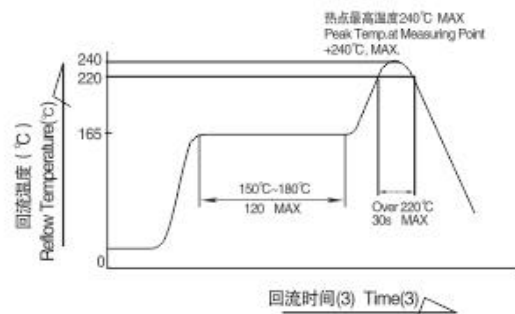

- 预热为150-180°C、120秒以内。  
Pre-heating shall be done at +150°C to 180°C and for 120 seconds.
- 电容器表面温度不可超过240°C。  
The temperature at capacitor Top shall not exceed +240°C.
- 电容器表面的温度超过220°C的时间为30秒以内。  
The duration for over +220°C temperature at capacitor surface shall not exceed 30 seconds.
- 温度分布图的温度标准因回流方式不同而不同。  
The standard temperature profile differs by every reflow method.
- 回流次数最多2次，但在第1次和第2次之间要留出充分的产品冷却时间。  
( $\phi 6.3$ : 仅限1次。)  
Reflow shall be done within 2 cycles, please make sure the parts have enough cooling down time between the first and second soldering process.  
( $\phi 6.3$ : 1 cycle only)
- 超出容许范围使用时请咨询我们。  
Please contact us if capacitors are subject to the conditions other than the allowable range of reflow.

表四  $\phi 12.5 \sim \phi 20$  回流条件:

Table-4  $\phi 12.5 \sim \phi 20$  reflow condition

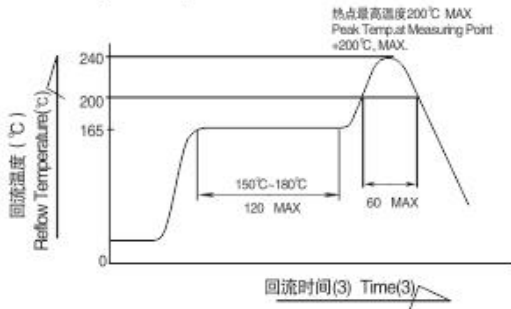

- 预热为150-180℃、120秒以内。  
Pre-heating shall be done at +150℃ to 180℃ and for 120 seconds.
- 电容器表面温度不可超过240℃。  
The temperature at capacitor Top shall not exceed +240℃.
- 电容器表面的温度超过200℃的时间为60秒以内。  
The duration for over +200℃ temperature at capacitor surface shall not exceed 60 seconds.
- 温度分布图的温度标准因回流方式不同而不同。  
The standard temperature profile differs by every reflow method.
- 回流次数最多2次,但在第1次和第2次之间要留出充分的产品冷却时间。  
Reflow shall be done within 2 cycles, please make sure the parts have enough cooling down time between the first and second soldering process.
- 超出容许范围使用时请咨询我们。  
Please contact us if capacitors are subject to the conditions other than the allowable range of reflow.

表五 125℃产品回流条件:

Table-5 125℃ product reflow conditions

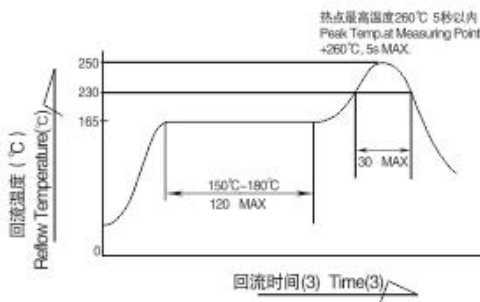

- 预热为150-180℃、120秒以内。  
Pre-heating shall be done at +150℃ to 180℃ and for 120 seconds.
- 电容器表面温度不可超过260℃。  
The temperature at capacitor Top shall not exceed +260℃.
- 电容器表面的温度超过230℃的时间为60秒以内。  
The duration for over +230℃ temperature at capacitor surface shall not exceed 60 seconds.
- 温度分布图的温度标准因回流方式不同而不同。  
The standard temperature profile differs by every reflow method.
- 回流次数最多2次,但在第1次和第2次之间要留出充分的产品冷却时间。  
( $\phi 8 \times 6.5L$ , 仅限1次。)  
Reflow shall be done within 2 cycles, please make sure the parts have enough cooling down time between the first and second soldering process.  
( $\phi 8 \times 6.5L$ , 1 cycle only)
- 超出容许范围使用时请咨询我们。  
Please contact us if capacitors are subject to the conditions other than the allowable range of reflow.

## 表面安装推荐尺寸 Recommended Land Size

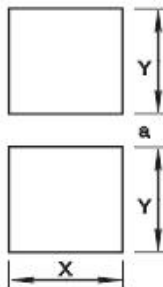

预热进行条件: 不超过+150℃和90秒。

Pre-heating shall be done less than +150℃ and for 90 seconds.

电容器顶部的温度不可超过+260℃。

The temperature at capacitor top shall not exceed +260℃.

电容器顶部的温度在+200℃以上时,持续时间不超过60秒。

The duration for over +200℃ at capacitor top shall not exceed 60 seconds.

不同的再流焊方法,其温度曲线不同。

The standard temperature profile differs by every reflow method.

如果电容器承受的条件与再流焊的允许范围不同,请与我们联系。

If the conditions capacitors can bear are different, from the allowable range of reflow.

尺寸 Size	X	Y	a	尺寸 Size	X	Y	a
$\phi 4$	1.6	2.6	1.0	$\phi 12.5$	4.0	7.5	7.0
$\phi 5$	1.6	3.0	1.4	$\phi 16$	6.0	8.5	9.5
$\phi 6.3$	1.6	3.5	1.9	$\phi 18$	6.0	9.5	10.5
$\phi 8$	2.5	3.5	3.0	$\phi 20$	6.0	9.5	12.5
$\phi 10$	2.5	4.0	4.0				

## 片式铝电解电容器品种一览表

### V-chip Schedule of Aluminum Electrolytic Capacitors Variety

类别 Class	系列 Series	Features 特点	温度(°C) Temperature	额定电压 Rated Voltage (V.DC)	容量Capacitance	寿命 LoadLife	页次 Page
贴片 V-Chip Surface Mount Type	US	标准品 Standard product	-40°C~+85°C	4~100V	0.1μF ~ 2200μF	2000H	19~20
	UT	宽温标准品 Wide temperature standard	-55°C~+105°C	4~100V	0.47μF ~ 1500μF	2000H	21~22
	UE	低阻抗 Low impedance & Low ESR	-55°C~+105°C	6.3~50V	0.1μF ~ 1500μF	2000H	23~24
	UZ	超低阻抗品 Extre lower impedance	-55°C~+105°C	6.3~35V	4.7μF ~ 1500μF	2000H	25~26
	UN	无极性品 Bi-polarized	-55°C~+105°C	6.3~50V	0.1μF ~ 100μF	1000H	27~28
	UL	宽温长寿命品 Wide long life product	-55°C~+105°C	6.3~100V	4.7μF ~ 1500μF	3000~5000H	29~30
	UH	高可靠品 Reliable product	-40°C~+125°C	10~450V	1μF ~ 4700μF	1000~5000H	31~32
	UV	LED 电源驱动经济品 LED power driver-economy goods	-40°C~+105°C	160~450V	1μF ~ 22μF	3000H	33~34
	UD	LED 电源驱动标准品 LED power driver Standard	-40°C~+105°C	160~450V	1μF ~ 22μF	6000H	35~36
	UW	长寿命品 Long life product	-40°C~+105°C	6.3~450V	1μF ~ 1000μF	10000H	37~38



## UT 片式铝电解电容

### UT Chip Type Aluminum Electrolytic Capacitors

#### 产品特点 Features

- 产品直径 Case diameter  $\Phi$  4mm~  $\Phi$  12.5mm
- 性能稳定, 可靠性高 High stability and reliability
- 适用于再回流焊 Reflow soldering is available
- ROHS 指令已对应完毕 Adapted to the RoHS directive
- 适用于高密度表面组装 Available for high density surface mounting
- 寿命105°C 2000 小时标准品 Life time 105°C 2000hrs standard product

#### 主要技术性能 Specifications

项目 Items	特性 Characteristics																																																	
工作温度范围 Category Temperature Range	-55°C~+105°C																																																	
额定电压范围 Rated Voltage Range	4~100V.DC																																																	
标称电容量范围 Nominal Capacitance Range	1 $\mu$ F - 2200 $\mu$ F																																																	
标称电容量允许偏差 Nominal Capacitance Tolerance	$\pm$ 20%(120Hz,+20 °C)																																																	
泄漏电流范围 Leakage Current(MAX)	I=0.01CV( $\mu$ A) or 3 ( $\mu$ A) after 2 minutes I=Leakage Current( $\mu$ A) C=Nominal Capacitance( $\mu$ F) V=Rated Voltage(V)																																																	
损耗角正切值 Dissipation Factor(MAX) Tan $\delta$ (20°C, 120Hz)	<table border="1"> <thead> <tr> <th>Rated Voltage(V)</th> <th>4</th> <th>6.3</th> <th>10</th> <th>16</th> <th>25</th> <th>35</th> <th>50</th> <th>63</th> <th>100</th> </tr> </thead> <tbody> <tr> <td>Tan <math>\delta</math></td> <td>0.35</td> <td>0.30</td> <td>0.24</td> <td>0.20</td> <td>0.18</td> <td>0.16</td> <td>0.14</td> <td>0.14</td> <td>0.14</td> </tr> </tbody> </table>		Rated Voltage(V)	4	6.3	10	16	25	35	50	63	100	Tan $\delta$	0.35	0.30	0.24	0.20	0.18	0.16	0.14	0.14	0.14																												
Rated Voltage(V)	4	6.3	10	16	25	35	50	63	100																																									
Tan $\delta$	0.35	0.30	0.24	0.20	0.18	0.16	0.14	0.14	0.14																																									
耐久性 Load Life	<p>+105°C施加额定工作电压2000H后, 放置16H, 电容器应满足以下要求。 After applying rated voltage with max ripple current for 2000hrs at 105°C, and then resumed 16 hours, the capacitors shall meet the following requirements</p> <table border="1"> <tbody> <tr> <td>Capacitance Change</td> <td><math>\pm</math> 30%初始值以内</td> <td>Within <math>\pm</math> 30% of the initial value</td> </tr> <tr> <td>Dissipation Factor</td> <td><math>\leq</math> 200%初始值以内</td> <td>Not more than 200% of the specified value</td> </tr> <tr> <td>Leakage Current</td> <td><math>\leq</math> 初始规定值</td> <td>Not more than the specified value</td> </tr> </tbody> </table>		Capacitance Change	$\pm$ 30%初始值以内	Within $\pm$ 30% of the initial value	Dissipation Factor	$\leq$ 200%初始值以内	Not more than 200% of the specified value	Leakage Current	$\leq$ 初始规定值	Not more than the specified value																																							
Capacitance Change	$\pm$ 30%初始值以内	Within $\pm$ 30% of the initial value																																																
Dissipation Factor	$\leq$ 200%初始值以内	Not more than 200% of the specified value																																																
Leakage Current	$\leq$ 初始规定值	Not more than the specified value																																																
高温贮存 Shelf Life	<p>+105°C, 贮存1000H后, 放置16H, 电容器应满足以下要求。 After storage for 1000hrs at 105°C, then resumed 16 hours, the capacitors shall meet the following requirements</p> <table border="1"> <tbody> <tr> <td>Capacitance Change</td> <td><math>\pm</math> 30%初始值以内</td> <td>Within <math>\pm</math> 30% of the initial value</td> </tr> <tr> <td>Dissipation Factor</td> <td><math>\leq</math> 200%初始值以内</td> <td>Not more than 200% of the specified value</td> </tr> <tr> <td>Leakage Current</td> <td><math>\leq</math> 300%初始值以内</td> <td>Within 300% of initial specified value</td> </tr> </tbody> </table>		Capacitance Change	$\pm$ 30%初始值以内	Within $\pm$ 30% of the initial value	Dissipation Factor	$\leq$ 200%初始值以内	Not more than 200% of the specified value	Leakage Current	$\leq$ 300%初始值以内	Within 300% of initial specified value																																							
Capacitance Change	$\pm$ 30%初始值以内	Within $\pm$ 30% of the initial value																																																
Dissipation Factor	$\leq$ 200%初始值以内	Not more than 200% of the specified value																																																
Leakage Current	$\leq$ 300%初始值以内	Within 300% of initial specified value																																																
耐焊接热 Resistance to Soldering Heat	<p>在250°C的条件下, 电容器在热板上保持30秒, 然后从热板上取出电容器, 让其在室温下恢复, 电容器应满足以下要求。 The capacitors shall be kept on then hot plate maintained at 250°C for 30 seconds. After removing from the hot plate and restored at room temperature, they meet the following requirement:</p> <table border="1"> <tbody> <tr> <td>Capacitance Change</td> <td><math>\pm</math> 10%初始值以内</td> <td>Within <math>\pm</math> 10% of the initial value</td> </tr> <tr> <td>Dissipation Factor</td> <td><math>\leq</math> 初始规定值</td> <td>Not more than the initial specified value</td> </tr> <tr> <td>Leakage Current</td> <td><math>\leq</math> 初始规定值</td> <td>Not more than the initial specified value</td> </tr> </tbody> </table>		Capacitance Change	$\pm$ 10%初始值以内	Within $\pm$ 10% of the initial value	Dissipation Factor	$\leq$ 初始规定值	Not more than the initial specified value	Leakage Current	$\leq$ 初始规定值	Not more than the initial specified value																																							
Capacitance Change	$\pm$ 10%初始值以内	Within $\pm$ 10% of the initial value																																																
Dissipation Factor	$\leq$ 初始规定值	Not more than the initial specified value																																																
Leakage Current	$\leq$ 初始规定值	Not more than the initial specified value																																																
低温特性及阻抗比 Low Temperature Stability Impedance Ratio (MAX) 120Hz	<table border="1"> <thead> <tr> <th>Rated Voltage (V)</th> <th>4</th> <th>6.3</th> <th>10</th> <th>16</th> <th>25</th> <th>35</th> <th>50</th> <th>63</th> <th>100</th> </tr> </thead> <tbody> <tr> <td rowspan="2">Z-25°C/Z+20°C (120Hz)</td> <td>&lt; <math>\Phi</math>8</td> <td>7</td> <td>4</td> <td>3</td> <td>2</td> <td>2</td> <td>2</td> <td>2</td> <td>2</td> </tr> <tr> <td><math>\geq</math> <math>\Phi</math>8</td> <td>7</td> <td>5</td> <td>4</td> <td>3</td> <td>2</td> <td>2</td> <td>2</td> <td>2</td> </tr> <tr> <td rowspan="2">Z-40°C/Z+20°C (120Hz)</td> <td>&lt; <math>\Phi</math>8</td> <td>15</td> <td>8</td> <td>8</td> <td>4</td> <td>4</td> <td>3</td> <td>3</td> <td>3</td> </tr> <tr> <td><math>\geq</math> <math>\Phi</math>8</td> <td>15</td> <td>10</td> <td>8</td> <td>6</td> <td>4</td> <td>3</td> <td>3</td> <td>3</td> </tr> </tbody> </table>		Rated Voltage (V)	4	6.3	10	16	25	35	50	63	100	Z-25°C/Z+20°C (120Hz)	< $\Phi$ 8	7	4	3	2	2	2	2	2	$\geq$ $\Phi$ 8	7	5	4	3	2	2	2	2	Z-40°C/Z+20°C (120Hz)	< $\Phi$ 8	15	8	8	4	4	3	3	3	$\geq$ $\Phi$ 8	15	10	8	6	4	3	3	3
Rated Voltage (V)	4	6.3	10	16	25	35	50	63	100																																									
Z-25°C/Z+20°C (120Hz)	< $\Phi$ 8	7	4	3	2	2	2	2	2																																									
	$\geq$ $\Phi$ 8	7	5	4	3	2	2	2	2																																									
Z-40°C/Z+20°C (120Hz)	< $\Phi$ 8	15	8	8	4	4	3	3	3																																									
	$\geq$ $\Phi$ 8	15	10	8	6	4	3	3	3																																									
其它 Other	IEC 60384 JIS-C5101																																																	

■ 尺寸图 Dimensions

Fig. 1 (Φ4~Φ10)

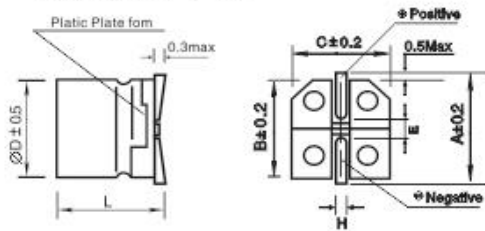
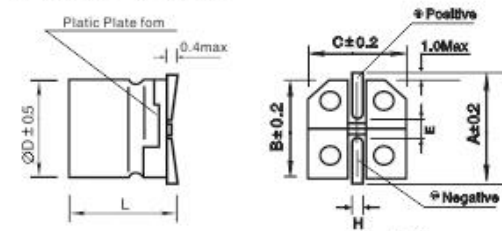

Fig. 2 (≥ Φ12.5)



单位: mm

ΦD	L	A	B	C	E	H	Fig.No.
4	5.4 ± 0.3	5.0	4.3	4.3	1.0	0.5~0.9	1
5	5.4 ± 0.3	6.0	5.3	5.3	1.5	0.5~0.9	1
6.3	5.4 ± 0.3	7.2	6.6	6.6	2.1	0.5~0.9	1
6.3	7.7 ± 0.3	7.2	6.6	6.6	2.1	0.5~0.9	1
8	6.5 ± 0.5	9.1	8.3	8.3	3.1	0.8~1.1	1
8	10.2 ± 0.5	9.1	8.3	8.3	3.1	0.8~1.1	1
10	10.2 ± 0.5	11.1	10.3	10.3	4.5	0.8~1.1	1
12.5	13.5 ± 0.5	13.7	13.0	13.0	4.4	1.0~1.4	2

■ 标准品一览表 Standard Size

V	6.3		10		16		25		35		50		63		100	
μF	D×Lmm	mA	D×Lmm	mA	D×Lmm	mA	D×Lmm	mA	D×Lmm	mA	D×Lmm	mA	D×Lmm	mA	D×Lmm	mA
1											4×5.4	8.0	4×5.4	7.2	4×5.4	7.2
2.2											4×5.4	12	4×5.4	12	6.3×5.4	15
3.3									4×5.4	14	4×5.4	14	5×5.4	14	6.3×5.4	22
4.7							4×5.4	14	4×5.4	15	5×5.4	17	6.3×5.4	22	6.3×7.7	38
10					4×5.4	17	4×5.4	15	4×5.4	15	5×5.4	23	6.3×5.4	26	6.3×7.7	38
22	4×5.4	22	4×5.4	21	4×5.4	21	5×5.4	26	5×5.4	30	6.3×5.4	43	6.3×7.7	53	8×10.2	90
33	4×5.4	23	4×5.4	23	5×5.4	29	5×5.4	30	6.3×5.4	45	6.3×7.7	63	8×10.2	116	10×10.2	136
47	4×5.4	26	5×5.4	31	5×5.4	33	6.3×5.4	49	6.3×5.4	54	6.3×7.7	66	8×10.2	125	10×10.2	148
100	5×5.4	40	5×5.4	40	6.3×5.4	63	6.3×7.7	93	6.3×7.7	75	8×10.2	146	10×10.2	168	125×13.5	276
220	6.3×5.4	52	6.3×5.4	55	6.3×7.7	72	8×10.2	183	8×10.2	195	10×10.2	230	125×13.5	380		
330	6.3×5.4	69	6.3×5.4	78	6.3×7.7	110	10×10.2	247	10×10.2	230	125×13.5	360				
470	6.3×7.7	108	8×10.2	108	8×10.2	201	8×10.2	228	10×10.2	247	125×13.5	360				
680	6.3×7.7	125	6.3×7.7	160	8×10.2	240	10×10.2	286	10×10.2	286						
1000	8×10.2	214	8×10.2	214	10×10.2	300	12.5×13.5	440	12.5×13.5	440						
1500	8×10.2	235	10×10.2	320	10×10.2	347	12.5×13.5	500								
2200	10×10.2	320	12.5×13.5	540	12.5×13.5	540										
	12.5×13.5	600	12.5×13.5	600												

mA额定纹波电流 Rated ripple current(mA, 105°C, 120Hz)

■ 纹波电流修正系数 Multiplier For Ripple Current

● 频率系数 Frequency coefficient

频率 Frequency	50Hz	120Hz	300Hz	1kHz	≥10kHz
系数 Coefficient	0.70	1.00	1.17	1.36	1.50

注: 以上所提供的设计及特性参数仅供参考, 任何修改不做预先通知, 如在使用上有疑问, 请在采购前与我们联系, 以便提供技术上的协助。  
Note: all designs and specifications are for reference only and are subject to change without prior notice, if any doubt about safety for your application, please contact us immediately for technical assistance before purchase.

## 铝电解电容器相关知识

### 1. 忽略纹波电流时的寿命推算

一般而言，铝电解电容器的寿命与周围的环境温度有很大的关系，其寿命可以由以下公式计算：

$$L = L_0 \times 2^{\frac{T_0 - T}{10}} \dots\dots\dots (1)$$

其中，L: 温度T时的寿命  
L<sub>0</sub>: 温度T<sub>0</sub>时的寿命

与温度比较，降压使用对电容器的寿命影响很小，可忽略不计。

### 2. 考虑纹波电流时寿命的推算

叠加纹波电流，由于内部等效串联电阻(ESR)引起发热，从而影响电容器的使用寿命，产生的热量可由下公式计算

$$P = I^2 R \dots\dots\dots (2)$$

其中，I: 纹波电流(Arms)  
R: 等效串联电阻(Ω)  
其中，ΔT: 电容器中心的温升(°C)  
I: 纹波电流(Arms)  
R: ESR(Ω)  
A: 电容器的表面积(cm<sup>2</sup>)  
H: 散热系数(1.5~2.0×10<sup>-3</sup>W/cm<sup>2</sup>×°C)

由于发热引起的温升 
$$\Delta T = \frac{I^2 R}{A \cdot H} \dots\dots\dots (3)$$

上面公式(3)显示电容器的温度上升与纹波电流的平方以及等效串联电阻ESR成正比，与电容器的表面积成反比，因此，纹波电流的大小决定着产生热量的大小，且影响其使用寿命，电容器的类型以及使用条件影响着ΔT值的大小，一般情况下ΔT < 5°C，下图表示纹波电流引起的温升的测量点



测试结果:

#### (1) 考虑到环境温度和纹波电流时的寿命公式

$$L = L_0 \times 2^{\frac{T_0 - T}{10}} \times K^{\frac{-\Delta T}{10}} \dots\dots\dots (4)$$

其中，L<sub>0</sub>: 直流工作电压下的使用寿命  
(K=2, 纹波电流允许的范围)  
(k=4, 超过纹波电流范围时)  
T<sub>0</sub>: 最高使用温度  
T: 工作温度  
ΔT: 中心温升

#### (2) 电容器工作在额定的纹波电流和上限温度时，电容器的寿命可通过转化(4)式得到，如下：

$$L = L_0 \times 2^{\frac{T_0 - T}{10}} \times K^{\frac{\Delta T_0 - \Delta T}{10}} \dots\dots\dots (5)$$

其中，L<sub>0</sub>: 工作在额定纹波电流和最高工作温度下的寿命(h)  
ΔT<sub>0</sub>: 最高工作温度下的电容器中心容许温升。

#### (3) 考虑纹波电流，环境温度时可由(5)式得到下式

$$L = L_0 \times 2^{\frac{T_0 - T}{10}} \times K^{\left[1 - \left(\frac{I}{I_0}\right)^2\right]} \times \frac{\Delta T_0}{10} \dots\dots\dots (6)$$

其中，L<sub>0</sub>: 最高工作温度下的额定纹波电流(Arms)  
I: 叠加的纹波电流(Arms)

由于直接测量电容器的内部温升存在着困难，下表列出了表面温度和内部核心温度的换算关系。

直径	~10	12.5~14	16	22	25	30	35
中心/表面	1.1	1.2	1.25	1.3	1.4	1.6	1.65

寿命的推算公式，原则上适用于周围环境温度为+40°C最高工作温度范围内，但由于封口材料的老化等因素，实际的推算寿命时间一般最大为15年。

(图2-1寿命推算曲线)

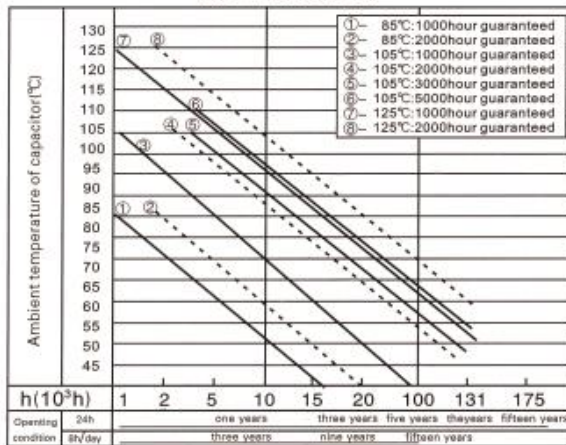

## X-ON Electronics

Largest Supplier of Electrical and Electronic Components

*Click to view similar products for [Aluminium Electrolytic Capacitors - SMD category](#):*

*Click to view products by [Cotronic manufacturer](#):*

Other Similar products are found below :

[GA0402A270FXBAC31G](#) [RVB-50V330MG10UQ-R](#) [RVJ-50V101MH10U-R](#) [RVZ-35V151MH10U-R2](#) [RC0J226M04005VR](#)  
[RC0J476M05005VR](#) [RC1A227M08010VR](#) [RC1C226M05005VR](#) [RC1C476M6L005VR](#) [RC1E107M6L07KVR](#) [RC1E336M6L005VR](#)  
[RC1H106M6L005VR](#) [RC1H475M05005VR](#) [RC1V227M10010VR](#) [RC1V476M6L006VR](#) [50SEV1M4X5.5](#) [TYEH1A336E55MTR](#)  
[TYEH1H106F55MTR](#) [TYEH1V106E55MTR](#) [35SEV47M6.3X8](#) [35SGV220M10X10.5](#) [VES2R2M1HTR-0405](#) [VZH102M1ATR-1010](#)  
[50SEV10M6.3X5.5](#) [50SGV1M4X6.1](#) [SC1C476M05005VR](#) [SC1E107M0806BVR](#) [SC1E227M08010VR](#) [SC1H106M05005VR](#)  
[SC1H106M6L005VR](#) [SC1H227M10010VR](#) [SC1H335M04005VR](#) [CE4.7/50-SMD](#) [VEJ4R7M1VTR-0406](#) [VZH331M1ETR-0810](#)  
[VES101M1CTR-0605](#) [TYEH1H475E55MTR](#) [6.3SEV22M4X5.5](#) [6.3SEV47M4X5.5](#) [EEEFK1H151GP](#) [EEEFK1A681GP](#) [EEE0GA471XP](#)  
[EEEFK1V151GP](#) [RC1V107M6L07KVR](#) [VZH101M1VTR-0810](#) [VE010M1HTR-0405](#) [GYA1V151MCQ1GS](#) [EEH-ZC1J680P](#) [EEH-](#)  
[ZK1V181P](#) [GYA1V271MCQ1GS](#)