

<p>深圳市新天源电子有限公司</p> <p>Shenzhen Xintianyuan Electronics Co., Ltd.</p>	<p>石英晶体谐振器规格书</p> <p>Specification of Quartz Crystal</p>	<p>NO: XTY0292-7079</p>
	<p>无源 SMD3225 4pin</p>	<p>Date: 2019/06/27</p>
<p>一、石英晶体规格参数</p> <p>Quartz Crystal Specification Parameters</p>		
<p>1、产品型号</p> <p>Holder Type</p>	<p>SMD 3225 (4pin)</p>	
<p>2、标称频率</p> <p>Nominal Frequency</p>	<p>26.000000MHz</p>	
<p>3、振动模式：</p> <p>Mode of Oscillation</p>	<p>Fundamental</p>	
<p>4、调整频差</p> <p>Frequency Tolerance at 25°C ±2°C</p>	<p>±10ppm at 25°C ±2°C</p>	
<p>5、等效电阻</p> <p>Equivalent Resistance(ESR)</p>	<p>≤40 Ω</p>	
<p>6、负载电容</p> <p>Load Capacitance(CL)</p>	<p>16pF</p>	
<p>7、温度频差</p> <p>Temperature Characteristics</p>	<p>±20ppm</p>	
<p>8、工作温度范围</p> <p>Operating Temperature range</p>	<p>-40~+85°C</p>	
<p>9、储存温度范围</p> <p>Storage Temperature range</p>	<p>-55~+125°C</p>	
<p>10、激励功率</p> <p>Drive Level</p>	<p>100uW</p>	
<p>11、静态电容</p> <p>Shunt Capacitance (C0)</p>	<p><4.0pF</p>	
<p>12、绝缘电阻</p> <p>Insulation Resistance</p>	<p>≥500MΩ (DC100V ±15V)</p>	
<p>13、测试仪器</p> <p>Measure Instrument</p>	<p>250B</p>	
<p>14、年老化率</p> <p>Aging Rate a Year</p>	<p>≤±3ppm/年</p>	

深圳市新天源电子有限公司 Shenzhen Xintianyuan Electronics Co., Ltd.	石英晶体谐振器规格书 Specification of Quartz Crystal	NO: XTY0292-7079
	无源 SMD3225 4pin	Date: 2019/06/27

二、石英晶体尺寸、结构

Quartz Crystal Dimensions And Structure

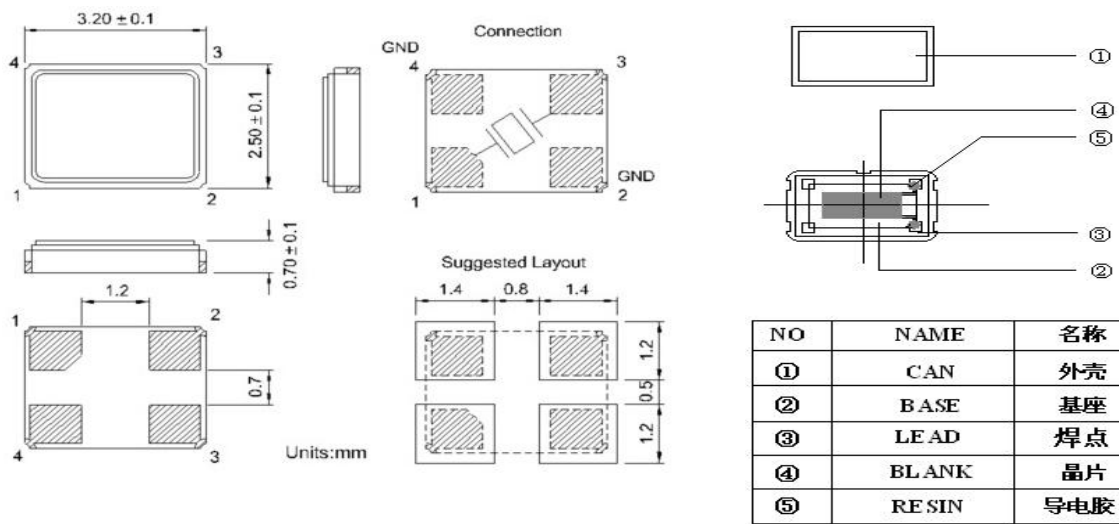

三、石英晶体印字

Quartz Crystal Marking



印字: Marking

XTY: 新天源

Y为年(year): 8:2018; 9:2019...

M为月(Month): A:1; B:2...

P为负载 CL:20: 20pF

FF. FFFM为频率Frequency: 27.000M

例8C20: 8为2018年, C为3月, 20为20pF;

年、月、负载代码:

年	2015	2016	2017	2018	2019	2020	2021	2022	2023	2024	2025	2026
代码	5	6	7	8	9	0	1	2	3	4	5	6
月	1	2	3	4	5	6	7	8	9	10	11	12
代码	A	B	C	D	E	F	G	H	I	J	K	L
负载	9pF	10pF	11pF	12pF	13pF	14pF	15pF	16pF	17pF	18pF	19pF	SERIES
代码	9	10	11	12	13	14	15	16	17	18	19	S

深圳市新天源电子有限公司 Shenzhen Xintianyuan Electronics Co., Ltd.	石英晶体谐振器规格书 Specification of Quartz Crystal	NO: XTY0292-7079
	无源 SMD3225 4pin	Date: 2019/06/27

四、包装要求 Packaging

1. 编带 Tape



Type	W	E	F	T	P	P0	P2	D0	D1	A0	KO	B0
SMD 3225	8.00	1.75	3.50	0.25	4.00	4.00	2.00	∅1.5	∅1.0	2.75	0.95	3.50

Unit: mm

2. 轮 Reel

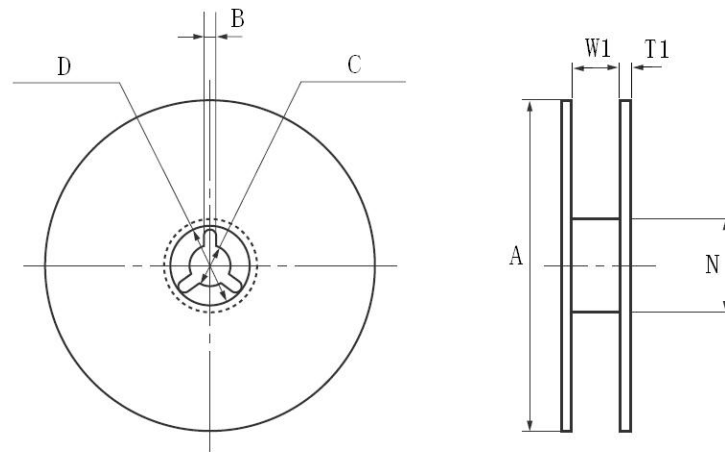

Type	A	B	C	D	N	W1	T1
SMD 3225	∅178	2.5	∅13	∅22.2	∅60	8.5	1.0

Unit: mm

深圳市新天源电子有限公司 Shenzhen Xintianyuan Electronics Co.,Ltd.	石英晶体谐振器规格书 Specification of Quartz Crystal	NO: XTY0292-7079
	无源 SMD3225 4pin	Date: 2019/06/27

3. 包装
Package

3000只/1卷
3000pcs/Reel



1轮=1盒
1Reel=1Box
Units: mm

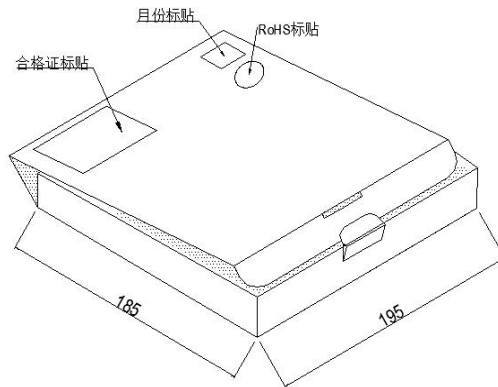

合格证	
频率:	型号:
负载:	电阻:
频差:	数量:
日期:	供应商:
批号:	编号:
订单号:	料号:

包装箱
Shipping Carton

40*34*21.5 (20 Box)
27*20*32.2 (12 Box)
27*20*20 (8 Box)
Units: cm



深圳市新天源电子有限公司 Shenzhen Xintianyuan Electronics Co., Ltd.	石英晶体谐振器规格书 Specification of Quartz Crystal	NO: XTY0292-7079
	无源 SMD3225 4pin	Date: 2019/06/27

五、石英晶体可靠性
Reliability Test

NO.	测试项目 Test Item	可靠性条件 Testing Condition	判定标准 Determinant Criteria
1.	跌落 Dropping Test	从75cm高度跌落到30mm厚硬木板上，跌落三次 Drop the resonators from 75cm height to 30mm thick hardwood board, 3times.	$\Delta FL \leq \pm 5\text{ppm}$ $\Delta RS \leq \pm 10\%$ or $5\ \Omega$ (whichever is larger)
2.	振动 Vibration	频率 Frequency:10~60Hz; 幅度 Amplitude:0.75mm; 周期 Cycle time:10-55-10Hz: 1min; 振动方向 Direction:X, Y, Z; 振动时间 Duration: 每个方向2小时 2 h/direction.	$\Delta FL \leq \pm 5\text{ppm}$ $\Delta RS \leq \pm 10\%$ or $5\ \Omega$ (whichever is larger)
3.	高温 Heat Resistance	温度Temperature: $125^\circ\text{C} \pm 10^\circ\text{C}$ 时间Time: 720 ± 24 Hours	$\Delta FL \leq \pm 5\text{ppm}$ $\Delta RS \leq \pm 10\%$ or $5\ \Omega$ (whichever is larger)
4.	低温 Cold Resistance	温度Temperature: $-40^\circ\text{C} \pm 10^\circ\text{C}$ 时间Time: 720 ± 24 Hours	$\Delta FL \leq \pm 5\text{ppm}$ $\Delta RS \leq \pm 10\%$ or $5\ \Omega$ (whichever is larger)
5.	回流焊 (2次) Reflow (2times)	 <p>回流焊Reflow $260^\circ\text{C} \pm 5^\circ\text{C} \leq 10\text{s}$</p>	$\Delta FL \leq \pm 5\text{ppm}$ $\Delta RS \leq \pm 10\%$ or $5\ \Omega$ (whichever is larger)
6.	耐焊接热 Resistance To Soldering Heat	焊接温度Soldering Heat: $320^\circ\text{C} \pm 10^\circ\text{C}$ 测试时间Test Time: $3.5\text{s} \pm 0.5\text{s}$;	$\Delta FL \leq \pm 5\text{ppm}$ $\Delta RS \leq \pm 10\%$ or $5\ \Omega$ (whichever is larger)
7.	气密性 Leakage	用氦质谱仪进行检测，试验气体: He; 真空度: $1 \times 10^{-3}\text{Pa}$; Helium mass-mass-spectrometer detector, and vacuum and reach $1 \times 10^{-3}\text{Pa}$;	$\leq 1 \times 10^{-8}\text{atm} \cdot \text{cc/S}$
8.	高温高湿 Constant Temperature and Humidity	在温度 $60^\circ\text{C} \pm 5^\circ\text{C}$ ，湿度90%~99%，储存720小时，取出2小时后测试; Stored at $60^\circ\text{C} \pm 5^\circ\text{C}$, Humidity 90%~99% For a period of minimum 720hours. Then $25^\circ\text{C} \pm 3^\circ\text{C}$ and 2 hours before testing	$\Delta FL \leq \pm 5\text{ppm}$ $\Delta RS \leq \pm 10\%$ or $5\ \Omega$ (whichever is larger) Appearance OK
9.	温度冲击 Temperature Shock	低温Low $-40^\circ\text{C} \pm 2^\circ\text{C}$ (120min) \leftrightarrow 高温High $85^\circ\text{C} \pm 2^\circ\text{C}$ (120min); 循环10次; For 10 cycles	$\Delta FL \leq \pm 5\text{ppm}$ $\Delta RS \leq \pm 10\%$ or $5\ \Omega$ (whichever is larger)

X-ON Electronics

Largest Supplier of Electrical and Electronic Components

Click to view similar products for [Crystals](#) category:

Click to view products by [XTY](#) manufacturer:

Other Similar products are found below :

[CS325S24000000ABJT](#) [718-13.2-1](#) [MC405 32.0000K-R3:PURE SN](#) [FC-135R 32.7680KF-A3](#) [7A-40.000MAAE-T](#) [7B-27.000MBBK-T](#)
[FL2000085](#) [9B-15.360MBBK-B](#) [9C-7.680MBBK-T](#) [ASH7K-32.768KHZ](#) [AT-41.600MAGQ-T](#) [BTD1062E05A-513](#) [LFX TAL066198Cutt](#)
[9C-14.31818MBBK-T](#) [FA-238 50.0000MB30X-K3](#) [FC-12M 32.7680KA-AC3](#) [SSPT7F-9PF20-R](#) [FX325BS-38.88EEM1201](#)
[LFX TAL065253Cutt](#) [LFX TAL066431Cutt](#) [XT9S20ANA14M7456](#) [XT9SNLANA16M](#) [646G-24-2](#) [7A-24.576MBBK-T](#) [7B-30.000MBBK-T](#)
[WX26-32.768K-6PF](#) [9B-14.31818MBBK-B](#) [CD1AM](#) [7B-25.000MAAE-T](#) [7A-14.31818MBBK-T](#) [6504-202-1501](#) [6526-202-1501](#) [FA-118T](#)
[27.1200MB50P-K0](#) [FC-135R 32.7680KA-A3](#) [ABM12-104-37.400MHZT](#) [ABLS-10.000MHZ-D3W-T](#) [BTJ112E01E-513](#) [BTJ722K01C-7067](#)
[BTL-20-513](#) [TSX-3225 24.0000MF15X-AC](#) [TSX-3225 16.0000MF18X-AC](#) [BTJ120E02C](#) [BTL-12-513](#) [7A-10.000MBBK-T](#) [7A-](#)
[11.0592MBBK-T](#) [ABM12-103-24.000MHZT](#) [CS325S25000000ABJT](#) [ABM3B-25.000MHZ-B2-X-T](#) [FC-135 32.7680KA-A5](#) [FX0800015](#)