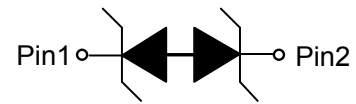

ESD5451N
1-Line, Bi-directional, Transient Voltage Suppressors
<http://www.sh-willsemi.com>
Descriptions

The ESD5451N is a bi-directional TVS (Transient Voltage Suppressor). It is specifically designed to protect sensitive electronic components which are connected to low speed data lines and control lines from over-stress caused by ESD (Electrostatic Discharge), EFT (Electrical Fast Transients) and Lightning.

The ESD5451N may be used to provide ESD protection up to $\pm 30\text{kV}$ (contact and air discharge) according to IEC61000-4-2, and withstand peak pulse current up to 8A (8/20 μs) according to IEC61000-4-5.

The ESD5451N is available in DFN1006-2L package. Standard products are Pb-free and Halogen-free.

DFN1006-2L (Bottom View)

Circuit diagram
Features

- Reverse stand-off voltage: $\pm 5\text{V}$ Max
- Transient protection for each line according to IEC61000-4-2 (ESD): $\pm 30\text{kV}$ (contact and air discharge)
IEC61000-4-4 (EFT): 40A (5/50ns)
IEC61000-4-5 (surge): 8A (8/20 μs)
- Capacitance: $C_J = 17.5\text{pF}$ typ.
- Low leakage current: $I_R < 1\text{nA}$ typ.
- Low clamping voltage: $V_{CL} = 9\text{V}$ typ. @ $I_{PP} = 16\text{A}$ (TLP)
- Solid-state silicon technology



2 = Device code

* = Month code (A~Z)

Marking (Top View)
Applications

- Cellular handsets
- Tablets
- Laptops
- Other portable devices
- Network communication devices

Order information

Device	Package	Shipping
ESD5451N-2/TR	DFN1006-2L	10000/Tape&Reel

Absolute maximum ratings

Parameter	Symbol	Rating	Unit
Peak pulse power ($t_p = 8/20\mu s$)	P_{pk}	80	W
Peak pulse current ($t_p = 8/20\mu s$)	I_{PP}	8	A
ESD according to IEC61000-4-2 air discharge	V_{ESD}	± 30	kV
ESD according to IEC61000-4-2 contact discharge		± 30	
Operation junction temperature	T_J	125	$^{\circ}C$
Lead temperature	T_L	260	$^{\circ}C$
Storage temperature	T_{STG}	-55~150	$^{\circ}C$

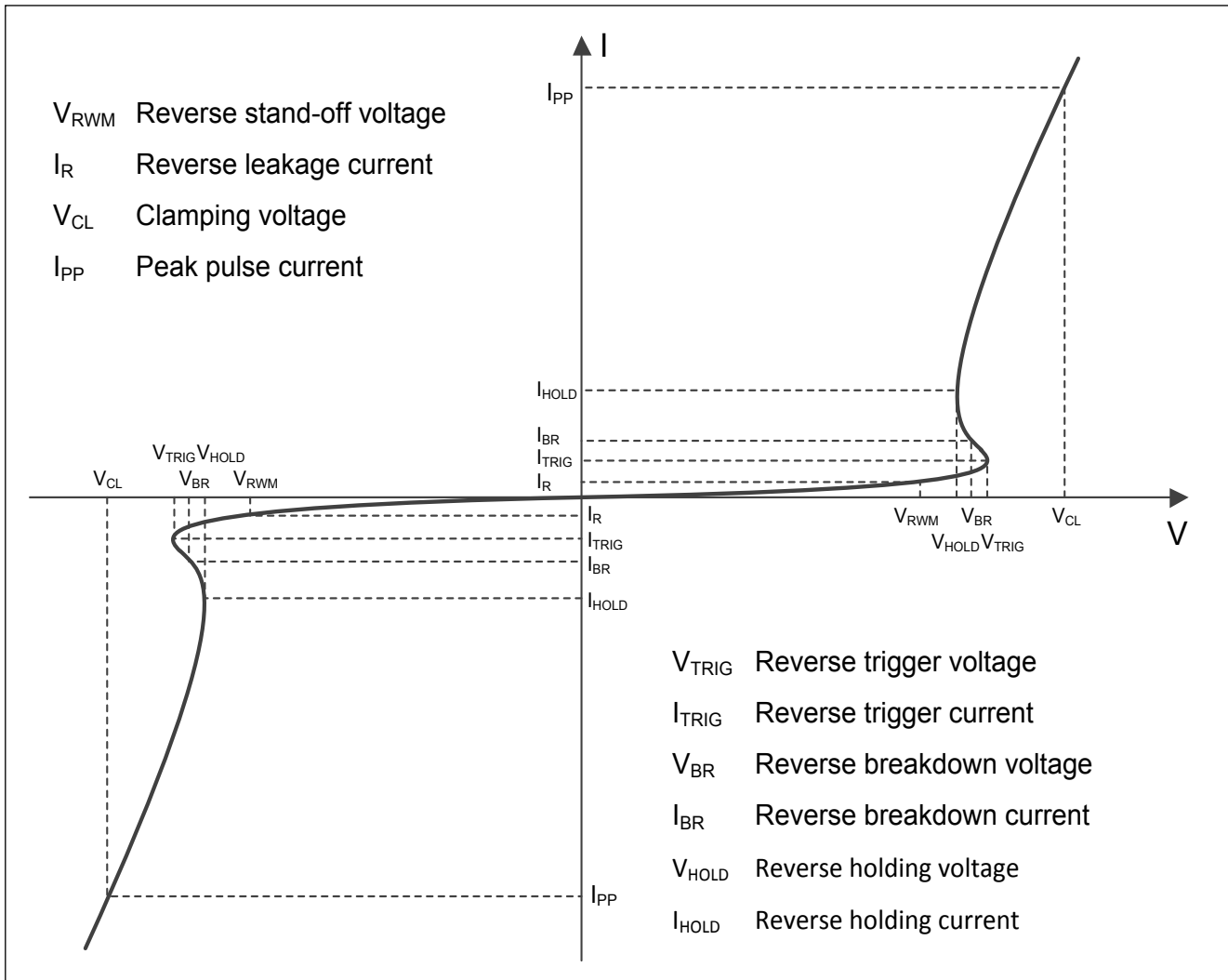
Electrical characteristics ($T_A=25^{\circ}C$, unless otherwise noted)

Definitions of electrical characteristics

Electrical characteristics (T_A=25 °C, unless otherwise noted)

Parameter	Symbol	Condition	Min.	Typ.	Max.	Unit
Reverse stand-off voltage	V _{RWM}				±5	V
Reverse leakage current	I _R	V _{RWM} = 5V		<1	100	nA
Reverse breakdown voltage	V _{BR}	I _{BR} = 1mA	5.1			V
Reverse holding voltage	V _{HOLD}	I _{HOLD} = 50mA	5.1			V
Clamping voltage ¹⁾	V _{CL}	I _{PP} = 16A, t _p = 100ns		9		V
Clamping voltage ²⁾	V _{CL}	V _{ESD} = 8kV		9		V
Clamping voltage ³⁾	V _{CL}	I _{PP} = 1A, t _p = 8/20μs			6.5	V
		I _{PP} = 5A, t _p = 8/20μs			8.5	V
		I _{PP} = 8A, t _p = 8/20μs			10	V
Dynamic resistance ¹⁾	R _{DYN}			0.20		Ω
Junction capacitance	C _J	V _R = 0V, f = 1MHz		17.5	22	pF
		V _R = 5V, f = 1MHz		11.5	16	pF

Notes:

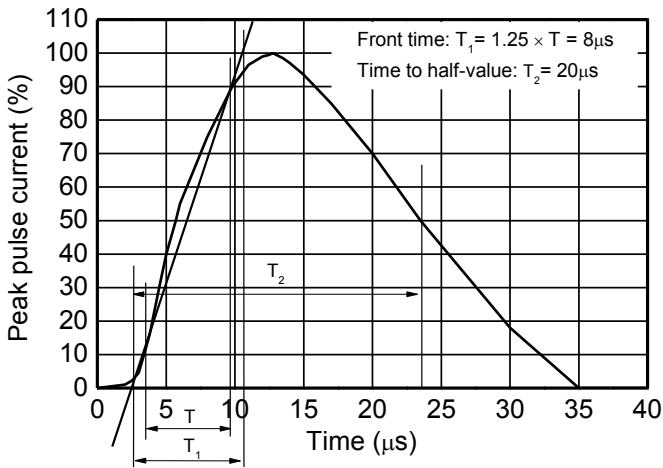
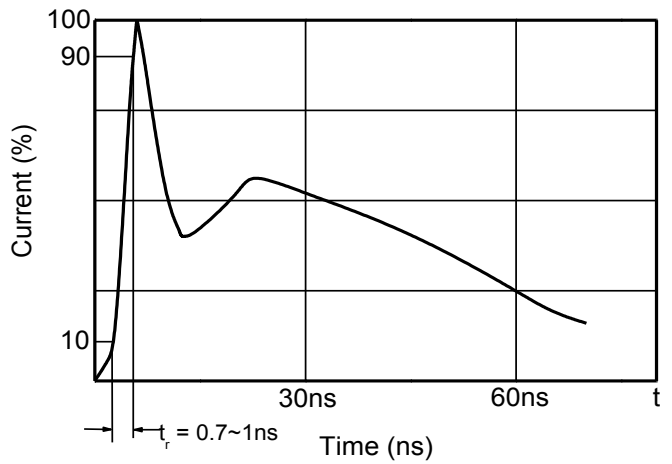
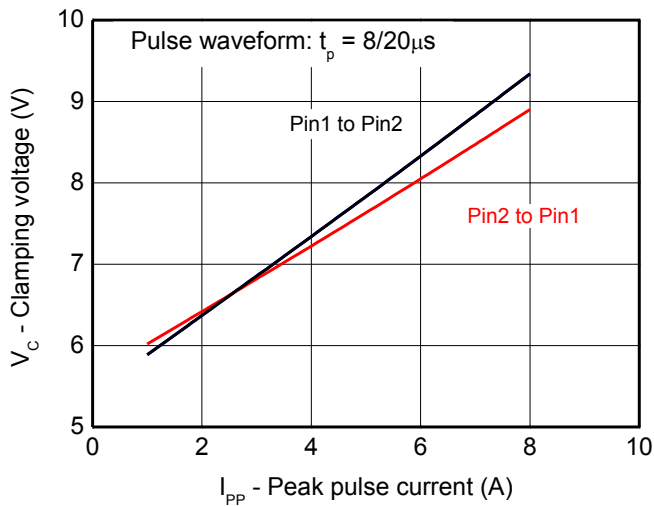
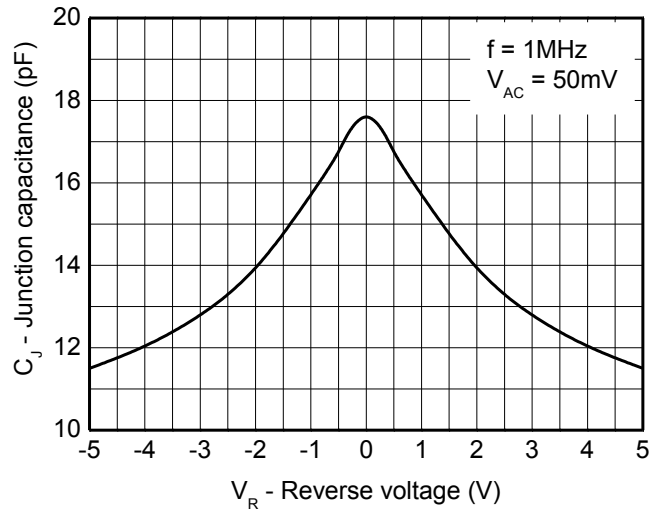
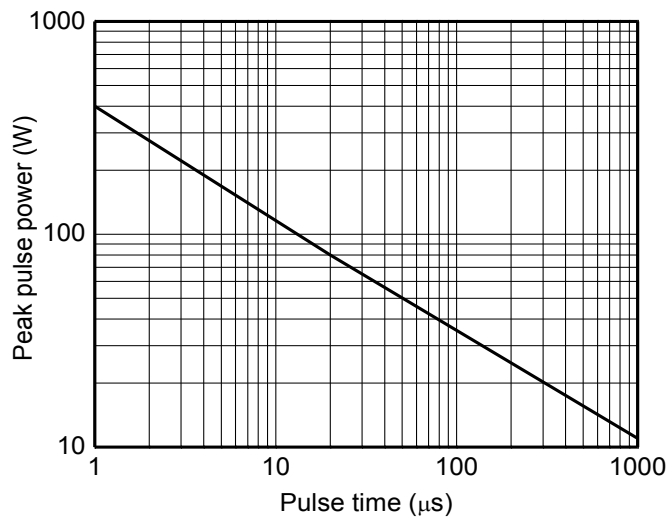
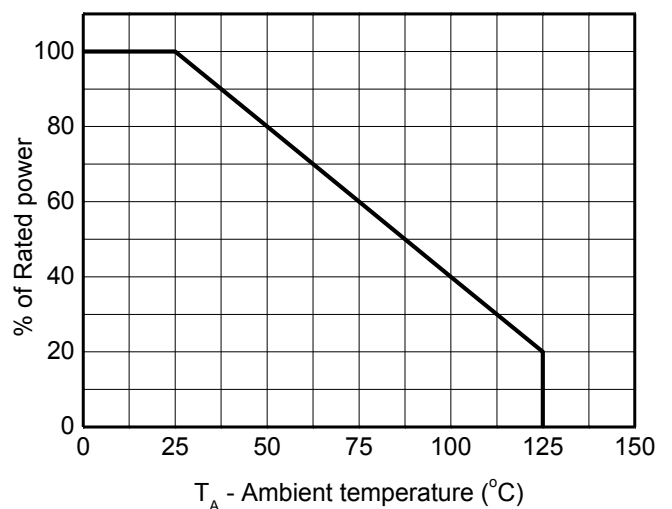
- 1) TLP parameter: Z₀ = 50Ω, t_p = 100ns, t_r = 2ns, averaging window from 60ns to 80ns. R_{DYN} is calculated from 4A to 16A.
- 2) Contact discharge mode, according to IEC61000-4-2.
- 3) Non-repetitive current pulse, according to IEC61000-4-5.

Typical characteristics ($T_A=25^\circ\text{C}$, unless otherwise noted)

8/20 μs waveform per IEC61000-4-5

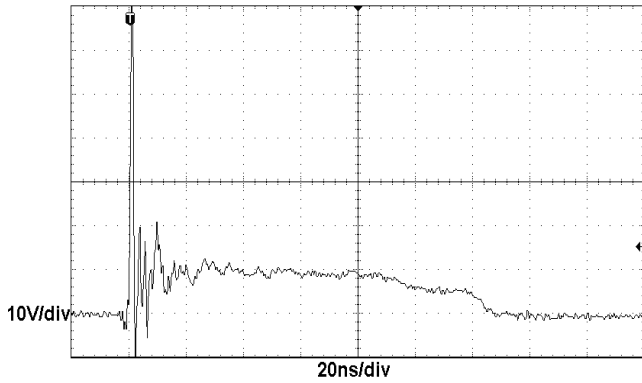
Contact discharge current waveform per IEC61000-4-2

Clamping voltage vs. Peak pulse current

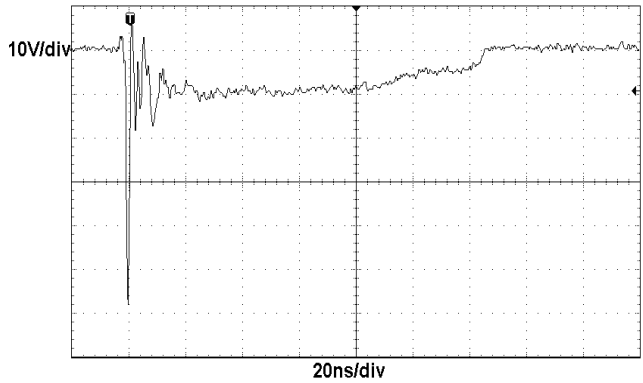
Capacitance vs. Reverses voltage

Non-repetitive peak pulse power vs. Pulse time

Power derating vs. Ambient temperature

Typical characteristics ($T_A=25^\circ\text{C}$, unless otherwise noted)



ESD clamping
(+8kV contact discharge per IEC61000-4-2)



ESD clamping
(-8kV contact discharge per IEC61000-4-2)

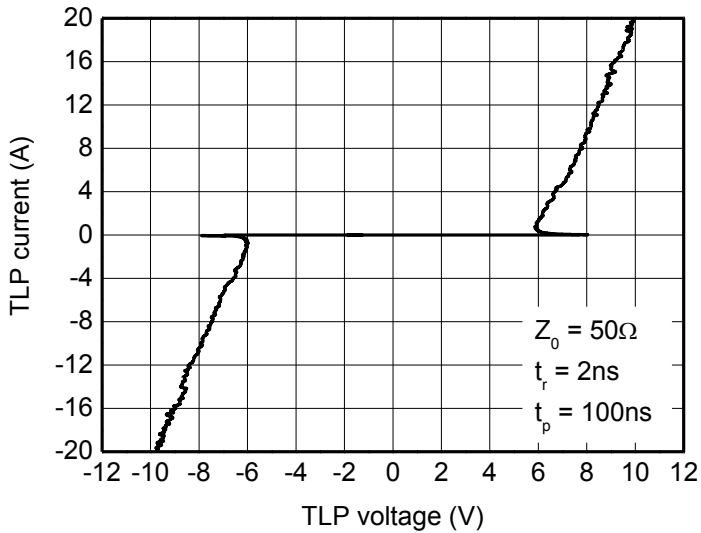

TLP Measurement

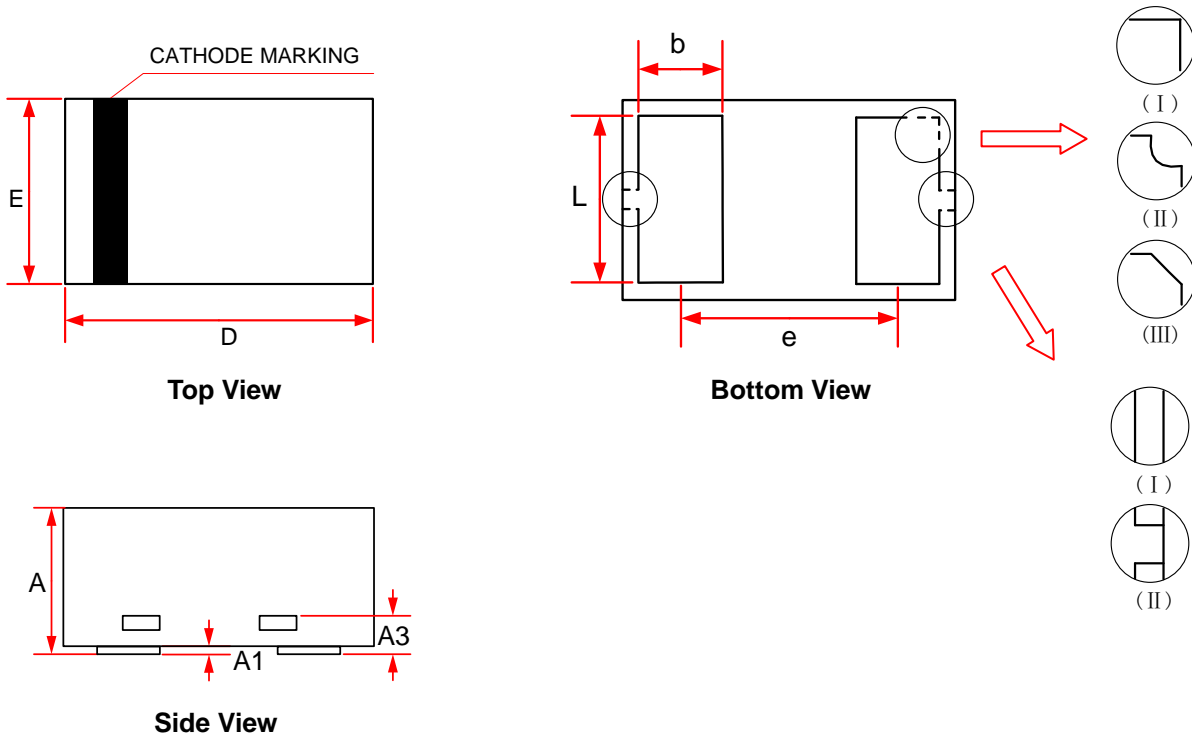
Package outline dimensions
DFN1006-2L

Symbol	Dimensions in Millimeters		
	Min.	Typ.	Max.
A	0.340	0.450	0.530
A1	0.000	0.020	0.050
A3	0.125 Ref.		
D	0.950	1.000	1.075
E	0.550	0.600	0.675
b	0.200	0.250	0.300
L	0.450	0.500	0.550
e	0.650 BSC		

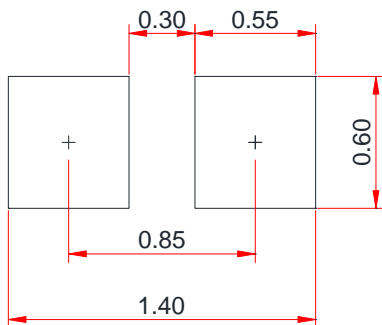
Recommend PCB Layout (Unit: mm)

Notes:

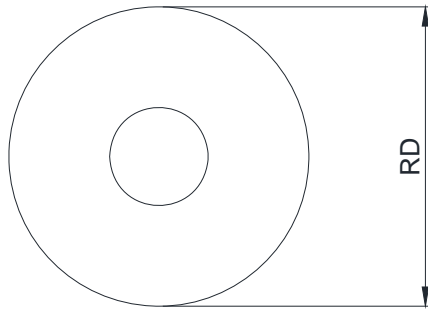
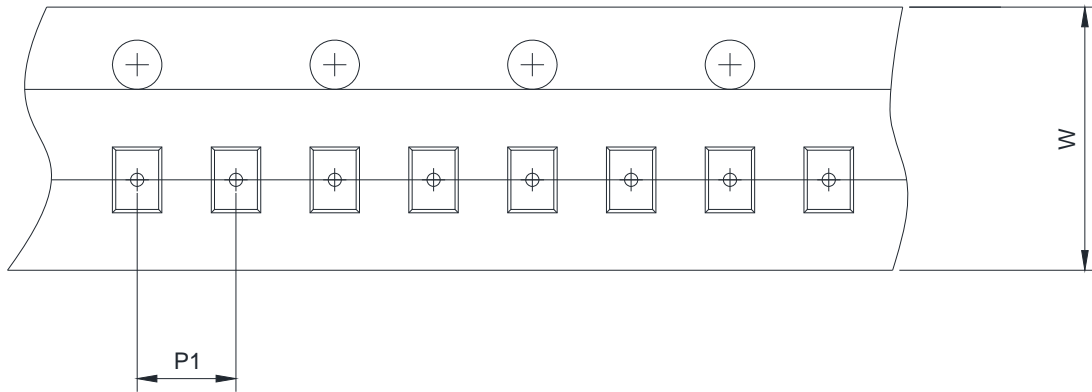
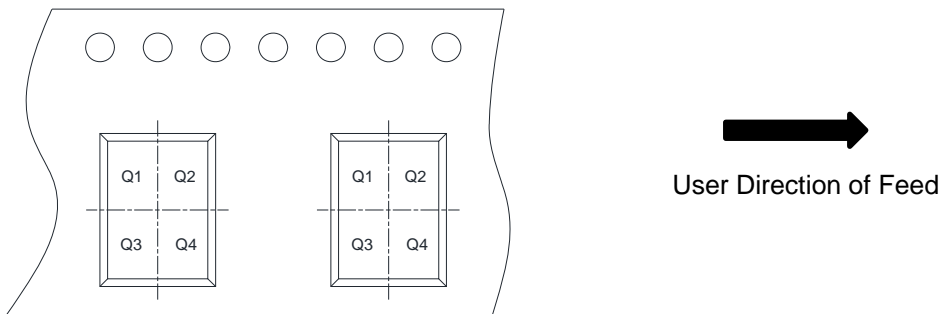
This recommended land pattern is for reference purposes only. Please consult your manufacturing group to ensure your PCB design guidelines are met.

TAPE AND REEL INFORMATION
Reel Dimensions

Tape Dimensions

Quadrant Assignments For PIN1 Orientation In Tape

RD	Reel Dimension	<input checked="" type="checkbox"/> 7inch	<input type="checkbox"/> 13inch		
W	Overall width of the carrier tape	<input checked="" type="checkbox"/> 8mm	<input type="checkbox"/> 12mm		
P	Pitch between successive cavity centers	<input checked="" type="checkbox"/> 2mm	<input type="checkbox"/> 4mm	<input type="checkbox"/> 8mm	
Pin1	Pin1 Quadrant	<input checked="" type="checkbox"/> Q1	<input checked="" type="checkbox"/> Q2	<input type="checkbox"/> Q3	<input type="checkbox"/> Q4

X-ON Electronics

Largest Supplier of Electrical and Electronic Components

Click to view similar products for [ESD Suppressors / TVS Diodes](#) category:

Click to view products by [Will Semiconductor](#) manufacturer:

Other Similar products are found below :

[NTE4902](#) [P4SMAJ15A](#) [P4SMAJ26A](#) [SMAJ400CA-TP](#) [TGL34-47CA](#) [ESDAULC45-1BF4](#) [SM1605E3/TR13](#) [SMF20A-TP](#) [P4SMAJ12A](#)
[CPDUR24V-HF](#) [CPDQC5V0USP-HF](#) [CPDQC5V0-HF](#) [MPLAD30KP45CAE3](#) [MMBZ27VCLQ-7-F](#) [MMAD1108/TR13](#) [MPLAD30KP24A](#)
[ACPDQC5V0R-HF](#) [DFLT170A-7](#) [NTE4900](#) [NTE4926](#) [NTE4938](#) [SMF22A-TP](#) [SMF12A-TP](#) [SLVU2.8-TP](#) [SMLJ6.5CA-TP](#) [SMAJ6.5CA-](#)
[TP](#) [MMAD1108E3/TR13](#) [D5V0M1U2LP3-7](#) [SMAJ400A-TP](#) [AOZ8811DT-03](#) [AOZ8831DI-05](#) [AOZ8831DT-03](#) [SMAJ188CA](#) [3SMC33CA](#)
[BK](#) [CPDQC3V3C-HF](#) [CPDQC12VE-HF](#) [MPLAD30KP170CA](#) [82357120100](#) [5.0SMLJ15CA-TP](#) [5KP18A-TP](#) [P6KE8.2A-TP](#)
[MPLAD30KP43CAE3](#) [SMAJ43A-TP](#) [D5V0F6U8LP33-7](#) [TVS5501V10MUT5G](#) [5.0SMLJ24CA-TP](#) [SMAJ110CA-TP](#) [MPLAD15KP75CAE3](#)
[MMAD1103e3/TR13](#) [DFLT40AQ-7](#)