

For and on behalf of  
**KRB INDUSTRIAL PRECISION CO., LIMITED**  
 香港星坤工業精密有限公司

Revisions  
 (Authorized Signatures)

MARK	DESCRIPTION	DATE	REVISED	APPROVED	UNSPECIFIED TOLERANCES
△ X					$L > 63$ $L > 63$
△ X					$4 < L \leq 16$ $\pm 0.3$
△ X					$L \leq 4$ $\pm 0.2$
					ANGULAR $\pm 5^\circ$

DSND	DATE	SCALE: N/A	MODEL TYPE: X3025HF-XXX-N2
DWN <th>DATE</th> <th>VIEW: </th> <th>PART NO.: 3.00 mm Crimp Style Connectors</th>	DATE	VIEW:	PART NO.: 3.00 mm Crimp Style Connectors
CHKD <th>DATE</th> <th>UNIT: mm</th> <th>DWG NO.:</th>	DATE	UNIT: mm	DWG NO.:
APPD <th>DATE</th> <th>SIZE: A4</th> <th>WEIGHT: 1.0g</th>	DATE	SIZE: A4	WEIGHT: 1.0g
			REVISION: 1/1
			REVISION: A0

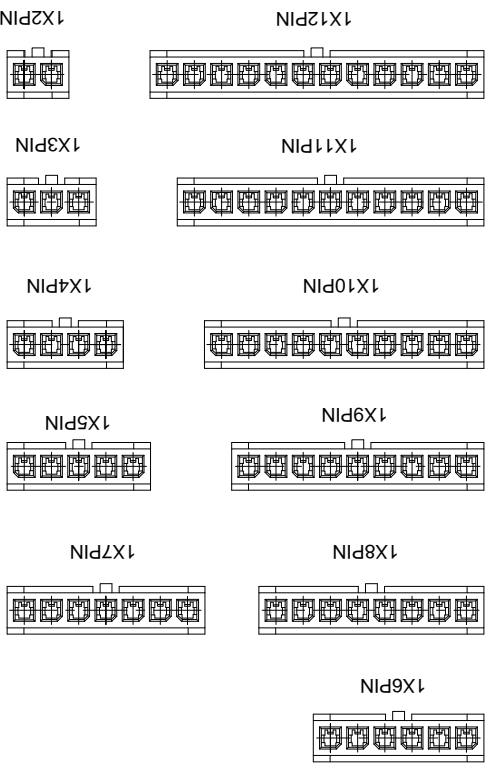
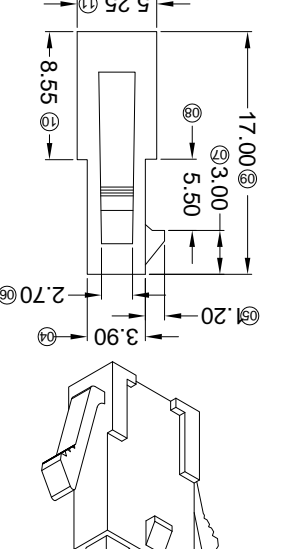
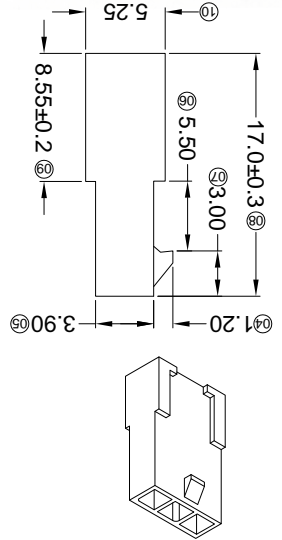
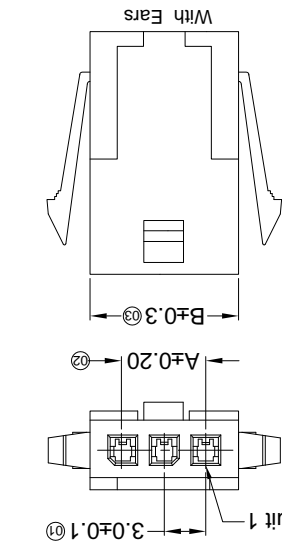
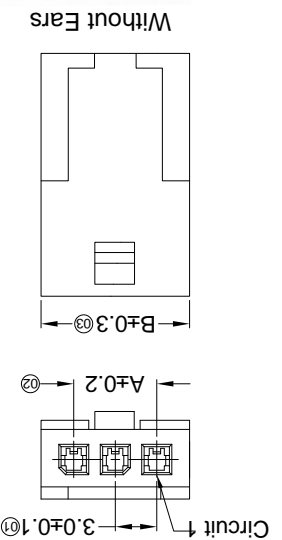

PART NO	Material	Color	Suitable XKB Terminal	Mates With XKB Housing	Note
X3025HF-XX1-N2WH	Nylon 66 94V-2	White	X3025TM	X3025HM	Without Ears
X3025HF-XX1-N2	Nylon 66 94V-2	Natural Color	X3025TM	X3025HM	Without Ears
X3025HF-XXG-N2WH	Nylon 66 94V-2	White	X3025TM	X3025HM	With Ears
X3025HF-XXG-N2	Nylon 66 94V-2	Natural Color	X3025TM	X3025HM	With Ears

Poles	Dimensions(mm)		Dimensions(mm)	
	A	B	A	B
07	18.00	21.90		
06	15.00	18.90	12	33.00
05	12.00	15.90	11	30.00
04	9.00	12.90	10	27.00
03	6.00	9.90	09	27.90
02	3.00	6.90	08	24.90
				21.00
				24.90
				30.90
				33.90
				36.90

- ① Series No. X3025 H F-XX XX-N2 XX  
 ② Category: H-HSG  
 ③ Welding Board Angle: F-Female HSG  
 ④ Row No.-Pin No.: XX-02P~12P  
 ⑤ Plug the Pin & special No.: I-Without Ears G-With Ears  
 ⑥ Material: N2-PA66 94V-2;  
 ⑦ Color: Blank-Natural Color : WH-White

- Specifications:
- Voltage rating: 250V AC / DC
  - Current rating: 5A AC / DC
  - Withstanding voltage: 1000V AC/minute
  - Temperature range: -40°C~+105°C
  - Insulation resistance: ≥1000MΩ
  - Contact resistance: ≤10mΩ
  - After environmental testing: ≤20mΩ

For and on behalf of  
**XKB INDUSTRIAL PRECISION CO., LIMITED**  
 香港星坤工業精密有限公司

MARK	DESCRIPTION	DATE	REVISED	APPROVED	UNSPECIFIED TOLERANCES
△ X					L > 63
△ X					16 < L ≤ 63
△ X					4 < L ≤ 16
△ X					L ≤ 4
					ANGULAR

REVISIONS	DATE	REVISED	APPROVED	UNSPECIFIED TOLERANCES
				L > 63
				16 < L ≤ 63
				4 < L ≤ 16
				L ≤ 4
				ANGULAR

DATE	SCALE: N/A	MODEL TYPE:
		X3025HM-XX-N2

DATE	VIEW:	PART NO.:
		X3025HM-XX-N2

DATE	UNIT: mm	DWG NO.:
		3.00 mm Crimp Style Connectors

DATE	SIZE: A4	WEIGHT	SHEET	REVISION
		1.0g	1/1	A0

PART NO	Material	Suitable XKB Terminal	Mates With XKB Wafer
X3025HM-XX-N2	Nylon 66 94V-2	X3025TF	X3025W

Poles	Dimensions (mm)		Poles	A	B
	A	B			
07	18.00	21.85	12	33.00	36.85
06	15.00	18.85	11	30.00	33.85
05	12.00	15.85	10	27.00	30.85
04	9.00	12.85	09	24.00	27.85
03	6.00	9.85	08	21.00	24.85

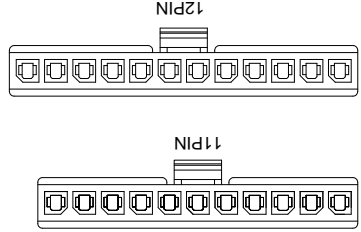
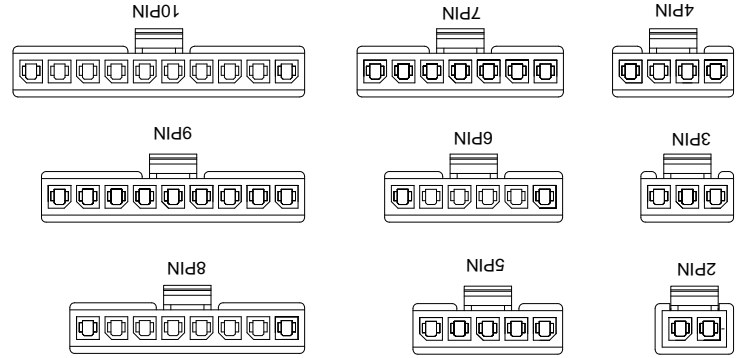

- Specifications:**  
 • Voltage rating: 250V AC / DC  
 • Current rating: 5A AC / DC  
 • Withstanding voltage: 1000V AC/minute  
 • Temperature range: -40°C~+105°C  
 • Insulation resistance: ≥1000MΩ  
 • Contact resistance: ≤10mΩ  
 • After environmental testing: ≤20mΩ
- ① Series No.  
 ② Category: H-HSG  
 ③ Welding Board Angle: M-Male HGS  
 ④ Row No./Pin No.: XX-02P~12P  
 ⑤ Plug the Pin & special No.  
 ⑥ Material: N2-PA66 94V-2  
 ⑦ Color: Blank-Natural Color

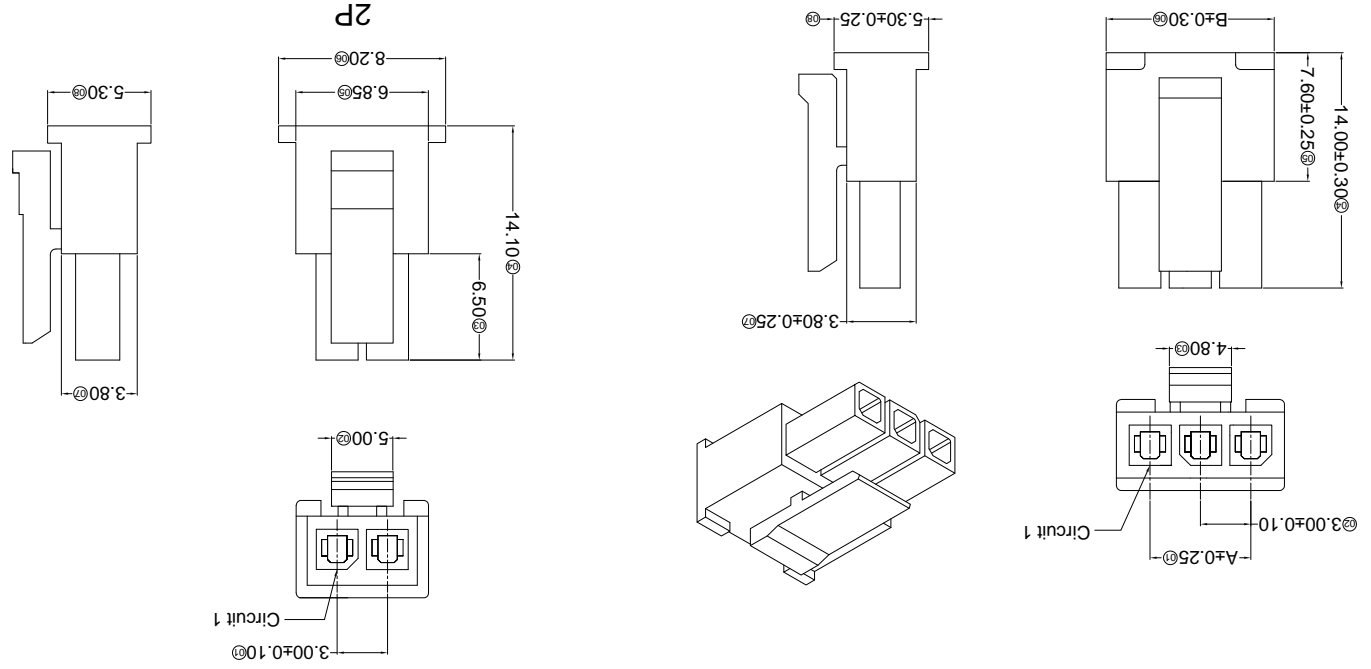

X3025 H M-XX X-N2 XX

8 7 6 5 4 3 2 1 A B C D E F

For and on behalf of  
**XKB INDUSTRIAL PRECISION CO., LIMITED**  
 香港星坤工業精密有限公司

REVISIONS  
 (Unauthorized Signatures)

MARK	DESCRIPTION	DATE	REVISED	APPROVED	UNSPECIFIED TOLERANCES
△ X					L > 63 ± 0.5
△ X					16 > L ≤ 63 ± 0.4
△ X					4 < L ≤ 16 ± 0.3
△ X					L ≤ 4 ± 0.2
					ANGULAR ± 5°

DATE	DATE	DATE	DATE	DATE	DATE	DATE	DATE	DATE
DNSD	DWN	CHKD	APPD					
SCALE: N/A	VIEW:	UNIT: mm	SIZE: A4					
MODEL TYPE: X3025TF-PXXX	PART NO.:	3.00 mm Crimp Style Connectors		DWG NO.:				
WEIGHT: 1.0g	SHEET: 1/1	REVISION: A0						

PART NO	Material	Wire Range	Insulation O.D.	Finish	Used in XKB Housing
X3025TF-PG30	Phosphor Bronze	AWG#20-24	1.85mm(Max)	Stamping Before Plating:30~50u" Ni;Contact Area Gold:30u" Min.	X3025HM
X3025TF-PG15				Stamping Before Plating:30~50u" Ni;Contact Area Gold:15u" Min.	
X3025TF-PG01				Stamping Before Plating:30~50u" Ni;Contact Area Gold Flash	
X3025TF-PSN				Stamping Before Plating:30~50u" Ni;70~120u" Sn	

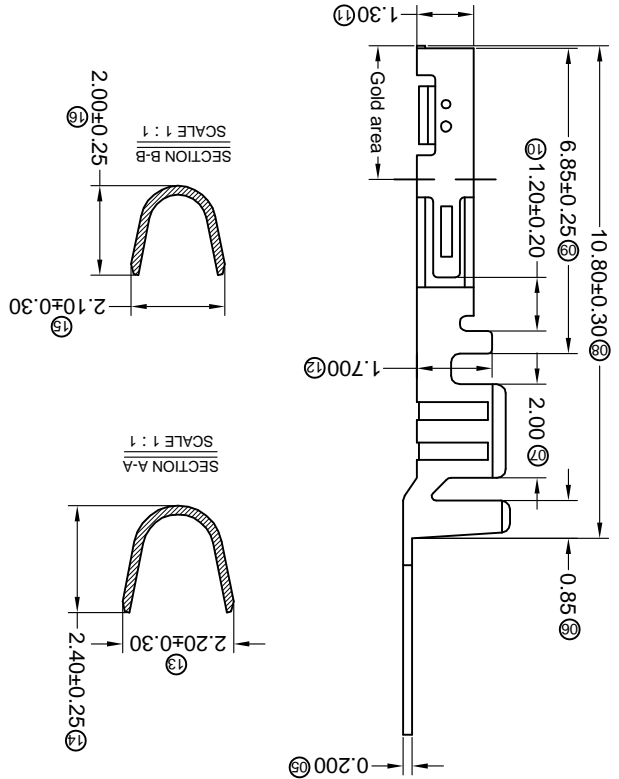
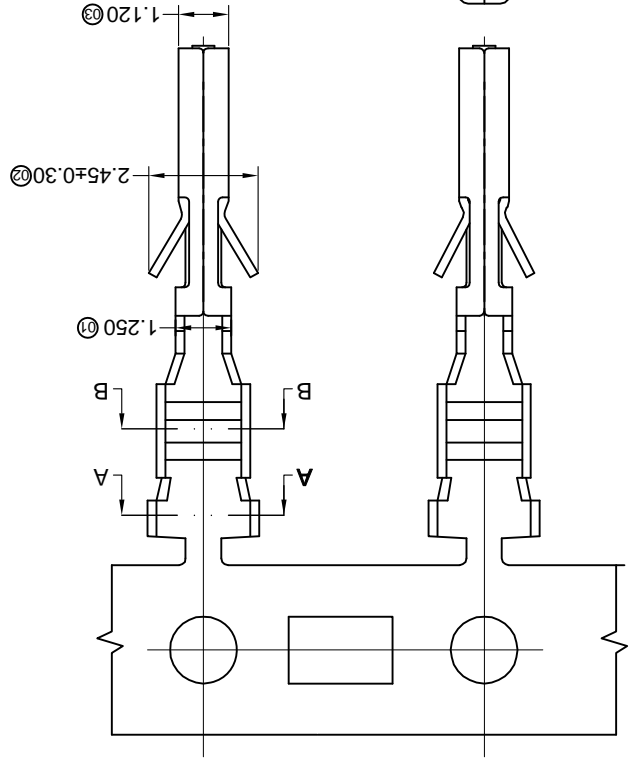
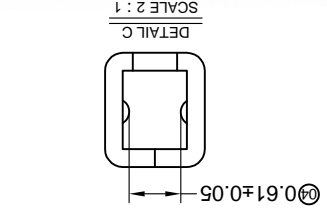

■ Specifications :

- Voltage rating: 250V AC / DC
- Current rating: 5A AC / DC
- Withstanding voltage: 1000V AC/minute
- Temperature range: -40°C~+85°C
- Insulation resistance: ≥1000MΩ
- Contact resistance: ≤10mΩ
- After environmental testing: ≤20mΩ

X3025 T-F-P XX X-X  
 ① Series Number  
 ② Category: T-terminal  
 ③ Shape: F-Female Terminal  
 ④ Material: P-Phosphor bronze  
 ⑤ Plating style:  
 ⑥ G-Gold-Plated Contact  
 \*01-Gold Flash \*15-15u" \*30-30u"  
 SN-Bright tin plating 70-120u"  
 ⑦ Plating method:  
 Blank-Stamping before plating  
 ⑧ Mold No./Mark/Special No.

REVISIONS  
*Authorized Signature(s)*

For and on behalf of  
**KXB INDUSTRIAL PRECISION CO., LIMITED**  
香港星坤工業精密有限公司

MARK	DESCRIPTION	DATE	REVISED	APPROVED	UNSPECIFIED TOLERANCES
△ X					L > 63
△ X					16 > L ≤ 63
△ X					4 < L ≤ 16
△ X					L ≤ 4
					ANGULAR ±5°

REVISION	SHEET	WEIGHT	DATE	DATE	DATE	DATE
A0	1/1	1.0g				

**KXB INDUSTRIAL PRECISION CO., LIMITED**

DSND	DWN	CHKD	APPD
DATE	DATE	DATE	DATE
SCALE: N/A	VIEW:	UNIT: mm	SIZE: A4
MODEL TYPE: X3025TM-PXX	PART NO.:	3.00 mm Crimp Style Connectors	
	DWG NO.:		

PART NO	Material	Wire Range	Insulation O.D.	Finish
X3025TM-PSN	Phosphor Bronze	AWG#20-24	1.85mm(Max)	Stamping Before Plating:30u" Ni;70u" Sn
X3025TM-PG01				Stamping Before Plating:30u" Ni;Contact Area Gold Flash
X3025TM-PG15				Stamping Before Plating:30u" Ni;Contact Area Gold:15u" Min.
X3025TM-PG30				Stamping Before Plating:30u" Ni;Contact Area Gold:30u" Min.

Used in XKB Housing

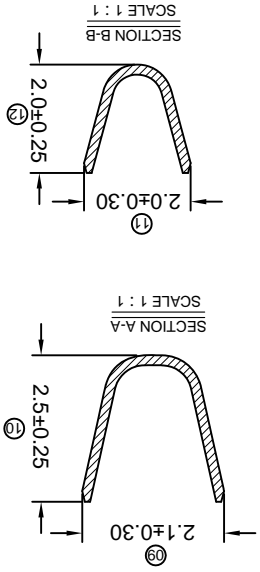
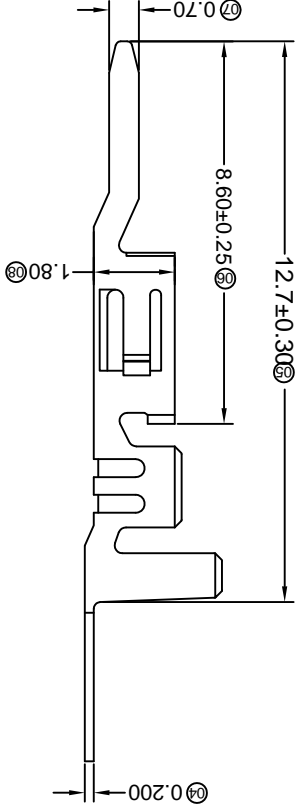
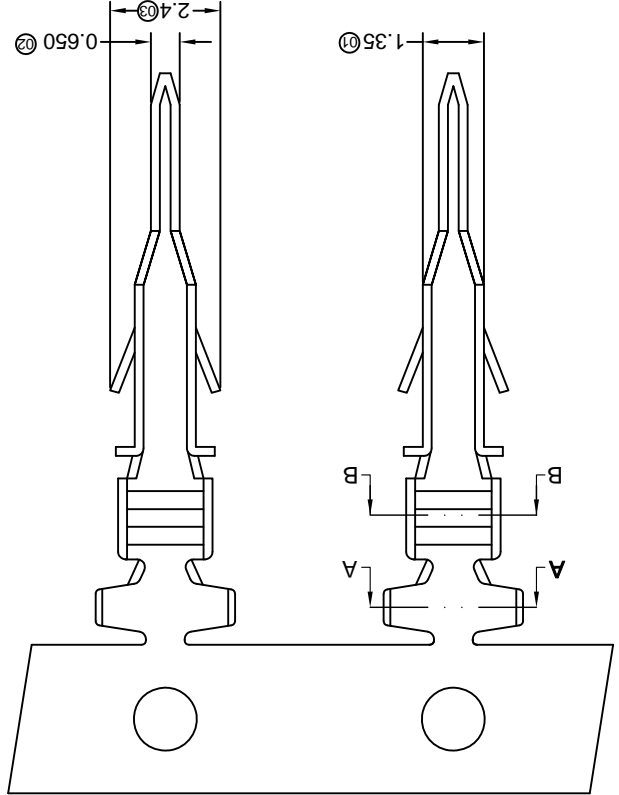

- Specifications :**
- Voltage rating: 250V AC / DC
  - Current rating: 5A AC / DC
  - Withstanding voltage: 1000V AC/minute
  - Temperature range: -25°C~+85°C
  - Insulation resistance: ≥1000MΩ
  - Contact resistance: ≤10mΩ
  - After environmental testing: ≤20mΩ
- X3025 T M-P XX X-X**
- ① Series Number
  - ② Category: T-terminal
  - ③ Shape: M-Male Terminal
  - ④ Material: P-Phosphor bronze
  - ⑤ Plating style: G-Gold-Plated Contact
  - ⑥ \*01-Gold Flash \*15-15u" \*30-30u"
  - ⑦ SN-Bright tin plating 70u"
  - ⑧ Plating method: Blank-Stamping before plating
  - ⑨ Mold No./Mark/Special No.

REVISED SIGNATURES			UNSPECIFIED TOLERANCES		REVISIONS		APPROVED		DATE		DESCRIPTION		MARK	
FOR and on behalf of <b>XKB INDUSTRIAL PRECISION CO., LIMITED</b> 香港星坤工業精密有限公司			L > 63 ±0.5		APPROVED		REVIS		DATE		DESCRIPTION		MARK	
			16 < L ≤ 63 ±0.4										△ X	
			4 < L ≤ 16 ±0.3										△ X	
			L ≤ 4 ±0.2										△ X	
			ANGULAR ±5°											

DSND		DATE	SCALE: N/A	MODEL TYPE: X3025WR-2*XXB-XXSN
DWN		DATE	VIEW:	PART NO.:
CHKD		DATE	UNIT: mm	3.00 mm Crimp Style Connectors
APPD		DATE	SIZE: A4	DWG NO.:
WEIGHT: 1.0g				
SHEET: 1/1				
REVISION: A0				

Part No.	Material	Material (Pin)	Finish (Pin)	Mates With XKB Housing	
				X3025WR-2*XXB-L-PSN	X3025H
X3025WR-2*XXB-L-PSN	LCP UL 94V-0	Brass	Tin-Plated	Mates With XKB Housing	
X3025WR-2*XXB-46SN	Nylon 46 UL 94V-0				
X3025WR-2*XXB-N0SN	Nylon 66 UL 94V-0				

Poles	Dimensions (mm)		Poles	Dimensions (mm)	
	A	B		A	B
2*01	---	6.65	2*07	18.00	24.65
2*02	3.00	9.65	2*08	21.00	27.65
2*03	6.00	12.65	2*09	24.00	30.65
2*04	9.00	15.65	2*10	27.00	33.65
2*05	12.00	18.65	2*11	30.00	36.65
2*06	15.00	21.65	2*12	33.00	39.65

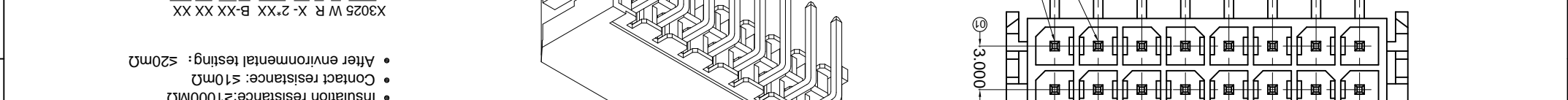
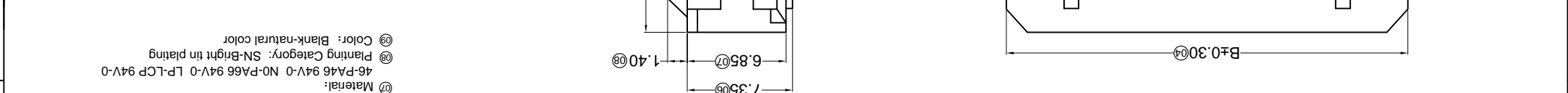
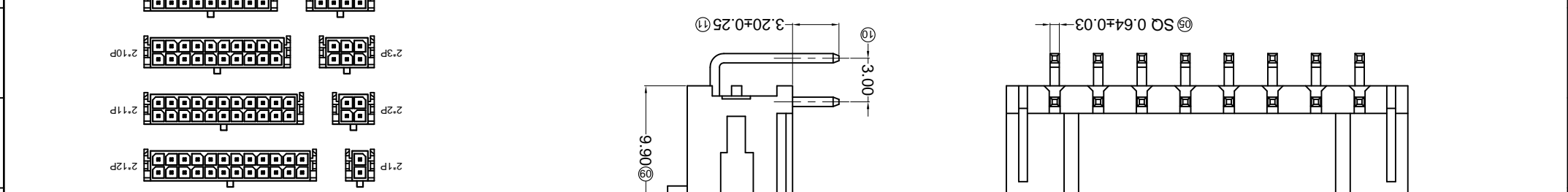

**Specifications :**

- Voltage rating: 250V AC / DC
- Current rating: 5A AC / DC
- Withstanding voltage: 1000V AC/minute
- Temperature range: -25°C~+85°C
- Insulation resistance: ≥1000MΩ
- Contact resistance: ≤10mΩ
- After environmental testing: ≤20mΩ

① Series No.  
② Category: W-water  
③ Welding Board Angle: R-90°  
④ Welding Way: Blank-DIP  
⑤ Row No.-Pin No.: 2\*XX-2\*01P-2\*12P  
⑥ Special NO.: B-Without positioning column  
⑦ Material: 46-PA46 94V-0 N0-PA66 94V-0 LP-LCP 94V-0  
⑧ Plating Category: SN-Bright tin plating  
⑨ Color: Blank-natural color

For and on behalf of  
**KKB INDUSTRIAL PRECISION CO., LIMITED**  
 香港星坤工業精密有限公司

MARK	DESCRIPTION	DATE	REVISED	APPROVED	UNSPECIFIED TOLERANCES
△ X					L > 63
△ X					16 < L ≤ 63
△ X					4 < L ≤ 16
△ X					L ≤ 4
					ANGULAR
					± 5°

REVISIONS	DATE	DESCRIPTION
1		

REVISIONS	DATE	DESCRIPTION
1		

REVISIONS	DATE	DESCRIPTION
1		

PART NO	Material	Material(Pin)	Finish(Pin)	Mates With XKB Housing
3025WRS-XXC-N0SN	PA66 UL 94V-0	Brass	Tin-Plated	X3025H
3025WRS-XXC-LP5N	LCP UL 94V-0		Tin Plating Fog	
3025WRS-XXC-LPSW	LCP UL 94V-0			

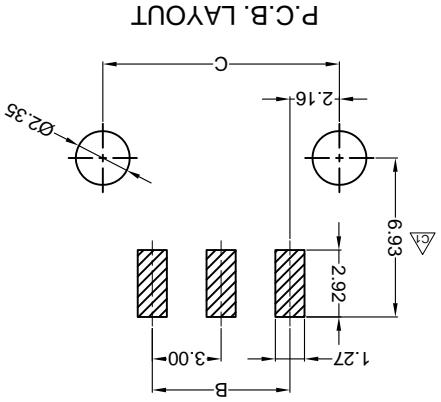
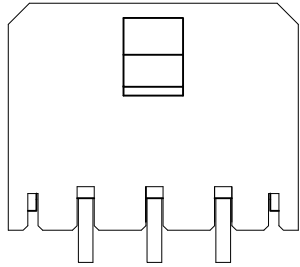
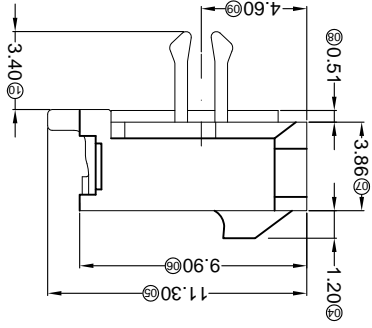
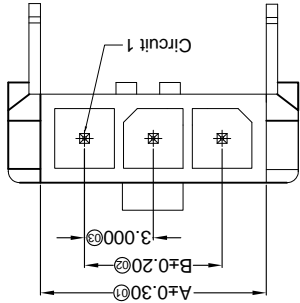

- ①** Series No.  
**②** Category: W-water  
**③** Welding Board Angle: R-90°  
**④** Welding Way: S-SMT  
**⑤** Row No.-Pin No.: XX-Single row  
**⑥** Special NO.: C-The harpoon  
**⑦** Material: LP-LCP 94V-0 NO-LCP 94V-0  
**⑧** Plating Category:  
 SN-Bright tin plating 70U  
 SW-Fog Tin plating  
**⑨** Color: Blank-natural color

X3025 W R S-XX C-XX XX XX

- Specifications :**  
 • Voltage rating: 250V AC / DC  
 • Current rating: 5A AC / DC  
 • Withstanding voltage: 1000V AC/minute  
 • Temperature range: -25°C~+85°C  
 • Insulation resistance: ≥1000MΩ  
 • Contact resistance: ≤10mΩ  
 • After environmental testing: ≤20mΩ

Poles	Dimensions (mm)		
	A	B	C
02	6.85	3.00	7.30
03	9.85	6.00	10.30
04	12.85	9.00	13.30
05	15.85	12.00	16.30
06	18.85	15.00	19.30
07	21.85	18.00	22.30
08	24.85	21.00	25.30
09	27.85	24.00	28.30
10	30.85	27.00	31.30
11	33.85	30.00	34.30
12	36.85	33.00	37.30

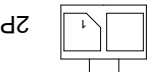
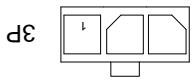
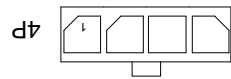
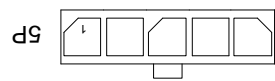
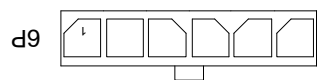
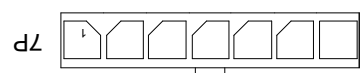
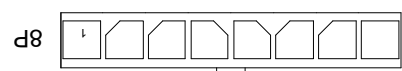
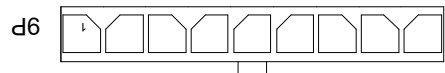
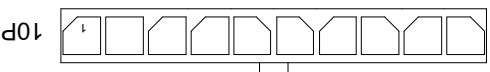
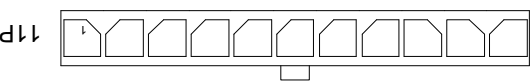
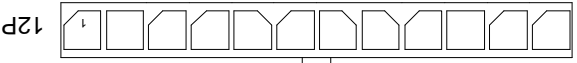

MODEL TYPE:	SCALE:	DATE:
X3025WRS-XXC-XXXX	N/A	

PART NO.:	VIEW:	DATE:
3.00 mm Crimp Style Connectors		

CHKD	DATE:	UNIT:
		mm

APPD	DATE:	SIZE:
		A4

WEIGHT	SHEET	REVISION
1.0g	1/1	A0



REVISIONS  
Authorized Signatures(s)

MARK	DESCRIPTION	DATE	REVISED	APPROVED	UNSPECIFIED TOLERANCES
△ X					L > 63 ± 0.5
△ X					16 > L ≤ 63 ± 0.4
△ X					4 < L ≤ 16 ± 0.3
△ X					L ≤ 4 ± 0.2
					ANGULAR ± 5°

For and on behalf of  
KKB INDUSTRIAL PRECISION CO., LIMITED  
香港星坤工業精密有限公司

KKB INDUSTRIAL PRECISION CO., LIMITED

MARK	DESCRIPTION	DATE	REVISED	APPROVED
△ X				
△ X				
△ X				

DSND	DATE	SCALE: N/A	MODEL TYPE: X3025WRS-XXD-LPXXX
DWN	DATE	VIEW:	PART NO.: X3025WRS-XXD-LPXXX
CHKD	DATE	UNIT: mm	DWG NO.: 3.00 mm Crimp Style Connectors
APPD	DATE	SIZE: A4	

P.C.B. LAYOUT

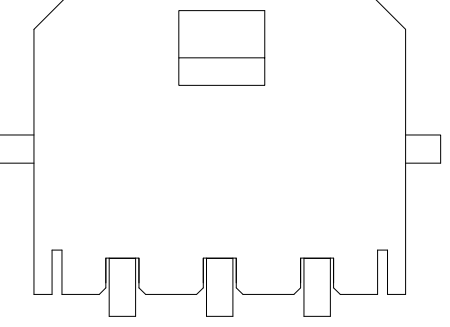
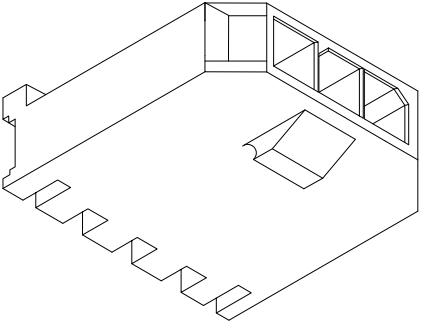
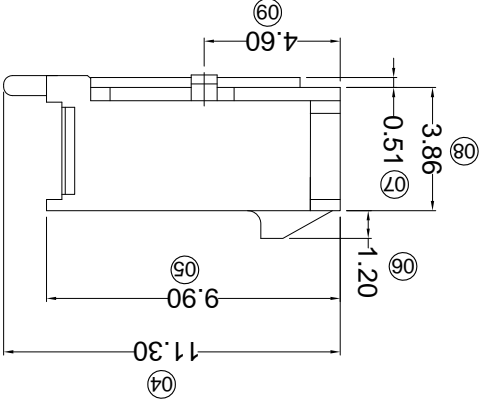
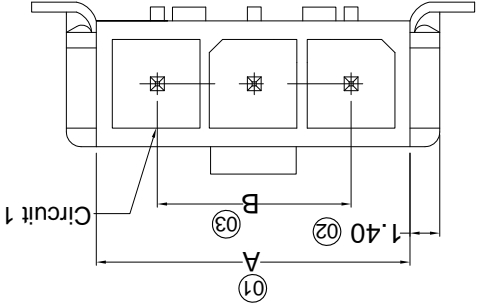
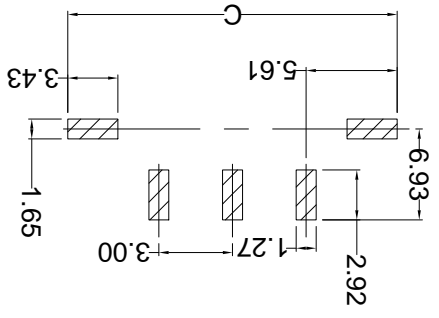

- X3025 W R S- XX D-LP SW XX
- ① Series No.
  - ② Category: W-water
  - ③ Welding Board Angle: R-90°
  - ④ Welding Way: S-SMT
  - ⑤ Row No.-Pin No.
  - ⑥ XX-Single row
  - ⑦ Special NO.
  - ⑧ D-Solder Tabs
  - ⑨ Material: LP-LCP 94V-0
  - ⑩ Plating Category: V\*\*All Gold-Plated
  - G\*\*Gold-Plated Contact
  - \*01-Gold Flash ; \*02-2U" ; \*03-3U" ; \*05-5U"
  - \*10-10U" ; \*15-15U" ; \*30-30U" ; \*50-50U"
  - \*21-21U" ; \*29-29U" ; \*18.00 ; \*18.85 ; \*15.00 ; \*15.85 ; \*12.00 ; \*12.85 ; \*9.00 ; \*9.85 ; \*6.00 ; \*6.85 ; \*3.00 ; \*14.20 ; \*17.20 ; \*20.20 ; \*23.20 ; \*26.20 ; \*29.20 ; \*32.20 ; \*35.20 ; \*38.20 ; \*41.20 ; \*44.20
  - ⑪ SN-Bright tin plating 70U"
  - ⑫ SN1-Bright tin plating 120U"Min. ;
  - ⑬ SW-Fog Tin plating
  - ⑭ Color: Blank-natural color

Poles	A	B	C
12	36.85	33.00	44.20
11	33.85	30.00	41.20
10	30.85	27.00	38.20
9	27.85	24.00	35.20
8	24.85	21.00	32.20
7	21.85	18.00	29.20
6	18.85	15.00	26.20
5	15.85	12.00	23.20
4	12.85	9.00	20.20
3	9.85	6.00	17.20
2	6.85	3.00	14.20
	A	B	C

Dimensions

- Specifications :
- Voltage rating: 250V AC / DC
  - Current rating: 5A AC / DC
  - Withstanding voltage: 1000V AC/minute
  - Temperature range: -25°C~+85°C
  - Insulation resistance: ≥1000MΩ
  - Contact resistance: ≤10mΩ
  - After environmental testing: ≤20mΩ
  - Mark "\*"Indicate Dimensions Need To Controlled In Emphasis





REVISIONS  
*Authorized Signatures*

MARK	DESCRIPTION	DATE	REVISED	APPROVED	UNSPECIFIED TOLERANCES
△ X					L > 63
△ X					16 < L ≤ 63
△ X					4 < L ≤ 16
△ X					L ≤ 4
					ANGULAR

For and on behalf of  
**KKB INDUSTRIAL PRECISION CO., LIMITED**  
香港星坤工業精密有限公司

**KKB INDUSTRIAL PRECISION CO., LIMITED**

WEIGHT	1.0g
SHEET	1/1
REVISION	A0
SIZE:	A4
UNIT:	mm
VIEW:	
SCALE:	N/A
MODEL TYPE:	X3025WR-XX-XXSNXX
PART NO.:	
DWG NO.:	3.00mm Crimp Style Connectors

Recommended P.C.B Layout  
General Tolerance ±0.05

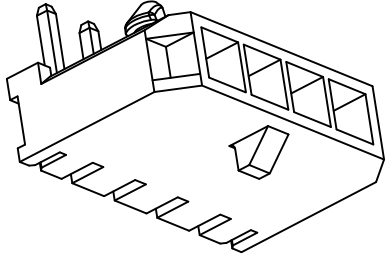
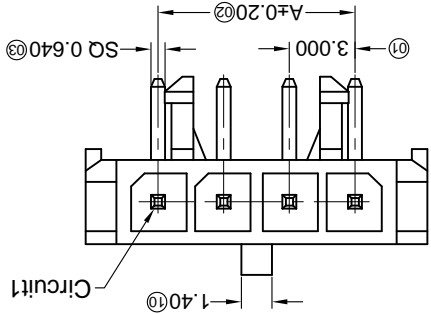
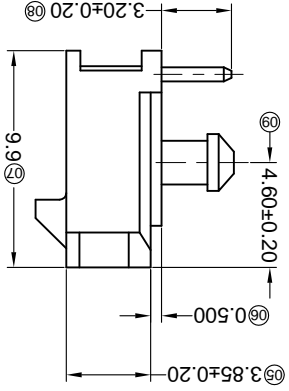
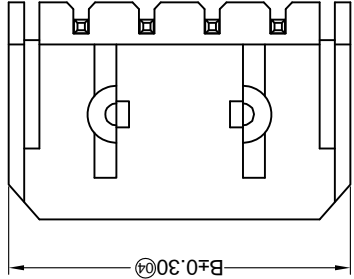
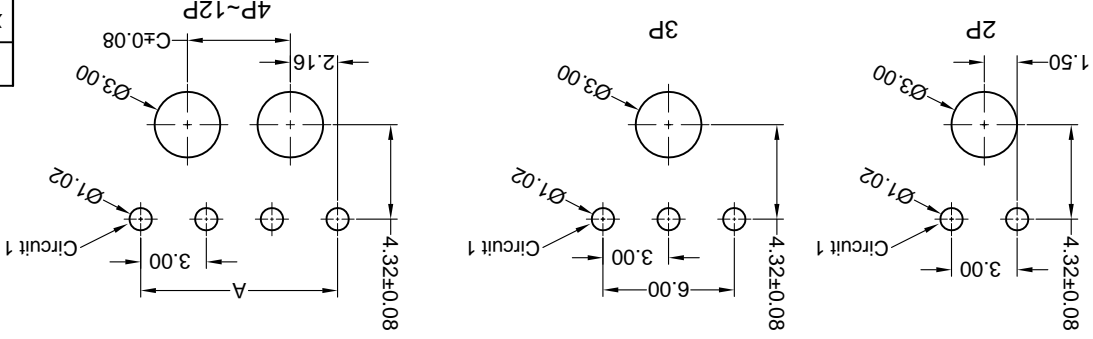

PART NO	Material	Material(Pin)	Finish(Pin)	Mates With KKB Housing
X3025WR-XX-LPNSXX	LCP UL 94V-0	Brass	Tin-Plated	X3025H
X3025WR-XX-N0NSXX	PA66 UL 94V-0			

Poles	Dimensions(mm)				Poles	Dimensions(mm)			
	A	B	C			A	B	C	
01	6.65	---	---	18.00	07	18.00	24.65	13.70	C
02	3.00	9.65	---	21.00	08	21.00	27.65	16.70	
03	6.00	12.65	---	24.00	09	24.00	30.65	19.70	
04	9.00	15.65	4.70	27.00	10	27.00	33.65	22.70	
05	12.00	18.65	7.70	30.00	11	30.00	36.65	25.70	
06	15.00	21.65	10.70	33.00	12	33.00	39.65	28.70	

- ① Series No.
- ② Category: W-water
- ③ Welding Board Angle: R-90°
- ④ Welding Way: Blank-DIP
- ⑤ Row No.-Pin No.: XX-Single row
- ⑥ Plug the Pin & Special No.:
- ⑦ Material:
- ⑧ LP-LCP 94V-0 N0-PA66 94V-0
- ⑨ Plating Category:
- ⑩ SN-Bright tin plating 70u" Min.
- ⑪ Color: Blank-Natural Color Black

X3025 W R X - XX X - XX SN XX  
① ② ③ ④ ⑤ ⑥ ⑦ ⑧ ⑨

- Specifications :
- Voltage rating: 250V AC / DC
  - Current rating: 5A AC / DC
  - Withstanding voltage: 1500V AC/minute
  - Temperature range: -40°C~+105°C
  - Insulation resistance: ≥1000MΩ
  - Contact resistance: ≤10mΩ
  - After environmental testing: ≤20mΩ

REVISIONS  
*Unauthorized Signatures(s)*

For and on behalf of  
**KXB INDUSTRIAL PRECISION CO., LIMITED**  
香港星坤工業精密有限公司

MARK	DESCRIPTION	DATE	REVISED	APPROVED	UNSPECIFIED TOLERANCES
△ X					L > 63
△ X					16 < L ≤ 63
△ X					4 < L ≤ 16
△ X					L ≤ 4
					ANGULAR
					± 5°

REVISION	SHEET	WEIGHT	SIZE	DATE	DATE	DATE	DATE
A0	1/1	1.0g	A4				

APPD	CHKD	DWN	DSND

UNIT	VIEW	SCALE
mm	⑩	N/A

PART NO.	MODEL TYPE
3.00mm Crimp Style Connectors	X3025WR-XXB-XXSN

PART NO	Material	Material(Pin)	Finish(Pin)	Mates With XKB Housing
X3025WR-XXB-LPSN	LCP UL 94V-0	Brass	Tin-Plated	X3025H
X3025WR-XXB-N0SN	PA66 UL 94V-0			

Series No.	①	②	③	④	⑤	⑥	⑦	⑧	⑨
X3025 W R X - XX B - XX SN XX	01	02	03	04	05	06	07	08	09
	24.65	27.65	30.65	33.65	36.65	39.65	33.00	30.00	27.00

- ① Series No.
- ② Category: W-water
- ③ Welding Board Angle: R-90°
- ④ Welding Way: Blank-DIP
- ⑤ Row No.-Pin No.: XX-01P-12P
- ⑥ Plug the Pin & Special No.:
- ⑦ B-Without positioning column
- ⑧ Material: LP-LCP 94V-0;
- ⑨ N0-PA66 94V-0
- ⑩ Planting Category: SN-Bright tin plating
- ⑪ Color: Blank-Natural Color Black

- Specifications :**
- Voltage rating: 250V AC / DC
  - Current rating: 5A AC / DC
  - Withstanding voltage: 1500V AC/minute
  - Temperature range: -40°C~+105°C
  - Insulation resistance: ≥1000MΩ
  - Contact resistance: ≤10mΩ
  - After environmental testing : ≤20mΩ

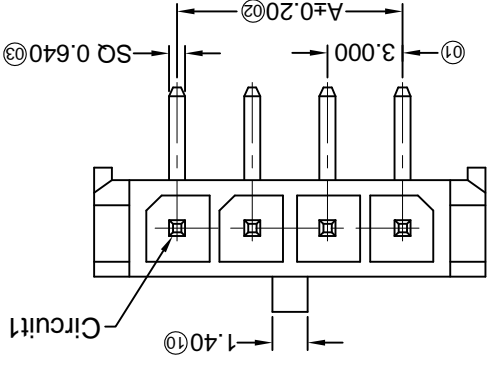
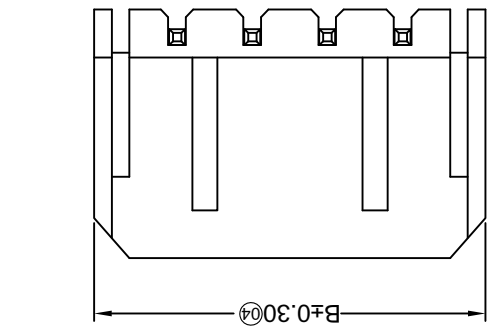
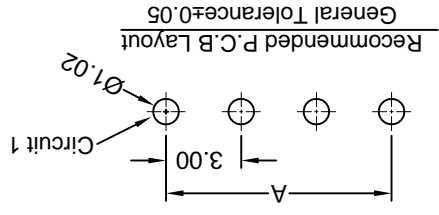
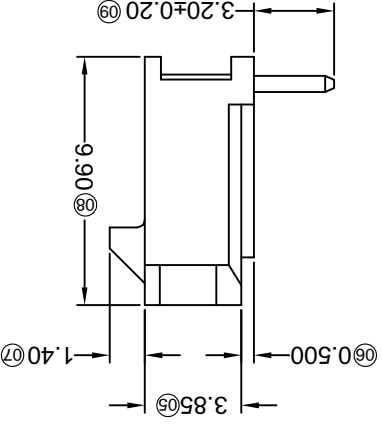
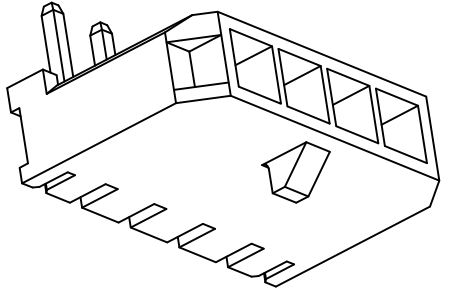

For and on behalf of  
**KXB INDUSTRIAL PRECISION CO., LIMITED**  
 香港星坤工業精密有限公司

REVISIONS  
 Authorized Signature(s)

MARK	DESCRIPTION	DATE	REVISED	APPROVED	UNSPECIFIED TOLERANCES
△ X					L > 63 ± 0.5
△ X					16 < L ≤ 63 ± 0.4
△ X					4 < L ≤ 16 ± 0.3
△ X					L ≤ 4 ± 0.2
					ANGULAR ± 5°

REVISION	SHEET	WEIGHT	SIZE	DATE	DATE	DATE	DATE
A0	1/1	1.0g	A4				

**KXB INDUSTRIAL PRECISION CO., LIMITED**

APPD	CHKD	DWN	DSND

UNIT	VIEW	SCALE
mm	VIEW: ①	N/A

MODEL TYPE: X3025WR-XXC-XXSN  
 PART NO.:  
 3.00mm Crimp Style Connectors  
 DWG NO.:

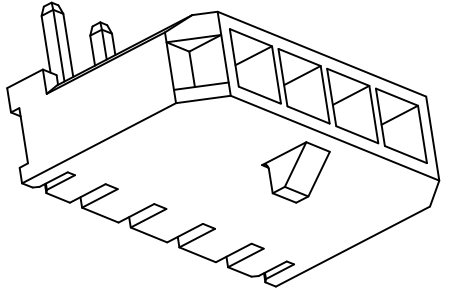
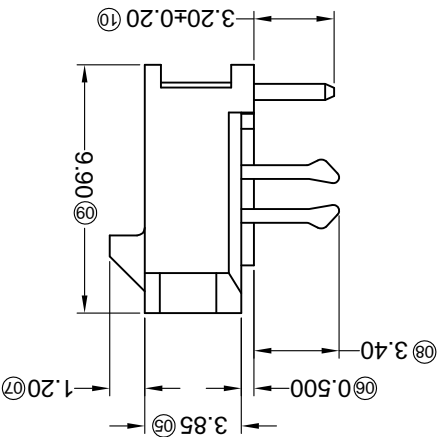
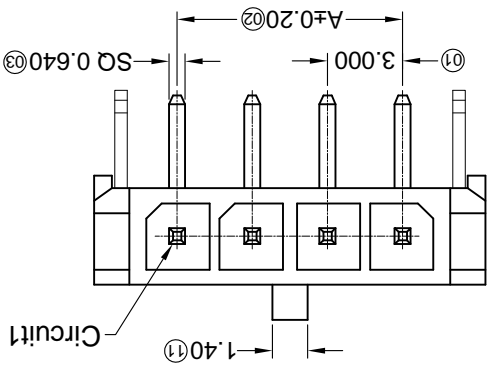
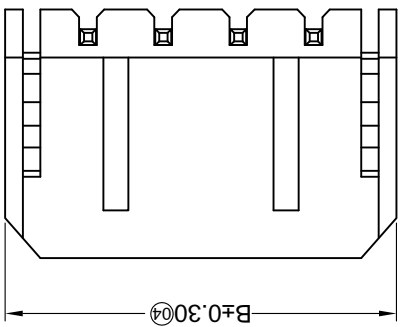
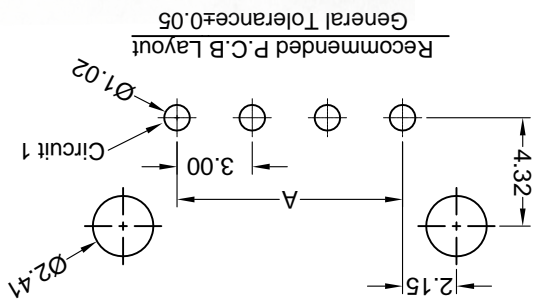

Poles	Dimensions(mm)	
	A	B
01	6.65	18.00
02	3.00	21.00
03	6.00	24.00
04	9.00	27.00
05	12.00	30.00
06	15.00	33.00

PART NO	Material	Material(Pin)	Finish(Pin)	Mates With XKB Housing
X3025WR-XXC-N0SN	PA66 UL 94V-0	Brass	Tin-Plated	X3025H
X3025WR-XXC-LPNS	LCP UL 94V-0			

- ① Series No.
- ② Category: W-water
- ③ Welding Board Angle: R-90°
- ④ Welding Way: Blank-DIP
- ⑤ Row No.-Pin No.: XX-01P-12P
- ⑥ Plug the Pin & Special No.: C-The harpoon
- ⑦ Material: LP-LCP 94V-0;  
N0-PA66 94V-0
- ⑧ Plating Category: SN-Bright tin plating
- ⑨ Color: Blank-Natural Color Black

X3025 W R X - XX C - XX SN XX  
 ① ② ③ ④ ⑤ ⑥ ⑦ ⑧ ⑨

- Voltage rating: 250V AC / DC
- Current rating: 5A AC / DC
- Withstanding voltage: 1500V AC/minute
- Temperature range: -40°C~+105°C
- Insulation resistance: ≥1000MΩ
- Contact resistance: ≤10mΩ
- After environmental testing: ≤20mΩ

**Specifications :**





REVISIONS  
*Authorized Signature(s)*

MARK	DESCRIPTION	DATE	REVISED	APPROVED	UNSPECIFIED TOLERANCES
△ X					L > 63 ± 0.5
△ X					16 < L ≤ 63 ± 0.4
△ X					4 < L ≤ 16 ± 0.3
△ X					L ≤ 4 ± 0.2
					ANGULAR ± 5°

For and on behalf of  
**XKB INDUSTRIAL PRECISION CO., LIMITED**  
 香港星坤工業精密有限公司

**XKB INDUSTRIAL PRECISION CO., LIMITED**

WEIGHT	1.0g
SHEET	1/1
REVISION	A0
SIZE:	A4
UNIT:	mm
VIEW:	
SCALE:	N/A
MODEL TYPE:	X3025WV-XXXXSN
PART NO.:	
3.00mm Crimp Style Connectors	
DWG NO.:	

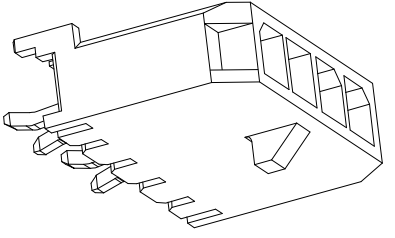
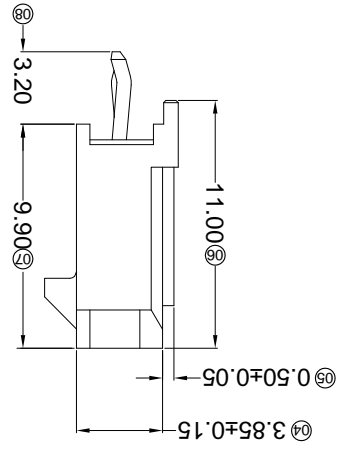
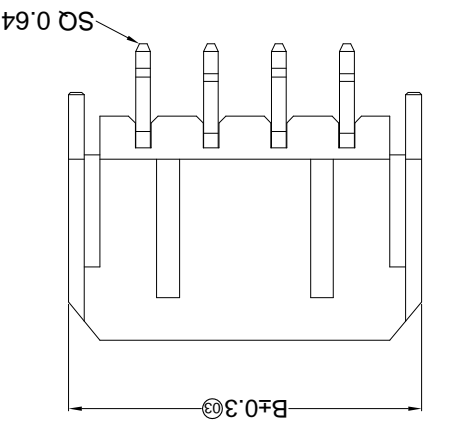
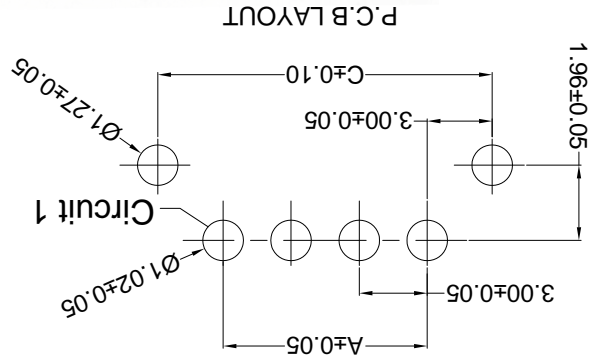

PART NO	Material	Material(Pin)	Finish(Pin)	Mates With XKB Housing
X3025WV-XX-PTS	PBT UL 94V-0	Brass	Tin-Plated	X3025H
X3025WV-XX-46SN	PA46 UL 94V-0			
X3025WV-XX-NOSN	PA66 UL 94V-0			

Poles	A	B	C
02	3.00	9.65	9.00
03	6.00	12.65	12.00
04	9.00	15.65	15.00
05	12.00	18.65	18.00
06	15.00	21.65	21.00
07	18.00	24.65	24.00
08	21.00	27.65	27.00
09	24.00	30.65	30.00
10	27.00	33.65	33.00
11	30.00	36.65	36.00
12	33.00	39.65	39.00

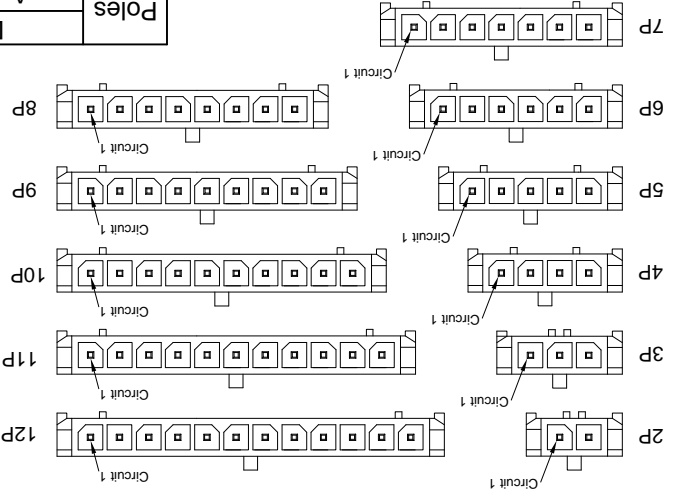

- Specifications :
- ① Voltage rating: 250V AC / DC
  - ② Current rating: 5A AC / DC
  - ③ Category: W-water
  - ④ Welding Board Angle: V- Straight 180°
  - ⑤ Welding Way: Blank-DIP
  - ⑥ Row No.-Pin No.: XX-02P-12P
  - ⑦ Plug the Pin & Special No.:
  - ⑧ Material: 46-PA46 94V-0; PT-PBT 94V-0;
  - ⑨ NO-PA66 94V-0
  - ⑩ Planting Category: SN-Bright tin plating
  - ⑪ Color: Blank-Natural Color
- After environmental testing: ≤20mΩ
- Contact resistance: ≤10mΩ
- Insulation resistance: ≥1000MΩ
- Temperature range: -25°C~+85°C
- Withstanding voltage: 1500V AC/minute

- X3025 W V X-XX X-XX SN XX
- ① Series No.
  - ② Category: W-water
  - ③ Welding Board Angle: V- Straight 180°
  - ④ Welding Way: Blank-DIP
  - ⑤ Row No.-Pin No.: XX-02P-12P
  - ⑥ Plug the Pin & Special No.:
  - ⑦ Material: 46-PA46 94V-0; PT-PBT 94V-0;
  - ⑧ NO-PA66 94V-0
  - ⑨ Planting Category: SN-Bright tin plating
  - ⑩ Color: Blank-Natural Color



REVISIONS  
*Unauthorized Signatures(s)*

MARK	DESCRIPTION	DATE	REVISD	APPROVED	UNSPECIFIED TOLERANCES
△ X					L > 63 ± 0.5
△ X					16 < L ≤ 63 ± 0.4
△ X					4 < L ≤ 16 ± 0.3
					L ≤ 4 ± 0.2
					ANGULAR ± 5°

For and on behalf of  
**XKB INDUSTRIAL PRECISION CO., LIMITED**  
香港星坤工業精密有限公司

**XKB INDUSTRIAL PRECISION CO., LIMITED**

WEIGHT	1.0g
SHEET	1/1
REVISION	A0

APPD	DATE	SIZE: A4
CHKD	DATE	UNIT: mm
DWN	DATE	VIEW: ①
DSND	DATE	SCALE: N/A

MODEL TYPE: X3025WV-XXC-XXSN  
PART NO.:  
3.00 mm Crimp Style Connectors  
DWG NO.:

PART NO	Material	Material(Pin)	Finish(Pin)	Mates With XKB Housing
X3025WV-XXC-LPSN	LCP UL 94V-0	Brass	Tin-Plated	X3025H
X3025WV-XXC-NOSN	PA66 UL 94V-0			

Poles	A	B
12	33.00	39.65
11	30.00	36.65
10	27.00	33.65
9	24.00	30.65
8	21.00	27.65
7	18.00	24.65
6	15.00	21.65
5	12.00	18.65
4	9.00	15.65
3	6.00	12.65
2	3.00	9.65

- ① Series No.
- ② Category:
- ③ W-water
- ④ Welding Board Angle:
- ⑤ V-180°
- ⑥ Welding Way:
- ⑦ Blank-DIP
- ⑧ Row No.-Pin No.
- ⑨ XX-Single row
- ⑩ Special NO.
- ⑪ C-With a harpoon
- ⑫ Material:
- ⑬ LP-LCP 94V-0 NO-PA66 94V-0
- ⑭ Planting Category:
- ⑮ V\*\*All Gold-Plated
- ⑯ G\*\*Gold-Plated Contact
- ⑰ \*01-Gold Flash ; \*02-2u" ; \*03-3u" ; \*05-5u"
- ⑱ \*10-10u" ; \*15-15u" ; \*30-30u" ; \*50-50u"
- ⑳ SN-Bright tin plating 70u"
- ㉑ SN1-Bright tin plating 120u"Min. ;
- ㉒ SW-Fog Tin plating
- ㉓ Color:
- ㉔ Blank-natural color

- Specifications :
- Voltage rating: 250V AC / DC
- Current rating: 5A AC / DC
- Withstanding voltage: 1000V AC/minute
- Temperature range: -25°C~+85°C
- Insulation resistance: ≥1000MΩ
- Contact resistance: ≤10mΩ
- After environmental testing: ≤20mΩ

### P.C.B LAYOUT

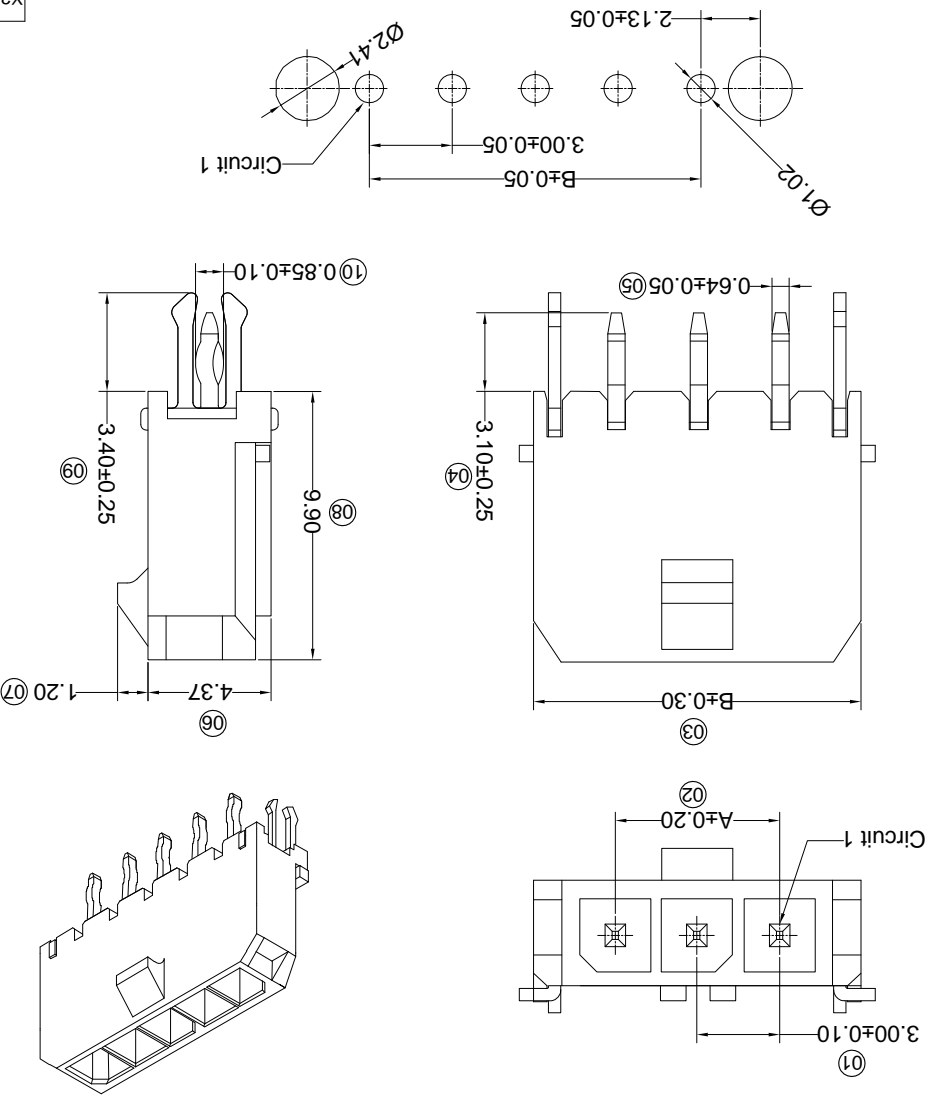

## X-ON Electronics

Largest Supplier of Electrical and Electronic Components

*Click to view similar products for [Headers & Wire Housings](#) category:*

*Click to view products by [XKB](#) manufacturer:*

Other Similar products are found below :

[95000-104TRLF](#) [10135584-644402LF](#) [DF62W-EP2022PCA](#) [95000-106TRLF](#) [DF62W-2022SCA](#) [DF62W-EP2022PC](#) [2203348](#) [DF62W-2022SC](#) [1084018](#) [1029039](#) [1084017](#) [802-10-012-10-002000](#) [1112640](#) [1112639](#) [891-007-9SS-BST1T](#) [000-34000](#) [0008550134](#) [0009482033](#) [0009507031](#) [57102-F02-18ULF](#) [57102-S06-03LF](#) [57202-S52-04LF](#) [PCN6-15S-2.5E](#) [0039019024](#) [58102-G61-06LF](#) [582553-1](#) [0009485154](#) [0009508121](#) [0022285053](#) [0050291907](#) [018731A](#) [LY20-4P-DT1-P1E-BR](#) [02.125.8002.8](#) [60101931](#) [60598-1 \(Cut Strip\)](#) [M1625-3R/100](#) [61062-3](#) [61082-181009](#) [CSU011177004](#) [636-1427](#) [638009-1](#) [641938-9](#) [641991-4](#) [644168-1](#) [644827-2](#) [647662-1](#) [65039-019ELF](#) [65692-001LF](#) [65781-018](#) [65781-047](#)