

# SiT8924

## Automotive AEC-Q100 Oscillator



### Features

- AEC-Q100 with extended temperature range (-55°C to 125°C)
- Frequencies between 1 MHz and 110 MHz accurate to 6 decimal places
- Supply voltage of 1.8V or 2.25V to 3.63V
- Excellent total frequency stability as low as ±25 ppm
- Industry best G-sensitivity of 0.1 PPB/G
- Low power consumption of 3.8 mA typical at 1.8V
- LVCMOS/LVTTL compatible output
- Industry-standard packages: 2.0 x 1.6, 2.5 x 2.0, 3.2 x 2.5, 5.0 x 3.2, 7.0 x 5.0 mm x mm
- RoHS and REACH compliant, Pb-free, Halogen-free and Antimony-free

### Applications

- Automotive, extreme temperature and other high-rel electronics
- Infotainment systems, collision detection devices, and in-vehicle networking
- Power train control



### Electrical Specifications

Table 1. Electrical Characteristics<sup>[1, 2]</sup>

Parameters	Symbol	Min.	Typ.	Max.	Unit	Condition
<b>Frequency Range</b>						
Output Frequency Range	f	1	–	110	MHz	Refer to Table 13 and Table 14 for a list supported frequencies
<b>Frequency Stability and Aging</b>						
Frequency Stability	F_stab	-25	–	+25	ppm	Inclusive of Initial tolerance at 25°C, 1st year aging at 25°C, and variations over operating temperature, rated power supply voltage and load (15 pF ± 10%).
		-30	–	+30	ppm	
		-50	–	+50	ppm	
<b>Operating Temperature Range</b>						
Operating Temperature Range (ambient)	T_use	-40	–	+105	°C	Extended Industrial, AEC-Q100 Grade 2
		-40	–	+125	°C	Automotive, AEC-Q100 Grade 1
		-55	–	+125	°C	Extended Temperature, AEC-Q100
<b>Supply Voltage and Current Consumption</b>						
Supply Voltage	Vdd	1.62	1.8	1.98	V	All voltages between 2.25V and 3.63V including 2.5V, 2.8V, 3.0V and 3.3V are supported.
		2.25	–	3.63	V	
Current Consumption	Idd	–	4.0	4.8	mA	No load condition, f = 20 MHz, Vdd = 2.25V to 3.63V
		–	3.8	4.5	mA	No load condition, f = 20 MHz, Vdd = 1.8V
<b>LVCMOS Output Characteristics</b>						
Duty Cycle	DC	45	–	55	%	All Vdds
Rise/Fall Time	Tr, Tf	–	1.5	3	ns	Vdd = 2.25V - 3.63V, 20% - 80%
		–	1.3	2.5	ns	Vdd = 1.8V, 20% - 80%
Output High Voltage	VOH	90%	–	–	Vdd	IOH = -4 mA (Vdd = 3.0V or 3.3V) IOH = -3 mA (Vdd = 2.8V and Vdd = 2.5V) IOH = -2 mA (Vdd = 1.8V)
Output Low Voltage	VOL	–	–	10%	Vdd	IOL = 4 mA (Vdd = 3.0V or 3.3V) IOL = 3 mA (Vdd = 2.8V and Vdd = 2.5V) IOL = 2 mA (Vdd = 1.8V)
<b>Input Characteristics</b>						
Input High Voltage	VIH	70%	–	–	Vdd	Pin 1, OE
Input Low Voltage	VIL	–	–	30%	Vdd	Pin 1, OE
Input Pull-up Impedance	Z_in	–	100	–	kΩ	Pin 1, OE logic high or logic low
<b>Startup and Resume Timing</b>						
Startup Time	T_start	–	–	10	ms	Measured from the time Vdd reaches 90% of final value
Enable/Disable Time	T_oe	–	–	130	ns	f = 110 MHz. For other frequencies, T_oe = 100 ns + 3 * cycles
<b>Jitter</b>						
RMS Period Jitter	T_jitt	–	1.6	2.5	ps	f = 75 MHz, 2.25V to 3.63V
		–	1.9	3.0	ps	f = 75 MHz, 1.8V
RMS Phase Jitter (random)	T_phj	–	0.5	–	ps	f = 75 MHz, Integration bandwidth = 900 kHz to 7.5 MHz
		–	1.3	–	ps	f = 75 MHz, Integration bandwidth = 12 kHz to 20 MHz

**Notes:**

1. All electrical specifications in the above table are specified with 15 pF output load and for all Vdd(s) unless otherwise stated.
2. The typical value of any parameter in the Electrical Characteristics table is specified for the nominal value of the highest voltage option for that parameter and at 25 °C temperature.

**Table 2. Pin Description**

Pin	Symbol		Functionality
1	OE/NC	Output Enable	H <sup>[3]</sup> : specified frequency output L: output is high impedance. Only output driver is disabled.
		No Connect	Any voltage between 0 and Vdd or Open <sup>[3]</sup> : Specified frequency output. Pin 1 has no function.
2	GND	Power	Electrical ground <sup>[4]</sup>
3	OUT	Output	Oscillator output
4	VDD	Power	Power supply voltage <sup>[4]</sup>

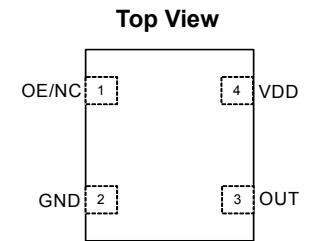

**Figure 1. Pin Assignments**

**Notes:**

- 3. In OE mode, a pull-up resistor of 10kΩ or less is recommended if pin 1 is not externally driven. If pin 1 needs to be left floating, use the NC option.
- 4. A capacitor of value 0.1 μF or higher between Vdd and GND is required.

**Table 3. Absolute Maximum Limits**

Attempted operation outside the absolute maximum ratings may cause permanent damage to the part. Actual performance of the IC is only guaranteed within the operational specifications, not at absolute maximum ratings.

Parameter	Min.	Max.	Unit
Storage Temperature	-65	150	°C
Vdd	-0.5	4	V
Electrostatic Discharge	–	2000	V
Soldering Temperature (follow standard Pb free soldering guidelines)	–	260	°C
Junction Temperature <sup>[5]</sup>	–	150	°C

**Note:**

- 5. Exceeding this temperature for extended period of time may damage the device.

**Table 4. Thermal Consideration<sup>[6]</sup>**

Package	θJA, 4 Layer Board (°C/W)	θJA, 2 Layer Board (°C/W)	θJC, Bottom (°C/W)
7050	142	273	30
5032	97	199	24
3225	109	212	27
2520	117	222	26
2016	152	252	36

**Note:**

- 6. Refer to JESD51 for θJA and θJC definitions, and reference layout used to determine the θJA and θJC values in the above table.

**Table 5. Maximum Operating Junction Temperature<sup>[7]</sup>**

Max Operating Temperature (ambient)	Maximum Operating Junction Temperature
105°C	115°C
125°C	135°C

**Note:**

- 7. Datasheet specifications are not guaranteed if junction temperature exceeds the maximum operating junction temperature.

**Table 6. Environmental Compliance**

Parameter	Condition/Test Method
Mechanical Shock	MIL-STD-883F, Method 2002
Mechanical Vibration	MIL-STD-883F, Method 2007
Temperature Cycle	JESD22, Method A104
Solderability	MIL-STD-883F, Method 2003
Moisture Sensitivity Level	MSL1 @ 260°C

### Test Circuit and Waveform<sup>[8]</sup>

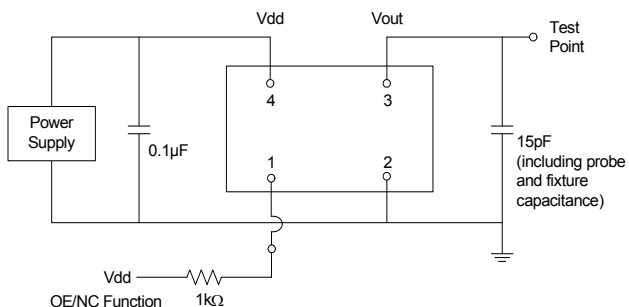

**Figure 2. Test Circuit**

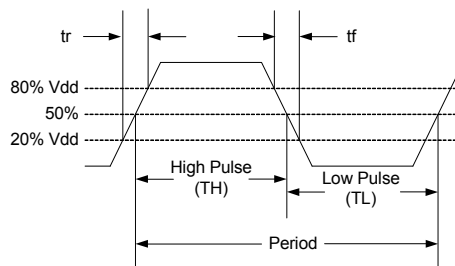
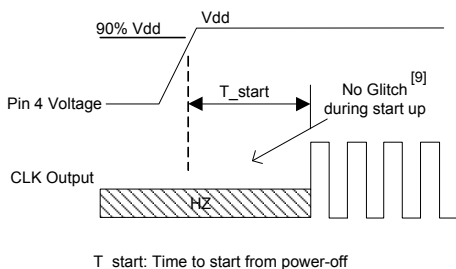

**Figure 3. Waveform**

**Note:**

8. Duty Cycle is computed as Duty Cycle = TH/Period.

### Timing Diagrams



**Figure 4. Startup Timing (OE Mode)**

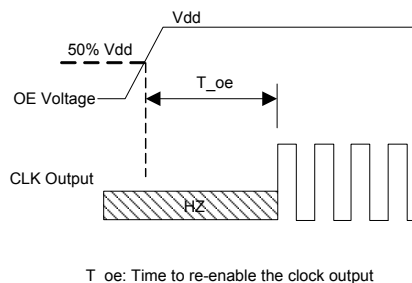

**Figure 5. OE Enable Timing (OE Mode Only)**

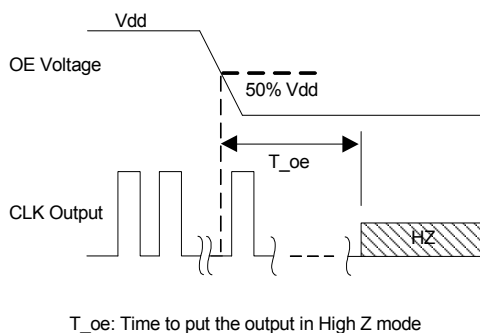

**Figure 6. OE Disable Timing (OE Mode Only)**

**Note:**

<sup>9</sup> SiT8924 has “no runt” pulses and “no glitch” output during startup or resume.

Performance Plots<sup>[10]</sup>

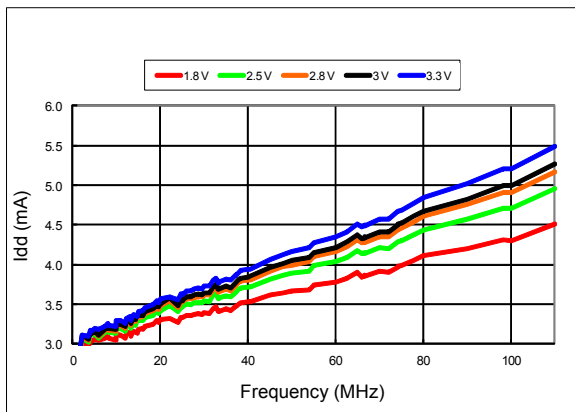

Figure 7. Idd vs Frequency

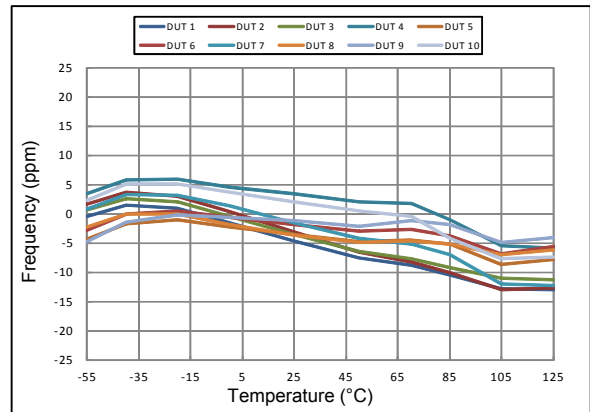

Figure 8. Frequency vs Temperature

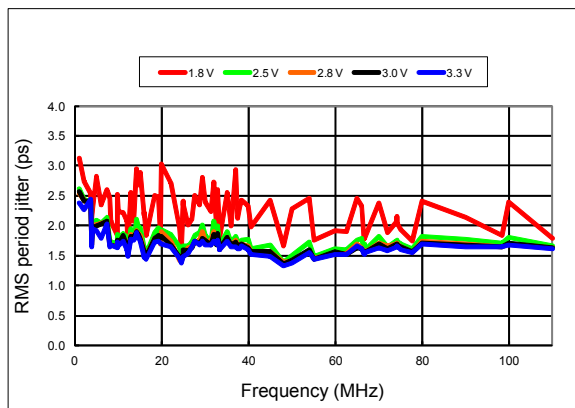

Figure 9. RMS Period Jitter vs Frequency

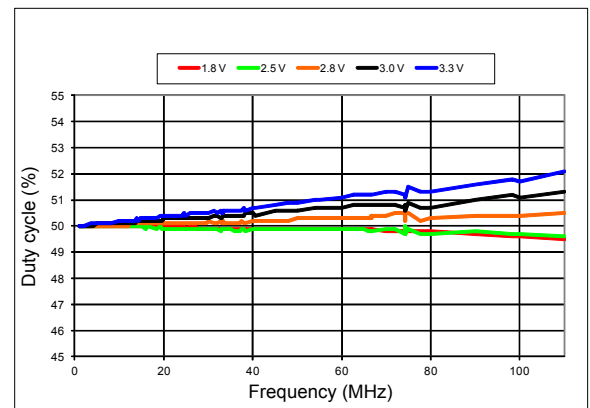

Figure 10. Duty Cycle vs Frequency

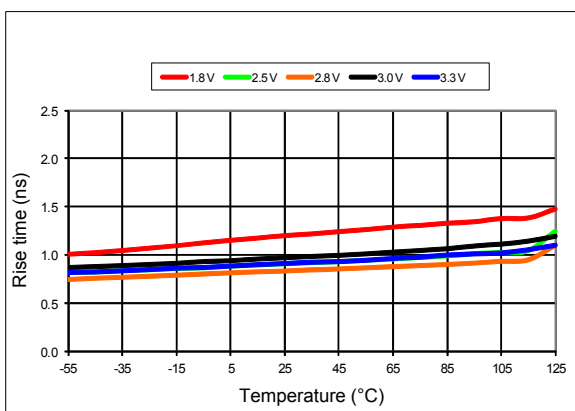

Figure 11. 20%-80% Rise Time vs Temperature

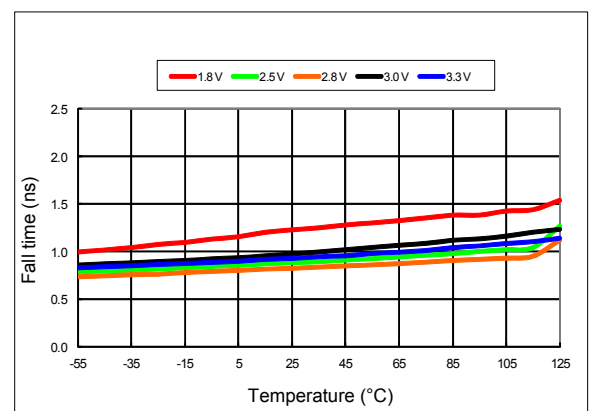
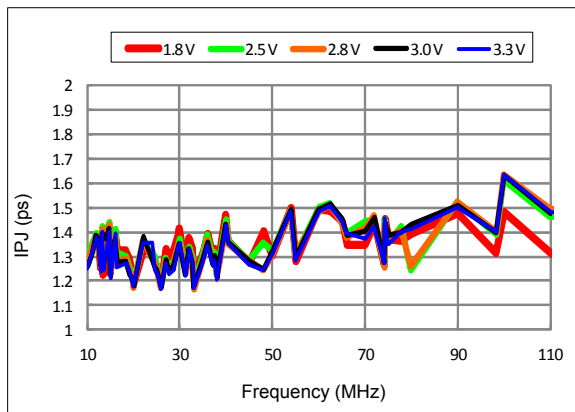
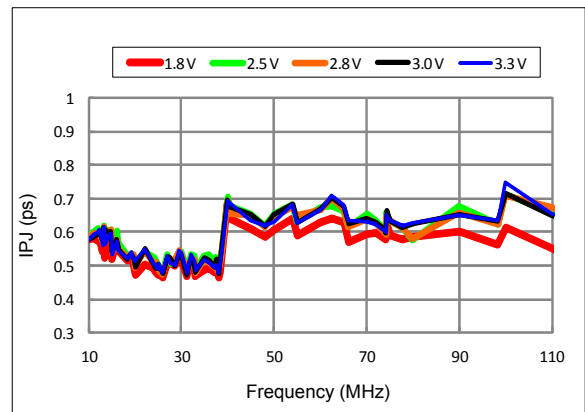

Figure 12. 20%-80% Fall Time vs Temperature

**Performance Plots<sup>[10]</sup>**



**Figure 13. RMS Integrated Phase Jitter Random (12 kHz to 20 MHz) vs Frequency<sup>[11]</sup>**



**Figure 14. RMS Integrated Phase Jitter Random (900 kHz to 7.5 MHz) vs Frequency<sup>[11]</sup>**

**Notes:**

- 10. All plots are measured with 15 pF load at room temperature, unless otherwise stated.
- 11. Phase noise plots are measured with Agilent E5052B signal source analyzer. Integration range is up to 5 MHz for carrier frequencies up to 40 MHz.

### Programmable Drive Strength

The SiT8924 includes a programmable drive strength feature to provide a simple, flexible tool to optimize the clock rise/fall time for specific applications. Benefits from the programmable drive strength feature are:

- Improves system radiated electromagnetic interference (EMI) by slowing down the clock rise/fall time.
- Improves the downstream clock receiver's (RX) jitter by decreasing (speeding up) the clock rise/fall time.
- Ability to drive large capacitive loads while maintaining full swing with sharp edge rates.

For more detailed information about rise/fall time control and drive strength selection, see the SiTime Application Notes section: <http://www.sitime.com/support/application-notes>.

### EMI Reduction by Slowing Rise/Fall Time

Figure 15 shows the harmonic power reduction as the rise/fall times are increased (slowed down). The rise/fall times are expressed as a ratio of the clock period. For the ratio of 0.05, the signal is very close to a square wave. For the ratio of 0.45, the rise/fall times are very close to near-triangular waveform. These results, for example, show that the 11th clock harmonic can be reduced by 35 dB if the rise/fall edge is increased from 5% of the period to 45% of the period.

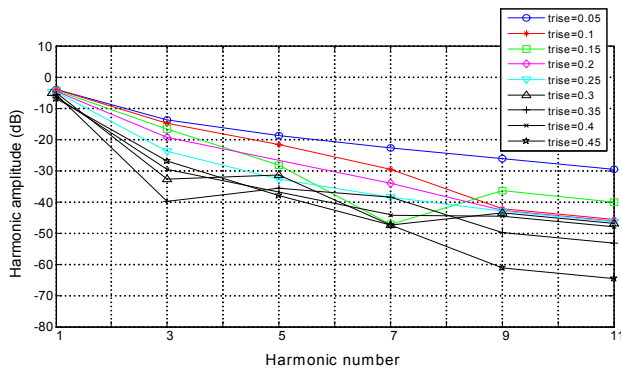

Figure 15. Harmonic EMI reduction as a Function of Slower Rise/Fall Time

### Jitter Reduction with Faster Rise/Fall Time

Power supply noise can be a source of jitter for the downstream chipset. One way to reduce this jitter is to speed up the rise/fall time of the input clock. Some chipsets may also require faster rise/fall time in order to reduce their sensitivity to this type of jitter. Refer to the Rise/Fall Time Tables (Table 7 to Table 11) to determine the proper drive strength.

### High Output Load Capability

The rise/fall time of the input clock varies as a function of the actual capacitive load the clock drives. At any given drive strength, the rise/fall time becomes slower as the output load increases. As an example, for a 3.3V SiT8924 device with default drive strength setting, the typical rise/fall time is 1ns for 15 pF output load. The typical rise/fall time slows down to 2.6 ns when the output load increases to 45 pF. One can choose to speed up the rise/fall time to 1.83 ns by then increasing the drive strength setting on the SiT8924.

The SiT8924 can support up to 60 pF in maximum capacitive loads with drive strength settings. Refer to the Rise/Fall Time Tables (Table 7 to 11) to determine the proper drive strength for the desired combination of output load vs. rise/fall time

### SiT8924 Drive Strength Selection

Tables 7 through 11 define the rise/fall time for a given capacitive load and supply voltage.

1. Select the table that matches the SiT8924 nominal supply voltage (1.8V, 2.5V, 2.8V, 3.0V, 3.3V).
2. Select the capacitive load column that matches the application requirement (5 pF to 60 pF)
3. Under the capacitive load column, select the desired rise/fall times.
4. The left-most column represents the part number code for the corresponding drive strength.
5. Add the drive strength code to the part number for ordering purposes.

### Calculating Maximum Frequency

Based on the rise and fall time data given in Tables 7 through 11, the maximum frequency the oscillator can operate with guaranteed full swing of the output voltage over temperature can be calculated as follows:

$$\text{Max Frequency} = \frac{1}{5 \times \text{Trf}_{20/80}}$$

where Trf<sub>20/80</sub> is the typical value for 20%-80% rise/fall time.

### Example 1

Calculate f<sub>MAX</sub> for the following condition:

- V<sub>dd</sub> = 1.8V (Table 7)
- Capacitive Load: 30 pF
- Desired Tr/f time = 3 ns (rise/fall time part number code = E)

Part number for the above example:

SiT8924AIE12-18E-66.666660



Drive strength code is inserted here. Default setting is “-”

**Rise/Fall Time (20% to 80%) vs C<sub>LOAD</sub> Tables**

**Table 7. V<sub>dd</sub> = 1.8V Rise/Fall Times for Specific C<sub>LOAD</sub>**

Rise/Fall Time Typ (ns)					
Drive Strength \ C <sub>LOAD</sub>	5 pF	15 pF	30 pF	45 pF	60 pF
L	6.16	11.61	22.00	31.27	39.91
A	3.19	6.35	11.00	16.01	21.52
R	2.11	4.31	7.65	10.77	14.47
B	1.65	3.23	5.79	8.18	11.08
T	0.93	1.91	3.32	4.66	6.48
E	0.78	1.66	2.94	4.09	5.74
U	0.70	1.48	2.64	3.68	5.09
F or "-": default	0.65	1.30	2.40	3.35	4.56

**Table 8. V<sub>dd</sub> = 2.5V Rise/Fall Times for Specific C<sub>LOAD</sub>**

Rise/Fall Time Typ (ns)					
Drive Strength \ C <sub>LOAD</sub>	5 pF	15 pF	30 pF	45 pF	60 pF
L	4.13	8.25	12.82	21.45	27.79
A	2.11	4.27	7.64	11.20	14.49
R	1.45	2.81	5.16	7.65	9.88
B	1.09	2.20	3.88	5.86	7.57
T	0.62	1.28	2.27	3.51	4.45
E or "-": default	0.54	1.00	2.01	3.10	4.01
U	0.43	0.96	1.81	2.79	3.65
F	0.34	0.88	1.64	2.54	3.32

**Table 9. V<sub>dd</sub> = 2.8V Rise/Fall Times for Specific C<sub>LOAD</sub>**

Rise/Fall Time Typ (ns)					
Drive Strength \ C <sub>LOAD</sub>	5 pF	15 pF	30 pF	45 pF	60 pF
L	3.77	7.54	12.28	19.57	25.27
A	1.94	3.90	7.03	10.24	13.34
R	1.29	2.57	4.72	7.01	9.06
B	0.97	2.00	3.54	5.43	6.93
T	0.55	1.12	2.08	3.22	4.08
E or "-": default	0.44	1.00	1.83	2.82	3.67
U	0.34	0.88	1.64	2.52	3.30
F	0.29	0.81	1.48	2.29	2.99

**Table 10. V<sub>dd</sub> = 3.0V Rise/Fall Times for Specific C<sub>LOAD</sub>**

Rise/Fall Time Typ (ns)					
Drive Strength \ C <sub>LOAD</sub>	5 pF	15 pF	30 pF	45 pF	60 pF
L	3.60	7.21	11.97	18.74	24.30
A	1.84	3.71	6.72	9.86	12.68
R	1.22	2.46	4.54	6.76	8.62
B	0.89	1.92	3.39	5.20	6.64
T or "-": default	0.51	1.00	1.97	3.07	3.90
E	0.38	0.92	1.72	2.71	3.51
U	0.30	0.83	1.55	2.40	3.13
F	0.27	0.76	1.39	2.16	2.85

**Table 11. V<sub>dd</sub> = 3.3V Rise/Fall Times for Specific C<sub>LOAD</sub>**

Rise/Fall Time Typ (ns)					
Drive Strength \ C <sub>LOAD</sub>	5 pF	15 pF	30 pF	45 pF	60 pF
L	3.39	6.88	11.63	17.56	23.59
A	1.74	3.50	6.38	8.98	12.19
R	1.16	2.33	4.29	6.04	8.34
B	0.81	1.82	3.22	4.52	6.33
T or "-": default	0.46	1.00	1.86	2.60	3.84
E	0.33	0.87	1.64	2.30	3.35
U	0.28	0.79	1.46	2.05	2.93
F	0.25	0.72	1.31	1.83	2.61

### Pin 1 Configuration Options (OE or NC)

Pin 1 of the SiT8924 can be factory-programmed to support two modes: Output Enable (OE) or No Connect (NC).

#### Output Enable (OE) Mode

In the OE mode, applying logic low to the OE pin only disables the output driver and puts it in Hi-Z mode. The core of the device continues to operate normally. Power consumption is reduced due to the inactivity of the output. When the OE pin is pulled High, the output is typically enabled in <math><1\mu\text{s}</math>.

#### No Connect (NC) Mode

In the NC mode, the device always operates in its normal mode and output the specified frequency regardless of the logic level on pin 1.

Table 12 below summarizes the key relevant parameters in the operation of the device in OE or NC mode.

**Table 12. OE vs. NC**

	OE	NC
Active current 20 MHz (max, 1.8V)	4.5 mA	4.5 mA
OE disable current (max, 1.8V)	3.8 mA	N/A
OE enable time at 110 MHz (max)	130 ns	N/A
Output driver in OE disable	High Z	N/A

#### Output on Startup and OE Enable

The SiT8924 comes with gated output. Its clock output is accurate to the rated frequency stability within the first pulse from initial device startup or when the output driver is enabled.

In addition, the SiT8924 supports “no runt” pulses and “no glitch” output during startup or when the device output driver

is enabled as shown in the waveform captures in Figure 16 and Figure 17.



**Figure 16. Startup Waveform vs. Vdd**

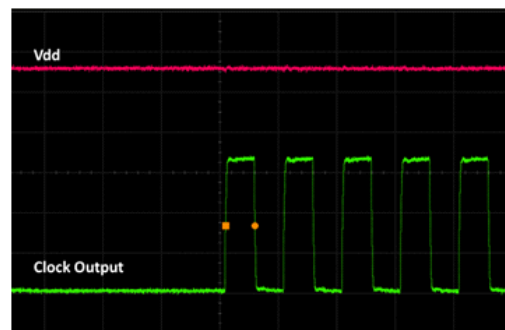

**Figure 17. Startup Waveform vs. Vdd (Zoomed-in View of Figure 16)**

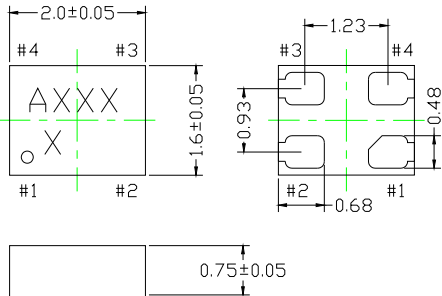
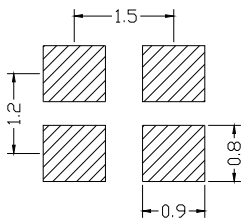
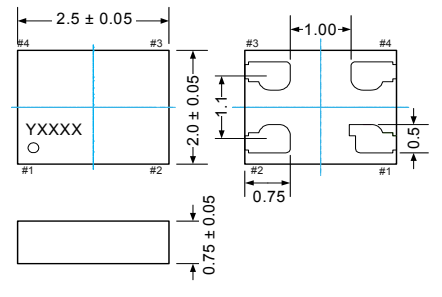
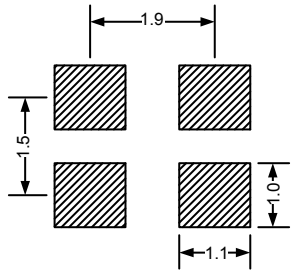
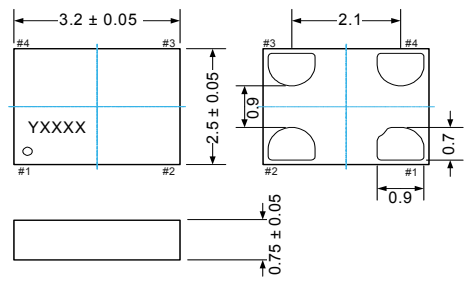
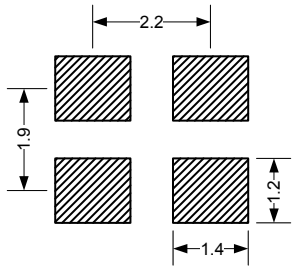
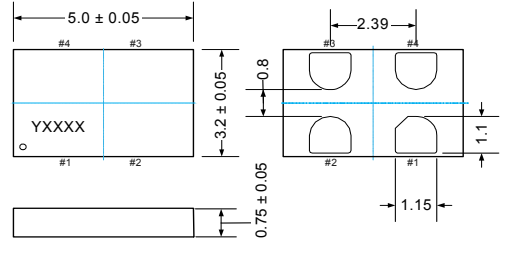
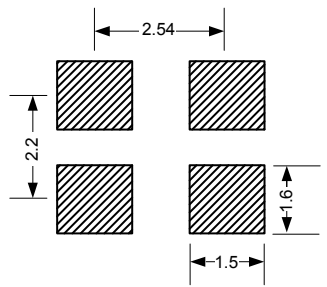

### Dimensions and Patterns

Package Size – Dimensions (Unit: mm) <sup>[12]</sup>	Recommended Land Pattern (Unit: mm) <sup>[13]</sup>
<p><b>2.0 x 1.6 x 0.75 mm</b></p>  <p>Top view dimensions: 2.0 ± 0.05 mm (width), 1.6 ± 0.05 mm (height). Pin locations: #1, #2, #3, #4. Markings: AXXX, X. Bottom view dimensions: 0.93 mm (pin width), 1.23 mm (pin pitch), 0.68 mm (pin width), 0.48 mm (pin height). Side view dimension: 0.75 ± 0.05 mm (thickness).</p> <p>Recommended Land Pattern: 1.5 mm (width), 1.2 mm (height), 0.9 mm (pitch), 0.8 mm (height).</p>	 <p>Recommended Land Pattern: 1.5 mm (width), 1.2 mm (height), 0.9 mm (pitch), 0.8 mm (height).</p>
<p><b>2.5 x 2.0 x 0.75 mm</b></p>  <p>Top view dimensions: 2.5 ± 0.05 mm (width), 2.0 ± 0.05 mm (height). Pin locations: #1, #2, #3, #4. Markings: YXXXX, X. Bottom view dimensions: 1.00 mm (pin pitch), 0.75 mm (pin width), 0.5 mm (pin height). Side view dimension: 0.75 ± 0.05 mm (thickness).</p> <p>Recommended Land Pattern: 1.9 mm (width), 1.5 mm (height), 1.1 mm (pitch), 1.0 mm (height).</p>	 <p>Recommended Land Pattern: 1.9 mm (width), 1.5 mm (height), 1.1 mm (pitch), 1.0 mm (height).</p>
<p><b>3.2 x 2.5 x 0.75 mm</b></p>  <p>Top view dimensions: 3.2 ± 0.05 mm (width), 2.5 ± 0.05 mm (height). Pin locations: #1, #2, #3, #4. Markings: YXXXX, X. Bottom view dimensions: 2.1 mm (pin pitch), 0.9 mm (pin width), 0.7 mm (pin height). Side view dimension: 0.75 ± 0.05 mm (thickness).</p> <p>Recommended Land Pattern: 2.2 mm (width), 1.9 mm (height), 1.4 mm (pitch), 1.2 mm (height).</p>	 <p>Recommended Land Pattern: 2.2 mm (width), 1.9 mm (height), 1.4 mm (pitch), 1.2 mm (height).</p>
<p><b>5.0 x 3.2 x 0.75 mm</b></p>  <p>Top view dimensions: 5.0 ± 0.05 mm (width), 3.2 ± 0.05 mm (height). Pin locations: #1, #2, #3, #4. Markings: YXXXX, X. Bottom view dimensions: 2.39 mm (pin pitch), 0.8 mm (pin width), 1.1 mm (pin height). Side view dimension: 0.75 ± 0.05 mm (thickness).</p> <p>Recommended Land Pattern: 2.54 mm (width), 2.2 mm (height), 1.5 mm (pitch), 1.6 mm (height).</p>	 <p>Recommended Land Pattern: 2.54 mm (width), 2.2 mm (height), 1.5 mm (pitch), 1.6 mm (height).</p>

**Dimensions and Patterns**

Package Size – Dimensions (Unit: mm) <sup>[12]</sup>	Recommended Land Pattern (Unit: mm) <sup>[13]</sup>
<p><b>7.0 x 5.0 x 0.90 mm</b></p>	

**Notes:**

- 12. Top marking: Y denotes manufacturing origin and XXXX denotes manufacturing lot number. The value of “Y” will depend on the assembly location of the device.
- 13. A capacitor of value 0.1  $\mu$ F or higher between Vdd and GND is required.

### Ordering Information

The Part No. Guide is for reference only. To customize and build an exact part number, use the SiTime [Part Number Generator](#).

SiT8924AA-12-18E-66.666666D

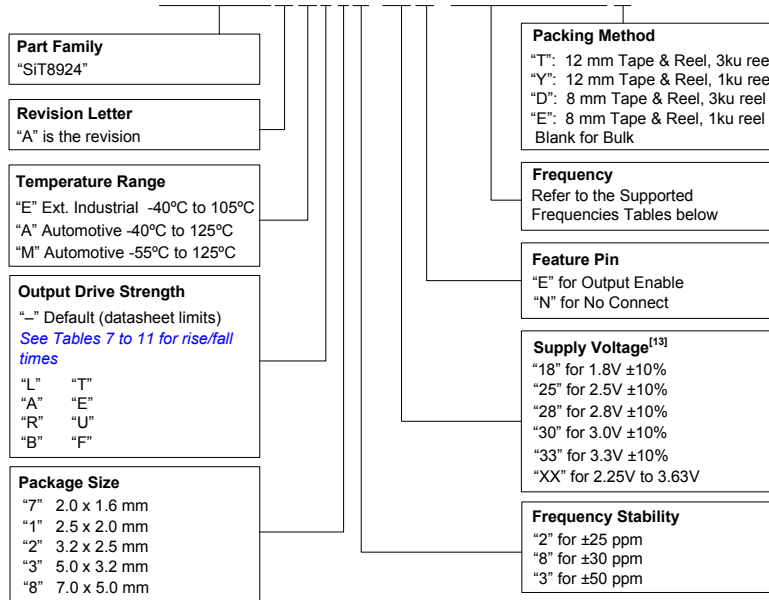

**Note:**

13. The voltage portion of the SiT8924 part number consists of two characters that denote the specific supply voltage of the device. The SiT8924 supports either 1.8V ±10% or any voltage between 2.25V and 3.62V. In the 1.8V mode, one can simply insert 18 in the part number. In the 2.5V to 3.3V mode, two digits such as 18, 25 or 33 can be used in the part number to reflect the desired voltage. Alternatively, "XX" can be used to indicate the entire operating voltage range from 2.25V to 3.63V.

**Table 13. Supported Frequencies**  
(-40°C to ±105°C or -40°C to ±125°C)<sup>[14, 15]</sup>

Frequency Range	
Min.	Max.
1.000000 MHz	61.222999 MHz
61.674001 MHz	69.795999 MHz
70.485001 MHz	79.062999 MHz
79.162001 MHz	81.427999 MHz
82.232001 MHz	91.833999 MHz
92.155001 MHz	94.248999 MHz
94.430001 MHz	94.874999 MHz
94.994001 MHz	97.713999 MHz
98.679001 MHz	110.000000 MHz

**Table 14. Supported Frequencies**  
(-55°C to ±125°C)<sup>[14, 15]</sup>

Frequency Range	
Min.	Max.
1.000000 MHz	61.222999 MHz
61.674001 MHz	69.239999 MHz
70.827001 MHz	78.714999 MHz
79.561001 MHz	80.159999 MHz
80.174001 MHz	80.779999 MHz
82.632001 MHz	91.833999 MHz
95.474001 MHz	96.191999 MHz
96.209001 MHz	96.935999 MHz
99.158001 MHz	110.000000 MHz

**Notes:**

14. Any frequency within the min and max values in the above tables are supported with 6 decimal places of accuracy.  
15. Please contact SiTime for frequencies that are not listed in the tables above.

**Table 15. Ordering Codes for Supported Tape & Reel Packing Method**

Device Size (mm x mm)	16 mm T&R (3ku)	16 mm T&R (1ku)	12 mm T&R (3ku)	12 mm T&R (1ku)	8 mm T&R (3ku)	8 mm T&R (1ku)
2.0 x 1.6	–	–	–	–	D	E
2.5 x 2.0	–	–	–	–	D	E
3.2 x 2.5	–	–	–	–	D	E
5.0 x 3.2	–	–	T	Y	–	–
7.0 x 5.0	T	Y	–	–	–	–

**Table 16. Additional Information**

Document	Description	Download Link
Time Machine II	MEMS oscillator programmer	<a href="http://www.sitime.com/support/time-machine-oscillator-programmer">http://www.sitime.com/support/time-machine-oscillator-programmer</a>
Field Programmable Oscillators	Devices that can be programmable in the field by Time Machine II	<a href="http://www.sitime.com/products/field-programmable-oscillators">http://www.sitime.com/products/field-programmable-oscillators</a>
Manufacturing Notes	Tape & Reel dimension, reflow profile and other manufacturing related info	<a href="http://www.sitime.com/component/docman/doc_download/243-manufacturing-notes-for-sitime-oscillators">http://www.sitime.com/component/docman/doc_download/243-manufacturing-notes-for-sitime-oscillators</a>
Qualification Reports	RoHS report, reliability reports, composition reports	<a href="http://www.sitime.com/support/quality-and-reliability">http://www.sitime.com/support/quality-and-reliability</a>
Performance Reports	Additional performance data such as phase noise, current consumption and jitter for selected frequencies	<a href="http://www.sitime.com/support/performance-measurement-report">http://www.sitime.com/support/performance-measurement-report</a>
Termination Techniques	Termination design recommendations	<a href="http://www.sitime.com/support/application-notes">http://www.sitime.com/support/application-notes</a>
Layout Techniques	Layout recommendations	<a href="http://www.sitime.com/support/application-notes">http://www.sitime.com/support/application-notes</a>

## Revision History

**Table 17. Datasheet Version and Change Log**

Version	Release Date	Change Summary
0.9	1/24/2013	Preliminary
0.95	11/28/13	<ul style="list-style-type: none"> <li>Added supported frequency table</li> <li>Added <math>\pm 20</math> ppm option</li> <li>Added No Connect (NC) option for pin 1</li> <li>Updated thermal consideration table</li> <li>Added Maximum Operating Junction Temperature table</li> <li>Added timing diagram, test circuits and waveform diagrams</li> <li>Added performance plots</li> <li>Added programmable drive strength options</li> <li>Added pin 1 option section (OE vs NC)</li> <li>Updated order info section</li> <li>Added revision history</li> <li>Added LifeTime Warranty icon in the feature section</li> </ul>
0.96	1/24/14	<ul style="list-style-type: none"> <li>Added <math>\pm 30</math> ppm</li> <li>Additional corrections in spelling and grammar.</li> </ul>
0.97	1/28/14	<ul style="list-style-type: none"> <li>Added support for <math>-55^{\circ}\text{C}</math> to <math>125^{\circ}\text{C}</math></li> </ul>
1.0	5/28/15	<ul style="list-style-type: none"> <li>Final production release</li> <li>Revised Timing Diagrams</li> <li>Fixed error link</li> <li>Revised 2016 package diagram</li> </ul>
1.01	6/18/15	<ul style="list-style-type: none"> <li>Added 16 mm T&amp;R information to Table 15</li> <li>Revised 12 mm T&amp;R information to Table 15</li> </ul>

© SiTime Corporation 2015. The information contained herein is subject to change at any time without notice. SiTime assumes no responsibility or liability for any loss, damage or defect of a Product which is caused in whole or in part by (i) use of any circuitry other than circuitry embodied in a SiTime product, (ii) misuse or abuse including static discharge, neglect or accident, (iii) unauthorized modification or repairs which have been soldered or altered during assembly and are not capable of being tested by SiTime under its normal test conditions, or (iv) improper installation, storage, handling, warehousing or transportation, or (v) being subjected to unusual physical, thermal, or electrical stress.

**Disclaimer:** SiTime makes no warranty of any kind, express or implied, with regard to this material, and specifically disclaims any and all express or implied warranties, either in fact or by operation of law, statutory or otherwise, including the implied warranties of merchantability and fitness for use or a particular purpose, and any implied warranty arising from course of dealing or usage of trade, as well as any common-law duties relating to accuracy or lack of negligence, with respect to this material, any SiTime product and any product documentation. Products sold by SiTime are not suitable or intended to be used in a life support application or component, to operate nuclear facilities, or in other mission critical applications where human life may be involved or at stake. All sales are made conditioned upon compliance with the critical uses policy set forth below.

**CRITICAL USE EXCLUSION POLICY**  
BUYER AGREES NOT TO USE SITIME'S PRODUCTS FOR ANY APPLICATION OR IN ANY COMPONENTS USED IN LIFE SUPPORT DEVICES OR TO OPERATE NUCLEAR FACILITIES OR FOR USE IN OTHER MISSION-CRITICAL APPLICATIONS OR COMPONENTS WHERE HUMAN LIFE OR PROPERTY MAY BE AT STAKE.

SiTime owns all rights, title and interest to the intellectual property related to SiTime's products, including any software, firmware, copyright, patent, or trademark. The sale of SiTime products does not convey or imply any license under patent or other rights. SiTime retains the copyright and trademark rights in all documents, catalogs and plans supplied pursuant to or ancillary to the sale of products or services by SiTime. Unless otherwise agreed to in writing by SiTime, any reproduction, modification, translation, compilation, or representation of this material shall be strictly prohibited.

# Supplemental Information

The Supplemental Information section is not part of the datasheet and is for informational purposes only.

# Silicon MEMS Outperforms Quartz

## Best Reliability

Silicon is inherently more reliable than quartz. Unlike quartz suppliers, SiTime has in-house MEMS and analog CMOS expertise, which allows SiTime to develop the most reliable products. Figure 1 shows a comparison with quartz technology.

### Why is SiTime Best in Class:

- SiTime’s MEMS resonators are vacuum sealed using an advanced EpiSeal™ process, which eliminates foreign particles and improves long term aging and reliability
- World-class MEMS and CMOS design expertise

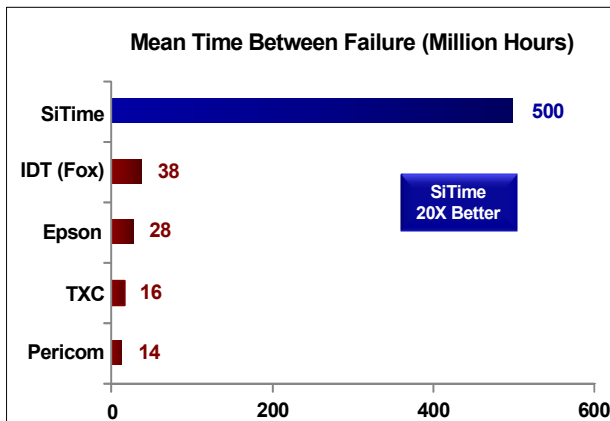

Figure 1. Reliability Comparison<sup>[1]</sup>

## Best Aging

Unlike quartz, MEMS oscillators have excellent long term aging performance which is why every new SiTime product specifies 10-year aging. A comparison is shown in Figure 2.

### Why is SiTime Best in Class:

- SiTime’s MEMS resonators are vacuum sealed using an advanced EpiSeal process, which eliminates foreign particles and improves long term aging and reliability
- Inherently better immunity of electrostatically driven MEMS resonator

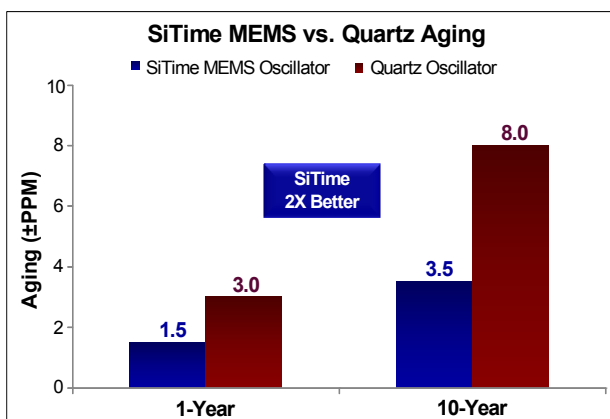

Figure 2. Aging Comparison<sup>[2]</sup>

## Best Electro Magnetic Susceptibility (EMS)

SiTime’s oscillators in plastic packages are up to 54 times more immune to external electromagnetic fields than quartz oscillators as shown in Figure 3.

### Why is SiTime Best in Class:

- Internal differential architecture for best common mode noise rejection
- Electrostatically driven MEMS resonator is more immune to EMS

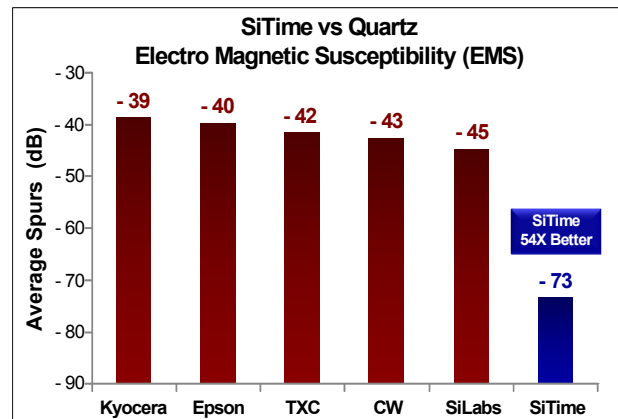

Figure 3. Electro Magnetic Susceptibility (EMS)<sup>[3]</sup>

## Best Power Supply Noise Rejection

SiTime’s MEMS oscillators are more resilient against noise on the power supply. A comparison is shown in Figure 4.

### Why is SiTime Best in Class:

- On-chip regulators and internal differential architecture for common mode noise rejection
- Best analog CMOS design expertise

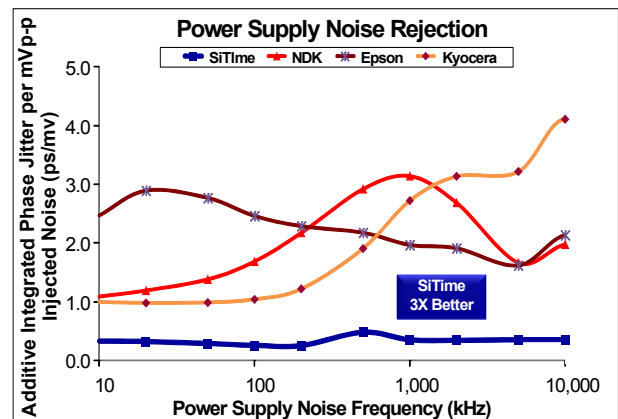

Figure 4. Power Supply Noise Rejection<sup>[4]</sup>

## Best Vibration Robustness

High-vibration environments are all around us. All electronics, from handheld devices to enterprise servers and storage systems are subject to vibration. Figure 5 shows a comparison of vibration robustness.

### Why is SiTime Best in Class:

- The moving mass of SiTime’s MEMS resonators is up to 3000 times smaller than quartz
- Center-anchored MEMS resonator is the most robust design

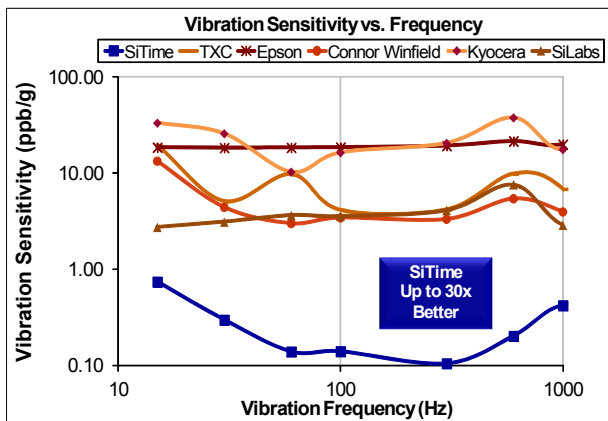

Figure 5. Vibration Robustness<sup>[5]</sup>

## Best Shock Robustness

SiTime’s oscillators can withstand at least 50,000 g shock. They all maintain their electrical performance in operation during shock events. A comparison with quartz devices is shown in Figure 6.

### Why is SiTime Best in Class:

- The moving mass of SiTime’s MEMS resonators is up to 3000 times smaller than quartz
- Center-anchored MEMS resonator is the most robust design

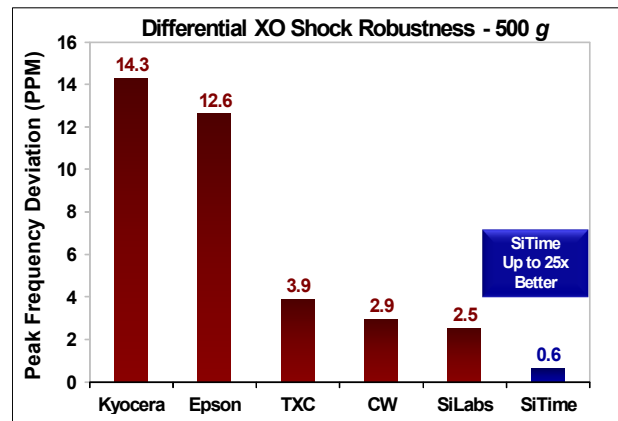

Figure 6. Shock Robustness<sup>[6]</sup>

### Notes:

1. Data Source: Reliability documents of named companies.
2. Data source: SiTime and quartz oscillator devices datasheets.
3. Test conditions for Electro Magnetic Susceptibility (EMS):
  - According to IEC EN61000-4.3 (Electromagnetic compatibility standard)
  - Field strength: 3V/m
  - Radiated signal modulation: AM 1 kHz at 80% depth
  - Carrier frequency scan: 80 MHz – 1 GHz in 1% steps
  - Antenna polarization: Vertical
  - DUT position: Center aligned to antenna

**Devices used in this test:**  
 SiTime, SiT9120AC-1D2-33E156.250000 - MEMS based - 156.25 MHz  
 Epson, EG-2102CA 156.2500M-PHPAL3 - SAW based - 156.25 MHz  
 TXC, BB-156.250MBE-T - 3rd Overtone quartz based - 156.25 MHz  
 Kyocera, KC7050T156.250P30E00 - SAW based - 156.25 MHz  
 Connor Winfield (CW), P123-156.25M - 3rd overtone quartz based - 156.25 MHz  
 SiLabs, Si590AB-BDG - 3rd overtone quartz based - 156.25 MHz
4. 50 mV pk-pk Sinusoidal voltage.
 

**Devices used in this test:**  
 SiTime, SiT8208AI-33-33E-25.000000, MEMS based - 25 MHz  
 NDK, NZ2523SB-25.6M - quartz based - 25.6 MHz  
 Kyocera, KC2016B25MOC1GE00 - quartz based - 25 MHz  
 Epson, SG-310SCF-25M0-MB3 - quartz based - 25 MHz
5. **Devices used in this test:** same as EMS test stated in Note 3.
6. Test conditions for shock test:
  - MIL-STD-883F Method 2002
  - Condition A: half sine wave shock pulse, 500-g, 1ms
  - Continuous frequency measurement in 100 μs gate time for 10 seconds

**Devices used in this test:** same as EMS test stated in Note 3
7. Additional data, including setup and detailed results, is available upon request to qualified customers. Please contact [productsupport@sitime.com](mailto:productsupport@sitime.com).



# Document Feedback Form



The Smart Timing Choice™

SiTime values your input in improving our documentation. Click [here](#) for our online feedback form or fill out and email the form below to [productsupport@sitime.com](mailto:productsupport@sitime.com).

1. Does the Electrical Characteristics table provide complete information? Yes No

If No, what parameters are missing?

---

2. Is the organization of this document easy to follow? Yes No

If "No," please suggest improvements that we can make:

---

3. Is there any application specific information that you would like to see in this document? (Check all that apply)

EMI Termination recommendations Shock and vibration performance Other

If "Other," please specify:

---

4. Are there any errors in this document? Yes No

If "Yes", please specify (what and where):

---

5. Do you have additional recommendations for this document?

---

Name \_\_\_\_\_

Title \_\_\_\_\_

Company \_\_\_\_\_

Address \_\_\_\_\_

City / State or Province / Postal Code / Country \_\_\_\_\_

Telephone \_\_\_\_\_

Application \_\_\_\_\_

Would you like a reply? Yes No

Thank you for your feedback. Please click the email icon in your Adobe Reader tool bar and send to [productsupport@sitime.com](mailto:productsupport@sitime.com). Or you may use our [online feedback form](#).

## X-ON Electronics

Largest Supplier of Electrical and Electronic Components

*Click to view similar products for [Standard Clock Oscillators](#) category:*

*Click to view products by [SiTime](#) manufacturer:*

Other Similar products are found below :

[EP1400SJTSC-125.000M](#) [601137](#) [601252](#) [CSX750FBC-24.000M-UT](#) [CSX750FBC-33.333M-UT](#) [CSX750FCC-3.6864M-UT](#) [F335-12](#) [F335-25](#) [F535L-50](#) [DSC506-03FM2](#) [ASA-20.000MHZ-L-T](#) [ASA-25.000MHZ-L-T](#) [ASA-27.000MHZ-L-T](#) [ASV-20.000MHZ-LR-T](#) [ECS-2018-160-BN-TR](#) [EL13C7-H2F-125.00M](#) [MXO45HS-2C-66.6666MHZ](#) [NBXDBB017LN1TAG](#) [NBXHBA019LN1TAG](#) [SiT1602BI-22-33E-50.000000E](#) [SIT8003AC-11-33S-2.04800X](#) [SiT8256AC-23-33E-156.250000X](#) [SIT8918AA-11-33S-50.000000G](#) [SM4420TEV-40.0M-T1K](#) [SMA4306-TL-H](#) [F335-24](#) [F335-40](#) [F335-50](#) [F535L-10](#) [F535L-12](#) [F535L-16](#) [F535L-24](#) [F535L-27](#) [F535L-48](#) [PE7744DW-100.0M](#) [CSX750FBC-20.000M-UT](#) [CSX-750FBC33333000T](#) [CSX750FBC-4.000M-UT](#) [CSX750FBC-7.3728M-UT](#) [CSX750FBC-8.000M-UT](#) [CSX-750FCC14745600T](#) [CSX750FCC-16.000M-UT](#) [CSX-750FCC40000000T](#) [CSX750FCC-4.000M-UT](#) [ASA-22.000MHZ-L-T](#) [ASA2-26.000MHZ-L-T](#) [ASA-40.000MHZ-L-T](#) [ASA-48.000MHZ-L-T](#) [ASA-60.000MHZ-L-T](#) [ASF1-3.686MHZ-N-K-S](#)