

Multilayer Chip Ferrite Bead



◆ **Features**

- 1、 Internal silver printed layers and magnetic shielded structures to minimize crosstalk
- 2、 It has sharp impedance characteristics at desirable frequency and does not affect the signal frequency
- 3、 SMD Type & suitable for reflow and wave soldering
- 4、 Four types material and wide range of impedance values for various applications
- 5、 Excellent solderability and heat resistance
- 6、 RoHS Compliant.



◆ **Application**

Filtering between analog and digital circuitry, clock Generation circuitry, I/O interconnects, isolation between RF noisy circuits and logic devices susceptible to functional degradation, power supply filtering to prevent conducted RF energy from corrupting the power generation circuitry, high frequency EMI prevention of computer, printers, VCRs, TVs and portable telephones.

◆ **PRODUCT IDENTIFICATION**

CMBM 1608 K 601 A S P
(1) (2) (3) (4) (5) (6) (7)

- (1) Series Type
- (2) Chip Size (mm) :Length X Width
- (3) Material Code
- (4) Nominal Impedance:601=600Ω;
102=1000Ω
- (5) Rated Curren: A=50mA; B=100mA;C=150mA;
D=200mA;E=300mA;F=400mA;
G=500mA;H=600mA;I=700mA;
J=800mA;K=900mA;L=1000mA.
- (6) Company Code
- (7) Packaging: E- Embossed plastic tape, 7" reel
P – Embossed paper tape, 7" reel

◆ **Dimensions Unit: mm**

Size(EIA)	L	W	T	E
1608(0603)	1.60±0.150	0.80±0.150	0.80±0.150	0.30±0.20

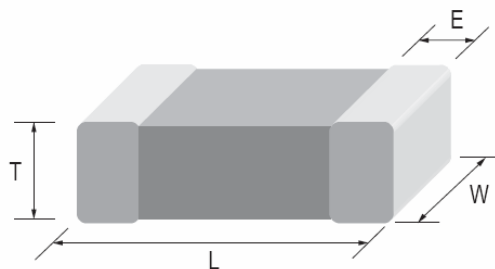

◆ Specification

Part Number	Impedance (Ω)	Test Frequency (MHz)	DCR Max. (Ω)	Rated Current (mA)
CMBM1608 Series				
CMBM1608G050JSP	0~15	100	0.05	800
CMBM1608G300JSP	30±25%	100	0.05	800
CMBM1608G600HSP	60±25%	100	0.10	600
CMBM1608G900HSP	90±25%	100	0.15	600
CMBM1608G121HSP	120±25%	100	0.20	600
CMBM1608G181GSP	180±25%	100	0.25	500
CMBM1608G221GSP	220±25%	100	0.30	500
CMBM1608G301GSP	300±25%	100	0.35	500
CMBM1608G471GSP	470±25%	100	0.45	500
CMBM1608G601GSP	600±25%	100	0.50	500
CMBM1608G102ESP	1000±25%	100	0.60	300
CMBM1608G152CSP	1500±25%	100	0.75	150
CMBM1608K202BSP	2000±25%	100	1.00	100
CMBM1608K222BSP	2200±25%	100	1.00	100
CMBM1608K252BSP	2500±25%	100	1.20	100
CMBM1608K272BSP	2700±25%	100	1.40	100

◆ General Technical Data

Operating Temperature Range	-55℃ ~ +125℃
Storage Condition	Less than 40℃ and 70% RH
Soldering Method	Reflow or Wave Soldering

Recommended Soldering Conditions

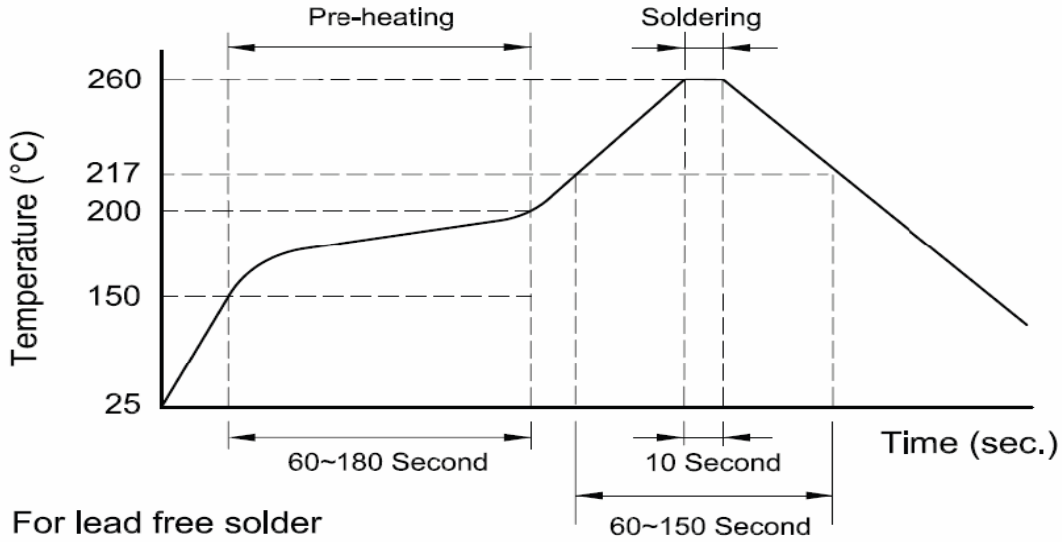

◆ Characteristics

CMBM1608 TYPE

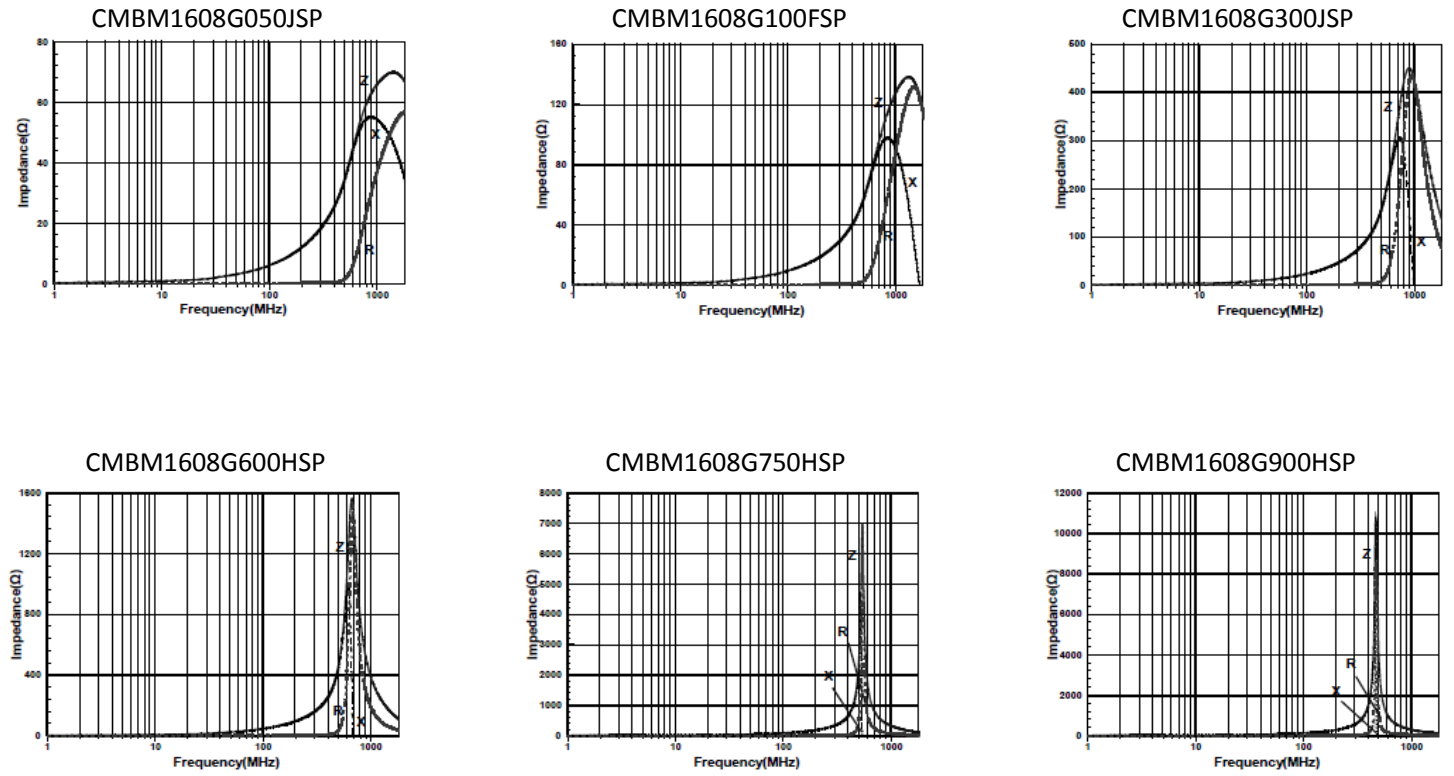

◆ Characteristics

CMBM1608G121HSP

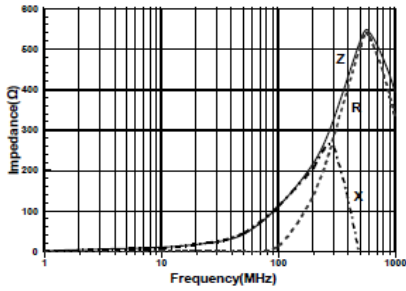

CMBM1608G221GSP

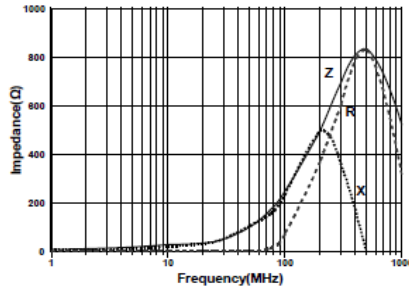

CMBM1608G301GSP

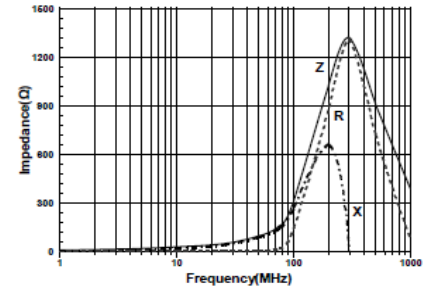

CMBM1608G471GSP

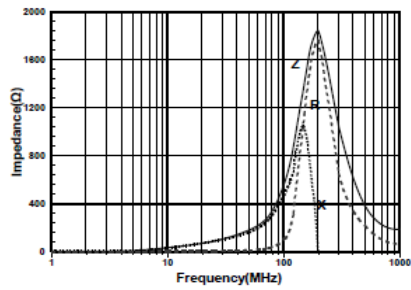

CMBM1608G601GSP

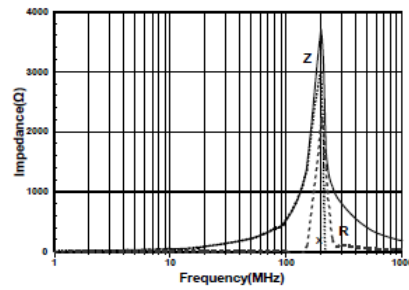

CMBM1608G102ESP

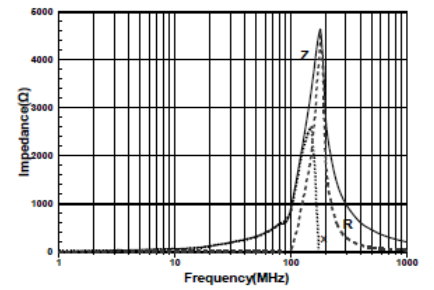

CMBM1608G152KSP

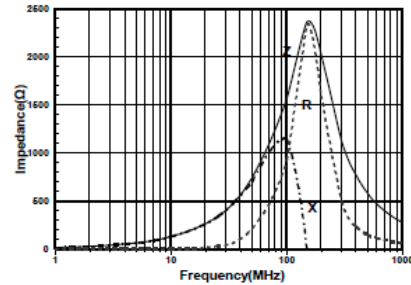

CMBM1608K202BSP

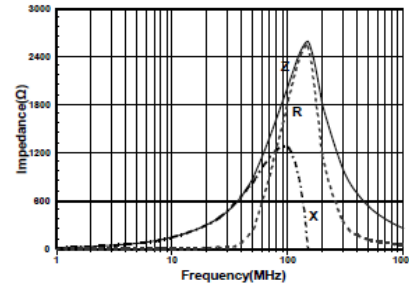

CMBM1608K222BSP

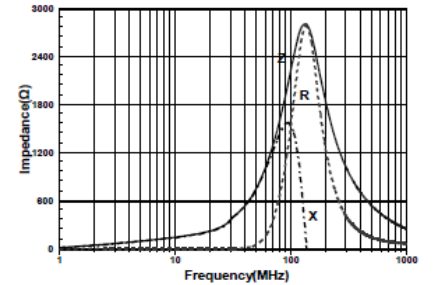

CMBM1608K252BSP

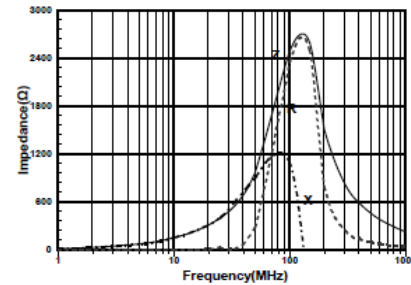

CMBM1608K272BSP

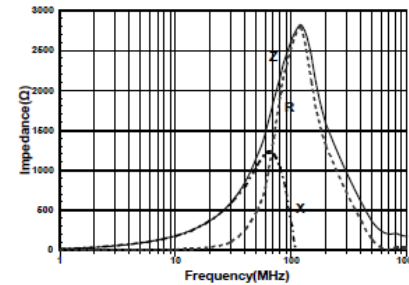

◆ Packaging

Tape Carrier Packaging:

Packaging code: T

- a. Tape carrier packaging are specified in attached figure
- b. Tape carrier packaging quantity please see the following table

Type	1608[0603]
T(mm)	0.9±0.10
Tape	Paper Tape
Quantity	4K

(1) Taping Drawings (Unit: mm)

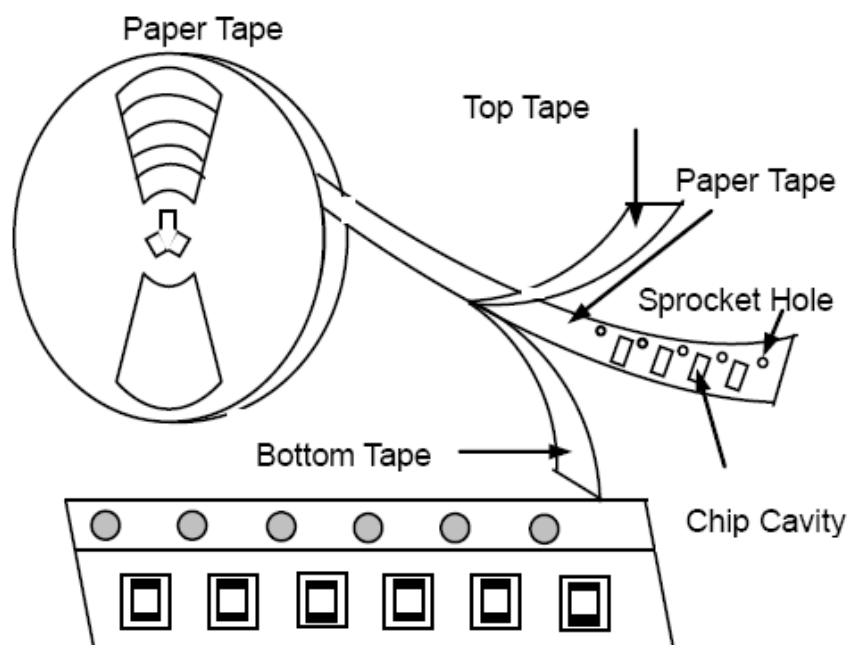

Remark: The sprocket holes are to the right as the tape is pulled toward the user.

(2) Taping Dimensions (Unit: mm)

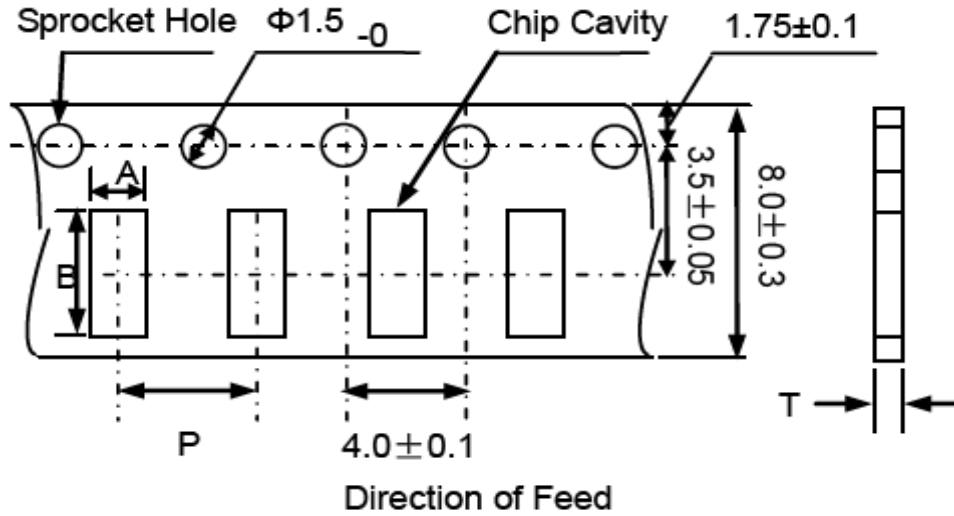

Paper Tape

Type	A	B	P	T max
1608(0603)	1.0 ± 0.2	1.8 ± 0.2	4.0 ± 0.1	1.1

(3) Reel Dimensions (Unit: mm)

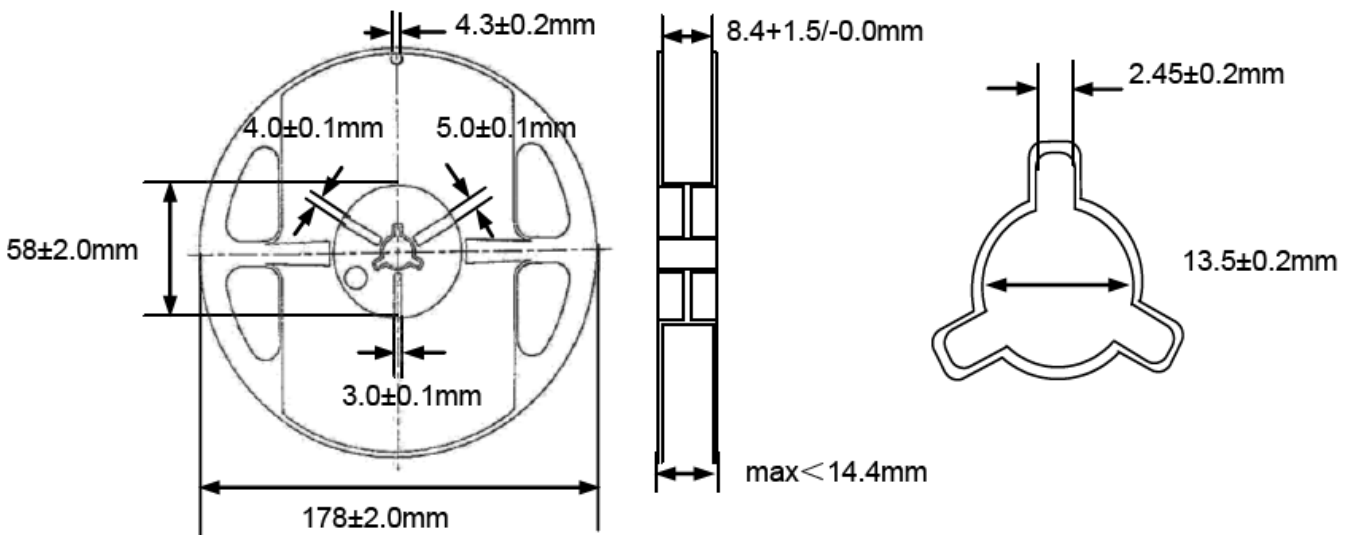

X-ON Electronics

Largest Supplier of Electrical and Electronic Components

Click to view similar products for [Ferrite Beads](#) category:

Click to view products by [Cybermax](#) manufacturer:

Other Similar products are found below :

[2943778301](#) [BMB1J0120BN3JIT](#) [82350120560](#) [0261014605](#) [2643066902](#) [3061000011](#) [2673045901](#) [2643083601](#) [2643074901](#) [4361142521](#)
[4078078621](#) [4078044821](#) [4078033621](#) [CZB2BFTTE121P](#) [BMB2A0120AN2](#) [BMB1J0200BN3JIT](#) [EMI0805R-220](#) [74279250](#) [7427924](#)
[CZB1JGTTD202P](#) [MAF0603GWY551AT000](#) [MAF1005GWZ102AT000](#) [BLM18HE152SH1D](#) [2944778302](#) [BLM02PX600SN1D](#) [SMB2.5-1](#)
[EMI1206R-600](#) [BLM02KX180SN1D](#) [BLM02BC100SN1D](#) [BLM02KX100SN1D](#) [BLM02BB101SN1D](#) [BLM02BC220SN1D](#)
[BLE32PN260SH1L](#) [BLE32PN260SN1L](#) [BLE32PN260SZ1L](#) [74275013](#) [7427503](#) [BLM18HE601SH1D](#) [BLM15BD152SN1D](#)
[BLM15BD152SZ1D](#) [BLE18PS080SZ1D](#) [BLM21PG221BH1D](#) [WLBD1005HCU330TL](#) [BLM21AG471BH1D](#) [BLE18PS080BH1D](#)
[BLM21AG331BH1D](#) [BLM21PG300BH1D](#) [BLM21PG600BH1D](#) [BLM03HB401SZ1D](#) [BLM03HB401SN1D](#)