

Multilayer Chip Ceramic Inductor



◆ **Features**

- 1、 Monolithic Structure for high reliability
- 2、 High self-resonant frequency
- 3、 Excellent solderability and high heat resistance
- 4、 RoHS Compliant.



◆ **Application**

- 1、 RF Circuit of in telecommunication and other Equipments

◆ **PRODUCT IDENTIFICATION**

CMCC 1608 C 2N2 S S P
(1) (2) (3) (4) (5) (6) (7)

- (1) Series Type
- (2) Chip Size (mm) :Length X Width
- (3) Material Code
- (4) Inductance: 1N0=1nH; 10N=10nH
R10=100nH
- (5) Inductance Tolerance: S=±0.3;
J=±5%; K=±10%
- (6) Company Code
- (7) Packaging:P–Embossed paper tape, 7" reel
E- Embossed plastic tape, 7" reel

◆ **Dimensions Unit: mm**

Size(EIA)	L	W	T	E
	1.60±0.150	0.80±0.150	0.80±0.150	0.30±0.200

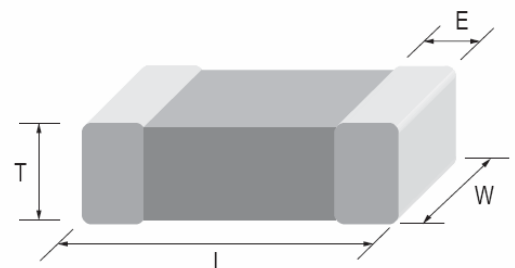

◆ Specifications

Part Number	Inductance (nH)	Min. Quality Factor (Q)	L, Q Test Freq. L/Q(MHz)	Typical Q @ Freq. (MHz)						Min. Self-resonant Frequency (MHz)	Max. DC Resistance (Ω)	Max. Rated Current (mA)
				100	300	500	800	1000	1800			
CMCC1608 Series												
CMCC1608C1N0SSP	1.0±0.3	8	100	12	22	37	38	68	85	6000	0.10	500
CMCC1608C1N2SSP	1.2±0.3	8	100	12	22	37	38	68	85	6000	0.10	500
CMCC1608C1N5SSP	1.5±0.3	8	100	12	22	37	38	68	85	6000	0.10	500
CMCC1608C1N8SSP	1.8±0.3	8	100	12	21	33	35	61	85	6000	0.12	500
CMCC1608C2N2SSP	2.2±0.3	8	100	12	26	40	39	60	85	6000	0.20	500
CMCC1608C2N7SSP	2.7±0.3	8	100	12	23	27	37	47	85	6000	0.20	500
CMCC1608C3N3SSP	3.3±0.3	8	100	12	23	27	36	47	77	6000	0.20	500
CMCC1608C3N9SSP	3.9±0.3	8	100	12	25	28	38	47	73	6000	0.20	500
CMCC1608C4N7SSP	4.7±0.3	8	100	12	26	30	38	49	81	6000	0.20	500
CMCC1608C5N6SSP	5.6±0.3	8	100	12	26	29	35	34	28	5000	0.30	500
CMCC1608C6N8JSP	6.8	8	100	12	23	27	35	40	63	4500	0.30	500
CMCC1608C8N2JSP	8.2	8	100	12	22	26	33	39	50	4000	0.30	500
CMCC1608C10NJSP	10	8	100	14	25	31	38	45	64	3500	0.50	300
CMCC1608C12NJSP	12	8	100	14	24	28	35	39	50	2800	0.50	300
CMCC1608C15NJSP	15	8	100	14	22	27	34	40	45	2300	0.60	300
CMCC1608C18NJSP	18	8	100	14	24	28	35	38	37	2200	0.60	300
CMCC1608C22NJSP	22	8	100	15	27	32	38	43	36	2000	0.60	300
CMCC1608C27NJSP	27	8	100	15	26	29	36	44	25	1700	0.80	300
CMCC1608C33NJSP	33	8	100	15	26	30	35	34	6	1500	0.80	300
CMCC1608C39NJSP	39	8	100	15	22	25	28	28	-	1300	0.80	300
CMCC1608C47NJSP	47	8	100	15	25	29	30	25	-	1200	1.00	300
CMCC1608C56NJSP	56	8	100	15	28	31	31	25	-	1100	1.00	300
CMCC1608C68NJSP	68	8	100	15	22	25	22	15	-	900	1.00	300
CMCC1608C82NJSP	82	8	100	15	23	24	22	-	-	800	1.00	300
CMCC1608CR10JSP	100	8	100	15	25	27	16	-	-	700	1.20	300
CMCC1608CR12JSP	120	8	50	15	24	23	-	-	-	600	1.40	200

◆ Specifications

Part Number	Inductance (nH)	Min. Quality Factor (Q)	L, Q Test Freq. L/Q(MHz)	Typical Q @ Freq. (MHz)						Min. Self-resonant Frequency (MHz)	Max. DC Resistance (Ω)	Max. Rated Current (mA)
				100	300	500	800	1000	1800			
CMCC1608 Series												
CMCC1608CR15JSP	150	8	50	15	19	16	-	-	-	500	1.60	200
CMCC1608CR18JSP	180	8	50	15	18	12	-	-	-	400	1.90	200
CMCC1608CR22JSP	220	8	50	15	16	-	-	-	-	350	2.40	200
CMCC1608CR27JSP	270	8	50	16	18	-	-	-	-	350	2.60	150
CMCC1608CR33JSP	330	8	50	16	16	-	-	-	-	350	2.80	150
CMCC1608CR39JSP	390	8	50	16	-	-	-	-	-	300	3.20	150
CMCC1608CR43JSP	430	8	50	16	-	-	-	-	-	280	3.40	150
CMCC1608CR47JSP	470	8	50	15	-	-	-	-	-	250	3.60	150
CMCC1608CR56JSP	560	8	50	15						250	4.00	100
CMCC1608CR68JSP	680	8	50	15						250	4.50	100

◆ General Technical Data

Operating Temperature Range	-55°C ~ +125°C
Storage Condition	Less than 40°C and 70% RH
Soldering Method	Reflow or Wave Soldering

◆ **Composition / Information on Ingredients**

Product Structure: See Fig.1, Fig. 2 and Fig. 3



Fig.1 Shape

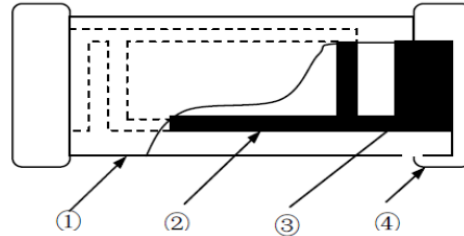

Fig.2 Body Structure

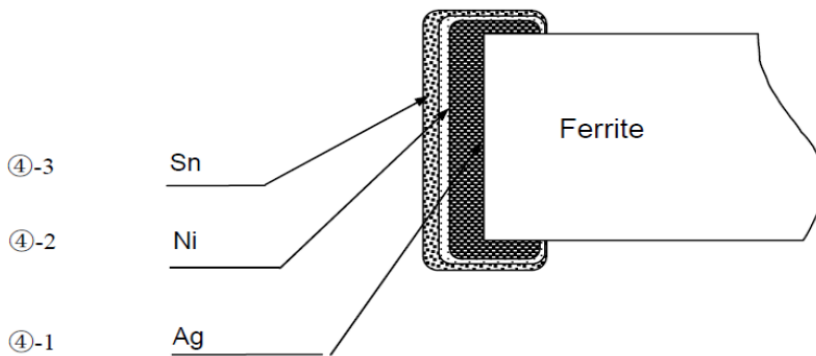

Fig. 3 Structure of Electro-plating

Composition/Information on the Components		
Code	Material	Main Components
①	Ceramic	Boron Silicate, Al ₂ O ₃ , Secret
②	Inner Coil	Silver (Ag)
③	Pull-out Electrode	Silver (Ag)
④-1	Terminal Electrode	Silver (Ag)
④-2	Electrode-plating: Nickel plating	Nickel (Ni)
④-3	Electrode-plating: Sn plating	Tin (Sn)

Compositions Wt Rate (Wt%) of Material		
Material	Wt Rate (Wt%)	CAS No.
Boron Silicate	51~65	65997-18-4
Al ₂ O ₃	14~17	1344-28-1
Secret	0~5	-
Ag	9~29	7440-22-4
Nickel	1.8~2.3	7440-02-0
Tin	3.6~4.7	7440-31-5

◆ TYPICAL ELECTRICAL CHARACTERISTICS

CMCC1608 Series

Inductance vs. Frequency Characteristics

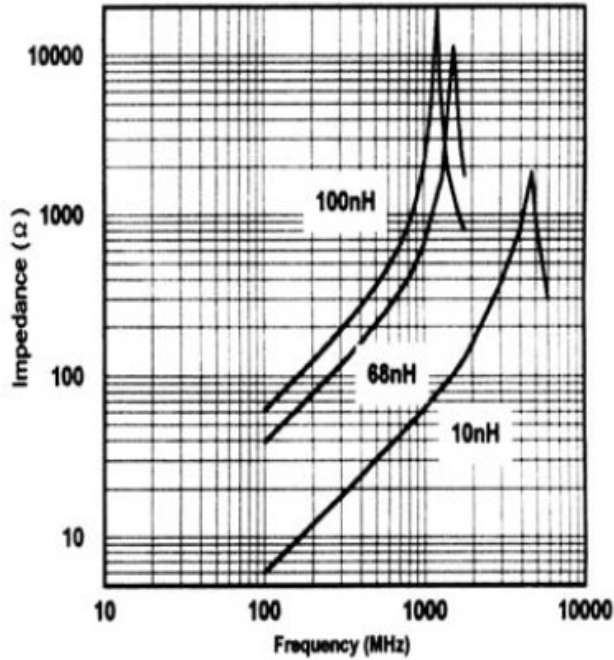

Impedance vs. Frequency Characteristics

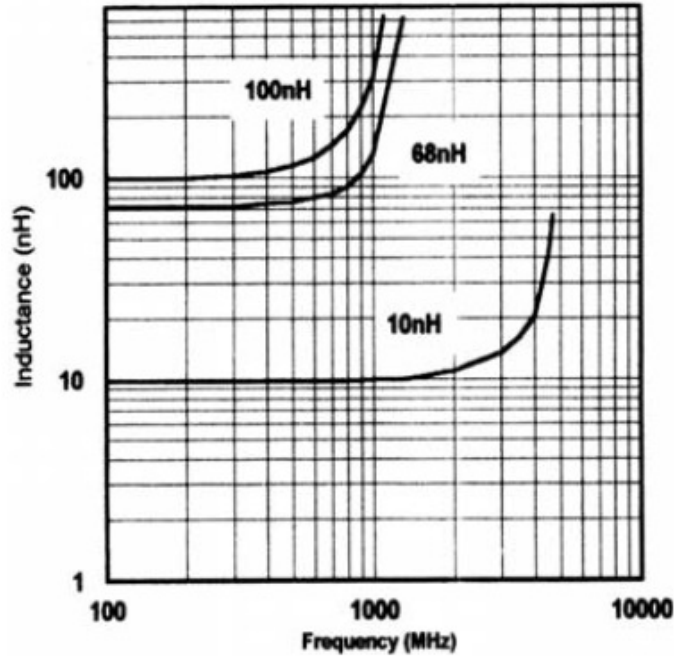

Q vs. Frequency Characteristics

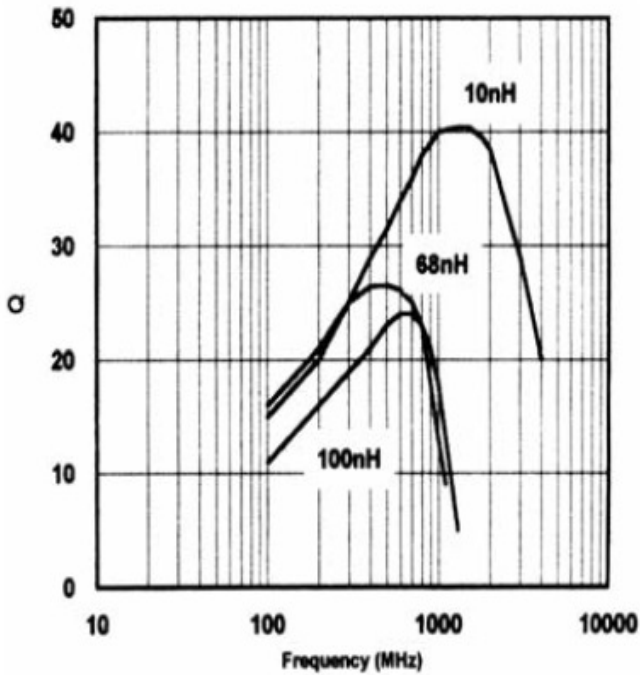

◆ Packaging

(1) Taping Drawings (Unit: mm)

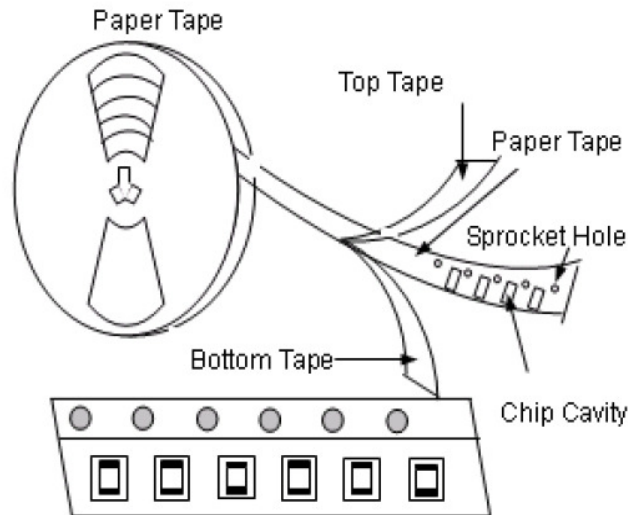

Remark: The sprocket holes are to the right as the tape is pulled toward the user.

(2) Taping Dimensions (Unit: mm)

Sprocket Hole $\Phi 1.5 (+0.1, 0)$

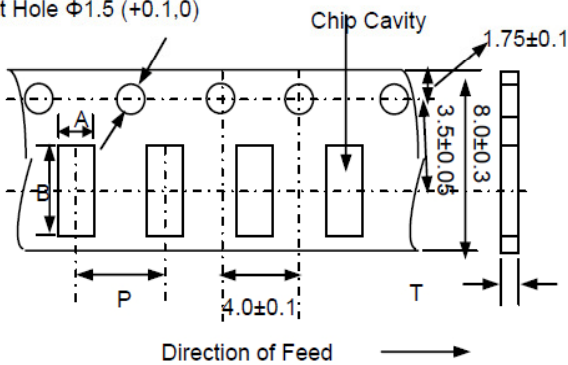

Paper Tape

Type	A	B	P	T max	Quantity
1608(0603)	1.0 ± 0.2	1.8 ± 0.2	4.0 ± 0.1	1.1	4K

(3) Reel Dimensions (Unit: mm)

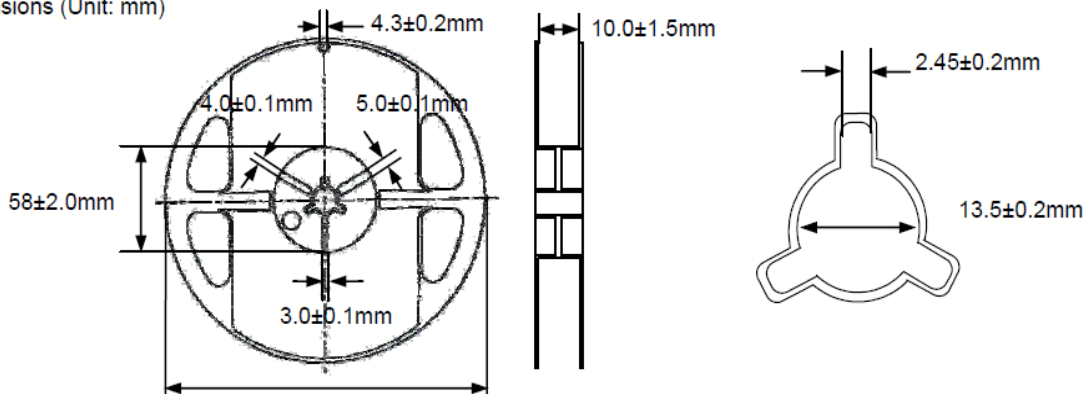

X-ON Electronics

Largest Supplier of Electrical and Electronic Components

Click to view similar products for [Fixed Inductors](#) category:

Click to view products by [Cybermax](#) manufacturer:

Other Similar products are found below :

[MLZ1608M6R8WTD25](#) [MLZ1608N6R8LT000](#) [MLZ1608N3R3LTD25](#) [MLZ1608N3R3LT000](#) [MLZ1608N150LT000](#)

[MLZ1608M150WTD25](#) [MLZ1608M3R3WTD25](#) [MLZ1608M3R3WT000](#) [MLZ1608M150WT000](#) [MLZ1608A1R5WT000](#)

[MLZ1608N1R5LT000](#) [B82432C1333K000](#) [PCMB053T-1R0MS](#) [PCMB053T-1R5MS](#) [PCMB104T-1R5MS](#) [CR32NP-100KC](#) [CR32NP-](#)

[151KC](#) [CR32NP-180KC](#) [CR32NP-181KC](#) [CR32NP-1R5MC](#) [CR32NP-390KC](#) [CR32NP-3R9MC](#) [CR32NP-680KC](#) [CR32NP-820KC](#)

[CR32NP-8R2MC](#) [CR43NP-390KC](#) [CR43NP-560KC](#) [CR43NP-680KC](#) [CR54NP-181KC](#) [CR54NP-470LC](#) [CR54NP-820KC](#) [CR54NP-8R5MC](#)

[MGDQ4-00004-P](#) [MGDU1-00016-P](#) [MHL1ECTTP18NJ](#) [MHL1JCTTD12NJ](#) [PE-51506NL](#) [PE-53601NL](#) [PE-53630NL](#) [PE-53824SNLT](#) [PE-](#)

[62892NL](#) [PE-92100NL](#) [PG0434.801NLT](#) [PG0936.113NLT](#) [PM06-2N7](#) [PM06-39NJ](#) [HC2LP-R47-R](#) [HC2-R47-R](#) [HC3-2R2-R](#) [HC8-1R2-R](#)